

Marking of thermal cut-outs type: AM, AB, AC, AD, AA.

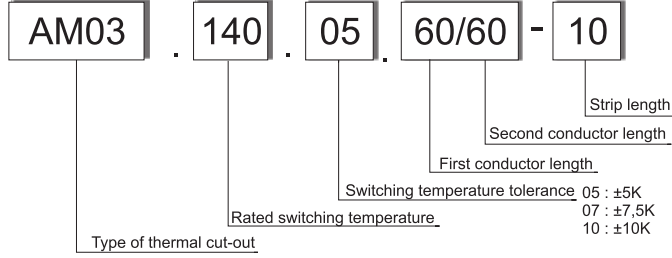

Marking of thermal cut-outs type: AH, AK, AS.

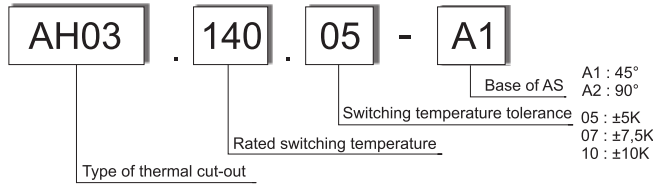

Marking of thermal cut-outs type: AR.

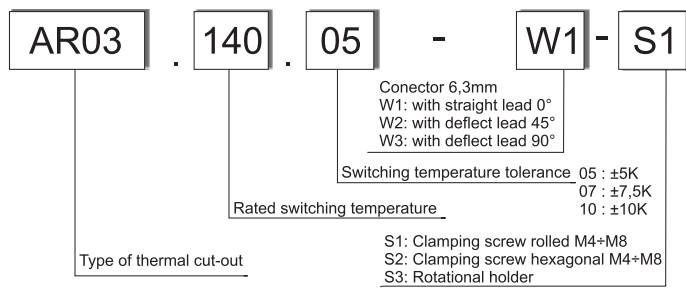

Options:

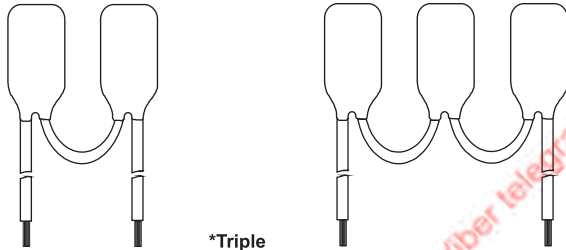

*Double

*Triple

* non-standard temperatures acc. to customer requirements

Contact configuration - abbreviations

- n.c. normally closed
- n.o. normally open
- SPST single-pole single-throw
- DPST double-pole single-throw
- 3PST triple-pole single-throw

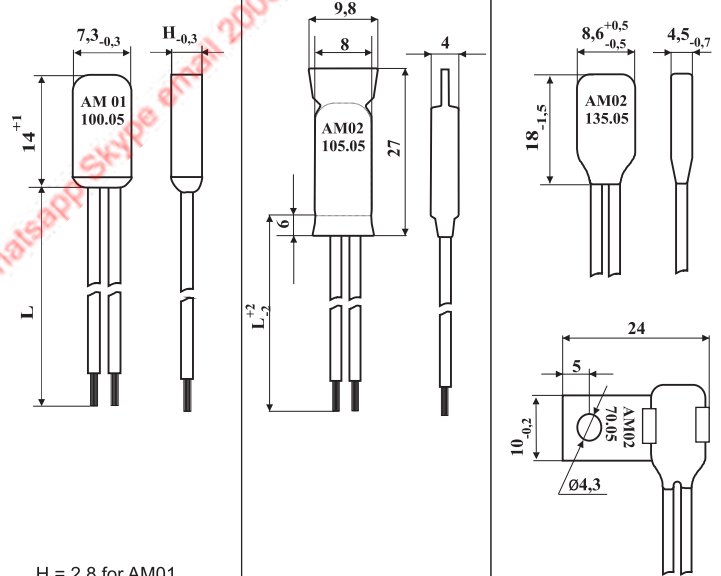
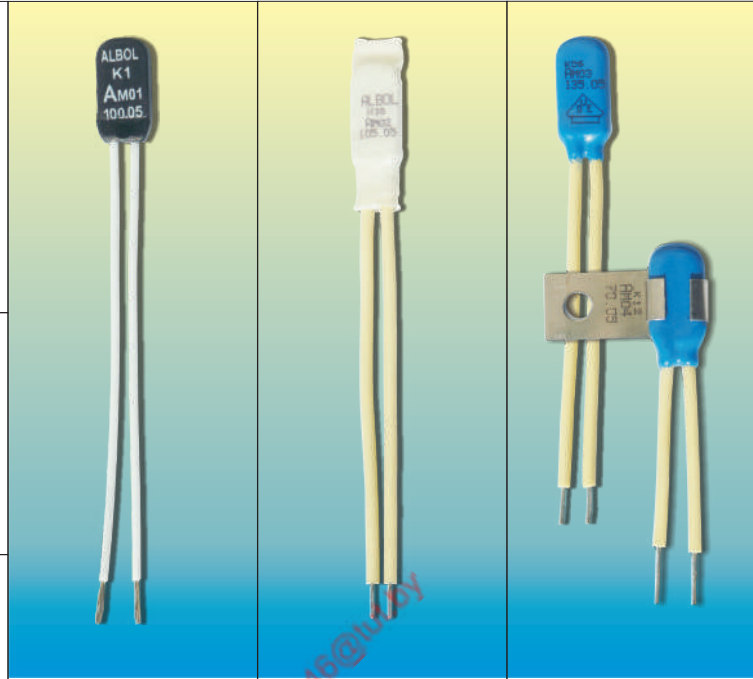

H = 2,8 for AM01
H = 3,3 for AM01*

	Technical data	Type of thermal cut-out	AM01 AM01*	AM02	AM03 AM04
1	Contact configuration		SPST n.c.	SPST n.c.	SPST n.c.
2	Rated voltage		250V; AC	250V; AC	250V; AC
3	Rated current of resistance loading $I_{zn}, \cos\varphi = 1,0$ of resistance and induction loading $I_x, \cos\varphi = 0,6$		2,5 A 1,6 A	2,5 A 1,6 A	2,5 A 1,6 A
4	Number of switching cycles at rated loading		10 000 cycles	10 000 cycles	10 000 cycles
5	Maximum loading / number of automatic cycles		3,6 A / 2000 cycles	3,6 A / 2000 cycles	3,6 A / 2000 cycles
6	Range of rated switching temperatures		65°C - 130°C 65°C - 150°C*	65°C - 150°C	65°C - 150°C
7	Switching temperature tolerance		±5K/±7,5K/±10K	±5K/±7,5K/±10K	±5K/±7,5K/±10K
8	Switching differential		30 ± 15 K	30 ± 15 K	30 ± 15 K
9	Speed of temperature changes		0,5 ÷ 1 K / min	0,5 ÷ 1 K / min	0,5 ÷ 1 K / min
10	Degree of pollution (acc. to EN-60730-1)		2	2	2
11	Thermal resistance		max 170°C 190°C* / 1 min	max 190°C / 1 min	max 190°C / 1 min
12	Degree of protection		IP 00	IP 00	IP 00
13	PTI of material used for insulation		250 V	250 V	250 V
14	Construction		incorporated; non-electronic	incorporated; non-electronic	incorporated; non-electronic
15	Electrical strength of insulation		1 000 V 2000 V*; 50 Hz	2 500 V; 50 Hz	2 500 V; 50 Hz
16	Contact resistance		max ≤ 40 mΩ	max ≤ 40 mΩ	max ≤ 40 mΩ
17	Approvals acc. to design for		VDE, UL, BEAB	VDE, UL, BEAB	VDE, UL, BEAB

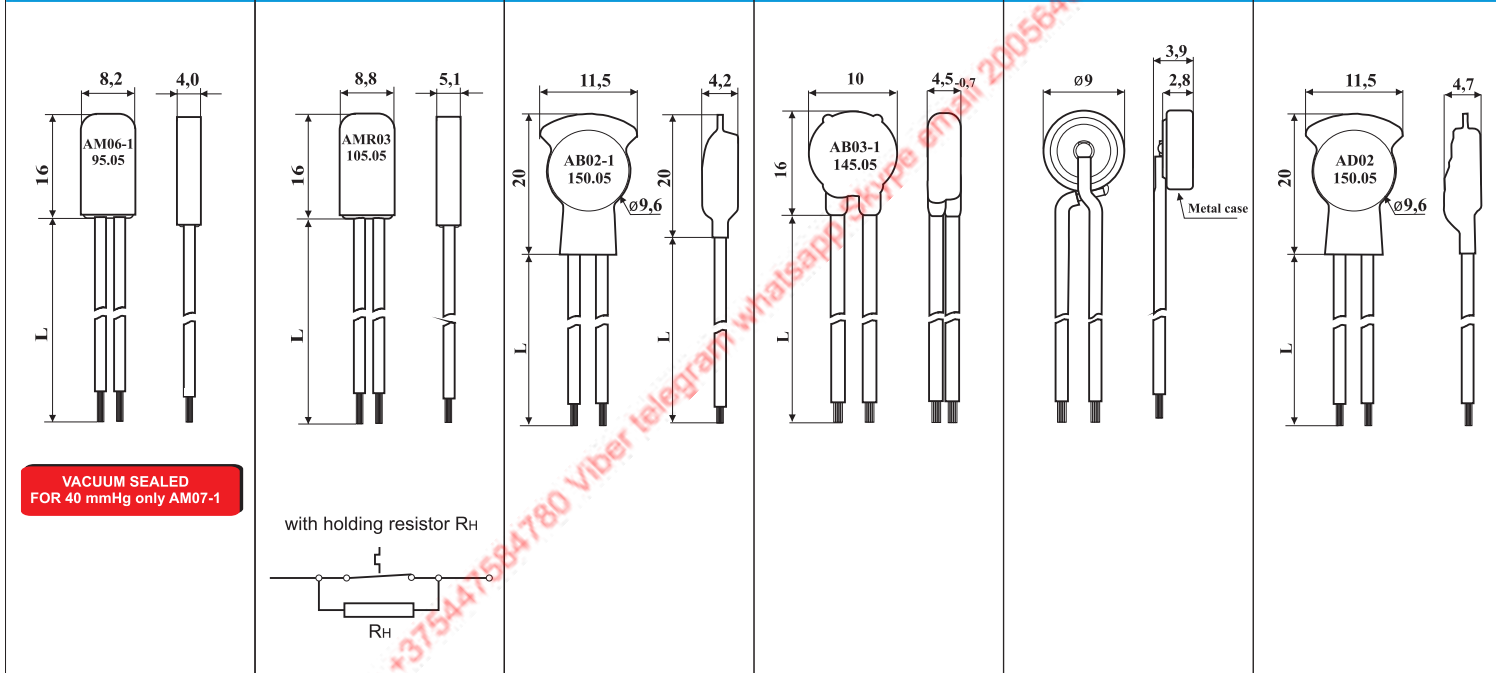

	AM06 AM07-1	AMR03	AB02-1	AB03-1	AD01	AD02
1	SPST n.c.	SPST n.c.	SPST n.c.	SPST n.c.	SPST n.c.	SPST n.c.
2	250V; AC	250V; AC	250V; AC	250V; AC	250V; AC	250V; AC
3	2,5 A 1,6 A	2,5 A 1,6 A	2,5 A 1,6 A	2,5 A 1,6 A	2,5 A 1,6 A	2,5 A 1,6 A
4	10 000 cycles	3 000 cycles	10 000 cycles	10 000 cycles	10 000 cycles	10 000 cycles
5	3,6 A / 2000 cycles	3,6 A / 2000 cycles	3,6 A / 2000 cycles	3,6 A / 2000 cycles	3,6 A / 2000 cycles	3,6 A / 2000 cycles
6	65°C - 160°C	65°C - 150°C	65°C - 160°C	65°C - 150°C	65°C - 180°C	65°C - 160°C
7	±5K/±7,5K/±10K	±5K/±7,5K/±10K	±5K/±7,5K/±10K	±5K/±7,5K/±10K	±5K/±7,5K/±10K	±5K/±7,5K/±10K
8	30 ± 15 K	voltage maintained	30 ± 15 K	30 ± 15 K	30 ± 15 K	30 ± 15 K
9	0,5 ÷ 1 K / min	0,5 ÷ 1 K / min	0,5 ÷ 1K / min	0,5 ÷ 1K / min	0,5 ÷ 1K / min	0,5 ÷ 1K / min
10	2	2	2	2	2	2
11	max 230°C / 1 min	max 190°C / 1 min	max 230°C / 1 min	max 230°C / 1 min	max 190°C / 1 min	max 190°C / 1 min
12	IP 54 IP68	IP 00	IP 00	IP 00	IP 00	IP 00
13	250 V	250 V	250 V	250 V	250 V	250 V
14	incorporated; non-electronic	incorporated; non-electronic	incorporated; non-electronic	incorporated; non-electronic	incorporated; non-electronic	incorporated; non-electronic
15	2 500 V; 50 Hz	2 500 V; 50 Hz	2 500 V; 50 Hz	2 500 V; 50 Hz	-----	2 500 V; 50 Hz
16	max ≤ 40 mΩ	max ≤ 40 mΩ	max ≤ 40 mΩ	max ≤ 40 mΩ	max ≤ 40 mΩ	max ≤ 40 mΩ
17	BEAB, ENEC	UL	VDE in progress			

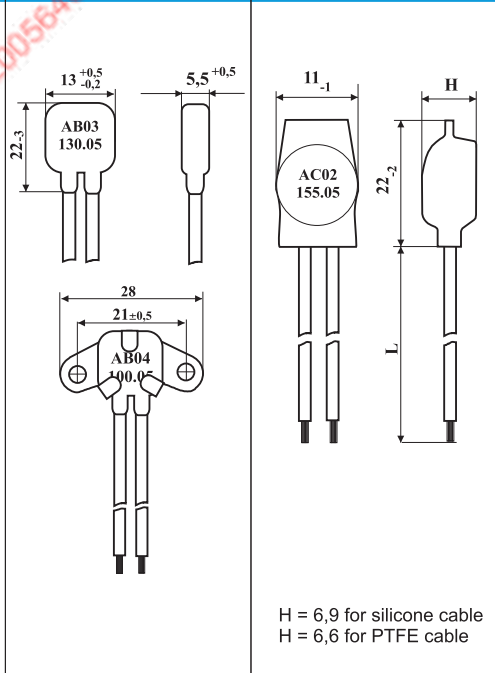
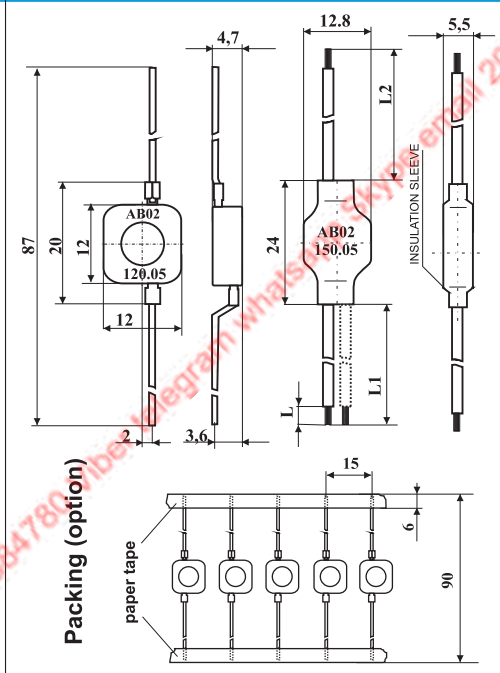
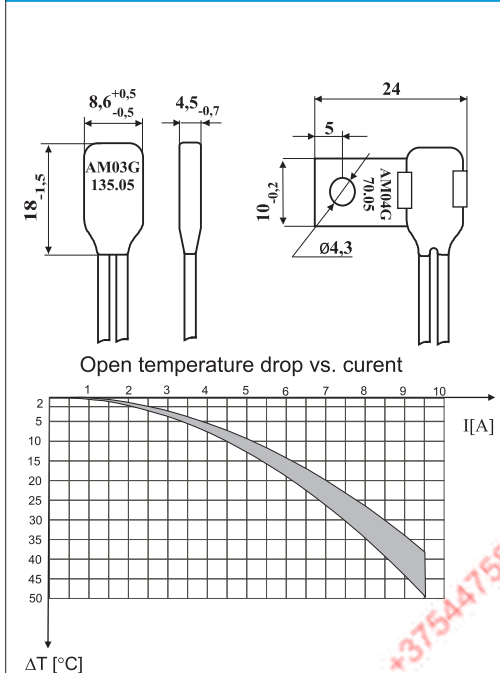
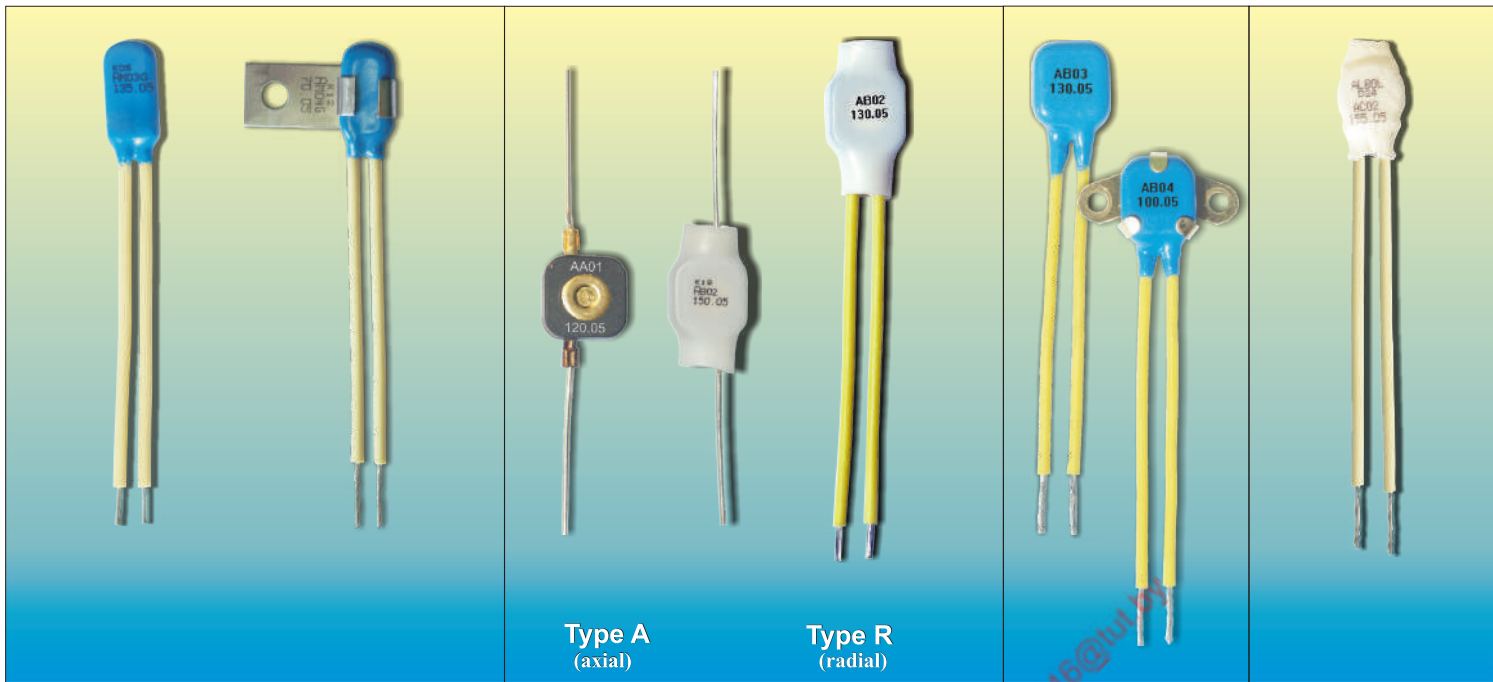

	AM03G AM04G	AB01 AB02	AB03 AB04	AC02
1	SPST n.c.	SPST n.c.	SPST n.c.	SPST n.c.
2	250V; AC	250V; AC	250V; AC	250V; AC
3	4,5 A 1,6 A	6,3 A 4,0 A	6,3 A 4,0 A	6,3 A 4,0 A
4	10 000 cycles	10 000 cycles	10 000 cycles	10 000 cycles
5	6 A / 2000 cycles	10 A / 2000 cycles	10 A / 2000 cycles	10 A / 2000 cycles
6	65°C - 150°C	65°C - 150°C	65°C - 150°C	65°C - 180°C
7	±5K/±7,5K/±10K	±5K/±7,5K/±10K	±5K/±7,5K/±10K	±5K/±7,5K/±10K
8	30 ± 15 K	30 ± 15 K	30 ± 15 K	30 ± 15 K
9	0,5 ÷ 1 K / min	0,5 ÷ 1 K / min	0,5 ÷ 1 K / min	0,5 ÷ 1 K / min
10	2	2	2	2
11	max 190°C / 1 min	max 230°C / 1 min	max 230°C / 1 min	max 190°C / 1 min
12	IP 00	IP 00	IP 00	IP 00
13	250 V	250 V	250 V	250 V
14	incorporated; non-electronic	incorporated; non-electronic	incorporated; non-electronic	incorporated; non-electronic
15	2 500 V; 50 Hz	----- 2 500 V ; 50Hz	2 500 V; 50 Hz	2 500 V; 50 Hz
16	max ≤ 40 mΩ	max ≤ 25 mΩ	max ≤ 25 mΩ	max ≤ 25 mΩ
17				VDE, UL

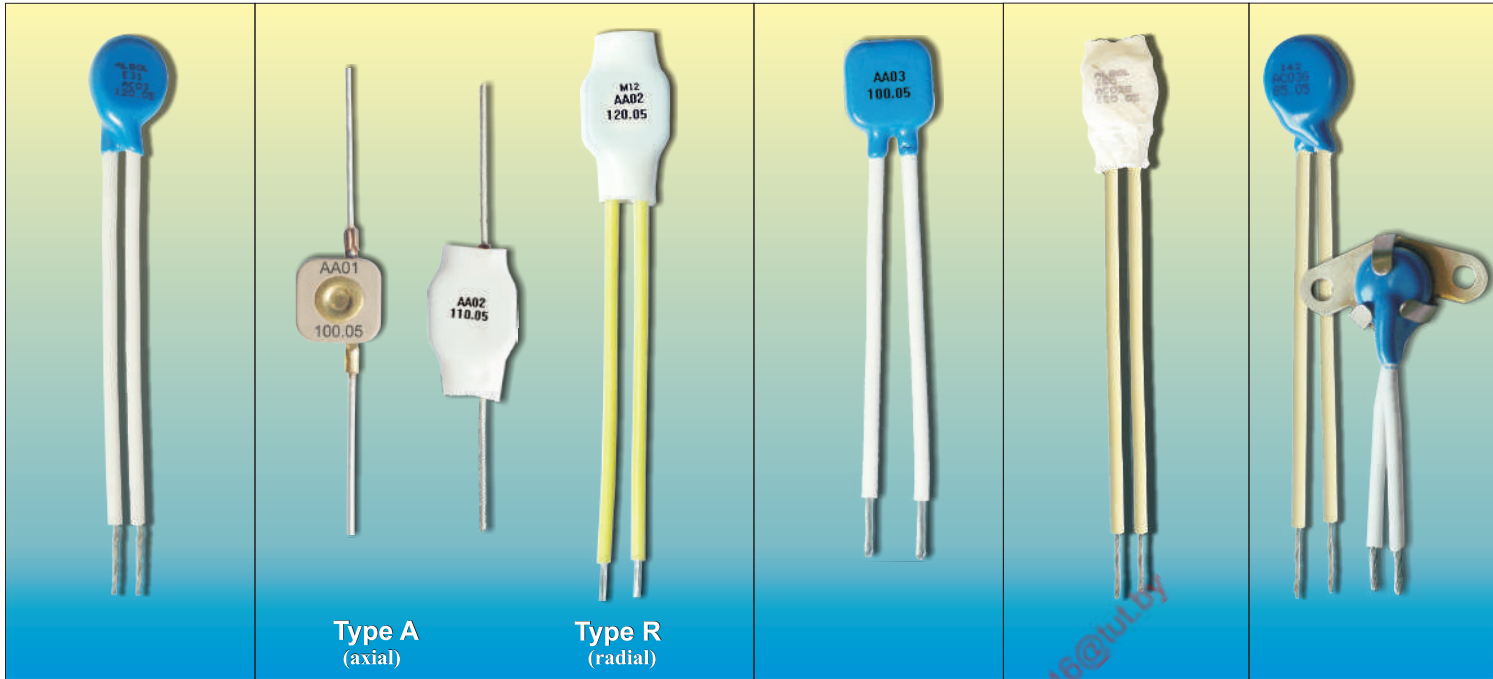

Type A
(axial)

Type R
(radial)

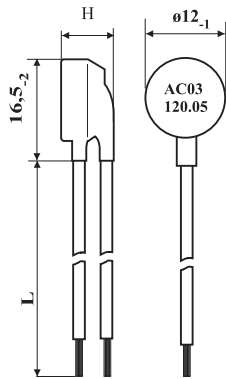

H = 7,7 for silicone cable
H = 7,2 for PTFE cable

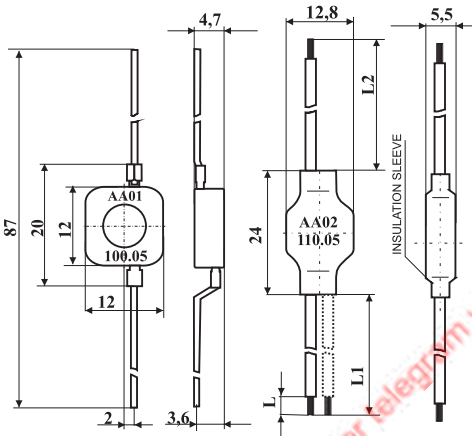

Packing (option)

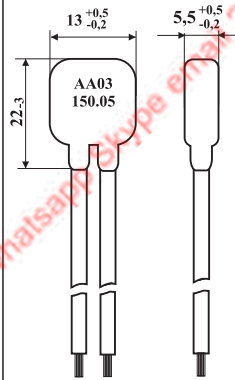
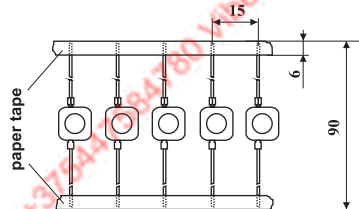

H = 7,2 for silicone cable
H = 6,9 for PTFE cable

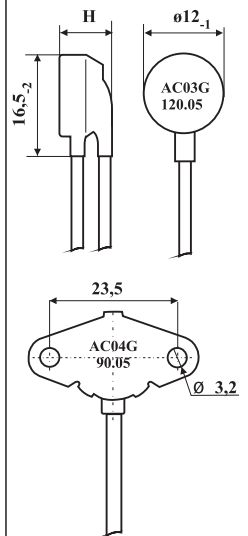

H = 8 for silicone cable
H = 7,5 for PTFE cable

	AC03	AA01 AA02	AA03	AC02G	AC03G AC04G
1	SPST n.c.	SPST n.c.	SPST n.c.	SPST n.c.	SPST n.c.
2	250V; AC	250V; AC	250V; AC	250V; AC	250V; AC
3	6,3 A 4,0 A	13A 6,0A	13 A 6,0 A	13 A 6,0 A	13 A 6,0 A
4	10 000 cycles		10 000 cycles	10 000 cycles	10 000 cycles
5	10 A / 2000 cycles	10 A / 2000 cycles	16 A / 2000 cycles	16 A / 2000 cycles	16 A / 2000 cycles
6	65°C - 150°C	65°C - 150°C	65°C - 150°C	65°C - 180°C	65°C - 160°C
7	±5K/±7,5K/±10K	±5K/±7,5K/±10K	±5K/±7,5K/±10K	±5K/±7,5K/±10K	±5K/±7,5K/±10K
8	30 ± 15 K	30 ± 15 K	30 ± 15 K	30 ± 15 K	30 ± 15 K
9	0,5 ÷ 1 K / min	0,5 ÷ 1 K / min	0,5 ÷ 1 K / min	0,5 ÷ 1 K / min	0,5 ÷ 1 K / min
10	2	2	2	2	2
11	max 190°C / 1 min	max 230°C / 1 min	max 230°C / 1 min	max 190°C / 1 min	max 190°C / 1 min
12	IP 00	IP 00	IP 00	IP 00	IP 00
13	250 V	250 V	250 V	250 V	250 V
14	incorporated; non-electronic	incorporated; non-electronic	incorporated; non-electronic	incorporated; non-electronic	incorporated; non-electronic
15	2 500 V; 50 Hz	----- 2 500 V ; 50Hz	2 500 V; 50 Hz	2 500 V; 50 Hz	2 500 V; 50 Hz
16	max ≤ 25 mΩ	max ≤ 25 mΩ	max ≤ 15 mΩ	max ≤ 15 mΩ	max ≤ 15 mΩ
17	VDE				VDE

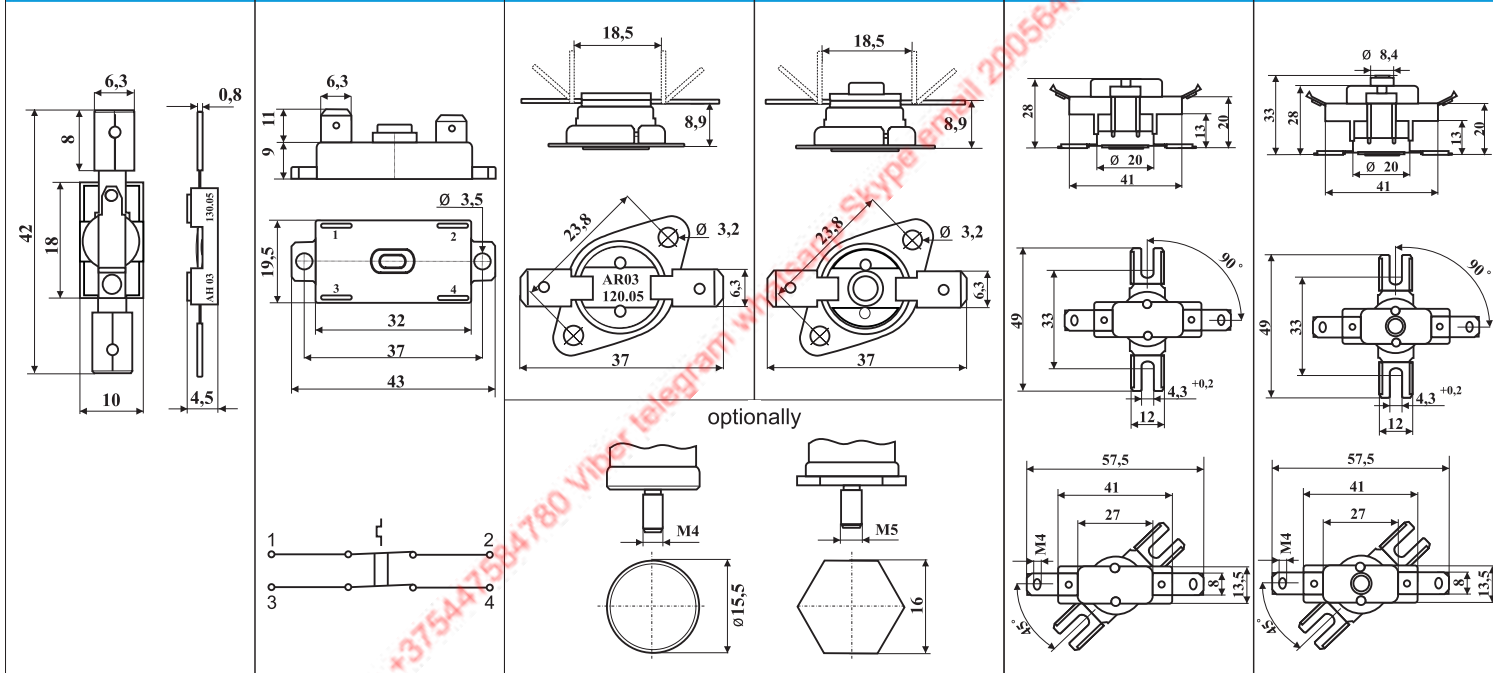
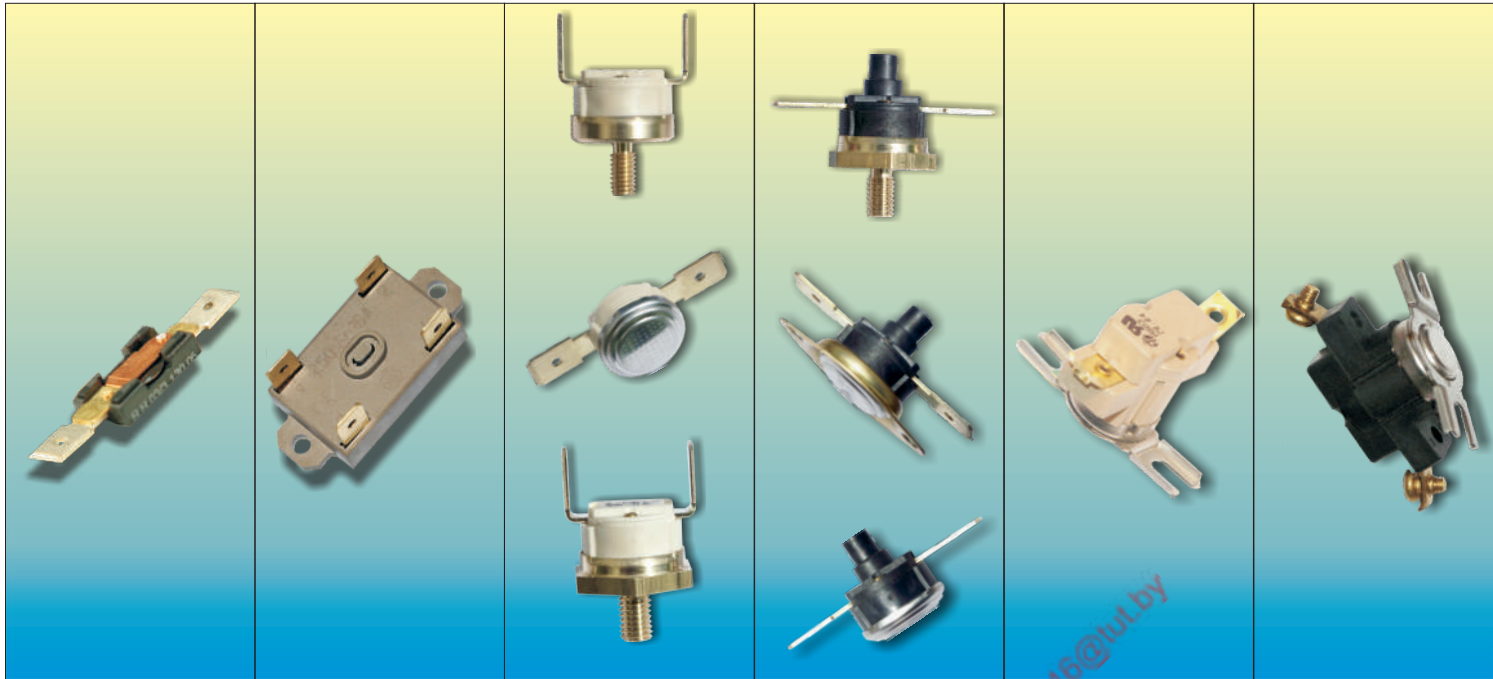



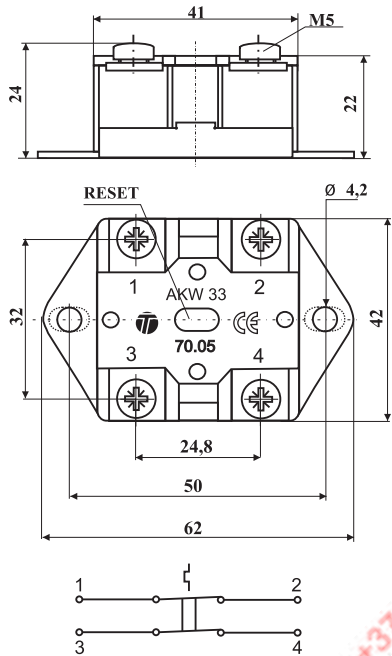

	AH03/3	AK33	AR03	AR33	AS03	AS33
1	SPST n.c.	DPST n.c.	SPST n.c.	SPST n.c.	SPST n.c.	SPST n.c.
2	250V; AC	250V; AC	250V; AC	250V; AC	250V; AC	max 400V; AC
3	13 A 2,5 A	16 A per each line 6,0 A per each line	16 A 6,0 A	16 A 6,0 A	25A/250 V	25A/250 V; 15A/400 V 16A/250 V; 10A/400 V
4	10 000 cycles	10 000 cycles	3 000 cycles	3 000 cycles	6 000 cycles	10 000 cycles
5	16 A / 2000 cycles	20 A / 200 cycles	20 A / 200 cycles	20 A / 200 cycles	40 A / 50 cycles	32 A / 200 cycles
6	65°C - 150°C	65°C - 150°C	50°C - 180°C	50°C - 180°C	60°C - 180°C	60°C - 180°C
7	±5K/±7,5K/±10K	±5K/±7,5K/±10K	±5K/±7,5K/±10K	±5K/±7,5K/±10K	±5K/±7,5K/±10K	±5K/±7,5K/±10K
8	30 ± 15 K	manual reset	30 ± 15 K	manual reset	30 ± 15 K	manual reset
9	0,5 ÷ 1 K / min	0,5 ÷ 1 K / min	0,5 ÷ 1 K / min	0,5 ÷ 1 K / min	0,5 ÷ 1 K / min	0,5 ÷ 1 K / min
10	2	2	2	2	2	2
11	max 230°C / 1 min	max 260°C / 1 min	max 260°C / 1 min	max 260°C / 1 min	max 260°C / 1 min	max 260°C / 1 min
12	IP 00	IP 00	IP 00	IP 00	IP 00	IP 00
13	250 V	250 V	250 V	250 V	250 V	250 V
14	incorporated; non-electronic	incorporated; non-electronic	incorporated; non-electronic	incorporated; non-electronic	incorporated; non-electronic	incorporated; non-electronic
15	-----	2 500 V; 50 Hz	2 500 V; 50 Hz*	2 500 V; 50 Hz*	2 500 V; 50 Hz*	3750 V; 50 Hz*
16	max ≤ 40 mΩ	max ≤ 40 mΩ	max ≤ 20 mΩ	max ≤ 20 mΩ	max ≤ 20 mΩ	max ≤ 20 mΩ
17			VDE	VDE	UL	

*from cup to the terminal

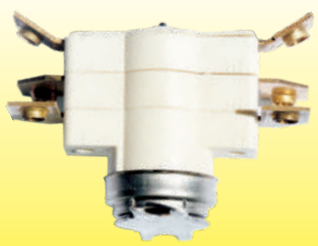

AKW33	
1	DPST n.c.
2	max 400V; AC
3	32A/400 V 10A/400 V
4	300 cycles
5	42A / 30 cycles
6	65°C - 150°C
7	±5K/±7,5K/±10K
8	manual reset
9	0,5 ÷ 1 K / min
10	2
11	max 260°C / 1 min
12	IP 00
13	250 V
14	incorporated; non-electronic
15	3750 V; 50 Hz
16	max ≤ 40 mΩ
17	

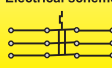
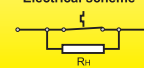
ADDITIONAL OPTIONS

	AST33	ASR44	ASR44G
			
	Electrical scheme 	Electrical scheme 	Electrical scheme 
1	3PST n.c.	SPST n.c.	SPST n.c.
2	max 400V; AC	115V AC; 230V AC; 24V,48V AC, DC	115V AC; 230V AC; 24V,48V AC, DC
3	40A (300 cycles)	16A	25A
6	65°C - 150°C	65°C - 175°C	65°C - 175°C
8	manual reset	not higher than: -20°C	not higher than: -20°C
12	IP 00	IP 00	IP 00
15	2500V; 50Hz	2500 V	2500 V

OTHER PRODUCTS

Thermal fuses

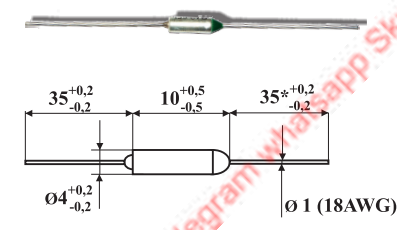

Thermal links

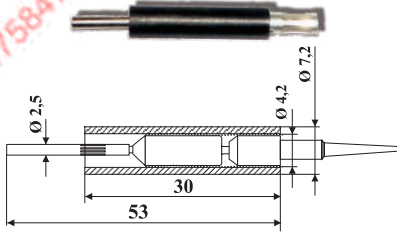

Approved Applied

TEMPERATURE Ratings

Cat No.	Tf [°C]	Cutoff temperature	Th [°C]	K MARK	UL	C-UL	VDE	TUV	CCC	PSE
SW-102T	72	72°C +2°C, -2°C	57							
SW-105T	77	77°C +0°C, -4°C	62							
SW-109T*	84	84°C +0°C, -5°C	57							
SW-104T	98	98°C +2°C, -2°C	73							
SW-108T*	100	100°C +0°C, -5°C	75							
SW-110T*	109	109°C +0°C, -5°C	84							
SW-111T	121	121°C +0°C, -5°C	94							
SW-115T	126	126°C +0°C, -4°C	100							
SW-129T	128	128°C +0°C, -5°C	103							
SW-114T*	139	139°C +0°C, -4°C	114							
SW-138T	144	144°C +0°C, -5°C	119							
SW-116T	152	152°C +0°C, -4°C	127							
SW-120T	167	167°C +0°C, -4°C	144							
SW-118T	169	169°C +0°C, -4°C	144							
SW-127T	184	184°C +0°C, -6°C	159							
SW-122T	192	192°C +3°C, -3°C	162							
SW-125T	195	195°C +0°C, -6°C	165							
SW-139T	216	216°C +0°C, -6°C	178							
SW-124T	228	228°C +0°C, -6°C	187							
SW-128T*	240	240°C +0°C, -6°C	193							

UL file NO: E126429, MITI : 33-890, -942, -945, -940, -941, -943, -944, JET1054-32001-1002, -1001
 *SW-108T, 109T,110T,114T,128T Dual Retings UL, VDE approved 250V 10A and 125V 10A and 125V 15A(VDE:250V 15A)

Multiple connectors

Multiple connectors for printed boards, used in radio - TV equipment. These connectors are intended for indirect connections between circuits of electronic equipment, allowing building of connection system of type wire-board and board-board in 2,54 mm or 5mm raster. In systems of wire-board the most suitable for connection are conductors with wire cross-section of 0,12 to 0,20 mm². Maximum working voltage 60V.

