

PIZZATO NF концевой выключатель **Минск** тел. **+375447584780**
www.fotorele.net www.tiristor.by радиодетали, электронные компоненты
email minsk17@tut.by tel.+375 29 758 47 80 МТС

Мы не работаем с частными (физическими) лицами.

Мы работаем только с юридическими лицами(организациями) и ИП и только по безналичному расчёту.

каталог, описание, технические, характеристики, datasheet, параметры, маркировка, габариты, фото, преобразователь, конвертор, dc-dc,
QR код



PIZZATO ELETTRICA NF B110BB-DMK / Limit switch; pusher
with parallel roller; NO + NC; IP67

Selection diagram for NF series items sold assembled

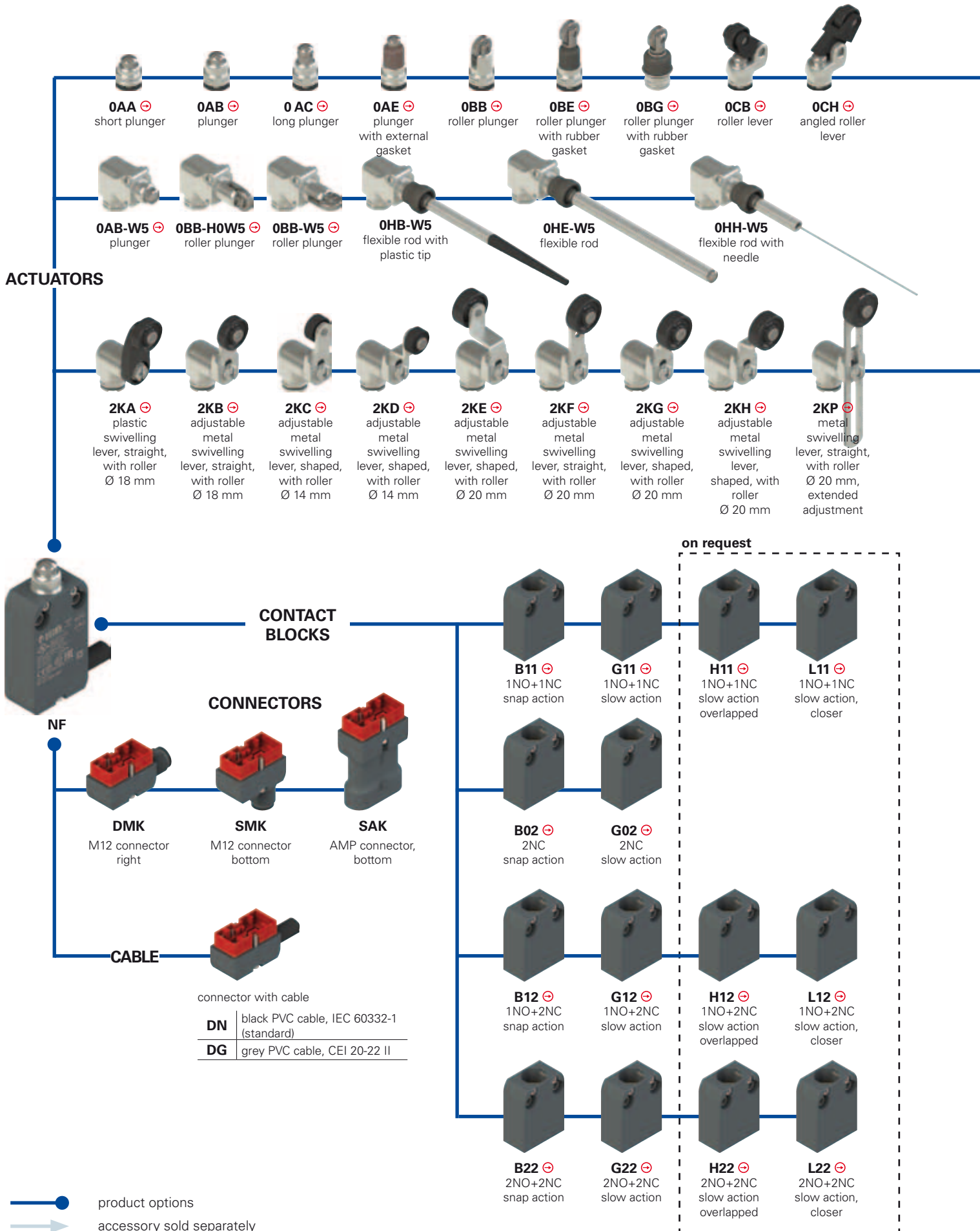

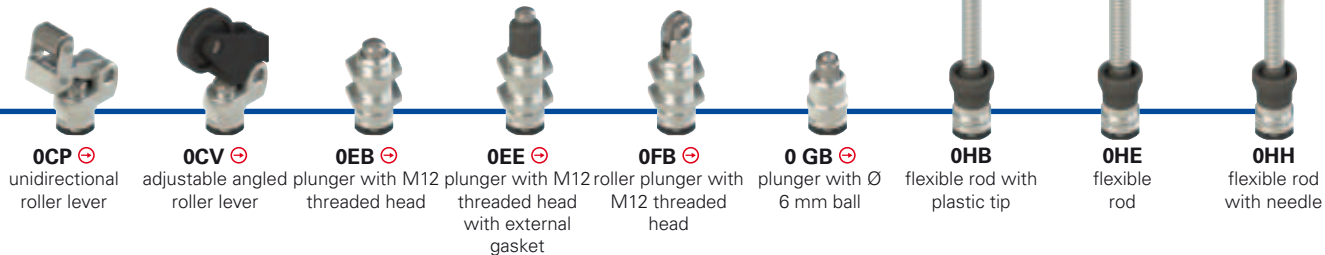

OCP ⊖ unidirectional roller lever
OCV ⊖ adjustable angled roller lever
OEB ⊖ adjustable plunger with M12 threaded head
OEE ⊖ plunger with M12 threaded head with external gasket
OFB ⊖ roller plunger with M12 threaded head
OGB ⊖ plunger with Ø 6 mm ball
OHB flexible rod with plastic tip
OHE flexible rod
OHH flexible rod with needle

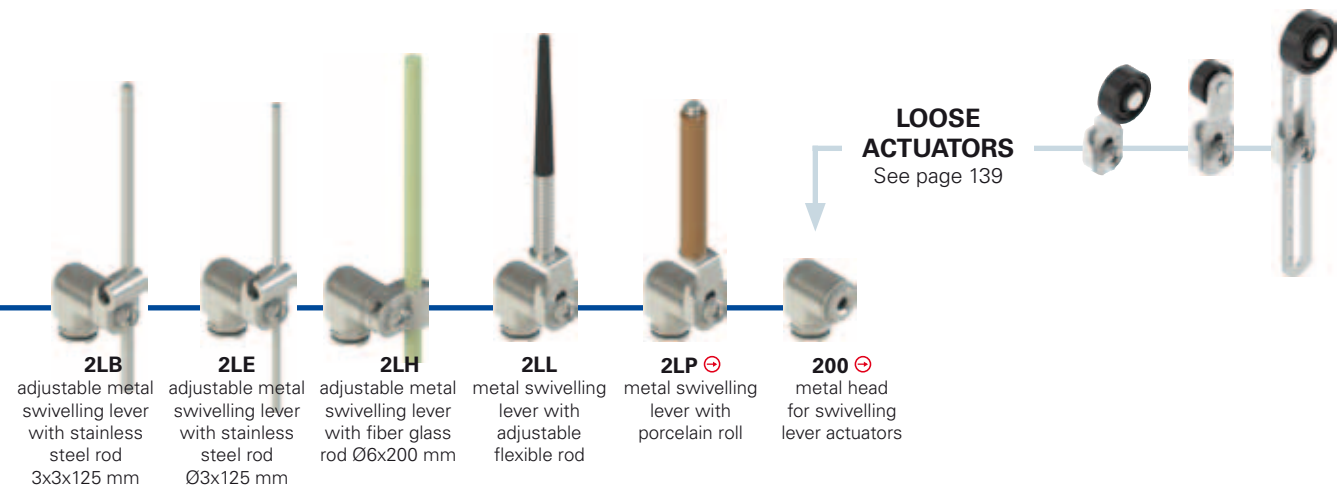

2LB adjustable metal swivelling lever with stainless steel rod 3x3x125 mm
2LE adjustable metal swivelling lever with stainless steel rod Ø3x125 mm
2LH adjustable metal swivelling lever with fiber glass rod Ø6x200 mm
2LL metal swivelling lever with adjustable flexible rod
2LP ⊖ metal swivelling lever with porcelain roll
200 ⊖ metal head for swivelling lever actuators

LOOSE ACTUATORS
See page 139

Code structure

Attention! The feasibility of a code number does not mean the effective availability of a product. Please contact our sales office.

article options
NF B110AB-DN2 GR7T6W5

Housing NF technopolymer, hole spacing 20 mm					Transmission block without transmission block W5 90° transmission block
Contact blocks B11 1NO+1NC, snap action B02 2NC, snap action B12 1NO+2NC, snap action B22 2NO+2NC, snap action G11 1NO+1NC, slow action G02 2NC, slow action G12 1NO+2NC, slow action G22 2NO+2NC, slow action H11 1NO+1NC, slow action, overlapped H12 1NO+2NC, slow action, overlapped H22 2NO+2NC, slow action, overlapped L11 1NO+1NC, slow action closer L12 1NO+2NC, slow action closer L22 2NO+2NC, slow action closer					Ambient temperature -25°C ... +80°C (standard) T6 -40°C ... +80°C
Other contact blocks on request.					Rollers standard roller R30 stainless steel Ø 10.6 mm R29 stainless steel, Ø 13 mm R18 technopolymer, Ø 14 mm R23 stainless steel, Ø 14 mm R7 technopolymer, Ø 18 mm R22 technopolymer, Ø 20 mm R24 stainless steel, Ø 20 mm R19 technopolymer, Ø 22 mm R25 technopolymer, Ø 35 mm
Actuator heads 0 without head 2 head for swivelling lever actuators					Contact type silver contacts (standard) G silver contacts with 1 µm gold coating
Actuators AA short plunger AB plunger ...					Connection type 2 cable, length 2 m (standard) 5 cable, length 5 m K connector Other cable lengths on request.
Output direction D cable or connector to the right S connector at bottom					Cable or connector type N black PVC cable, IEC 60332-1 (standard) G grey PVC cable, CEI 20-22 II M M12 connector A AMP superseal 1.5 connector

Check feasibility using table on page 132.



Main features

- Technopolymer housing, right or bottom cable output
- Protection degrees IP67 and IP69K
- 2 types of integrated cable available
- Versions with M12 connector for safety applications ☹
- Versions with AMP connector
- 14 contact blocks available
- 37 actuators available

Markings and quality marks:



IMQ approval:	CA02.04562
UL approval:	E131787
CCC approval:	2013010305653520
EAC approval:	RU C-IT DM94.B.01024

Technical data

Housing

Housing made of fiber glass reinforced technopolymer, self-extinguishing, shock-proof and with double insulation ☹.

Version with integrated cable, standard length 2 m. Other lengths and special cables on request.

Versions with integrated M12 connector, 4 or 8 poles

Protection degree:

IP67 according to EN 60529

IP69K according to ISO 20653

(Protect the cables from direct high-pressure and high-temperature jets)

Corrosion resistance in saline mist:

≥ 300 hours in NSS according to ISO 9227

General data

Ambient temperature:

See table on page 132

Max actuation frequency:

3600 operating cycles¹/hour

Mechanical endurance:

20 million operating cycles¹

Mounting position:

any

Safety parameters:

B_{10d}:

40,000,00 for NC contacts

Mechanical interlock, not coded:

type 1 according to EN ISO 14119

Tightening torques for installation:

see pages 235-246

(1) One operation cycle means two movements, one to close and one to open contacts, as defined in EN 60947-5-1.

Electrical data

Rated impulse withstand voltage (U_{imp}):

4 kV

Conditional short circuit current:

1000 A according to EN 60947-5-1

Pollution degree:

3

In conformity with standards:

IEC 60947-5-1, EN 60947-5-1, IEC 60204-1, EN 60204-1, EN ISO 14119, EN ISO 12100, EN 60529, ISO 20653, UL 508, CSA 22.2 No.14.

In conformity with the requirements of:

Low Voltage Directive 2006/95/EC, Machinery Directive 2006/42/EC and EMC Directive 2004/108/EC.

Positive contact opening in conformity with standards:

IEC 60947-5-1, EN 60947-5-1.

⚠ Installation for safety applications:

Use only switches marked with the symbol ☹ aside the product code. Always connect the safety circuit to the **NC contacts** (normally closed contacts: see "internal connections" on page 132) as stated in **EN 60947-5-1, encl. K, par. 2**. Actuate the switch **at least up to the positive opening travel** shown in the travel diagrams on page 244. Operate the switch **at least with the positive opening force**, indicated between brackets below each article, aside the minimum force value. All applicable standards must be respected.

⚠ **If not expressly indicated in this chapter, for correct installation and utilization of all articles see chapter utilization requirements from page 235 to page 246.**

⚠ **Important: Switch off the circuit voltage before disconnecting the connector from the switch. The connector is not suitable for separation of electrical loads.**

Characteristics approved by IMQ

Rated insulation voltage (Ui):	250 Vac
Conventional free air thermal current (I _{th}):	10 A (1-2 contacts) / 6 A (2-3 contacts) / 4 A (4 contacts or 4-pin M12 connector)
Protection against short circuits (fuse):	10 A (1-2 contacts) / 6 A (2-3 contacts) / 4 A (4 contacts or 4-pin M12 connector), gG type
Rated impulse withstand voltage (U _{imp}):	4 kV
Protection degree of the housing:	IP67
MA terminals (saddle clamps)	
Pollution degree:	3
Utilization category:	AC15 / DC13 (with connector)
Operating voltage (U _e):	250 Vac (50 Hz) / 24 Vdc (with connector)
Operating current (I _e):	3 A / 2 A (with connector)
Forms of the contact element:	X, Y, X+Y, X+X, Y+Y, Y+Y+X, X+X+Y, X+X+Y+Y, Zb
Positive opening of contacts on contact blocks	B01, B11, B02, B12, B21, B22, G01, G11, G02, G12, G21, G22, L01, L11, L02, L12, L21, L22, H01, H11, H02, H12, H21, H22
In conformity with standards:	EN 60947-1, EN 60947-5-1 + A1:2009, fundamental requirements of the Low Voltage Directive 2006/95/EC.

Please contact our technical service for the list of approved products.

Characteristics approved by UL

Utilization categories	R300 pilot duty (28 VA, 125-250 Vdc) B300 pilot duty (360 VA, 120-240 Vac) (1-2-3 cont.) C300 pilot duty (180 VA, 120-240 Vac) (4 cont.)
Data of housing type 1, 4X "indoor use only"; 12.	
Housing data for versions with 1-2 contacts and type N cable type 1, 4X "indoor use only"	
In conformity with standard:	UL 508, CSA 22.2 No.14

Please contact our technical service for the list of approved products.



Utilization temperatures and electrical data

	Output with cable				Output with M12 connector		Output with AMP connector
	Versions with 2 contacts		Versions with 3 contacts	Versions with 4 contacts	Versions with 2 contacts	Versions with 3/4 contacts	Versions with 2 contacts
	Cable type N 5x0.75 mm ² ,	Cable type G 5x0.75 mm ² ,	Cable type N 7x0.5 mm ²	Cable type N 9x0.34 mm ²	M12 connector 5 poles	M12 connector 8 poles	AMP superseal 1.5 connector
Sheath PVC 05VV-F, Self-extinguishing: IEC 60332-1-2 IEC 60332-1-3	Sheath PVC S05VV-F, Self-extinguishing: IEC 60332-1-2 IEC 60332-1-3 IEC 60332-3 CEI 20-22 II	Sheath PVC 03VV-F, Self-extinguishing IEC 60332-1-2 IEC 60332-1-3	Sheath PVC 03VV-F, Self-extinguishing: IEC 60332-1-2 IEC 60332-1-3				
Minimum bending radius: 72 mm	Minimum bending radius: 72 mm	Minimum bending radius: 108 mm	Minimum bending radius: 94 mm				
External diameter: 8 mm	External diameter: 8 mm	External diameter: 7 mm	External diameter: 7 mm				
Stripped end: 80 mm	Stripped end: 80 mm	Stripped end: 80 mm	Stripped end: 80 mm				
Class 5 copper IEC 60228	Class 5 copper IEC 60228	Class 5 copper IEC 60228	Class 5 copper IEC 60228				

Ambient temperature standard extended (-T6)	Cable fixed installation	-25 °C ... +70 °C	-25 °C ... +70 °C	-25°C ... +80°C	-25°C ... +80°C				
	Cable flexible installation	+5 °C ... +70 °C	+5 °C ... +70 °C	-5 °C ... +80 °C	-5 °C ... +80 °C			-25°C ... +80°C	
	Cable mobile installation	/	/	/	/				
	Cable fixed installation	/	/	/	/				
	Cable flexible installation	/	/	/	/			-40°C ... +80°C	
	Cable mobile installation	/	/	/	/				
Electrical data	Thermal current I _{th}	10 A	10 A	6 A	3 A	4 A	2 A	10 A	
	Rated insulation voltage U _i	250 Vac	250 Vac	250 Vac	250 Vac	250 Vac 300 Vdc	30 Vac 36 Vdc	250 Vac 300 Vdc	
	Protection against short circuits (fuse)	10 A 500 V type gG	10 A 500 V type gG	6 A 500 V type gG	3 A 500 V type gG	4 A 500 V type gG	2 A 500 V type gG	10 A 500 V type gG	
	Utilization category DC13	24 V	2 A	2 A	2 A	2 A	2 A	2 A	2 A
		125 V	0.4 A	0.4 A	0.4 A	0.4 A	0.4 A	/	0.4 A
		250 V	0.3 A	0.3 A	0.3 A	0.3 A	0.3 A	/	0.3 A
Utilization category AC15	24 V	4 A	4 A	4 A	3 A	4 A	2 A	4 A	
	120 V	4 A	4 A	4 A	3 A	4 A	/	4 A	
	250 V	4 A	4 A	4 A	3 A	4 A	/	4 A	
Approvals	CE cULus IMQ EAC CCC	CE EAC CCC	CE cULus IMQ EAC CCC	CE cULus IMQ EAC CCC	CE cULus IMQ EAC CCC	CE cULus IMQ EAC CCC	CE cULus EAC CCC	CE cULus EAC CCC	

Internal connections of the cable

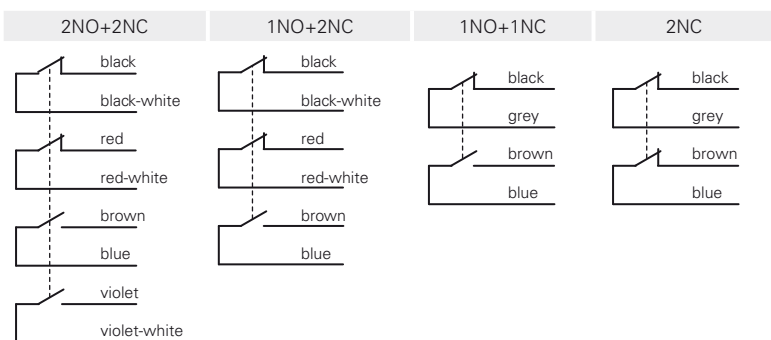

Internal connections of the connector

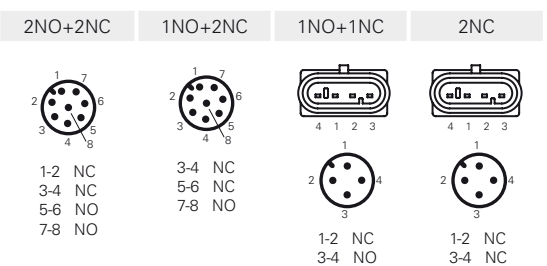

Female connectors See page 226

Contact type:

- R = snap action
- L = slow action

Contact blocks

				With external rubber gasket
B11	R NF B110AA-DN2 ⊕ 1NO+1NC	NF B110AB-DN2 ⊖ 1NO+1NC	NF B110AC-DN2 ⊕ 1NO+1NC	NF B110AE-DN2 ⊕ 1NO+1NC
B02	R NF B020AA-DN2 ⊕ 2NC	NF B020AB-DN2 ⊖ 2NC	NF B020AC-DN2 ⊕ 2NC	NF B020AE-DN2 ⊕ 2NC
B12	R NF B120AA-DN2 ⊕ 1NO+2NC	NF B120AB-DN2 ⊖ 1NO+2NC	NF B120AC-DN2 ⊕ 1NO+2NC	NF B120AE-DN2 ⊕ 1NO+2NC
B22	R NF B220AA-DN2 ⊕ 2NO+2NC	NF B220AB-DN2 ⊖ 2NO+2NC	NF B220AC-DN2 ⊕ 2NO+2NC	NF B220AE-DN2 ⊕ 2NO+2NC
G11	L NF G110AA-DN2 ⊕ 1NO+1NC	NF G110AB-DN2 ⊖ 1NO+1NC	NF G110AC-DN2 ⊕ 1NO+1NC	NF G110AE-DN2 ⊕ 1NO+1NC
G02	L NF G020AA-DN2 ⊕ 2NC	NF G020AB-DN2 ⊖ 2NC	NF G020AC-DN2 ⊕ 2NC	NF G020AE-DN2 ⊕ 2NC
G12	L NF G120AA-DN2 ⊕ 1NO+2NC	NF G120AB-DN2 ⊖ 1NO+2NC	NF G120AC-DN2 ⊕ 1NO+2NC	NF G120AE-DN2 ⊕ 1NO+2NC
G22	L NF G220AA-DN2 ⊕ 2NO+2NC	NF G220AB-DN2 ⊖ 2NO+2NC	NF G220AC-DN2 ⊕ 2NO+2NC	NF G220AE-DN2 ⊕ 2NO+2NC
Max. speed	page 243 - type 4	page 243 - type 4	page 243 - type 4	page 243 - type 4
Min. force	7 N (25 N ⊕)	7 N (25 N ⊕)	7 N (25 N ⊕)	7 N (25 N ⊕)
Travel diagrams	page 244 - group 1	page 244 - group 1	page 244 - group 1	page 244 - group 1

Contact blocks

		With external rubber gasket	With external rubber gasket	With stainless steel roller on request
B11	R NF B110BB-DN2 ⊕ 1NO+1NC	NF B110BE-DN2 ⊖ 1NO+1NC	NF B110BG-DN2 ⊕ 1NO+1NC	NF B110CB-DN2 ⊕ 1NO+1NC
B02	R NF B020BB-DN2 ⊕ 2NC	NF B020BE-DN2 ⊖ 2NC	NF B020BG-DN2 ⊕ 2NC	NF B020CB-DN2 ⊕ 2NC
B12	R NF B120BB-DN2 ⊕ 1NO+2NC	NF B120BE-DN2 ⊖ 1NO+2NC	NF B120BG-DN2 ⊕ 1NO+2NC	NF B120CB-DN2 ⊕ 1NO+2NC
B22	R NF B220BB-DN2 ⊕ 2NO+2NC	NF B220BE-DN2 ⊖ 2NO+2NC	NF B220BG-DN2 ⊕ 2NO+2NC	NF B220CB-DN2 ⊕ 2NO+2NC
G11	L NF G110BB-DN2 ⊕ 1NO+1NC	NF G110BE-DN2 ⊖ 1NO+1NC	NF G110BG-DN2 ⊕ 1NO+1NC	NF G110CB-DN2 ⊕ 1NO+1NC
G02	L NF G020BB-DN2 ⊕ 2NC	NF G020BE-DN2 ⊖ 2NC	NF G020BG-DN2 ⊕ 2NC	NF G020CB-DN2 ⊕ 2NC
G12	L NF G120BB-DN2 ⊕ 1NO+2NC	NF G120BE-DN2 ⊖ 1NO+2NC	NF G120BG-DN2 ⊕ 1NO+2NC	NF G120CB-DN2 ⊕ 1NO+2NC
G22	L NF G220BB-DN2 ⊕ 2NO+2NC	NF G220BE-DN2 ⊖ 2NO+2NC	NF G220BG-DN2 ⊕ 2NO+2NC	NF G220CB-DN2 ⊕ 2NO+2NC
Max. speed	page 243 - type 2	page 243 - type 5	page 243 - type 5	page 243 - type 3
Min. force	7 N (25 N ⊕)	7 N (25 N ⊕)	7 N (25 N ⊕)	5 N (25 N ⊕)
Travel diagrams	page 244 - group 1	page 244 - group 1	page 244 - group 1	page 244 - group 2

M12 connector, right

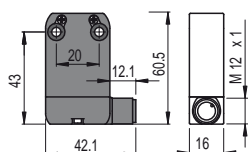

M12 connector, bottom

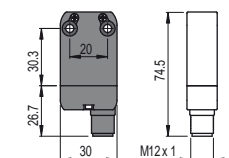

AMP superseal 1.5 connector

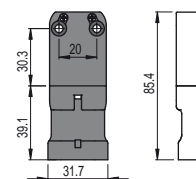

To purchase a product with M12 connector from the right replace DN2 with DMK in the codes shown above. Example:
NF B110AA-DN2 → NF B110AA-DMK

To purchase a product with M12 connector from below replace DN2 with SMK in the codes shown above. Example:
NF B110AA-DN2 → NF B110AA-SMK

To purchase a product with AMP connector replace DN2 with SAK in the codes shown above. Example:
NF B110AA-DN2 → NF B110AA-SAK

All measures in the drawings are in mm

Items with code on green background are stock items

Accessories See page 225

→ The 2D/3D files are available at www.pizzato.com



Contact type: R = snap action L = slow action	With stainless steel roller on request	Operation in one direction	Fixed only by threaded head	
		It does not switch It switches		
Contact blocks				
B11 R	NF B110CH-DN2	NF B110CP-DN2	NF B110CV-DN2	NF B110EB-DN2
B02 R	NF B020CH-DN2	NF B020CP-DN2	NF B020CV-DN2	NF B020EB-DN2
B12 R	NF B120CH-DN2	NF B120CP-DN2	NF B120CV-DN2	NF B120EB-DN2
B22 R	NF B220CH-DN2	NF B220CP-DN2	NF B220CV-DN2	NF B220EB-DN2
G11 L	NF G110CH-DN2	NF G110CP-DN2	NF G110CV-DN2	NF G110EB-DN2
G02 L	NF G020CH-DN2	NF G020CP-DN2	NF G020CV-DN2	NF G020EB-DN2
G12 L	NF G120CH-DN2	NF G120CP-DN2	NF G120CV-DN2	NF G120EB-DN2
G22 L	NF G220CH-DN2	NF G220CP-DN2	NF G220CV-DN2	NF G220EB-DN2
Max. speed	page 243 - type 3	page 243 - type 3	page 243 - type 3	page 243 - type 4
Min. force	5 N (25 N	3 N (25 N	3 N (25 N	7 N (25 N
Travel diagrams	page 244 - group 2	page 244 - group 6	page 244 - group 3	page 244 - group 1

Contact blocks	Fixed only by threaded head With external rubber gasket	Fixed only by threaded head	Plunger with Ø 6 mm ball	With external rubber gasket
B11 R	NF B110EE-DN2	NF B110FB-DN2	NF B110GB-DN2	NF B110HB-DN2
B02 R	NF B020EE-DN2	NF B020FB-DN2	NF B020GB-DN2	NF B020HB-DN2
B12 R	NF B120EE-DN2	NF B120FB-DN2	NF B120GB-DN2	NF B120HB-DN2
B22 R	NF B220EE-DN2	NF B220FB-DN2	NF B220GB-DN2	NF B220HB-DN2
G11 L	NF G110EE-DN2	NF G110FB-DN2	NF G110GB-DN2	
G02 L	NF G020EE-DN2	NF G020FB-DN2	NF G020GB-DN2	NF G020HB-DN2
G12 L	NF G120EE-DN2	NF G120FB-DN2	NF G120GB-DN2	
G22 L	NF G220EE-DN2	NF G220FB-DN2	NF G220GB-DN2	
Max. speed	page 243 - type 4	page 243 - type 2	page 243 - type 2	1 m/s
Min. force	7 N (25 N	7 N (25 N	7 N (25 N	0.03 Nm
Travel diagrams	page 244 - group 1	page 244 - group 1	page 244 - group 1	page 244 - group 4

All measures in the drawings are in mm

Contact type:

R = snap action
L = slow action

	With external rubber gasket		With external rubber gasket		With stainless steel roller on request		With stainless steel roller on request	
Contact blocks								
B11	R	NF B110HE-DN2 1NO+1NC	NF B110HH-DN2 1NO+1NC	NF B112KA-DN2 \rightarrow 1NO+1NC	NF B112KB-DN2 \rightarrow 1NO+1NC			
B02	R	NF B020HE-DN2 2NC	NF B020HH-DN2 2NC	NF B022KA-DN2 \rightarrow 2NC	NF B022KB-DN2 \rightarrow 2NC			
B12	R	NF B120HE-DN2 1NO+2NC	NF B120HH-DN2 1NO+2NC	NF B122KA-DN2 \rightarrow 1NO+2NC	NF B122KB-DN2 \rightarrow 1NO+2NC			
B22	R	NF B220HE-DN2 2NO+2NC	NF B220HH-DN2 2NO+2NC	NF B222KA-DN2 \rightarrow 2NO+2NC	NF B222KB-DN2 \rightarrow 2NO+2NC			
G11	L			NF G112KA-DN2 \rightarrow 1NO+1NC	NF G112KB-DN2 \rightarrow 1NO+1NC			
G02	L	NF G020HE-DN2 2NC	NF G020HH-DN2 2NC	NF G022KA-DN2 \rightarrow 2NC	NF G022KB-DN2 \rightarrow 2NC			
G12	L			NF G122KA-DN2 \rightarrow 1NO+2NC	NF G122KB-DN2 \rightarrow 1NO+2NC			
G22	L			NF G222KA-DN2 \rightarrow 2NO+2NC	NF G222KB-DN2 \rightarrow 2NO+2NC			
Max. speed	1 m/s		1 m/s		page 243 - type 1		page 243 - type 1	
Min. force	0.07 Nm		0.03 Nm		0.07 Nm (0.25 Nm \rightarrow)		0.07 Nm (0.25 Nm \rightarrow)	
Travel diagrams	page 244 - group 4		page 244 - group 4		page 244 - group 5		page 244 - group 5	

	With stainless steel roller on request		With stainless steel roller on request		With stainless steel roller on request		With stainless steel roller on request	
Contact blocks								
B11	R	NF B112KC-DN2 \rightarrow 1NO+1NC	NF B112KD-DN2 \rightarrow 1NO+1NC	NF B112KE-DN2 \rightarrow 1NO+1NC	NF B112KF-DN2 \rightarrow 1NO+1NC			
B02	R	NF B022KC-DN2 \rightarrow 2NC	NF B022KD-DN2 \rightarrow 2NC	NF B022KE-DN2 \rightarrow 2NC	NF B022KF-DN2 \rightarrow 2NC			
B12	R	NF B122KC-DN2 \rightarrow 1NO+2NC	NF B122KD-DN2 \rightarrow 1NO+2NC	NF B122KE-DN2 \rightarrow 1NO+2NC	NF B122KF-DN2 \rightarrow 1NO+2NC			
B22	R	NF B222KC-DN2 \rightarrow 2NO+2NC	NF B222KD-DN2 \rightarrow 2NO+2NC	NF B222KE-DN2 \rightarrow 2NO+2NC	NF B222KF-DN2 \rightarrow 2NO+2NC			
G11	L	NF G112KC-DN2 \rightarrow 1NO+1NC	NF G112KD-DN2 \rightarrow 1NO+1NC	NF G112KE-DN2 \rightarrow 1NO+1NC	NF G112KF-DN2 \rightarrow 1NO+1NC			
G02	L	NF G022KC-DN2 \rightarrow 2NC	NF G022KD-DN2 \rightarrow 2NC	NF G022KE-DN2 \rightarrow 2NC	NF G022KF-DN2 \rightarrow 2NC			
G12	L	NF G122KC-DN2 \rightarrow 1NO+2NC	NF G122KD-DN2 \rightarrow 1NO+2NC	NF G122KE-DN2 \rightarrow 1NO+2NC	NF G122KF-DN2 \rightarrow 1NO+2NC			
G22	L	NF G222KC-DN2 \rightarrow 2NO+2NC	NF G222KD-DN2 \rightarrow 2NO+2NC	NF G222KE-DN2 \rightarrow 2NO+2NC	NF G222KF-DN2 \rightarrow 2NO+2NC			
Max. speed	page 243 - type 1		page 243 - type 1		page 243 - type 1		page 243 - type 1	
Min. force	0.07 Nm (0.25 Nm \rightarrow)		0.07 Nm (0.25 Nm \rightarrow)		0.07 Nm (0.25 Nm \rightarrow)		0.07 Nm (0.25 Nm \rightarrow)	
Travel diagrams	page 244 - group 5		page 244 - group 5		page 244 - group 5		page 244 - group 5	

M12 connector, right

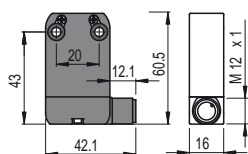

M12 connector, bottom

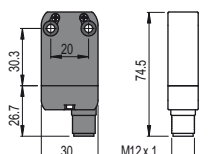

AMP superseal 1.5 connector

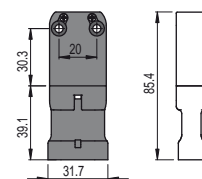

To purchase a product with M12 connector from the right replace DN2 with DMK in the codes shown above. Example:
NF B110AA-DN2 \rightarrow NF B110AA-DMK

To purchase a product with M12 connector from below replace DN2 with SMK in the codes shown above. Example:
NF B110AA-DN2 \rightarrow NF B110AA-SMK

To purchase a product with AMP connector replace DN2 with SAK in the codes shown above. Example:
NF B110AA-DN2 \rightarrow NF B110AA-SAK

All measures in the drawings are in mm



	With stainless steel roller on request	With stainless steel roller on request	With stainless steel roller on request	Square rod, 3x3 mm, stainless steel
Contact type:	<p>R = snap action L = slow action</p>			
Contact blocks				
B11	R NF B112KG-DN2 → 1NO+1NC	R NF B112KH-DN2 → 1NO+1NC	R NF B112KP-DN2 → 1NO+1NC	R NF B112LB-DN2 → 1NO+1NC
B02	R NF B022KG-DN2 → 2NC	R NF B022KH-DN2 → 2NC	R NF B022KP-DN2 → 2NC	R NF B022LB-DN2 → 2NC
B12	R NF B122KG-DN2 → 1NO+2NC	R NF B122KH-DN2 → 1NO+2NC	R NF B122KP-DN2 → 1NO+2NC	R NF B122LB-DN2 → 1NO+2NC
B22	R NF B222KG-DN2 → 2NO+2NC	R NF B222KH-DN2 → 2NO+2NC	R NF B222KP-DN2 → 2NO+2NC	R NF B222LB-DN2 → 2NO+2NC
G11	L NF G112KG-DN2 → 1NO+1NC	L NF G112KH-DN2 → 1NO+1NC	L NF G112KP-DN2 → 1NO+1NC	L NF G112LB-DN2 → 1NO+1NC
G02	L NF G022KG-DN2 → 2NC	L NF G022KH-DN2 → 2NC	L NF G022KP-DN2 → 2NC	L NF G022LB-DN2 → 2NC
G12	L NF G122KG-DN2 → 1NO+2NC	L NF G122KH-DN2 → 1NO+2NC	L NF G122KP-DN2 → 1NO+2NC	L NF G122LB-DN2 → 1NO+2NC
G22	L NF G222KG-DN2 → 2NO+2NC	L NF G222KH-DN2 → 2NO+2NC	L NF G222KP-DN2 → 2NO+2NC	L NF G222LB-DN2 → 2NO+2NC
Max. speed	page 243 - type 1	page 243 - type 1	page 243 - type 1	1.5 m/s
Min. force	0.07 Nm (0.25 Nm →)	0.07 Nm (0.25 Nm →)	0.07 Nm (0.25 Nm →)	0.07 Nm
Travel diagrams	page 244 - group 5	page 244 - group 5	page 244 - group 5	page 244 - group 5

	Round rod, Ø 3 mm, stainless steel	Fiber glass rod		Porcelain roller
Contact blocks				
B11	R NF B112LE-DN2 → 1NO+1NC	R NF B112LH-DN2 → 1NO+1NC	R NF B112LL-DN2 → 1NO+1NC	R NF B112LP-DN2E24 → 1NO+1NC
B02	R NF B022LE-DN2 → 2NC	R NF B022LH-DN2 → 2NC	R NF B022LL-DN2 → 2NC	R NF B022LP-DN2E24 → 2NC
B12	R NF B122LE-DN2 → 1NO+2NC	R NF B122LH-DN2 → 1NO+2NC	R NF B122LL-DN2 → 1NO+2NC	R NF B122LP-DN2E24 → 1NO+2NC
B22	R NF B222LE-DN2 → 2NO+2NC	R NF B222LH-DN2 → 2NO+2NC	R NF B222LL-DN2 → 2NO+2NC	R NF B222LP-DN2E24 → 2NO+2NC
G11	L NF G112LE-DN2 → 1NO+1NC	L NF G112LH-DN2 → 1NO+1NC	L NF G112LL-DN2 → 1NO+1NC	L NF G112LP-DN2E24 → 1NO+1NC
G02	L NF G022LE-DN2 → 2NC	L NF G022LH-DN2 → 2NC	L NF G022LL-DN2 → 2NC	L NF G022LP-DN2E24 → 2NC
G12	L NF G122LE-DN2 → 1NO+2NC	L NF G122LH-DN2 → 1NO+2NC	L NF G122LL-DN2 → 1NO+2NC	L NF G122LP-DN2E24 → 1NO+2NC
G22	L NF G222LE-DN2 → 2NO+2NC	L NF G222LH-DN2 → 2NO+2NC	L NF G222LL-DN2 → 2NO+2NC	L NF G222LP-DN2E24 → 2NO+2NC
Max. speed	1.5 m/s	1.5 m/s	1.5 m/s	0.5 m/s
Min. force	0.07 Nm	0.07 Nm	0.07 Nm	0.04 Nm
Travel diagrams	page 244 - group 5	page 244 - group 5	page 244 - group 5	page 244 - group 5

All measures in the drawings are in mm

Contact type:

- R** = snap action
- L** = slow action

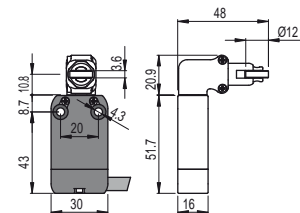
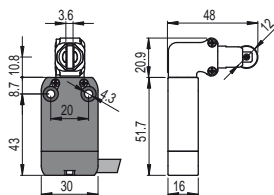
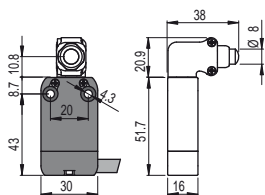

Contact blocks

B11	R	NF B110AB-DN2W5	⊕ 1NO+1NC	NF B110BB-DN2H0W5	⊕ 1NO+1NC	NF B110BB-DN2W5	⊕ 1NO+1NC
B02	R	NF B020AB-DN2W5	⊕ 2NC	NF B020BB-DN2H0W5	⊕ 2NC	NF B020BB-DN2W5	⊕ 2NC
B12	R	NF B120AB-DN2W5	⊕ 1NO+2NC	NF B120BB-DN2H0W5	⊕ 1NO+2NC	NF B120BB-DN2W5	⊕ 1NO+2NC
B22	R	NF B220AB-DN2W5	⊕ 2NO+2NC	NF B220BB-DN2H0W5	⊕ 2NO+2NC	NF B220BB-DN2W5	⊕ 2NO+2NC
G11	L	NF G110AB-DN2W5	⊕ 1NO+1NC	NF G110BB-DN2H0W5	⊕ 1NO+1NC	NF G110BB-DN2W5	⊕ 1NO+1NC
G02	L	NF G020AB-DN2W5	⊕ 2NC	NF G020BB-DN2H0W5	⊕ 2NC	NF G020BB-DN2W5	⊕ 2NC
G12	L	NF G120AB-DN2W5	⊕ 1NO+2NC	NF G120BB-DN2H0W5	⊕ 1NO+2NC	NF G120BB-DN2W5	⊕ 1NO+2NC
G22	L	NF G220AB-DN2W5	⊕ 2NO+2NC	NF G220BB-DN2H0W5	⊕ 2NO+2NC	NF G220BB-DN2W5	⊕ 2NO+2NC
Max. speed		page 243 - type 4		page 243 - type 2		page 243 - type 2	
Min. force		9.5 N (25 N ⊕)		9.5 N (25 N ⊕)		9.5 N (25 N ⊕)	
Travel diagrams		page 244 - group 1		page 244 - group 1		page 244 - group 1	

With external gasket

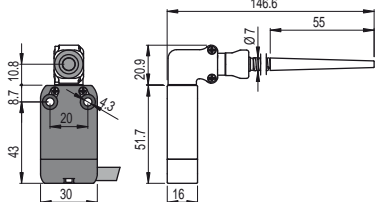

With external gasket

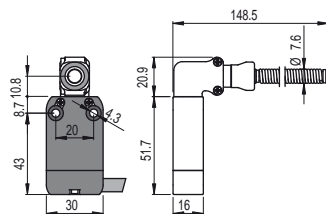

With external gasket

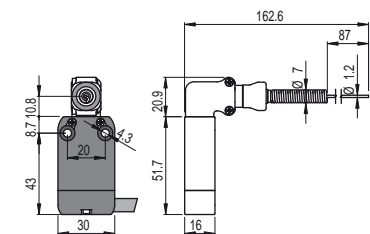

Contact blocks

B11	R	NF B110HB-DN2W5	1NO+1NC	NF B110HE-DN2W5	1NO+1NC	NF B110HH-DN2W5	1NO+1NC
B02	R	NF B020HB-DN2W5	2NC	NF B020HE-DN2W5	2NC	NF B020HH-DN2W5	2NC
B12	R	NF B120HB-DN2W5	1NO+2NC	NF B120HE-DN2W5	1NO+2NC	NF B120HH-DN2W5	1NO+2NC
B22	R	NF B220HB-DN2W5	2NO+2NC	NF B220HE-DN2W5	2NO+2NC	NF B220HH-DN2W5	2NO+2NC
G11	L						
G02	L	NF G020HB-DN2W5	2NC	NF G020HE-DN2W5	2NC	NF G020HH-DN2W5	2NC
G12	L						
G22	L						
Max. speed		1 m/s		1 m/s		1 m/s	
Min. force		0.08 Nm		0.12 Nm		0.08 Nm	
Travel diagrams		page 244 - group 4		page 244 - group 4		page 244 - group 4	

M12 connector, right

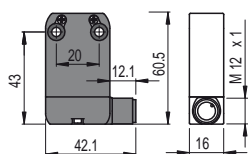

M12 connector, bottom

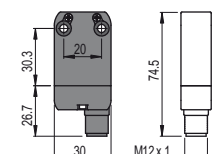

AMP superseal 1.5 connector

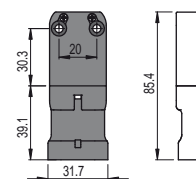

To purchase a product with M12 connector from the right replace DN2 with DMK in the codes shown above. Example:
NF B110AA-DN2 → NF B110AA-DMK

To purchase a product with M12 connector from below replace DN2 with SMK in the codes shown above. Example:
NF B110AA-DN2 → NF B110AA-SMK

To purchase a product with AMP connector replace DN2 with SAK in the codes shown above. Example:
NF B110AA-DN2 → NF B110AA-SAK

All measures in the drawings are in mm

Accessories

Article	Description
VN DT1F	Spacer for NA-NF series
VF D16B	Spacer for NB series

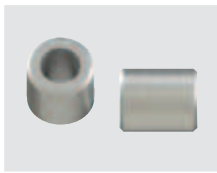

By interposing the spacers between one switch and the next, it is possible to have 2 or more prewired switches, preventing them from moving in relation to one another.
10 pcs. packs

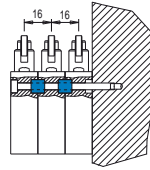

M12 connectors with cable

for details see page 225



Technical data:

- Polyurethane connector body (4/5/8 poles)
- Polypropylene connector body (12 poles)
- Class 6 rated copper of the wires according to IEC 60228 for mobile installation (4/5/8 poles)
- Class 5 rated copper of the wires according to IEC 60228 for fixed installation (12 poles)
- Gold-plated contacts (resistance < 5 mΩ)
- Self locking ring nut
- High flexibility wire suitable to be used in movable chains, with PVC sheath conforming to IEC 60332-3 and CEI 20-22II standards. With polyurethane sheath on request (4/5/8 poles)
- PVC cable, fixed installation (12 poles)

Code structure

Attention! The feasibility of a code number does not mean the effective availability of a product. Please contact our sales office.

VF CA4PD3M

No. of poles	
4	4 poles
5	5 poles
8	8 poles
12	12 poles

Sheath coating	
P	PVC (standard)
U	PUR

Connector type	
D	straight (standard)
G	angled

Connection type		No. of poles			
M	M12x1				
Cable length (L)		4	5	8	12
1	1 metre				
2	2 metres				
3	3 metres (standard)	•	•		
4	4 metres				
5	5 metres (standard)	•	•	•	•
...					
0	10 metres (standard)	•	•	•	•

Other lengths on request

Stock items

- VF CA4PD3M
- VF CA4PD5M
- VF CA4PD0M
- VF CA5PD3M
- VF CA5PD5M
- VF CA5PD0M
- VF CA8PD5M
- VF CA8PD0M
- VF CA12PD5M
- VF CA12PD0M

Attention! No stock item, minimum order quantity 100 pcs.

M12 sockets, field wireable



General data

Technopolymer connector body
Gold-plated contacts
Screw terminals for wiring
Max. operating voltages: 250 Vac/dc (4 and 5 poles)
30 Vac/dc (8 poles)
Maximum current: 4 A
Protection degree: IP67 according to EN 60529
Ambient temperature: -25°C ... +85°C
Wire cross-section: from 0.25 mm² (24 AWG) to 0.5 mm² (20 AWG)

Article	Description	no. of poles
VF CBMP4DM04	Field wireable M12 socket, straight, for multipolar cables from Ø 4 to Ø 6.5 mm	4
VF CBMP5DM04	Field wireable M12 socket, straight, for multipolar cables from Ø 4 to Ø 6.5 mm	5
VF CBMP8DM04	Field wireable M12 socket, straight, for multipolar cables from Ø 4 to Ø 7 mm	8

Items with code on **green** background are stock items

→ The 2D/3D files are available at www.pizzato.com

Selection diagram for NA - NB - NF series components sold separately

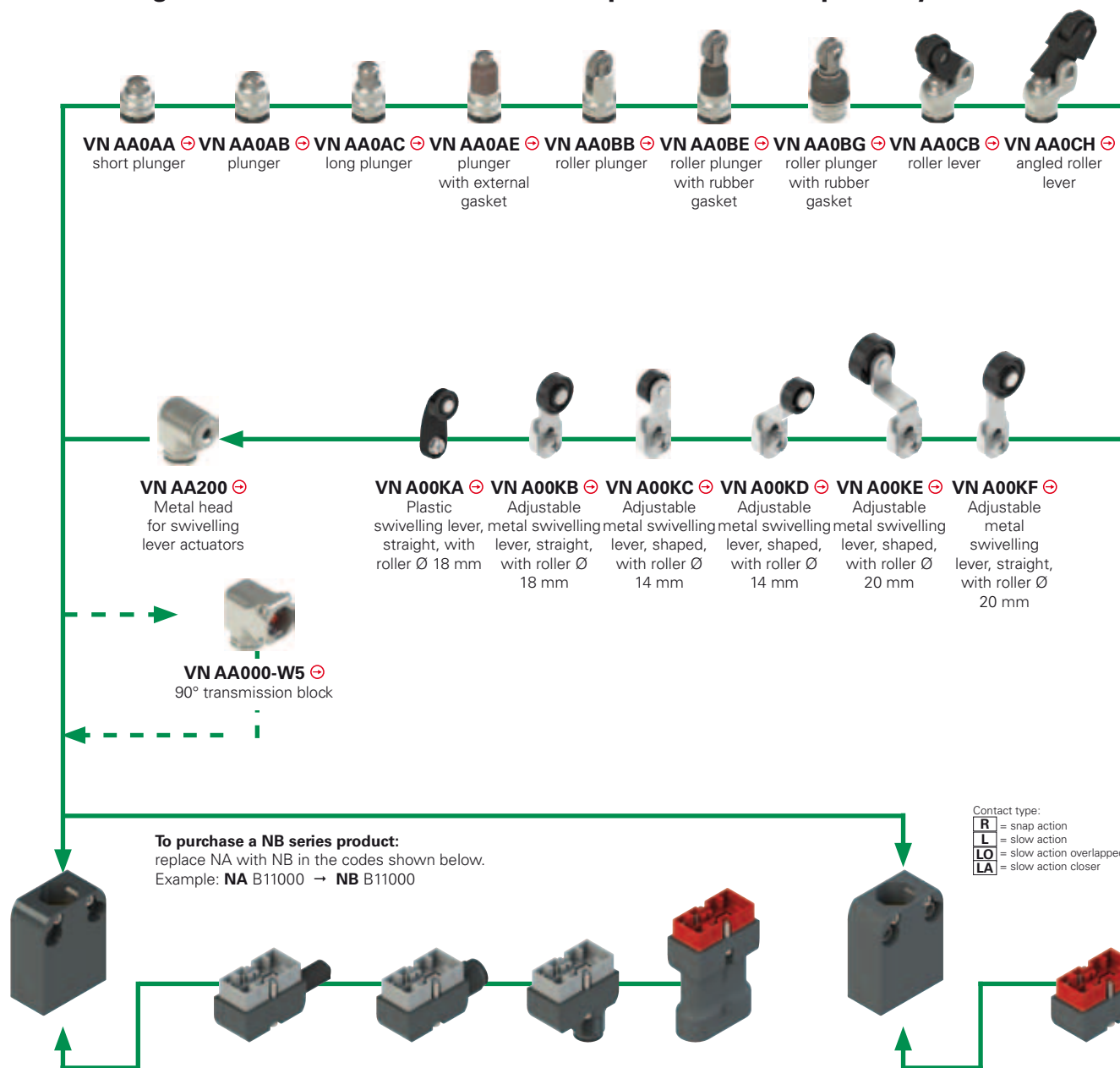

NA METAL housing hole spacing 20 mm		
NA B11000 ⊕ 1NO+1NC R		
NA G11000 ⊕ 1NO+1NC L		
NA L11000 ⊕ 1NO+1NC LA		
NA H11000 ⊕ 1NO+1NC LO		
NA B02000 ⊕ 2NC R		
NA G02000 ⊕ 2NC L		
NA B20000 ⊕ 2NO R		
NA G20000 ⊕ 2NO L		
NA B12000 ⊕ 1NO+2NC R		
NA G12000 ⊕ 1NO+2NC L		
NA L12000 ⊕ 1NO+2NC LA		
NA H12000 ⊕ 1NO+2NC LO		
NA B22000 ⊕ 2NO+2NC R		
NA G22000 ⊕ 2NO+2NC L		
NA L22000 ⊕ 2NO+2NC LA		
NA H22000 ⊕ 2NO+2NC LO		

Metal connector with cable	cable length (m)
VN CM11DN2	2
VN CM11DN5	5
VN CM02DN2	2
VN CM02DN5	5
/	/
/	/
VN CM12DN2	2
VN CM12DN5	5
VN CM22DN2	2
VN CM22DN5	5

M12 metal connector, right	M12 metal connector, bottom
VN CM11DMK	VN CM11SMK
VN CM02DMK	VN CM02SMK
VN CM20DMK	VN CM20SMK
VN CM12DMK	VN CM12SMK
VN CM22DMK	VN CM22SMK

AMP technopolymer connector, bottom
VN CM11SAK
VN CM02SAK
VN CM20SAK

NF TECHNOPOLYMER housing, 20 mm hole spacing
NF B11000 ⊕ 1NO+1NC R
NF G11000 ⊕ 1NO+1NC L
NF L11000 ⊕ 1NO+1NC LA
NF H11000 ⊕ 1NO+1NC LO
NF B02000 ⊕ 2NC R
NF G02000 ⊕ 2NC L
NF B20000 ⊕ 2NO R
NF G20000 ⊕ 2NO L
NF B12000 ⊕ 1NO+2NC R
NF G12000 ⊕ 1NO+2NC L
NF L12000 ⊕ 1NO+2NC LA
NF H12000 ⊕ 1NO+2NC LO
NF B22000 ⊕ 2NO+2NC R
NF G22000 ⊕ 2NO+2NC L
NF L22000 ⊕ 2NO+2NC LA
NF H22000 ⊕ 2NO+2NC LO

Technopolymer connector with cable	cable length (m)
VN CP11DN2	2
VN CP11DN5	5
VN CP02DN2	2
VN CP02DN5	5
/	/
/	/
VN CP12DN2	2
VN CP12DN5	5
VN CP22DN2	2
VN CP22DN5	5

⚠ It is forbidden to install VN CM••••• connectors on technopolymer housings

⚠ It is forbidden to install VN CP••••• connectors on metal housings



- VN AA0CP** ⊕ Unidirectional roller lever
- VN AA0CV** ⊕ Adjustable angled roller lever
- VN AA0EB** ⊕ Plunger with M12 threaded head
- VN AA0EE** ⊕ Plunger with M12 threaded head with external gasket
- VN AA0FB** ⊕ Roller plunger with M12 threaded head
- VN AA0GB** ⊕ Plunger with Ø 6 mm ball
- VN AA0HB** Flexible rod with plastic tip
- VN AA0HE** Flexible rod
- VN AA0HH** Flexible rod with needle

- VN A00KG** ⊕ Adjustable metal swivelling lever, shaped, with roller Ø 20 mm
- VN A00KH** ⊕ Adjustable metal swivelling lever, shaped, with roller Ø 20 mm
- VN A00KP** ⊕ Metal swivelling lever, straight, with roller Ø 20 mm, extended adjustment
- VN A00LB** Adjustable metal swivelling lever with stainless steel rod 3x3x125
- VN A00LE** Adjustable metal swivelling lever with stainless steel rod Ø3x125
- VN A00LH** Adjustable metal swivelling lever with fiber glass rod Ø6x200
- VN A00LL** Metal swivelling lever with adjustable flexible rod
- VN A00LP** ⊕ Metal swivelling lever with porcelain roll

Article code composition examples

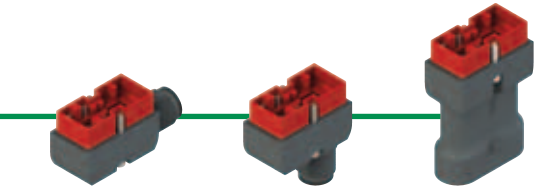
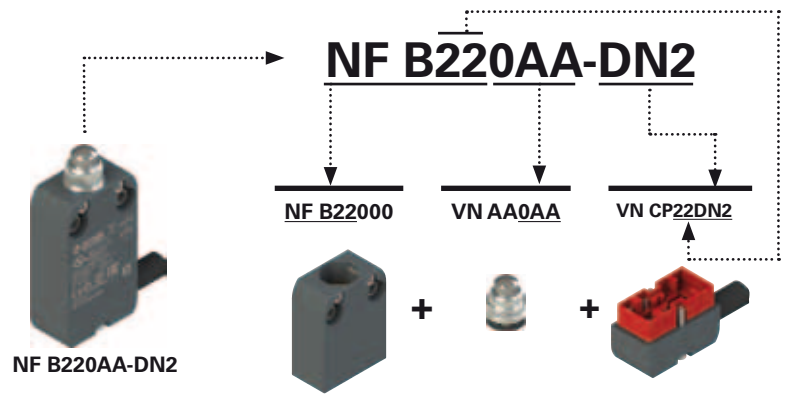

M12 technopolymer connector, right	M12 technopolymer connector, bottom	AMP technopolymer connector, bottom
↔ VN CP11DMK	↔ VN CP11SMK	↔ VN CP11SAK
↔ VN CP02DMK	↔ VN CP02SMK	↔ VN CP02SAK
↔ VN CP20DMK	↔ VN CP20SMK	↔ VN CP20SAK
↔ VN CP22DMK	↔ VN CP22SMK	
↔		

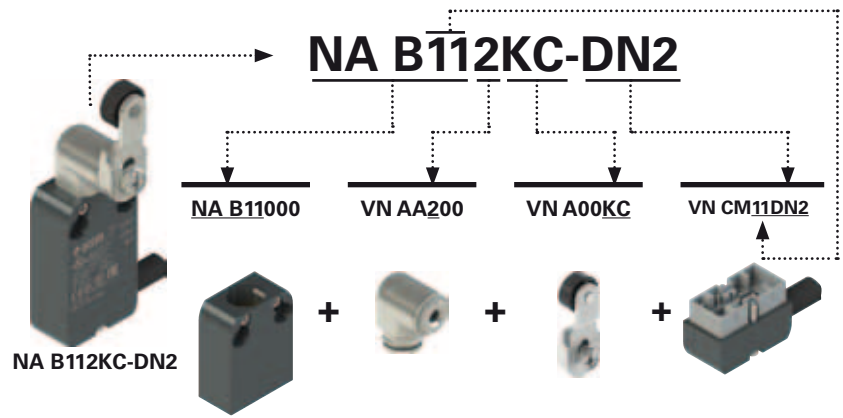

⚠ Installation for safety applications:
 To obtain a safety switch with positive opening ⊕, only join housings bearing the positive opening symbol next to the code ⊕ to actuators bearing the positive opening symbol next to the code ⊕.
 Example: **VN A00KB** ⊕ + **VN AA200** ⊕ + **NA B11000** ⊕

Housings

All measures in the drawings are in mm

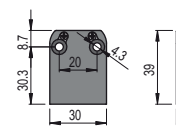
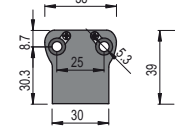
NA metal housing	metal housing NB
	
NA B11000 ⊕ 1NO+1NC R	NB B11000 ⊕ 1NO+1NC R
NA G11000 ⊕ 1NO+1NC L	NB G11000 ⊕ 1NO+1NC L
NA B12000 ⊕ 1NO+2NC R	NB B12000 ⊕ 1NO+2NC R
NA G12000 ⊕ 1NO+2NC L	NB G12000 ⊕ 1NO+2NC L
NA L12000 ⊕ 1NO+2NC LA	NB L12000 ⊕ 1NO+2NC LA
NA B22000 ⊕ 2NO+2NC R	NB B22000 ⊕ 2NO+2NC R
NA G22000 ⊕ 2NO+2NC L	NB G22000 ⊕ 2NO+2NC L
NA L22000 ⊕ 2NO+2NC LA	NB L22000 ⊕ 2NO+2NC LA
NA H22000 ⊕ 2NO+2NC LO	NB H22000 ⊕ 2NO+2NC LO

Contact type:
R = snap action
L = slow action
LO = slow action overlapped
LA = slow action closer

Markings and quality marks:

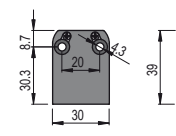

NF technopolymer housing

NF B11000 ⊕ 1NO+1NC R
NF G11000 ⊕ 1NO+1NC L
NF B12000 ⊕ 1NO+2NC R
NF G12000 ⊕ 1NO+2NC L
NF L12000 ⊕ 1NO+2NC LA
NF B22000 ⊕ 2NO+2NC R
NF G22000 ⊕ 2NO+2NC L
NF L22000 ⊕ 2NO+2NC LA
NF H22000 ⊕ 2NO+2NC LO

Connectors with cable

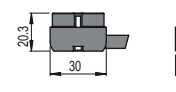
All measures in the drawings are in mm

metal connector for NA and NB housing	Cable length (m)	Cable type N = PVC H = PUR HALOGEN FREE
		
VN CM11DN2 1NO+1NC	2	N
VN CM11DN5 1NO+1NC	5	
VN CM12DN2 1NO+2NC	2	
VN CM12DN5 1NO+2NC	5	
VN CM22DN2 2NO+2NC	2	
VN CM22DN5 2NO+2NC	5	H
VN CM11DH2 1NO+1NC	2	
VN CM11DH5 1NO+1NC	5	
VN CM12DH2 1NO+2NC	2	
VN CM12DH5 1NO+2NC	5	

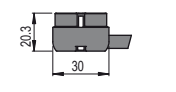
Other cable lengths on request

technopolymer connector for NF housing	Cable length (m)	Cable type N = PVC
		
VN CP11DN2 1NO+1NC	2	N
VN CP11DN5 1NO+1NC	5	
VN CP12DN2 1NO+2NC	2	
VN CP12DN5 1NO+2NC	5	
VN CP22DN2 2NO+2NC	2	
VN CP22DN5 2NO+2NC	5	

M12 or AMP connectors

All measures in the drawings are in mm

⚠ Important: Always check that the electric load used respects the voltage and current limits for the connectors. See tables on page 122 and 132

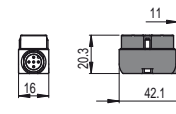
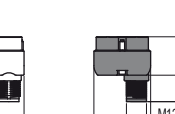
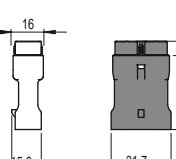
metal connectors for NA and NB housing	
M12 connector, right 	M12 connector, bottom 
VN CM11DMK 1NO+1NC	VN CM11SMK 1NO+1NC
VN CM02DMK 2NC	VN CM02SMK 2NC
VN CM22DMK 2NO+2NC	VN CM22SMK 2NO+2NC
technopolymer connectors for NA and NB housing	
AMP superseal 1.5 	
VN CM11SAK 1NO+1NC	
VN CM02SAK 2NC	
VN CM20SAK 2NO	

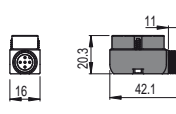
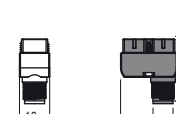
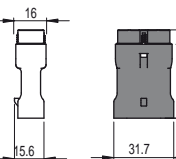
technopolymer connectors for NF housings	
M12 connector, right 	M12 connector, bottom 
VN CP11DMK 1NO+1NC	VN CP11SMK 1NO+1NC
VN CP02DMK 2NC	VN CP02SMK 2NC
VN CP22DMK 2NO+2NC	VN CP22SMK 2NO+2NC
AMP superseal 1.5 	
VN CP11SAK 1NO+1NC	
VN CP02SAK 2NC	
VN CP20SAK 2NO	

Items with code on green background are stock items

Accessories See page 225

→ The 2D/3D files are available at www.pizzato.com



Actuators

All measures in the drawings are in mm

 VN AA0AA	 VN AA0AB	 VN AA0AC	 VN AA0AE	 VN AA0BB	 VN AA0BE
 VN AA0CB	 VN AA0CH	 VN AA0CP	 VN AA0CV	 VN AA0EB	 VN AA0EE
 VN AA0FB	 VN AA0GB	 VN AA0HB	 VN AA0HE	 VN AA0HH	

Levers

All measures in the drawings are in mm

ATTENTION: These loose actuators can be used with products of series NA, NB and NF only.

 VN A00KA	 VN A00KB	 VN A00KC	 VN A00KD	 VN A00KE	 VN A00KF
 VN A00KG	 VN A00KH	 VN A00KP	 VN A00LB	 VN A00LE	 VN A00LH
 VN A00LL	 VN A00LP	Levers with stainless steel external metallic parts			
 VN A00KB-V38	 VN A00KE-V38	 VN A00KG-V38	 VN A00KP-V38		

Heads

 VN AA200

90° transmission block

 VN AA000-W5

Items with code on green background are stock items

Accessories See page 225

The 2D/3D files are available at www.pizzato.com

PIZZATO NF концевой выключатель **Минск** тел. **+375447584780**
www.fotorele.net www.tiristor.by радиодетали, электронные компоненты
email minsk17@tut.by tel.+375 29 758 47 80 МТС

Мы не работаем с частными (физическими) лицами.

Мы работаем только с юридическими лицами(организациями) и ИП и только по безналичному расчёту.

каталог, описание, технические, характеристики, datasheet, параметры, маркировка, габариты, фото, преобразователь, конвертор, dc-dc,
QR код



PIZZATO ELETTRICA NF B110BB-DMK / Limit switch; pusher
with parallel roller; NO + NC; IP67