

Мы не работаем с частными (физическими) лицами.

Мы работаем только с юридическими лицами(организациями) и ИП и только по безналичному расчёту.

каталог, описание, технические, характеристики, datasheet, параметры, маркировка, габариты, фото QR код

In-Socket (Parallel) Device Programmers and Socket Adapters Catalog

Cable-adapters for in-system programming (ISP)

- In-system programming adapters to be used with parallel device programmers

Adapters for parallel programming





Universal (1-to-1) adapters for parallel programming:

- DIP-PLCC universal adapters
- DIP-QFN, -MLF, -MLP, -CSP, WSON universal adapters
- DIP-QFP universal adapters
- DIP-SDIP universal adapters
- DIP-SOIC, -SOP universal adapters
- DIP-(T)SSOP universal adapters
- DIP-TSOP, -VSOP universal adapters

Specialized adapters for parallel programming of:

- Parallel EPROM, EEPROM, Flash memory devices
- Serial Flash memory devices
- NAND Flash memory devices
- Programmable Logical Devices (PLD)
- ARM microcontrollers
- Cortex microcontrollers
- 8051 microcontrollers
- 80196 microcontrollers
- PIC microcontrollers
- AVR microcontrollers
- MSP430 microcontrollers
- HC S08 and HC S12 microcontrollers
- ST7 and STM8 microcontrollers
- Other microcontrollers



DEVICE PROGRAMMERS

PART NUMBER	IMAGE	DESCRIPTION	DETAILS
ChipProg-40		USB interface, 40 pin socket	Device List
ChipProg-48		USB interface, 48 pin socket	Device List
ChipProg-481		USB interface, 48 pin socket	Device List
ChipProg-G41		USB interface, 48 pin sockets	Device List



DIP-PLCC UNIVERSAL ADAPTERS

PART NUMBER	IMAGE	DESCRIPTION	DEVICE LISTS
AE-P20U		DIP20/PLCC20 universal adapter with open top socket	ChipProg-40 ChipProg-48 ChipProg-481 ChipProg-G41
AE-P20U-Z		DIP20/PLCC20 universal adapter with clam shell socket	ChipProg-40 ChipProg-48 ChipProg-481 ChipProg-G41
AE-P28U		DIP28/PLCC28 universal adapter with open top socket	ChipProg-40 ChipProg-48 ChipProg-481 ChipProg-G41
AE-P28U-Z		DIP28/PLCC28 universal adapter with clam shell socket	ChipProg-40 ChipProg-48 ChipProg-481 ChipProg-G41
AE-P32U		DIP32/PLCC32 universal adapter with open top socket	ChipProg-40 ChipProg-48 ChipProg-481 ChipProg-G41
AE-P32U-Z		DIP32/PLCC32 universal adapter with clam shell socket	ChipProg-40 ChipProg-48 ChipProg-481 ChipProg-G41
AE-P44U		DIP44/PLCC44 universal adapter with open top socket	ChipProg-48 ChipProg-481 ChipProg-G41
AE-P44U-Z		DIP44/PLCC44 universal adapter with clam shell socket	ChipProg-48 ChipProg-481 ChipProg-G41

DIP-QFN, -MLF, -MLP, -CSP, WSON UNIVERSAL ADAPTERS



PART NUMBER	IMAGE	DESCRIPTION	DEVICE LISTS
AE-QFN16U-T		DIP18/QFN16 universal adapter	ChipProg-48 ChipProg-481 ChipProg-G41
AE-QFN16U2-T		DIP18/QFN16 universal adapter	ChipProg-48 ChipProg-481 ChipProg-G41
AE-QFN20U		DIP20/QFN20 universal adapter with clam shell socket	ChipProg-40 ChipProg-48 ChipProg-481

			ChipProg-G41		
AE-QFN24U		DIP24/QFN24 universal adapter with clam shell socket	ChipProg-48 ChipProg-481 ChipProg-G41		
AE-QFN28U		DIP28/QFN28 universal adapter with clam shell socket	ChipProg-40 ChipProg-48 ChipProg-481 ChipProg-G41		
AE-QFN28U2		DIP28/QFN28 universal adapter	ChipProg-48 ChipProg-481 ChipProg-G41		
AE-QFN32U1		DIP32/QFN32 universal adapter with clam shell socket	ChipProg-48 ChipProg-481 ChipProg-G41		
AE-QFN32U1-T		DIP32/QFN32 universal adapter with clam shell socket	ChipProg-48 ChipProg-481 ChipProg-G41		
AE-QFN32U2		DIP32/QFN32 universal adapter with open top socket	ChipProg-48 ChipProg-481 ChipProg-G41		
AE-QFN36U-T		DIP38/QFN36 universal adapter with clam shell socket	ChipProg-40 ChipProg-48 ChipProg-481 ChipProg-G41		
AE-QFN40U		DIP40/QFN40 universal adapter with open top socket	ChipProg-48 ChipProg-481 ChipProg-G41		
AE-QFN48U		DIP48/QFN48 universal adapter with open top socket	ChipProg-48 ChipProg-481 ChipProg-G41		
AE-QFN48U2		DIP48/QFN48 universal adapter with open top socket	ChipProg-48 ChipProg-481 ChipProg-G41		
AE-WS8-U1		DIP8/WSON8 universal adapter	ChipProg-40 ChipProg-48 ChipProg-481 ChipProg-G41		
AE-WS8-U2		DIP8/WSON8 universal adapter	ChipProg-40 ChipProg-48 ChipProg-481 ChipProg-G41		

AE-WS8-U3		DIP8/WSON8 universal adapter	ChipProg-40 ChipProg-48 ChipProg-481 ChipProg-G41
AE-WS8-U4		DIP8/WSON8 universal adapter	ChipProg-40 ChipProg-48 ChipProg-481 ChipProg-G41

Минск тел. +375447584780 minsk17@tut.by www.fotorele.net

DIP-QFP UNIVERSAL ADAPTERS

PART NUMBER	IMAGE	DESCRIPTION	DEVICE LISTS
AE-Q32U		DIP32/QFP32 universal adapter	ChipProg-40 ChipProg-48 ChipProg-481 ChipProg-G41
AE-Q44U		DIP44/QFP44 universal adapter	ChipProg-48 ChipProg-481 ChipProg-G41
AE-Q48U		DIP48/QFP48 universal adapter	ChipProg-48 ChipProg-481 ChipProg-G41





Минск тел. +375447584780 minsk17@tut.by www.fotorele.net

DIP-SDIP UNIVERSAL ADAPTERS

PART NUMBER	IMAGE	DESCRIPTION	DEVICE LISTS
AE-SD42U		DIP42/SDIP42 universal shrink DIP adapter	ChipProg-48 ChipProg-481 ChipProg-G41

Минск тел. +375447584780 minsk17@tut.by www.fotorele.net

DIP-SOIC, -SOP UNIVERSAL ADAPTERS

PART NUMBER	IMAGE	DESCRIPTION	DEVICE LISTS
AE-SC18/28U		DIP28/SOIC28 universal adapter	ChipProg-40 ChipProg-48 ChipProg-481 ChipProg-G41
AE-SC20U		DIP20/SOIC20 universal adapter	ChipProg-40 ChipProg-48 ChipProg-481 ChipProg-G41
AE-SC28U1		DIP28/SOIC28 universal adapter	ChipProg-40 ChipProg-48 ChipProg-481 ChipProg-G41
AE-SC32U		DIP32/SOIC32 universal adapter	ChipProg-48 ChipProg-481 ChipProg-G41
AE-SC8/16UM		DIP16/SOIC16 universal adapter	ChipProg-40



ChipProg-48
ChipProg-481
ChipProg-G41

AE-SC8/16UN



DIP16/SOIC16 universal adapter

ChipProg-40
ChipProg-48
ChipProg-481
ChipProg-G41

AE-SC8/16US



DIP16/SOIC16 universal adapter

ChipProg-40
ChipProg-48
ChipProg-481
ChipProg-G41

AE-SO44U



DIP44/SO44 universal adapter

ChipProg-48
ChipProg-481
ChipProg-G41

Минск тел. +375447584780 minsk17@tut.by www.fotorele.net

DIP-(T)SSOP UNIVERSAL ADAPTERS

**PART
NUMBER**

IMAGE

DESCRIPTION

DEVICE LISTS

AE-SOT23U



DIP6/SOT-23-6 universal adapter

ChipProg-48
ChipProg-481
ChipProg-G41

AE-SP28U1



DIP28/SSOP28 universal adapter

ChipProg-40
ChipProg-48
ChipProg-481
ChipProg-G41

AE-SP28U2



DIP28/SSOP28 universal adapter

ChipProg-40
ChipProg-48
ChipProg-481
ChipProg-G41

AE-SP28U3



DIP28/SSOP28 universal adapter

ChipProg-48
ChipProg-481
ChipProg-G41

AE-SP30U



DIP30/SSOP30 universal adapter

ChipProg-48
ChipProg-481
ChipProg-G41

AE-SP38U



DIP38/SSOP38 universal adapter

ChipProg-48
ChipProg-481
ChipProg-G41

AE-SP8U



DIP8/SSOP8 universal adapter

ChipProg-40
ChipProg-48
ChipProg-481
ChipProg-G41





AE-SS48U





DIP48/SSOP48 universal adapter







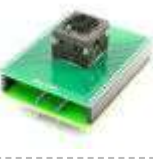
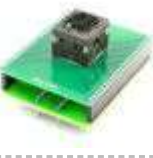
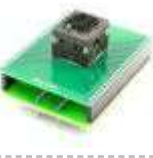
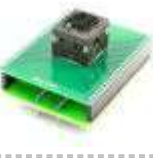
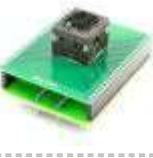

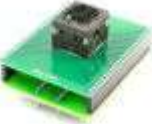
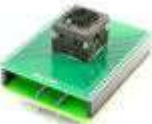
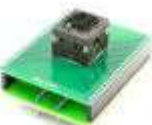

ChipProg-48
ChipProg-481
ChipProg-G41

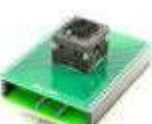
DIP-TSOP, -VSOP UNIVERSAL ADAPTERS

PART NUMBER	IMAGE	DESCRIPTION	DEVICE LISTS
AE-TS40N		DIP40/TSOP40 universal adapter	ChipProg-40 ChipProg-48 ChipProg-481 ChipProg-G41
AE-TS40W		DIP40/TSOP40 universal adapter	ChipProg-48 ChipProg-481 ChipProg-G41
AE-TS44U		DIP44/TSOP-II-44 universal adapter	ChipProg-48
AE-TS48U		DIP48/TSOP48 universal adapter	ChipProg-48 ChipProg-481 ChipProg-G41









PARALLEL EPROM, EEPROM, FLASH MEMORY DEVICES

PART NUMBER	IMAGE	DESCRIPTION	DEVICE LISTS
AE-B48-16MX3		DIP40/BGA48 specialized adapter for FLASH memory	ChipProg-40
AE-B48-16NM1		DIP40/BGA48 specialized adapter for FLASH memory	ChipProg-40
AE-B48-16SP1		DIP40/BGA48 specialized adapter for FLASH memory	ChipProg-40
AE-B48-16SP2		DIP40/BGA48 specialized adapter for FLASH memory	ChipProg-40
AE-B48-16SST1		DIP40/BGA48 specialized adapter for FLASH memory	ChipProg-40
AE-B48-8SP1		DIP40/BGA48 specialized adapter for FLASH memory	ChipProg-48 ChipProg-481 ChipProg-G41
AE-B48-MX3		DIP48/BGA48 specialized adapter for FLASH memory	ChipProg-48 ChipProg-481 ChipProg-G41
AE-B48-NM1		DIP48/BGA48 specialized adapter for	ChipProg-48

		FLASH memory	ChipProg-481 ChipProg-G41		
AE-B48-SP1		DIP48/BGA48 specialized adapter for FLASH memory	ChipProg-48 ChipProg-481 ChipProg-G41		
AE-B48-SP2		DIP48/BGA48 specialized adapter for FLASH memory	ChipProg-48 ChipProg-481 ChipProg-G41		
AE-B56-MX1		DIP40/BGA56 specialized adapter for FLASH memory	ChipProg-40 ChipProg-48 ChipProg-481 ChipProg-G41		
AE-B56-MX2		DIP40/BGA56 specialized adapter for FLASH memory	ChipProg-40 ChipProg-48 ChipProg-481 ChipProg-G41		
AE-B56-NM1		DIP40/BGA56 specialized adapter for FLASH memory	ChipProg-40 ChipProg-48 ChipProg-481 ChipProg-G41		
AE-B56-SP1		DIP40/BGA56 specialized adapter for FLASH memory	ChipProg-40 ChipProg-48 ChipProg-481 ChipProg-G41		
AE-B56-SP2		DIP40/BGA56 specialized adapter for FLASH memory	ChipProg-40 ChipProg-48 ChipProg-481 ChipProg-G41		
AE-B56-SP3		DIP40/BGA56 specialized adapter for FLASH memory	ChipProg-40 ChipProg-48 ChipProg-481 ChipProg-G41		
AE-B64-MX2		DIP40/BGA64 specialized adapter for FLASH memory	ChipProg-40 ChipProg-48 ChipProg-481 ChipProg-G41		
AE-B64-NM2		DIP40/BGA64 specialized adapter for FLASH memory	ChipProg-40 ChipProg-48 ChipProg-481 ChipProg-G41		
AE-B64-NM3		DIP40/BGA64 specialized adapter for FLASH memory	ChipProg-40 ChipProg-48 ChipProg-481 ChipProg-G41		
AE-B64-NM4		DIP40/BGA64 specialized adapter for FLASH memory	ChipProg-40 ChipProg-48 ChipProg-481 ChipProg-G41		

AE-B64-SP1		DIP40/BGA64 specialized adapter for FLASH memory	ChipProg-40 ChipProg-48 ChipProg-481 ChipProg-G41		
AE-B64-SP2		DIP40/BGA64 specialized adapter for FLASH memory	ChipProg-40 ChipProg-48 ChipProg-481 ChipProg-G41		
AE-B64-SP3		DIP40/BGA64 specialized adapter for FLASH memory	ChipProg-40 ChipProg-48 ChipProg-481 ChipProg-G41		
AE-B64-SP4		DIP40/BGA64 specialized adapter for FLASH memory	ChipProg-40 ChipProg-48 ChipProg-481 ChipProg-G41		
AE-B64-SP5		DIP40/BGA64 specialized adapter for FLASH memory	ChipProg-40 ChipProg-48 ChipProg-481 ChipProg-G41		
AE-B84-SP1		DIP40/BGA84 specialized adapter for FLASH memory	ChipProg-40 ChipProg-48 ChipProg-481 ChipProg-G41		
AE-B84-SP3		DIP40/BGA84 specialized adapter for FLASH memory	ChipProg-40 ChipProg-48 ChipProg-481 ChipProg-G41		
AE-B88-NM1		DIP40/BGA88 specialized adapter for FLASH memory	ChipProg-40 ChipProg-48 ChipProg-481 ChipProg-G41		
AE-B88-SP3		DIP40/BGA88 specialized adapter for FLASH memory	ChipProg-40 ChipProg-48 ChipProg-481 ChipProg-G41		
AE-P32-28		DIP28/PLCC32 specialized adapter for EPROM/FLASH with open top socket	ChipProg-40 ChipProg-48 ChipProg-481 ChipProg-G41		
AE-P32-28-Z		DIP28/PLCC32 specialized adapter for EPROM/FLASH with clam shell socket	ChipProg-40 ChipProg-48 ChipProg-481 ChipProg-G41		
AE-P32-CP49		DIP32/PLCC32 specialized adapter for EPROM/FLASH with open top socket	ChipProg-40		
AE-P32-CP49-Z		DIP32/PLCC32 specialized adapter for EPROM/FLASH with clam shell socket	ChipProg-40		

AE-P44-4096		DIP40/PLCC44 specialized adapter for EPROM/FLASH with open top socket	ChipProg-40 ChipProg-48 ChipProg-481 ChipProg-G41		
AE-P44-4096-Z		DIP40/PLCC44 specialized adapter for EPROM/FLASH with clam shell socket	ChipProg-40 ChipProg-48 ChipProg-481 ChipProg-G41		
AE-Q80-F32		DIP40/QFP80 specialized adapter for 32-bit Flash memory	ChipProg-40 ChipProg-48 ChipProg-481 ChipProg-G41		
AE-SO44-16		DIP40/SO44 specialized adapter for FLASH memory	ChipProg-40		
AE-SS56-16Am		DIP40/SSOP56 specialized adapter for FLASH memory	ChipProg-40		
AE-SS56-16Am-2		DIP40/SSOP56 specialized adapter for FLASH memory	ChipProg-40 ChipProg-48 ChipProg-481 ChipProg-G41		
AE-SS56-16I		DIP40/SSOP56 specialized adapter for FLASH memory	ChipProg-40 ChipProg-48 ChipProg-481 ChipProg-G41		
AE-SS56-16I-2		DIP40/SSOP56 specialized adapter for FLASH memory	ChipProg-40 ChipProg-48 ChipProg-481 ChipProg-G41		
AE-TS28		DIP28/TSOP28 specialized adapter for Flash memory	ChipProg-40 ChipProg-48 ChipProg-481 ChipProg-G41		
AE-TS32N		DIP32/TSOP32 specialized adapter for Flash memory	ChipProg-40 ChipProg-48 ChipProg-481 ChipProg-G41		
AE-TS32N-CP49		DIP32/TSOP32 specialized adapter	ChipProg-40		
AE-TS32W		DIP32/TSOP32 specialized adapter for Flash memory	ChipProg-40 ChipProg-48 ChipProg-481 ChipProg-G41		
AE-TS40N-2		DIP40/TSOP40 specialized adapter	ChipProg-40		

AE-TS40W-2		DIP40/TSOP40 specialized adapter	ChipProg-40		
AE-TS40W-CP49		DIP40/TSOP40 specialized adapter	ChipProg-40		
AE-TS48-16		DIP40/TSOP48 specialized adapter	ChipProg-40		
AE-TS48-16Am		DIP40/TSOP48 specialized adapter	ChipProg-40		
AE-TS48-16AT1024		DIP40/TSOP48 specialized adapter	ChipProg-40		
AE-TS56-16Am		DIP40/TSOP56 specialized adapter for FLASH memory	ChipProg-40 ChipProg-48 ChipProg-481 ChipProg-G41		
AE-TS56-16I		DIP40/TSOP56 specialized adapter for FLASH memory	ChipProg-40 ChipProg-48 ChipProg-481 ChipProg-G41		
AE-TS56-16I-2		DIP40/TSOP56 specialized adapter for FLASH memory	ChipProg-40 ChipProg-48 ChipProg-481 ChipProg-G41		
AE-TS56-16I-3		DIP40/TSOP56 specialized adapter for FLASH memory	ChipProg-40 ChipProg-48 ChipProg-481 ChipProg-G41		
AE-TS56-16I-4		DIP40/TSOP56 specialized adapter for FLASH memory	ChipProg-40 ChipProg-48 ChipProg-481 ChipProg-G41		
AE-TS56-16I-5		DIP40/TSOP56 specialized adapter for FLASH memory	ChipProg-48 ChipProg-481 ChipProg-G41		

Минск тел. +375447584780 minsk17@tut.by www.fotorele.net

SERIAL FLASH MEMORY DEVICES

PART NUMBER	IMAGE	DESCRIPTION	DEVICE LISTS		
AE-B24-25XX		DIP8/BGA24 specialized adapter for FLASH memory 25xx family	ChipProg-40 ChipProg-48 ChipProg-481 ChipProg-G41		





AE-B24-25XX-2		DIP24/BGA24 specialized adapter for FLASH memory 25xx family	ChipProg-40 ChipProg-48 ChipProg-481 ChipProg-G41		
AE-B24-25XX-3		DIP24/BGA24 specialized adapter for FLASH memory 25xx family	ChipProg-40 ChipProg-48 ChipProg-481 ChipProg-G41		
AE-IB-F5		DIP20/iButton-F5 specialized adapter for Maxim/Dallas iButton Chips	ChipProg-40 ChipProg-48 ChipProg-481 ChipProg-G41		
AE-P44-AT17		DIP20/PLCC44 specialized adapter for Atmel AT17xxx devices with open top socket	ChipProg-40 ChipProg-48 ChipProg-481 ChipProg-G41		
AE-P44-AT17-Z		DIP20/PLCC44 specialized adapter for Atmel AT17xxx devices with clam shell socket	ChipProg-40 ChipProg-48 ChipProg-481 ChipProg-G41		
AE-P44-XC17		DIP20/PLCC44 specialized adapter for Xilinx devices with open top socket	ChipProg-48 ChipProg-481 ChipProg-G41		
AE-P44-XC17-Z		DIP20/PLCC44 specialized adapter for Xilinx devices with open top socket	ChipProg-48 ChipProg-481 ChipProg-G41		
AE-Q44-AT17N		DIP40/QFP44 specialized adapter for Atmel devices	ChipProg-40 ChipProg-48 ChipProg-481 ChipProg-G41		
AE-Q44-XC17		DIP20/QFP44 specialized adapter for Xilinx devices	ChipProg-48 ChipProg-481 ChipProg-G41		
AE-SC18/28-25XX-2		DIP28/SOIC28 specialized adapter for 25XX serial EEPROM, FLASH	ChipProg-48 ChipProg-481 ChipProg-G41		
AE-SC18/28-25XX-3		DIP28/SOIC28 specialized adapter for 25XX serial EEPROM, FLASH	ChipProg-48 ChipProg-481 ChipProg-G41		
AE-SC8/16M-25XX-2		DIP16/SOIC16 specialized adapter for 25XX serial EEPROM, FLASH	ChipProg-481 ChipProg-G41		
AE-SC8/16M-25XX-3		DIP16/SOIC16 specialized adapter for 25XX serial EEPROM, FLASH	ChipProg-40 ChipProg-48 ChipProg-481 ChipProg-G41		

AE-SC8/16N-25XX-2		DIP16/SOIC16 specialized adapter for 25XX serial EEPROM, FLASH	ChipProg-481 ChipProg-G41		
AE-SOT23-24XX		DIP8/SOT-23-6 specialized adapter for 24XXX serial FLASH	ChipProg-40 ChipProg-48 ChipProg-481 ChipProg-G41		
AE-SOT23-93XX		DIP8/SOT-23-6 specialized adapter for 93XXX serial FLASH	ChipProg-40 ChipProg-48 ChipProg-481 ChipProg-G41		
AE-TS28		DIP28/TSOP28 specialized adapter for Flash memory	ChipProg-40 ChipProg-48 ChipProg-481 ChipProg-G41		
AE-TS28-45XX		DIP28/TSOP28 specialized adapter for Atmel AT45xx devices	ChipProg-48 ChipProg-481 ChipProg-G41		
AE-TS32W		DIP32/TSOP32 specialized adapter for Flash memory	ChipProg-40 ChipProg-48 ChipProg-481 ChipProg-G41		
AE-WS8-25XX-21		DIP8/WS8 specialized adapter for 25xx serial EEPROM, FLASH memory	ChipProg-481 ChipProg-G41		
AE-WS8-25XX-22		DIP8/WS8 specialized adapter for 25xx serial EEPROM, FLASH memory	ChipProg-481 ChipProg-G41		
AE-WS8-25XX-23		DIP8/WS8 specialized adapter for 25xx serial EEPROM, FLASH memory	ChipProg-481 ChipProg-G41		
AE-WS8-25XX-24		DIP8/WS8 specialized adapter for 25xx serial EEPROM, FLASH memory	ChipProg-481 ChipProg-G41		
AE-WS8-25XX-31		DIP8/WS8 specialized adapter for 25xx serial EEPROM, FLASH memory	ChipProg-40 ChipProg-48 ChipProg-481 ChipProg-G41		
AE-WS8-25XX-32		DIP8/WS8 specialized adapter for 25xx serial EEPROM, FLASH memory	ChipProg-481 ChipProg-G41		

Минск тел. +375447584780 minsk17@tut.by www.fotorele.net

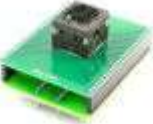
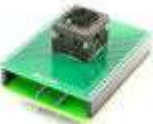
NAND FLASH MEMORY DEVICES

PART NUMBER	IMAGE	DESCRIPTION	DEVICE LISTS		
-------------	-------	-------------	--------------	--	--

AE-B55-NAND-3		DIP40/BGA55 specialized adapter for NAND FLASH memory	ChipProg-40 ChipProg-48 ChipProg-481 ChipProg-G41		
AE-B63-NAND-1		DIP40/BGA63 specialized adapter for NAND FLASH memory	ChipProg-40 ChipProg-48 ChipProg-481 ChipProg-G41		
AE-B63-NAND-2		DIP40/BGA63 specialized adapter for NAND FLASH memory	ChipProg-40 ChipProg-48 ChipProg-481 ChipProg-G41		
AE-TS44Am		DIP40/TSOP-II-44 specialized adapter	ChipProg-48 ChipProg-481 ChipProg-G41		
AE-TS48-NAND-4		DIP40/TSOP48 specialized adapter for NAND Flash devices	ChipProg-40 ChipProg-48 ChipProg-481 ChipProg-G41		

Минск тел. +375447584780 minsk17@tut.by www.fotorele.net



PROGRAMMABLE LOGICAL DEVICES (PLD)

PART NUMBER	IMAGE	DESCRIPTION	DEVICE LISTS		
AE-P44-A32/64		DIP40/PLCC44 specialized adapter for Altera EPMxxx devices with open top socket	ChipProg-48 ChipProg-481 ChipProg-G41		
AE-P44-A32/64-Z		DIP40/PLCC44 specialized adapter for Altera EPMxxx devices with clam shell socket	ChipProg-48 ChipProg-481 ChipProg-G41		
AE-P44-ATF2500		DIP40/PLCC44 specialized adapter for Atmel ATF2500 devices with open top socket	ChipProg-48 ChipProg-481 ChipProg-G41		
AE-P44-ATF2500-Z		DIP40/PLCC44 specialized adapter for Atmel ATF2500 devices with clam shell socket	ChipProg-48 ChipProg-481 ChipProg-G41		
AE-P44-PLD		DIP40/PLCC44 specialized adapter PLD devices with open top socket	ChipProg-48 ChipProg-481 ChipProg-G41		
AE-P44-PLD-Z		DIP40/PLCC44 specialized adapter PLD devices with clam shell socket	ChipProg-48 ChipProg-481 ChipProg-G41		
AE-P84-A128		DIP40/PLCC84 specialized adapter for Altera EPMxxx devices with open top socket	ChipProg-48 ChipProg-481 ChipProg-G41		

AE-P84-A128-Z		DIP40/PLCC84 specialized adapter for Altera EPMxxx devices with clam shell socket	ChipProg-48 ChipProg-481 ChipProg-G41		
AE-P84-A64		DIP40/PLCC84 specialized adapter for Altera EPMxxx devices with open top socket	ChipProg-48 ChipProg-481 ChipProg-G41		
AE-P84-A64-Z		DIP40/PLCC84 specialized adapter for Altera EPMxxx devices with clam shell socket	ChipProg-48 ChipProg-481 ChipProg-G41		
AE-Q100-A3064		DIP40/QFP100 specialized adapter for Altera devices	ChipProg-48 ChipProg-481 ChipProg-G41		
AE-Q100-MAX2		DIP40/QFP100 specialized adapter for Altera devices	ChipProg-48 ChipProg-481 ChipProg-G41		
AE-Q144-A3128		DIP48/QFP144 specialized adapter for Altera devices	ChipProg-48 ChipProg-481 ChipProg-G41		
AE-Q144-MAX2		DIP48/QFP144 specialized adapter for Altera devices	ChipProg-48 ChipProg-481 ChipProg-G41		
AE-Q44-A32/64		DIP40/QFP44 specialized adapter for Altera devices	ChipProg-48 ChipProg-481 ChipProg-G41		
AE-Q44-X36		DIP40/QFP44 specialized adapter for Xilinx devices	ChipProg-48 ChipProg-481 ChipProg-G41		
M-P44-40x		DIP40/PLCC44 specialized adapter for Xilinx devices with open top socket	ChipProg-48 ChipProg-481 ChipProg-G41		

Минск тел. +375447584780 minsk17@tut.by www.fotorele.net





ARM MICROCONTROLLERS

PART NUMBER	IMAGE	DESCRIPTION	DEVICE LISTS		
AE-Q100-LPC2000-1		DIP40/QFP100 specialized adapter for NXP/Philips microcontrollers	ChipProg-48 ChipProg-481 ChipProg-G41		
AE-Q100-SAM7		DIP40/QFP100 specialized adapter for Atmel microcontrollers	ChipProg-40 ChipProg-48 ChipProg-481 ChipProg-G41		

AE-Q144-LPC2000-1		DIP40/QFP144 specialized adapter for NXP/Philips microcontrollers	ChipProg-48 ChipProg-481 ChipProg-G41		
AE-Q144-LPC2000-2		DIP40/QFP144 specialized adapter for NXP/Philips microcontrollers	ChipProg-48 ChipProg-481 ChipProg-G41		
AE-Q48-SAM7		DIP40/QFP48 specialized adapter for Atmel microcontrollers	ChipProg-40		
AE-Q64-ADUC7		DIP40/QFP64 specialized adapter for Analog Devices ADUC7xxx microcontrollers	ChipProg-48 ChipProg-481 ChipProg-G41		
AE-Q64-LPC2000		DIP40/QFP64 specialized adapter for NXP/Philips microcontrollers	ChipProg-48 ChipProg-481 ChipProg-G41		
AE-Q64-SAM7		DIP40/QFP64 specialized adapter for Atmel microcontrollers	ChipProg-40 ChipProg-48 ChipProg-481 ChipProg-G41		
AE-QFN48-SAM7		DIP40/QFN48 specialized adapter for Atmel microcontrollers	ChipProg-40		
AE-QFN64-SAM7		DIP40/QFN64 specialized adapter for Atmel microcontrollers	ChipProg-40 ChipProg-48 ChipProg-481 ChipProg-G41		

Минск тел. +375447584780 minsk17@tut.by www.fotorele.net

CORTEX MICROCONTROLLERS





PART NUMBER	IMAGE	DESCRIPTION	DEVICE LISTS		
AE-B144-KIN		DIP40/BGA144 specialized adapter for Freescale microcontrollers	ChipProg-48 ChipProg-481 ChipProg-G41		
AE-B180-LPC		DIP40/BGA180 specialized adapter for NXP microcontrollers	ChipProg-48 ChipProg-481 ChipProg-G41		
AE-B47-QN9083		DIP48/WLCSP47 specialized adapter for QN9083 microcontrollers	ChipProg-48 ChipProg-481 ChipProg-G41		
AE-Q100-CY8C38		DIP40/QFP100 specialized adapter for Cypress microcontrollers	ChipProg-48 ChipProg-481 ChipProg-G41		

AE-Q100-EFM32		DIP40/QFP100 specialized adapter for Energy Micro EFM32 microcontrollers	ChipProg-40 ChipProg-48 ChipProg-481 ChipProg-G41		
AE-Q100-KIN		DIP40/QFP100 specialized adapter for Freescale microcontrollers	ChipProg-48 ChipProg-481 ChipProg-G41		
AE-Q100-LM3S		DIP28/QFP100 specialized adapter for TI/Luminary microcontrollers	ChipProg-40 ChipProg-48 ChipProg-481 ChipProg-G41		
AE-Q100-LPC1517		DIP40/QFP100 specialized adapter for NXP/Philips microcontrollers	ChipProg-48 ChipProg-481 ChipProg-G41		
AE-Q100-LPC2000-1		DIP40/QFP100 specialized adapter for NXP/Philips microcontrollers	ChipProg-48 ChipProg-481 ChipProg-G41		
AE-Q100-MB9B		DIP40/QFP100 specialized adapter for Fujitsu microcontrollers	ChipProg-48 ChipProg-481 ChipProg-G41		
AE-Q100-MSP432		DIP40/QFP100 specialized adapter for TI microcontrollers	ChipProg-48 ChipProg-481 ChipProg-G41		
AE-Q100-NUC		DIP40/QFP100 specialized adapter for Nuvoton (Cortex M0) microcontrollers	ChipProg-48 ChipProg-481 ChipProg-G41		
AE-Q100-SAM3		DIP40/QFP100 specialized adapter for Atmel microcontrlers	ChipProg-48 ChipProg-481 ChipProg-G41		
AE-Q100-SAM3-3		DIP40/QFP100 specialized adapter for Atmel microcontrlers	ChipProg-48 ChipProg-481 ChipProg-G41		
AE-Q100-STM32		DIP40/QFP100 specialized adapter for STMicro STM32 microcontrollers	ChipProg-40 ChipProg-48 ChipProg-481 ChipProg-G41		
AE-Q100-STM32-2		DIP40/QFP100 specialized adapter for STMicro STM32 microcontrollers	ChipProg-40 ChipProg-48 ChipProg-481 ChipProg-G41		
AE-Q100-STM32-3		DIP40/QFP100 specialized adapter for STMicro STM32 microcontrollers	ChipProg-40 ChipProg-48 ChipProg-481 ChipProg-G41		

AE-Q100-TIVA		DIP40/QFP100 specialized adapter for Ti TIVA microcontrllers	ChipProg-48 ChipProg-481 ChipProg-G41		
AE-Q144-KIN		DIP40/QFP144 specialized adapter for Freescale microcontrollers	ChipProg-48 ChipProg-481 ChipProg-G41		
AE-Q144-LPC2000-2		DIP40/QFP144 specialized adapter for NXP/Philips microcontrollers	ChipProg-48 ChipProg-481 ChipProg-G41		
AE-Q144-STM32		DIP40/QFP144 specialized adapter for STMicro STM32 microcontrollers	ChipProg-40 ChipProg-48 ChipProg-481 ChipProg-G41		
AE-Q144-STM32-2		DIP40/QFP144 specialized adapter for STMicro STM32 microcontrollers	ChipProg-40 ChipProg-48 ChipProg-481 ChipProg-G41		
AE-Q144-TIVA		DIP40/QFP144 specialized adapter for Ti Tiva microcontrollers	ChipProg-48 ChipProg-481 ChipProg-G41		
AE-Q48-EFM32		DIP40/QFP48 specialized adapter for Energy Micro EFM32	ChipProg-40 ChipProg-48 ChipProg-481 ChipProg-G41		
AE-Q48-LM3S		DIP28/QFP48 specialized adapter for TI/Luminary microcontrollers	ChipProg-40 ChipProg-48 ChipProg-481 ChipProg-G41		
AE-Q48-SAM3-1		DIP40/QFP48 specialized adapter for Atmel microcontrollers	ChipProg-48 ChipProg-481 ChipProg-G41		
AE-Q48-STM32		DIP40/QFP48 specialized adapter for STMicro STM32 microcontrollers	ChipProg-40 ChipProg-48 ChipProg-481 ChipProg-G41		
AE-Q64-EFM32		DIP40/QFP64 specialized adapter for Energy Micro EFM32 microcontrollers	ChipProg-40 ChipProg-48 ChipProg-481 ChipProg-G41		
AE-Q64-KIN		DIP40/QFP64 specialized adapter for Motorola/Freescale microcontrollers	ChipProg-48 ChipProg-481 ChipProg-G41		
AE-Q64-KIN-E		DIP40/QFP64 specialized adapter for Motorola/Freescale microcontrollers	ChipProg-48 ChipProg-481 ChipProg-G41		









AE-Q64-KIN-E1		DIP40/QFP64 specialized adapter for Motorola/Freescale microcontrollers	ChipProg-48 ChipProg-481 ChipProg-G41		
AE-Q64-LM3S		DIP28/QFP64 specialized adapter for TI/Luminary microcontrollers	ChipProg-40 ChipProg-48 ChipProg-481 ChipProg-G41		
AE-Q64-MIL		DIP40/QFP4 specialized adapter for MILANDR 1986BE92Y microcontroller	ChipProg-48 ChipProg-481 ChipProg-G41		
AE-Q64-NUC		DIP40/QFP64 specialized adapter for Nuvoton (Cortex M0) microcontrollers	ChipProg-48 ChipProg-481 ChipProg-G41		
AE-Q64-PSOC4-1		DIP40/QFP64 specialized adapter for Cypress microcontrollers	ChipProg-48 ChipProg-481 ChipProg-G41		
AE-Q64-PSOC4-2			ChipProg-48 ChipProg-481 ChipProg-G41		
AE-Q64-SAM3-1		DIP40/QFP64 specialized adapter for Atmel microcontrollers	ChipProg-48 ChipProg-481 ChipProg-G41		
AE-Q64-SAMD20		DIP40/QFP64 specialized adapter for Atmel microcontrollers	ChipProg-48 ChipProg-481 ChipProg-G41		
AE-Q64-SIM3		DIP40/QFP64 specialized adapter for Silicon Labs Cortex microcontrollers	ChipProg-48 ChipProg-481 ChipProg-G41		
AE-Q64-STM32		DIP40/QFP64 specialized adapter for STMicro STM32 microcontrollers	ChipProg-40 ChipProg-48 ChipProg-481 ChipProg-G41		
AE-Q64-STM32-2		DIP40/QFP64 specialized adapter for STMicro STM32 microcontrollers	ChipProg-40 ChipProg-48 ChipProg-481 ChipProg-G41		
AE-Q64-STM32-3		DIP40/QFP64 specialized adapter for STMicro STM32 microcontrollers	ChipProg-40 ChipProg-48 ChipProg-481 ChipProg-G41		
AE-Q64-TIVA		DIP40/QFP64 specialized adapter for Ti TIVA microcontrollers	ChipProg-48 ChipProg-481 ChipProg-G41		

AE-Q80-KIN-1		DIP40/QFP80 specialized adapter for Motorola/Freescale microcontrollers	ChipProg-48 ChipProg-481 ChipProg-G41		
AE-Q80-KIN-2		DIP40/QFP80 specialized adapter for Motorola/Freescale microcontrollers	ChipProg-48 ChipProg-481 ChipProg-G41		
AE-Q80-KIN-E		DIP40/QFP80 specialized adapter for Motorola/Freescale microcontrollers	ChipProg-48 ChipProg-481 ChipProg-G41		
AE-Q80-LPC1700		DIP40/QFP80 specialized adapter for NXP/Philips microcontrollers	ChipProg-48 ChipProg-481 ChipProg-G41		
AE-Q80-SIM3		DIP40/QFP80 specialized adapter for Silicon Labs Cortex microcontrollers	ChipProg-48 ChipProg-481 ChipProg-G41		
AE-QFN32U2-T		DIP32/QFN32 universal adapter with open top socket	ChipProg-40 ChipProg-48 ChipProg-481 ChipProg-G41		
AE-QFN40-SIM3		DIP40/QFN40 specialized adapter for Silicon Labs Cortex microcontrollers	ChipProg-48 ChipProg-481 ChipProg-G41		
AE-QFN48-SAM3-1		DIP40/QFN48 specialized adapter for Atmel microcontrollers	ChipProg-48 ChipProg-481 ChipProg-G41		
AE-QFN48-STM32		DIP40/QFN48 specialized adapter for STMicro STM32 microcontrollers	ChipProg-40 ChipProg-48 ChipProg-481 ChipProg-G41		
AE-QFN48-STM32-2		DIP40/QFN48 specialized adapter for STMicro STM32 microcontrollers	ChipProg-48 ChipProg-481 ChipProg-G41		
AE-QFN64-EFM32		DIP40/QFN64 specialized adapter for Energy Micro EFM32 microcontrollers	ChipProg-40 ChipProg-48 ChipProg-481 ChipProg-G41		
AE-QFN64-SAM3-1		DIP40/QFN64 specialized adapter for Atmel microcontrollers	ChipProg-48 ChipProg-481 ChipProg-G41		
AE-QFN64-SAMD20		DIP40/QFN64 specialized adapter for Atmel microcontrollers	ChipProg-48 ChipProg-481 ChipProg-G41		

AE-QFN64-SIM3		DIP40/QFN64 specialized adapter for Silicon Labs Cortex microcontrollers	ChipProg-48 ChipProg-481 ChipProg-G41
AE-QFN68-CY8C38		DIP40/QFN68 specialized adapter for Microchip PIC microcontrollers	ChipProg-48 ChipProg-481 ChipProg-G41
AE-QFN68-MARV		DIP40/QFN68 specialized adapter for Marvell 88MC200 microcontrollers	ChipProg-48 ChipProg-481 ChipProg-G41
AE-QFN68-PSOC4		DIP40/QFN68 specialized adapter for Cypress microcontrollers	ChipProg-48 ChipProg-481 ChipProg-G41



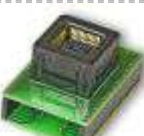



Минск тел. +375447584780 minsk17@tut.by www.fotorele.net

8051 MICROCONTROLLERS

PART NUMBER	IMAGE	DESCRIPTION	DEVICE LISTS
AE-P44-C541		DIP40/PLCC44 specialized adapter with open top socket	ChipProg-40 ChipProg-48 ChipProg-481 ChipProg-G41
AE-P44-C541-Z		DIP40/PLCC44 specialized adapter with clam shell socket	ChipProg-40 ChipProg-48 ChipProg-481 ChipProg-G41
AE-P44-i51		DIP40/PLCC44 specialized adapter for microcontrollers with open top socket	ChipProg-40 ChipProg-48 ChipProg-481 ChipProg-G41
AE-P44-i51-Z		DIP40/PLCC44 specialized adapter for microcontrollers with clam shell socket	ChipProg-40 ChipProg-48 ChipProg-481 ChipProg-G41
AE-P44-LP6440		DIP40/PLCC44 specialized adapter for 8051 family microcontrollers with open top socket	ChipProg-40 ChipProg-48 ChipProg-481 ChipProg-G41
AE-P44-LP6440-Z		DIP40/PLCC44 specialized adapter for 8051 family microcontrollers with clam shell socket	ChipProg-40 ChipProg-48 ChipProg-481 ChipProg-G41
AE-P44-P591		DIP40/PLCC44 specialized adapter for Philips/NXP microcontrollers with open top socket	ChipProg-40 ChipProg-48 ChipProg-481 ChipProg-G41
AE-P44-P591-Z		DIP40/PLCC44 specialized adapter for Philips/NXP microcontrollers with clam shell socket	ChipProg-40 ChipProg-48 ChipProg-481 ChipProg-G41

AE-P44-P952		DIP28/PLCC44 specialized adapter for Philips/NXP microcontrollers with open top socket	ChipProg-40 ChipProg-48 ChipProg-481 ChipProg-G41		
AE-P44-P952-Z		DIP28/PLCC44 specialized adapter for Philips/NXP microcontrollers with clam shell socket	ChipProg-40 ChipProg-48 ChipProg-481 ChipProg-G41		
AE-P44-T51CC		DIP40/PLCC44 specialized adapter with open top socket	ChipProg-40 ChipProg-48 ChipProg-481 ChipProg-G41		
AE-P44-T51CC-Z		DIP40/PLCC44 specialized adapter with clam shell socket	ChipProg-40 ChipProg-48 ChipProg-481 ChipProg-G41		
AE-P44-W79		DIP40/PLCC44 specialized adapter for Nuvoton/Winbond microcontrollers with open top socket	ChipProg-40 ChipProg-48 ChipProg-481 ChipProg-G41		
AE-P44-W79-2		DIP40/PLCC44 specialized adapter for Nuvoton/Winbond microcontrollers with open top socket	ChipProg-40 ChipProg-48 ChipProg-481 ChipProg-G41		
AE-P44-W79-2-Z		DIP40/PLCC44 specialized adapter for Nuvoton/Winbond microcontrollers with clam shell socket	ChipProg-40 ChipProg-48 ChipProg-481 ChipProg-G41		
AE-P44-W79-Z		DIP40/PLCC44 specialized adapter for Nuvoton/Winbond microcontrollers with clam shell socket	ChipProg-40 ChipProg-48 ChipProg-481 ChipProg-G41		
AE-P52-d530		DIP40/PLCC52 specialized adapter for Dallas/Maxim microcontrollers with open top socket	ChipProg-40 ChipProg-48 ChipProg-481 ChipProg-G41		
AE-P52-d530-Z		DIP40/PLCC52 specialized adapter for Dallas/Maxim microcontrollers with clam shell socket	ChipProg-40 ChipProg-48 ChipProg-481 ChipProg-G41		
AE-P52-T5112		DIP40/PLCC52 specialized adapter for Atmel microcontrollers with open top socket	ChipProg-40 ChipProg-48 ChipProg-481 ChipProg-G41		
AE-P52-T5112-Z		DIP40/PLCC52 specialized adapter for Atmel microcontrollers with clam shell socket	ChipProg-40 ChipProg-48 ChipProg-481 ChipProg-G41		
AE-P52-T5131		DIP40/PLCC52 specialized adapter for Atmel microcontrollers with open top socket	ChipProg-40 ChipProg-48 ChipProg-481 ChipProg-G41		

AE-P52-T5131-Z		DIP40/PLCC52 specialized adapter for Atmel microcontrollers with clam shell socket	ChipProg-40 ChipProg-48 ChipProg-481 ChipProg-G41		
AE-P52-T51CC03		DIP40/PLCC52 specialized adapter for Atmel microcontrollers with open top socket	ChipProg-40 ChipProg-48 ChipProg-481 ChipProg-G41		
AE-P52-T51CC03-Z		DIP40/PLCC52 specialized adapter for Atmel microcontrollers with clam shell socket	ChipProg-40 ChipProg-48 ChipProg-481 ChipProg-G41		
AE-P68-i51GB		DIP40/PLCC68 specialized adapter for Intel microcontrollers with open top socket	ChipProg-40 ChipProg-48 ChipProg-481 ChipProg-G41		
AE-P68-i51GB-Z		DIP40/PLCC68 specialized adapter for Intel microcontrollers with clam shell socket	ChipProg-40 ChipProg-48 ChipProg-481 ChipProg-G41		
AE-P68-ph552		DIP40/PLCC68 specialized adapter for Philips/NXP microcontrollers with open top socket	ChipProg-40 ChipProg-48 ChipProg-481 ChipProg-G41		
AE-P68-ph552-Z		DIP40/PLCC68 specialized adapter for Philips/NXP microcontrollers with clam shell socket	ChipProg-40 ChipProg-48 ChipProg-481 ChipProg-G41		
AE-P68-T51		DIP40/PLCC68 specialized adapter for Atmel microcontrollers with open top socket	ChipProg-40 ChipProg-48 ChipProg-481 ChipProg-G41		
AE-P68-T51-Z		DIP40/PLCC68 specialized adapter for Atmel microcontrollers with clam shell socket	ChipProg-40 ChipProg-48 ChipProg-481 ChipProg-G41		
AE-P68-W79		DIP40/PLCC68 specialized adapter for Nuvoton/Winbond microcontrollers with open top socket	ChipProg-40 ChipProg-48 ChipProg-481 ChipProg-G41		
AE-P68-W79-Z		DIP40/PLCC68 specialized adapter for Nuvoton/Winbond microcontrollers with clam shell socket	ChipProg-40 ChipProg-48 ChipProg-481 ChipProg-G41		
AE-Q100-CY8C38		DIP40/QFP100 specialized adapter for Cypress microcontrollers	ChipProg-48 ChipProg-481 ChipProg-G41		
AE-Q100-SILAB		DIP40/QFP100 specialized adapter for Silabs/Cygnal microcontrollers	ChipProg-48 ChipProg-481 ChipProg-G41		

AE-Q100-W217		DIP40/PQFP100 specialized adapter for Nuvoton/Winbond microcontrollers	ChipProg-40 ChipProg-48 ChipProg-481 ChipProg-G41		
AE-Q44-LP6440		DIP40/QFP44 specialized adapter for 8051 devices	ChipProg-40 ChipProg-48 ChipProg-481 ChipProg-G41		
AE-Q44-P952		DIP40/QFP44 specialized adapter for Philips/NXP devices	ChipProg-40 ChipProg-48 ChipProg-481 ChipProg-G41		
AE-Q44-W79		DIP40/QFP44 specialized adapter for Nuvoton/Winbond microcontrollers	ChipProg-40 ChipProg-48 ChipProg-481 ChipProg-G41		
AE-Q48-i51		DIP40/QFP48 specialized adapter for 8051 microcontrollers	ChipProg-40 ChipProg-48 ChipProg-481 ChipProg-G41		
AE-Q48-W79		DIP40/QFP48 specialized adapter for Nuvoton/Winbond microcontrollers	ChipProg-40 ChipProg-48 ChipProg-481 ChipProg-G41		
AE-Q48-W79-2		DIP40/QFP48 specialized adapter for Nuvoton/Winbond microcontrollers	ChipProg-40 ChipProg-48 ChipProg-481 ChipProg-G41		
AE-Q48-W79-3		DIP40/QFP48 specialized adapter for Nuvoton/Winbond microcontrollers	ChipProg-40 ChipProg-48 ChipProg-481 ChipProg-G41		
AE-Q48-W79-4		DIP40/QFP48 specialized adapter for Nuvoton/Winbond microcontrollers	ChipProg-40 ChipProg-48 ChipProg-481 ChipProg-G41		
AE-Q64-CC03		DIP40/QFP64 specialized adapter for Atmel microcontrollers	ChipProg-40 ChipProg-48 ChipProg-481 ChipProg-G41		
AE-Q64-MAX51		DIP40/QFP64 specialized adapter for Maxim microcontrollers	ChipProg-48 ChipProg-481 ChipProg-G41		
AE-Q64-ph554		DIP40/QFP64 specialized adapter for Philips/NXP microcontrollers	ChipProg-40 ChipProg-48 ChipProg-481 ChipProg-G41		
AE-Q64-SILAB		DIP40/QFP64 specialized adapter for Silabs/Cygnal microcontrollers	ChipProg-48 ChipProg-481 ChipProg-G41		

AE-Q64-T51		DIP40/QFP64 specialized adapter for Atmel microcontrollers	ChipProg-40 ChipProg-48 ChipProg-481 ChipProg-G41		
AE-Q64-T5131		DIP40/QFP64 specialized adapter for Atmel microcontrollers	ChipProg-40 ChipProg-48 ChipProg-481 ChipProg-G41		
AE-Q80-T5132		DIP40/QFP80 specialized adapter for Atmel microcontrollers	ChipProg-48 ChipProg-481 ChipProg-G41		
AE-QFN32-T5131		DIP40/QFN32 specialized adapter for Atmel microcontrollers with clam shell socket	ChipProg-40 ChipProg-48 ChipProg-481 ChipProg-G41		
AE-QFN32U2-T		DIP32/QFN32 universal adapter with open top socket	ChipProg-40 ChipProg-48 ChipProg-481 ChipProg-G41		
AE-QFN40T-CC25		DIP42/QFN40 specialized adapter for TI/Chipcon microcontrollers CC253x/CC2540/41	ChipProg-48 ChipProg-481 ChipProg-G41		
AE-QFN44-i51		DIP40/QFN44 specialized adapter for 8051 family microcontrollers	ChipProg-40 ChipProg-48 ChipProg-481 ChipProg-G41		
AE-QFN68-CY8C38		DIP40/QFN68 specialized adapter for Microchip PIC microcontrollers	ChipProg-48 ChipProg-481 ChipProg-G41		
AE-SD52-SDA		DIP40/SDIP56 specialized adapter	ChipProg-48 ChipProg-481 ChipProg-G41		
AE-SP20-PCF7941		DIP20/TSSOP20 specialized adapter for Phillips/NXP PCF7941 microcontroller	ChipProg-48 ChipProg-481 ChipProg-G41		
AE-SP28-PCF7953		DIP28/TSSOP28 specialized adapter for Phillips/NXP PCF7953 microcontroller	ChipProg-48 ChipProg-481 ChipProg-G41		
AE-T44-i51		DIP40/QFP44 specialized adapter for microcontrollers	ChipProg-40 ChipProg-48 ChipProg-481 ChipProg-G41		
AE-T44-i51/505		DIP40/QFP44 specialized adapter for microcontrollers	ChipProg-40 ChipProg-48 ChipProg-481 ChipProg-G41		

AE-T44-
T51CC



DIP40/QFP44 specialized adapter for
Atmel devices

ChipProg-40
ChipProg-48
ChipProg-481
ChipProg-G41

Минск тел. +375447584780 minsk17@tut.by www.fotorele.net

80196 MICROCONTROLLERS

**PART
NUMBER**

IMAGE

DESCRIPTION

DEVICE LISTS

AE-P52-
i196JQ



DIP40/PLCC52 specialized adapter for
Intel microcontrollers with open top
socket,

ChipProg-40
ChipProg-48
ChipProg-481
ChipProg-G41

AE-P52-
i196JQ-Z



DIP40/PLCC52 specialized adapter for
Intel microcontrollers with clam shell
socket,

ChipProg-40
ChipProg-48
ChipProg-481
ChipProg-G41

AE-P68-
i196CA



DIP40/PLCC68 specialized adapter for
Intel microcontrollers with open top
socket

ChipProg-40
ChipProg-48
ChipProg-481
ChipProg-G41

AE-P68-
i196CA-Z



DIP40/PLCC68 specialized adapter for
Intel microcontrollers with clam shell
socket

ChipProg-40
ChipProg-48
ChipProg-481
ChipProg-G41

AE-P68-
i196KD

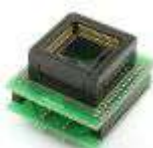

DIP40/PLCC68 specialized adapter for
Intel microcontrollers with open top
socket

ChipProg-40
ChipProg-48
ChipProg-481
ChipProg-G41

AE-P68-
i196KD-Z



DIP40/PLCC68 specialized adapter for
Intel microcontrollers with clam shell
socket

ChipProg-40
ChipProg-48
ChipProg-481
ChipProg-G41

AE-P68-
i196KR

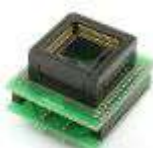

DIP40/PLCC68 specialized adapter for
Intel microcontrollers with open top socket

ChipProg-40
ChipProg-48
ChipProg-481
ChipProg-G41

AE-P68-
i196KR-Z



DIP40/PLCC68 specialized adapter for
Intel microcontrollers with clam shell
socket

ChipProg-40
ChipProg-48
ChipProg-481
ChipProg-G41

AE-P68-
i196NT



DIP40/PLCC68 specialized adapter for
Intel microcontrollers with open top
socket

ChipProg-40
ChipProg-48
ChipProg-481
ChipProg-G41

AE-P68-
i196NT-Z



DIP40/PLCC68 specialized adapter for
Intel microcontrollers with clam shell
socket

ChipProg-40
ChipProg-48
ChipProg-481
ChipProg-G41

AE-P84-
i196CB



DIP40/PLCC84 specialized adapter for
Intel devices with open top socket

ChipProg-40
ChipProg-48
ChipProg-481
ChipProg-G41

AE-P84-
i196CB-Z



DIP40/PLCC84 specialized adapter for Intel devices with clam shell socket

ChipProg-40
ChipProg-48
ChipProg-481
ChipProg-G41

AE-P84-
i196MC

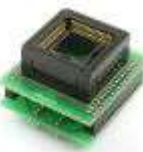

DIP40/PLCC84 specialized adapter for Intel devices with open top socket

ChipProg-40
ChipProg-48
ChipProg-481
ChipProg-G41

AE-P84-
i196MC-Z



DIP40/PLCC84 specialized adapter for Intel devices with clam shell socket

ChipProg-40
ChipProg-48
ChipProg-481
ChipProg-G41

Минск тел. +375447584780 minsk17@tut.by www.fotorele.net

PIC MICROCONTROLLERS

**PART
NUMBER**

IMAGE

DESCRIPTION

DEVICE LISTS

AE-ML28-p16



DIP28/MLF28 specialized adapter for Microchip PIC microcontrollers in MLF/QFN packages

ChipProg-40
ChipProg-48
ChipProg-481
ChipProg-G41

AE-P44-p16



DIP40/PLCC44 specialized adapter for Microchip microcontrollers with open top socket

ChipProg-40
ChipProg-48
ChipProg-481
ChipProg-G41

AE-P44-p16-Z



DIP40/PLCC44 specialized adapter for Microchip microcontrollers with clam shell socket

ChipProg-40
ChipProg-48
ChipProg-481
ChipProg-G41

AE-P44-p17



DIP40/PLCC44 specialized adapter for Microchip microcontrollers with open top socket

ChipProg-40
ChipProg-48
ChipProg-481
ChipProg-G41

AE-P44-p17-Z



DIP40/PLCC44 specialized adapter for Microchip microcontrollers with clam shell socket

ChipProg-40
ChipProg-48
ChipProg-481
ChipProg-G41

AE-P68-p658

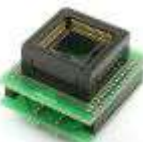

DIP40/PLCC68 specialized adapter for Microchip PIC microcontrollers with open top socket

ChipProg-40
ChipProg-48
ChipProg-481
ChipProg-G41

AE-P68-p658-
1

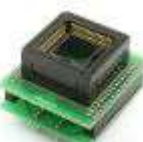

DIP40/PLCC68 specialized adapter for Microchip PIC microcontrollers with open top socket

ChipProg-40
ChipProg-48
ChipProg-481
ChipProg-G41

AE-P68-p658-
1-Z



DIP40/PLCC68 specialized adapter for Microchip PIC microcontrollers with clam shell socket

ChipProg-40
ChipProg-48
ChipProg-481
ChipProg-G41

AE-P68-p658-
Z



DIP40/PLCC68 specialized adapter for Microchip PIC microcontrollers with clam shell socket

ChipProg-40
ChipProg-48
ChipProg-481
ChipProg-G41





AE-P84-p858		DIP40/PLCC84 specialized adapter for Microchip PIC devices with open top socket	ChipProg-40 ChipProg-48 ChipProg-481 ChipProg-G41		
AE-P84-p858-Z		DIP40/PLCC84 specialized adapter for Microchip PIC devices with clam shell socket	ChipProg-40 ChipProg-48 ChipProg-481 ChipProg-G41		
AE-Q100-p33		DIP40/QFP100 specialized adapter for Microchip PIC microcontrllers	ChipProg-40 ChipProg-48 ChipProg-481 ChipProg-G41		
AE-Q100-p33-1		DIP40/QFP100 specialized adapter for Microchip PIC microcontrllers	ChipProg-40 ChipProg-48 ChipProg-481 ChipProg-G41		
AE-Q100-PIC32-1		DIP40/QFP100 specialized adapter for Microchip PIC microcontrllers	ChipProg-40 ChipProg-48 ChipProg-481 ChipProg-G41		
AE-Q100-PIC32-3		DIP40/QFP100 specialized adapter for Microchip PIC microcontrllers	ChipProg-40 ChipProg-48 ChipProg-481 ChipProg-G41		
AE-Q144-P33-1		DIP48/QFP144 specialized adapter for Microchip microcontrollers	ChipProg-40 ChipProg-48 ChipProg-481 ChipProg-G41		
AE-Q44-p33		DIP40/QFP44 specialized adapter for Microchip PIC devices	ChipProg-40 ChipProg-48 ChipProg-481 ChipProg-G41		
AE-Q44-p33GS		DIP40/QFP44 specialized adapter for Microchip PIC devices	ChipProg-40 ChipProg-48 ChipProg-481 ChipProg-G41		
AE-Q64-p33		DIP40/QFP64 specialized adapter for Microchip PIC microcontrollers	ChipProg-40 ChipProg-48 ChipProg-481 ChipProg-G41		
AE-Q64-p658		DIP40/QFP64 specialized adapter for Microchip PIC microcontrollers	ChipProg-40 ChipProg-48 ChipProg-481 ChipProg-G41		
AE-Q64-p946		DIP40/QFP64 specialized adapter for Microchip PIC microcontrollers	ChipProg-40 ChipProg-48 ChipProg-481 ChipProg-G41		
AE-Q64-PIC16F15		DIP40/QFP64 specialized adapter for Microchip PIC microcontrollers	ChipProg-40 ChipProg-48 ChipProg-481 ChipProg-G41		



AE-Q64-PIC30-1		DIP40/QFP64 specialized adapter for Microchip PIC microcontrollers	ChipProg-48 ChipProg-481 ChipProg-G41		
AE-Q64-PIC32		DIP40/QFP64 specialized adapter for Microchip PIC microcontrollers	ChipProg-40 ChipProg-48 ChipProg-481 ChipProg-G41		
AE-Q80-p33		DIP40/QFP80 specialized adapter for Microchip PIC microcontrollers	ChipProg-40 ChipProg-48 ChipProg-481 ChipProg-G41		
AE-Q80-p33-2		DIP40/QFP80 specialized adapter for Microchip PIC microcontrollers	ChipProg-40 ChipProg-48 ChipProg-481 ChipProg-G41		
AE-Q80-p858		DIP40/QFP80 specialized adapter for Microchip PIC microcontrollers	ChipProg-40 ChipProg-48 ChipProg-481 ChipProg-G41		
AE-Q80-PIC30-2		DIP40/QFP80 specialized adapter for Microchip PIC microcontrollers	ChipProg-48 ChipProg-481 ChipProg-G41		
AE-QFN16-p16		DIP14/QFN16 specialized adapter for Microchip microcontrollers in MLF/QFN packages	ChipProg-40 ChipProg-48 ChipProg-481 ChipProg-G41		
AE-QFN16-p16-2		DIP14/QFN16 specialized adapter for Microchip microcontrollers in QFN packages	ChipProg-40 ChipProg-48 ChipProg-481 ChipProg-G41		
AE-QFN20-p16		DIP20/QFN20 specialized adapter for Microchip microcontrollers in MLF/QFN packages	ChipProg-40 ChipProg-48 ChipProg-481 ChipProg-G41		
AE-QFN28-p16-2		DIP18/QFN28 specialized adapter for Microchip PIC microcontrollers in MLF/QFN packages	ChipProg-40 ChipProg-48 ChipProg-481 ChipProg-G41		
AE-QFN28-p16-3		DIP18/QFN28 specialized adapter for Microchip PIC microcontrollers in QFN packages	ChipProg-40 ChipProg-48 ChipProg-481 ChipProg-G41		
AE-QFN28-p16-4		DIP28/QFN28 specialized adapter for Microchip PIC microcontrollers in QFN packages	ChipProg-40 ChipProg-48 ChipProg-481 ChipProg-G41		
AE-QFN40-P18		DIP40/QFN40 specialized adapter for Microchip microcontrollers	ChipProg-40 ChipProg-48 ChipProg-481 ChipProg-G41		

AE-QFN44-p16		DIP40/QFN44 specialized adapter for Microchip PIC microcontrollers in MLF/QFN packages	ChipProg-40 ChipProg-48 ChipProg-481 ChipProg-G41		
AE-QFN44-p16-2		DIP40/QFN44 specialized adapter for Microchip PIC microcontrollers in MLF/QFN packages	ChipProg-40 ChipProg-48 ChipProg-481 ChipProg-G41		
AE-QFN44-p33		DIP40/QFN44 specialized adapter for Microchip PIC microcontrollers in QFN packages	ChipProg-40 ChipProg-48 ChipProg-481 ChipProg-G41		
AE-QFN44-p33GS		DIP40/QFN44 specialized adapter for Microchip PIC microcontrollers in QFN packages	ChipProg-40 ChipProg-48 ChipProg-481 ChipProg-G41		
AE-QFN48-P16		DIP40/QFN48 specialized adapter for Microchip PIC microcontrollers	ChipProg-40 ChipProg-48 ChipProg-481 ChipProg-G41		
AE-QFN64-P33		DIP40/QFN64 specialized adapter for Microchip PIC microcontrollers	ChipProg-40 ChipProg-48 ChipProg-481 ChipProg-G41		
AE-QFN64-PIC16F15		DIP40/QFN64 specialized adapter for Microchip PIC microcontrollers	ChipProg-40 ChipProg-48 ChipProg-481 ChipProg-G41		
AE-QFN64-PIC32		DIP40/QFN64 specialized adapter for Microchip PIC microcontrollers	ChipProg-40 ChipProg-48 ChipProg-481 ChipProg-G41		
AE-SOT23-p10		DIP8/SOT-23-6 specialized adapter for Microchip PIC	ChipProg-40 ChipProg-48 ChipProg-481 ChipProg-G41		
AE-SP20-p16		DIP18/SSOP20 specialized adapter for Microchip PIC	ChipProg-40 ChipProg-48 ChipProg-481 ChipProg-G41		
AE-SP28-p5x		DIP28/SSOP28 specialized adapter for Microchip PIC	ChipProg-40 ChipProg-48 ChipProg-481 ChipProg-G41		
AE-T44-p16		DIP40/QFP44 specialized adapter for Microchip PIC devices	ChipProg-40 ChipProg-48 ChipProg-481 ChipProg-G41		
AE-T44-p17		DIP40/QFP44 specialized adapter for Microchip PIC devices	ChipProg-40 ChipProg-48 ChipProg-481 ChipProg-G41		

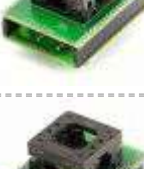
AVR MICROCONTROLLERS

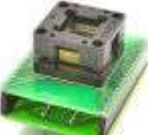

PART NUMBER	IMAGE	DESCRIPTION	DEVICE LISTS
AE-B49-XMEGA		DIP40/BGA49 specialized adapter for Atmel microcontrollers	ChipProg-40 ChipProg-48 ChipProg-481 ChipProg-G41
AE-P44-AT35		DIP40/PLCC44 specialized adapter for Atmel AVR devices with open top socket	ChipProg-40 ChipProg-48 ChipProg-481 ChipProg-G41
AE-P44-AT35-Z		DIP40/PLCC44 specialized adapter for Atmel AVR devices with clam shellsocket	ChipProg-40 ChipProg-48 ChipProg-481 ChipProg-G41
AE-P44-i51		DIP40/PLCC44 specialized adapter for microcontrollers with open top socket	ChipProg-40 ChipProg-48 ChipProg-481 ChipProg-G41
AE-P44-i51-Z		DIP40/PLCC44 specialized adapter for microcontrollers with clam shell socket	ChipProg-40 ChipProg-48 ChipProg-481 ChipProg-G41
AE-Q100-ATm1280		DIP40/QFP100 specialized adapter for Atmel AVR devices	ChipProg-40 ChipProg-48 ChipProg-481 ChipProg-G41
AE-Q100-XMEGA		DIP40/QFP100 specialized adapter for Atmel microcontrlers	ChipProg-40 ChipProg-48 ChipProg-481 ChipProg-G41
AE-Q32-AV1		DIP28/QFP32 specialized adapter for Atmel microcontrollers	ChipProg-40 ChipProg-48 ChipProg-481 ChipProg-G41
AE-Q44-AT32U4		DIP40/QFP44 specialized adapter for Atmel AVR devices (ATmega16U4/32U4)	ChipProg-40 ChipProg-48 ChipProg-481 ChipProg-G41
AE-Q44-XMEGA		DIP40/QFP48 specialized adapter for Atmel microcontrollers	ChipProg-40 ChipProg-48 ChipProg-481 ChipProg-G41
AE-Q64-ATm128		DIP40/QFP64 specialized adapter for Atmel AVR microcontrollers	ChipProg-40 ChipProg-48 ChipProg-481 ChipProg-G41
AE-Q64-XMEGA		DIP40/QFP64 specialized adapter for Atmel AVR microcontrollers	ChipProg-40 ChipProg-48 ChipProg-481 ChipProg-G41

AE-QFN20-AV1		DIP8/QFN20 specialized adapter for Atmel microcontrollers in MLF/QFN packages	ChipProg-40 ChipProg-48 ChipProg-481 ChipProg-G41		
AE-QFN20-AV2		DIP20/QFN20 specialized adapter for Atmel microcontrollers in MLF/QFN packages	ChipProg-40 ChipProg-48 ChipProg-481 ChipProg-G41		
AE-QFN32-AV1		DIP28/QFN32 specialized adapter for Atmel microcontrollers with clam shell socket	ChipProg-40 ChipProg-48 ChipProg-481 ChipProg-G41		
AE-QFN32-AV2		DIP32/QFN32 specialized adapter for Atmel microcontrollers with clam shell socket	ChipProg-48 ChipProg-481 ChipProg-G41		
AE-QFN32-AV3		DIP20/QFN32 specialized adapter for Atmel microcontrollers with clam shell socket	ChipProg-40 ChipProg-48 ChipProg-481 ChipProg-G41		
AE-QFN32-AV4		DIP24/QFN32 specialized adapter for Atmel microcontrollers with clam shell socket	ChipProg-48 ChipProg-481 ChipProg-G41		
AE-QFN32-AV5		DIP28/QFN32 specialized adapter for Atmel microcontrollers Xmega32e5 Device package dimensions: 6	ChipProg-40 ChipProg-48 ChipProg-481 ChipProg-G41		
AE-QFN44-AT32U4		DIP40/QFN44 specialized adapter for Atmel AVR microcontrollers	ChipProg-40 ChipProg-48 ChipProg-481 ChipProg-G41		
AE-QFN44-AT35		DIP40/QFN44 specialized adapter for Atmel AVR microcontrollers	ChipProg-40 ChipProg-48 ChipProg-481 ChipProg-G41		
AE-QFN44-XMEGA		DIP40/QFN44 specialized adapter for Atmel AVR microcontrollers	ChipProg-40 ChipProg-48 ChipProg-481 ChipProg-G41		
AE-QFN48-ATM128RF		DIP40/QFN48 specialized adapter for Atmel microcontrollers	ChipProg-40 ChipProg-48 ChipProg-481 ChipProg-G41		
AE-QFN64-ATM128		DIP40/QFN64 specialized adapter for Atmel microcontrollers	ChipProg-40 ChipProg-48 ChipProg-481 ChipProg-G41		
AE-QFN64-ATM128RF		DIP40/QFN64 specialized adapter for Atmel microcontrollers	ChipProg-40 ChipProg-48 ChipProg-481 ChipProg-G41		

AE-QFN64-XMEGA		DIP40/QFN64 specialized adapter for Atmel microcontrollers	ChipProg-40 ChipProg-48 ChipProg-481 ChipProg-G41
AE-T44-AT35		DIP40/QFP44 specialized adapter for Atmel AVR devices	ChipProg-40 ChipProg-48 ChipProg-481 ChipProg-G41
AE-T44-i51		DIP40/QFP44 specialized adapter for microcontrollers	ChipProg-40 ChipProg-48 ChipProg-481 ChipProg-G41
AE-T44-i51-505		DIP40/QFP44 specialized adapter for microcontrollers	ChipProg-40 ChipProg-48 ChipProg-481 ChipProg-G41

Минск тел. +375447584780 minsk17@tut.by www.fotorele.net

MSP430 MICROCONTROLLERS

PART NUMBER	IMAGE	DESCRIPTION	DEVICE LISTS
AE-Q100-MSP430		DIP40/QFP100 specialized adapter for TI microcontrollers	ChipProg-48 ChipProg-481 ChipProg-G41
AE-Q100-MSP430-2		DIP40/QFP100 specialized adapter for TI microcontrollers	ChipProg-48 ChipProg-481 ChipProg-G41
AE-Q64-MSP430		DIP40/QFP64 specialized adapter for TI MSP430Fxxx microcontrollers	ChipProg-48 ChipProg-481 ChipProg-G41
AE-Q64-MSP430-3		DIP40/QFP64 specialized adapter for TI MSP430Fxxx microcontrollers	ChipProg-48 ChipProg-481 ChipProg-G41
AE-Q80-MSP430		DIP40/QFP80 specialized adapter for TI microcontrollers	ChipProg-48 ChipProg-481 ChipProg-G41
AE-Q80-MSP430-2		DIP40/QFP80 specialized adapter for TI microcontrollers	ChipProg-48 ChipProg-481 ChipProg-G41
AE-QFN64-MSP430		DIP40/QFN64 specialized adapter for TI MSP430 microcontrollers	ChipProg-48 ChipProg-481 ChipProg-G41
AE-QFN64-MSP430-2		DIP40/QFN64 specialized adapter for TI MSP430 microcontrollers	ChipProg-48 ChipProg-481 ChipProg-G41

HC S08 AND HC S12 MICROCONTROLLERS

PART NUMBER	IMAGE	DESCRIPTION	DEVICE LISTS		
AE-Q100-HCS12		DIP40/QFP100 specialized adapter for Motorola/Freescale MC9S12xxx devices	ChipProg-48 ChipProg-481 ChipProg-G41		
AE-Q100-HCS12-2		DIP42/QFP100 specialized adapter for Motorola/Freescale MC9S12xxx devices	ChipProg-48 ChipProg-481 ChipProg-G41		
AE-Q112-HCS12		DIP48/QFP112 specialized adapter for Motorola/Freescale MC9S12xxx devices	ChipProg-48 ChipProg-481 ChipProg-G41		
AE-Q144-HCS12		DIP48/QFP144 specialized adapter for Motorola/Freescale MC9S12xxx devices	ChipProg-48 ChipProg-481 ChipProg-G41		
AE-Q48-HCS12		DIP48/QFP48 specialized adapter for Motorola/Freescale microcontrollers	ChipProg-48 ChipProg-481 ChipProg-G41		
AE-Q52-HCS12		DIP40/QFP52 specialized adapter for Motorola/Freescale microcontrollers	ChipProg-48 ChipProg-481 ChipProg-G41		
AE-Q64-HCS08-1		DIP40/QFP64 specialized adapter for Motorola/Freescale microcontrollers	ChipProg-48 ChipProg-481 ChipProg-G41		
AE-Q64-HCS08-2		DIP40/QFP64 specialized adapter for Motorola/Freescale microcontrollers	ChipProg-48 ChipProg-481 ChipProg-G41		
AE-Q64-HCS08-3		DIP40/QFP64 specialized adapter for Motorola/Freescale microcontrollers	ChipProg-48 ChipProg-481 ChipProg-G41		
AE-Q64-HCS12		DIP40/QFP64 specialized adapter for Motorola/Freescale microcontrollers	ChipProg-48 ChipProg-481 ChipProg-G41		
AE-Q80-HCS08		DIP40/QFP80 specialized adapter for Motorola/Freescale microcontrollers	ChipProg-48 ChipProg-481 ChipProg-G41		
AE-Q80-HCS08-2		DIP40/QFP80 specialized adapter for Motorola/Freescale microcontrollers	ChipProg-48 ChipProg-481 ChipProg-G41		

AE-Q80-
HCS12-1DIP48/QFP80 specialized adapter for
Motorola/Freescale microcontrollersChipProg-48
ChipProg-481
ChipProg-G41AE-Q80-
HCS12-2DIP48/QFP80 specialized adapter for
Motorola/Freescale microcontrollersChipProg-48
ChipProg-481
ChipProg-G41

Минск тел. +375447584780 minsk17@tut.by www.fotorele.net

ST7 AND STM8 MICROCONTROLLERS**PART
NUMBER****IMAGE****DESCRIPTION****DEVICE LISTS**

AE-Q32-STM8

DIP32/QFP32 specialized adapter for
STMicro STM8 vmicrocontrollersChipProg-40
ChipProg-48
ChipProg-481
ChipProg-G41AE-Q32-
STM8-2DIP32/QFP32 specialized adapter for
STMicro STM8 vmicrocontrollersChipProg-40
ChipProg-48
ChipProg-481
ChipProg-G41

AE-Q44-STM8







DIP40/QFP44 specialized adapter for
STMicro STM8 vmicrocontrollersChipProg-40
ChipProg-48
ChipProg-481
ChipProg-G41

AE-Q48-STM8

DIP40/QFP48 specialized adapter for
STMicro STM8 microcontrollersChipProg-40
ChipProg-48
ChipProg-481
ChipProg-G41AE-Q48-
STM8-2DIP40/QFP48 specialized adapter for
STMicro STM8 microcontrollersChipProg-40
ChipProg-48
ChipProg-481
ChipProg-G41AE-Q64-ST7-
1DIP40/QFP64 specialized adapter for
STMicro ST7 vmicrocontrollersChipProg-48
ChipProg-481
ChipProg-G41AE-Q64-ST7-
2DIP40/QFP64 specialized adapter for
STMicro ST7 vmicrocontrollersChipProg-48
ChipProg-481
ChipProg-G41





AE-Q64-STM8

DIP40/QFP64 specialized adapter for
STMicro STM8 microcontrollersChipProg-40
ChipProg-48
ChipProg-481
ChipProg-G41AE-Q64-
STM8-2DIP40/QFP64 specialized adapter for
STMicro STM8 microcontrollersChipProg-40
ChipProg-48
ChipProg-481
ChipProg-G41AE-Q64-
STM8-3DIP40/QFP64 specialized adapter for
STMicro STM8 microcontrollersChipProg-40
ChipProg-48
ChipProg-481
ChipProg-G41

AE-Q80-STM8		DIP40/QFP80 specialized adapter for STMicro STM8 microcontrollers	ChipProg-40 ChipProg-48 ChipProg-481 ChipProg-G41		
AE-Q80-STM8-2		DIP40/QFP80 specialized adapter for STMicro STM8 microcontrollers	ChipProg-40 ChipProg-48 ChipProg-481 ChipProg-G41		
AE-QFN32-STM8		DIP32/QFN32 specialized adapter for STMicro STM8 microcontrollers	ChipProg-40 ChipProg-48 ChipProg-481 ChipProg-G41		
AE-QFN32-STM8-2		DIP32/QFN32 specialized adapter for STMicro STM8 microcontrollers	ChipProg-40 ChipProg-48 ChipProg-481 ChipProg-G41		
AE-QFN48-STM8-2		DIP40/QFN48 specialized adapter for STMicro STM8 microcontrollers	ChipProg-40 ChipProg-48 ChipProg-481 ChipProg-G41		
AE-SC20-STM8		DIP28/SOIC20 specialized adapter for STMicroelectronics STM8 family	ChipProg-40 ChipProg-48 ChipProg-481 ChipProg-G41		
AE-SP20-STM8		DIP28/TSSOP20 specialized adapter for STMicroelectronics STM8 family	ChipProg-40 ChipProg-48 ChipProg-481 ChipProg-G41		

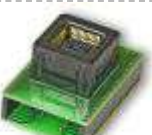
Минск тел. +375447584780 minsk17@tut.by www.fotorele.net

OTHER MICROCONTROLLERS



PART NUMBER	IMAGE	DESCRIPTION	DEVICE LISTS		
AE-P52-HC908		DIP40/PLCC52 specialized adapter for Motorola/Freescale microcontrollers with open top socket	ChipProg-48 ChipProg-481 ChipProg-G41		
AE-P52-HC908-Z		DIP40/PLCC52 specialized adapter for Motorola/Freescale microcontrollers with clam shell socket	ChipProg-48 ChipProg-481 ChipProg-G41		
AE-Q100-FT900		DIP40/QFP100 specialized adapter for FTDI Chip FT90xL devices	ChipProg-48 ChipProg-481 ChipProg-G41		
AE-Q100-NEC-1		DIP40/QFP100 specialized adapter for NEC microcontrollers	ChipProg-48 ChipProg-481 ChipProg-G41		
AE-Q100-PSOC1		DIP40/QFP100 specialized adapter for Cypress microcontrllers	ChipProg-48 ChipProg-481 ChipProg-G41		

AE-Q100-RL78-1		DIP40/QFP100 specialized adapter for Renesas (RL78 family) microcontrllers	ChipProg-48 ChipProg-481 ChipProg-G41		
AE-Q100-RL78-2		DIP40/QFP100 specialized adapter for Renesas (RL78 Family) microcontrllers	ChipProg-48 ChipProg-481 ChipProg-G41		
AE-Q100-RSC		DIP40/QFP100 specialized adapter for Sensory microcontrllers	ChipProg-40 ChipProg-48 ChipProg-481 ChipProg-G41		
AE-Q100-RX600		DIP40/QFP100 specialized adapter for Renesas RX200 and RX600 microcontrllers in serial mode	ChipProg-48 ChipProg-481 ChipProg-G41		
AE-Q100Q-M16		DIP40/QFP100 specialized adapter for Renesas (Mitsubishi) microcontrllers	ChipProg-40 ChipProg-48 ChipProg-481 ChipProg-G41		
AE-Q100S-M16		DIP40/QFP100 specialized adapter for Renesas (Mitsubishi) microcontrllers	ChipProg-40 ChipProg-48 ChipProg-481 ChipProg-G41		
AE-Q144-RX600		DIP40/QFP80 specialized adapter for Renesas RX200 and RX600 microcontrllers in serial mode	ChipProg-48 ChipProg-481 ChipProg-G41		
AE-Q176-SST79		DIP40/QFP176 specialized adapter for SST microcontrollers	ChipProg-48 ChipProg-481 ChipProg-G41		
AE-Q32-XE03		DIP40/QFP32 specialized adapter for Semtech/Xemics microcontrollers	ChipProg-48 ChipProg-481 ChipProg-G41		
AE-Q44-PSOC1		DIP40/QFP44 specialized adapter for Cypress microcontrollers	ChipProg-48 ChipProg-481 ChipProg-G41		
AE-Q44-XE01		DIP40/QFP44 specialized adapter for Semtech/Xemics devices	ChipProg-48 ChipProg-481 ChipProg-G41		
AE-Q48-F387		DIP40/QFP48 specialized adapter for Fujitsu microcontrollers	ChipProg-40		
AE-Q48-XC800		DIP40/QFP48 specialized adapter for Infineon microcontrollers	ChipProg-40 ChipProg-48 ChipProg-481 ChipProg-G41		

AE-Q52-RL78		DIP40/QFP52 specialized adapter for Renesas microcontrollers	ChipProg-48 ChipProg-481 ChipProg-G41		
AE-Q64-HC908-2		DIP40/QFP64 specialized adapter for Motorola/Freescale microcontrollers	ChipProg-48 ChipProg-481 ChipProg-G41		
AE-Q64-HC908-LD/MR		DIP40/QFP64 specialized adapter for Motorola/Freescale microcontrollers	ChipProg-48 ChipProg-481 ChipProg-G41		
AE-Q64-NEC-1		DIP40/QFP64 specialized adapter for NEC microcontrollers	ChipProg-48 ChipProg-481 ChipProg-G41		
AE-Q64-NEC-2		DIP40/QFP64 specialized adapter for NEC microcontrollers	ChipProg-48 ChipProg-481 ChipProg-G41		
AE-Q64-NEC-3		DIP40/QFP64 specialized adapter for NEC microcontrollers	ChipProg-48 ChipProg-481 ChipProg-G41		
AE-Q64-NEC-4		DIP40/QFP64 specialized adapter for NEC microcontrollers	ChipProg-48 ChipProg-481 ChipProg-G41		
AE-Q64-RL78-1		DIP40/QFP64 specialized adapter for Renesas microcontrollers	ChipProg-48 ChipProg-481 ChipProg-G41		
AE-Q64-RL78-2		DIP40/QFP64 specialized adapter for Renesas microcontrollers	ChipProg-48 ChipProg-481 ChipProg-G41		
AE-Q64-RL78-3		DIP40/QFP64 specialized adapter for Renesas microcontrollers	ChipProg-48 ChipProg-481 ChipProg-G41		
AE-Q64-RL78-4		DIP40/QFP64 specialized adapter for Renesas microcontrollers	ChipProg-48 ChipProg-481 ChipProg-G41		
AE-Q64-RL78-5		DIP40/QFP64 specialized adapter for Renesas microcontrollers	ChipProg-48 ChipProg-481 ChipProg-G41		
AE-Q64-RX600-1		DIP40/QFP64 specialized adapter for Renesas RX200 and RX600 microcontrollers in serial mode	ChipProg-48 ChipProg-481 ChipProg-G41		











AE-Q64-RX600-2			ChipProg-48 ChipProg-481 ChipProg-G41		
AE-Q64-XC800		DIP40/QFP64 specialized adapter for Infineon microcontrollers	ChipProg-40 ChipProg-48 ChipProg-481 ChipProg-G41		
AE-Q64-XE05		DIP40/QFP64 specialized adapter for Semtech/Xemics microcontrollers	ChipProg-48 ChipProg-481 ChipProg-G41		
AE-Q80-NEC-1		DIP40/QFP80 specialized adapter for NEC microcontrollers	ChipProg-48 ChipProg-481 ChipProg-G41		
AE-Q80-NEC-2		DIP40/QFP80 specialized adapter for NEC microcontrollers	ChipProg-48 ChipProg-481 ChipProg-G41		
AE-Q80-RL78-1		DIP40/QFP80 specialized adapter for Renesas microcontrollers	ChipProg-48 ChipProg-481 ChipProg-G41		
AE-Q80-RL78-2		DIP40/QFP80 specialized adapter for Renesas microcontrollers	ChipProg-48 ChipProg-481 ChipProg-G41		
AE-Q80-RL78-3		DIP40/QFP80 specialized adapter for Renesas microcontrollers	ChipProg-48 ChipProg-481 ChipProg-G41		
AE-Q80-RL78-4		DIP40/QFP80 specialized adapter for Renesas microcontrollers	ChipProg-48 ChipProg-481 ChipProg-G41		
AE-Q80-RX600-1		DIP40/QFP80 specialized adapter for Renesas RX200 and RX600 microcontrollers in serial mode	ChipProg-48 ChipProg-481 ChipProg-G41		
AE-Q80-RX600-2		DIP40/QFP80 specialized adapter for Renesas RX200 and RX600 microcontrollers in serial mode	ChipProg-48 ChipProg-481 ChipProg-G41		
AE-QFN24-SR231		DIP24/QFN24 specialized adapter with open top socket for Syntronix SR2P231F microcontroller	ChipProg-48 ChipProg-481 ChipProg-G41		
AE-QFN32U2-T		DIP32/QFN32 universal adapter with open top socket	ChipProg-40 ChipProg-48 ChipProg-481 ChipProg-G41		



AE-QFN40-JN516		DIP42/QFN40 specialized adapter for NXP Jennic JN 516x microcontrollers	ChipProg-48 ChipProg-481 ChipProg-G41		
AE-QFN40-SR131		DIP40/QFN40 specialized adapter with open top socket for Syntronix SR2P131F microcontroller	ChipProg-48 ChipProg-481 ChipProg-G41		
AE-QFN48-PSOC1		DIP40/QFN48 specialized adapter for Cypress PSOC1 microcontrollers	ChipProg-48 ChipProg-481 ChipProg-G41		
AE-QFN48-SIS92		DIP40/QFN48 specialized adapter for SiS microcontrollers	ChipProg-48 ChipProg-481 ChipProg-G41		
AE-QFN64-RL78-1		DIP40/QFN64 specialized adapter for Renesas microcontrollers	ChipProg-48 ChipProg-481 ChipProg-G41		
AE-QFN64-SIS92		DIP40/QFN64 specialized adapter for SiS microcontrollers	ChipProg-48 ChipProg-481 ChipProg-G41		
AE-QFN68-PSOC1		DIP40/QFN68 specialized adapter for Cypress microcontrollers	ChipProg-48 ChipProg-481 ChipProg-G41		
AE-QFN68-SIS92		DIP40/QFN68 specialized adapter for SiS microcontrollers	ChipProg-48 ChipProg-481 ChipProg-G41		
AE-QFN88-SIS92		DIP40/QFN88 specialized adapter for SiS microcontrollers	ChipProg-48 ChipProg-481 ChipProg-G41		
AE-QFN88-SIS9250		DIP40/QFN88 specialized adapter for SiS microcontrollers	ChipProg-48 ChipProg-481 ChipProg-G41		
AE-SC16-ADAM2X		DIP16/SOIC16 specialized adapter for ADAM2X	ChipProg-48 ChipProg-481 ChipProg-G41		
AE-SC20-ADAM2X		DIP28/SOIC28 specialized adapter for ADAM2X	ChipProg-48 ChipProg-481 ChipProg-G41		
AE-SP20-ADAM2X		DIP28/SOIC28 specialized adapter for ADAM2X	ChipProg-48 ChipProg-481 ChipProg-G41		

AE-SP28-SR135		DIP28/TSSOP28 specialized adapter for Syntronix	ChipProg-48 ChipProg-481 ChipProg-G41
AE-SS48-PSOC1		DIP40/SSOP48 adapter for microcontrollers Cypress PSoC1	ChipProg-48 ChipProg-481 ChipProg-G41

Минск тел. +375447584780 minsk17@tut.by www.fotorele.net

IN-SYSTEM PROGRAMMING ADAPTERS TO BE USED WITH PARALLEL DEVICE PROGRAMMERS

PART NUMBER	IMAGE	DESCRIPTION	DEVICE LISTS
AE-ISP-ARM-2		DIP28/BH20 and BH10 specialized adapter for in system programming of ARM/Cortex microcontrollers	ChipProg-40 ChipProg-48 ChipProg-481 ChipProg-G41
AE-ISP-MC908		DIP28/BH-16 universal adapter for in system programming Motorola/Freescale microcontrollers	ChipProg-48 ChipProg-481 ChipProg-G41
AE-ISP-MSP430		DIP28/BH16 specialized adapter for in system programming of TI MSP430 microcontrollers in JTAG modes	ChipProg-40 ChipProg-48 ChipProg-481 ChipProg-G41
AE-ISP-MSP430-2		DIP28/BH16 specialized adapter for in system programming of TI MSP430 microcontrollers in JTAG modes	ChipProg-40 ChipProg-48 ChipProg-481 ChipProg-G41
AE-ISP-NEC		DIP28/BH16 specialized adapter for in system programming of NEC microcontrollers	ChipProg-48 ChipProg-481 ChipProg-G41
AE-ISP-PIC32		DIP28/BH14 specialized adapter for in system programming of Microchip PIC32 microcontrollers	ChipProg-40 ChipProg-48 ChipProg-481 ChipProg-G41
AE-ISP-RL78		DIP28/BH14 specialized adapter for in system programming of Renesas RL78 microcontrollers	ChipProg-48 ChipProg-481 ChipProg-G41
AE-ISP-RX			ChipProg-48 ChipProg-481 ChipProg-G41
AE-ISP-ST7		DIP28/BH10 specialized adapter for in system programming of ST7 and STM8 microcontrollers	ChipProg-40 ChipProg-48 ChipProg-481 ChipProg-G41
AE-ISP-U1		DIP28/BH-10 universal adapter for in system programming	ChipProg-40 ChipProg-48 ChipProg-481 ChipProg-G41

AE-ISP-U2		DIP28/BH10 universal adapter for in system programming	ChipProg-40 ChipProg-48 ChipProg-481 ChipProg-G41		
AE-ISP-U3		DIP28/BH10 universal adapter for in system programming	ChipProg-48 ChipProg-481 ChipProg-G41		
AE-SP20-PCF7961		DIP20/TSSOP20 specialized adapter for Phillips/NXP PCF7961 microcontroller	ChipProg-48 ChipProg-481 ChipProg-G41		

ACE Technology Energy Micro Lattice Samsung
Actrans EON Luminary Micro SANYO
Adesto ESMT Macronix SEEQ
AKM ETA CHIPS Marvell Seiko
ALI Evatronix MAXIM Semtech
Altera EVERSPIN MEGAWIN Sensory
AMD Excel Semiconductor Microchip SHARP
AMIC Exel Micron Siemens
Anachip Fairchild Micronas Signetics
Analog Devices Forward Milandr Silicon Labs
Angstrom Freescale MIRA SiS
Aplus Flash Technology Fremont Mitsubishi Spansion
Artschip FTDI Mosel-Vitellic SST
ASD Fudan Mostek STMicroelectronics
ATC Fujitsu Motorola SUMMIT
Atmel Gatelevel National Semiconductor SyncMOS
Belling Generalplus NEC Syntronix
Benchmark Giantec NIIET Tests
BJX GigaDevice Nordic Texas Instruments
BMT Green Engine Numonyx TOPRO
Bookly Micro Greenliant Nuvoton Toshiba
Boya Microelectronics Greenwich NVM Unknown
CAST Hitachi NXP Vantis
Catalyst Holtek Oki VLSI
Ceramate Hopefind ON Semiconductor Weltrend
Chingis Hynix Philips Winbond
Chipswinner IC Microsystems PMC XEMICS
Coreriver ICT RAMTRON Xicor
Cygnal IK Semiconductor Renesas Xilinx
Cypress Infineon Ricoh ZDEC
Dallas Semiconductor Integral Rockwell Zentel
E-CMOS Intel ROHM Zilog
ELM Technology ISSI Russia
ELMOS ITT Russia-NIIET
Ember Jennic Saifun

Программаторы, адаптеры, переходники, Минск, тел.+375447584780

www.fotorele.net www.tiristor.by радиодетали, электронные компоненты
email minsk17@tut.by tel.+375 29 758 47 80 МТС

[как купить- ON LINE Заказ](#)