



Электронные компоненты, радиодетали

где и как купить в Минске?

Категория: **ТИАНВО, РЕЛЕ**

hjq-22f-12vdc-2z 5a	электромагнитные реле
hjq-22f-240vac-2z 5a	электромагнитные реле
hjq-22f-240vac-2z 5a	электромагнитные реле
hjq-22f-24vdc-4z 5a	электромагнитные реле
hjq-22f-24vdc-4z 5a	электромагнитные реле
hjq-22f-24d -24в	бг без упаковки без паспорта н.уп.:
hjq-22f-3z ~24в	н.уп.:
hjq-22f-4z coil ac-220в 5a 240 vac 5f 28 vdc, импорт	н.уп.:
hjq-22f-4z coilac -24в 5a 240 vac 5a 28vdc, импорт	н.уп.:
hjq-22f-12vdc-2z 5a	реле
hjq-22f-12vdc-3z 5a	реле
hjq-22f-240vac-2z 5a	реле
hjq-22f-240vac-3z 5a	реле
hjq-22f-240vac-3zp 5a	реле
hjq-22f-24vac-2z 5a	реле
hjq-22f-24vac-3z 5a	реле
hjq-22f-24vdc-2z 5a	реле
hjq-22f-24vdc-3z 5a	реле

hjq-22f-24vdc-3z 5a реле
hjq-22f-24vdc-4z 5a реле
hjq-22f-3z 220v~
hjq-22f-240vac-2z-5a tianbo, / м.опт: 2-2 шт. опт: от 3 шт.
hjq-22f-24vdc-2z-5a tianbo, / м.опт: 5-29 шт. опт: от 30 шт.
hjq-22f-24vdc-3z-5a tianbo
hjq-22f-3z-24vdc tianbo, / м.опт: от 2 шт.
hjq-22f-4z-110vac tianbo
hjq-22f-4z-220vac tianbo, / м.опт: от 2 шт.
hjq-22f-4z-24vac tianbo, / м.опт: 2-4 шт. опт: от 5 шт.
hjq-22f-240vac-2z 5a реле no trademark, hjq-22f-240vac-2z 5a реле
hjq-22f-24vdc-4z 5a реле no trademark, hjq-22f-24vdc-4z 5a реле
hjq-22f-3z 24vdc 3п реле no trademark, hjq-22f-3z 24vdc 3п реле
hjq-22f- 12vdc-5a-конт.2с реле tianbo tianbo, упак.: 0,040 тыс.шт.
hjq-22f- 12vdc-5a-конт.3с реле tianbo tianbo, упак.: 0,001 тыс.шт.
hjq-22f- 12vdc-5a-конт.4с реле tianbo tianbo, упак.: 0,040 тыс.шт.
hjq-22f- 24vdc-5a-конт.2с реле tianbo tianbo, упак.: 0,040 тыс.шт.
hjq-22f- 24vdc-5a-конт.3с реле tianbo tianbo, упак.: 0,040 тыс.шт.
hjq-22f- 24vdc-5a-конт.4с реле tianbo tianbo, упак.: 0,040 тыс.шт.
hjq-22f-110vac-5a-конт.3с- реле tianbo tianbo, упак.: 0,040 тыс.шт.
hjq-22f-110vac-5a-конт.4с реле tianbo tianbo, упак.: 0,001 тыс.шт.
hjq-22f-220vac-5a-конт.2с реле tianbo tianbo, упак.: 0,040 тыс.шт.
hjq-22f-220vac-5a-конт.3с реле tianbo tianbo, упак.: 0,040 тыс.шт.
hjq-22f-220vac-5a-конт.4с реле tianbo tianbo, упак.: 0,040 тыс.шт.
hjq-22f-3z ~24в доп. инф.: реле н.уп.:
hjq-22f-48vac-4z доп. инф.: (4 x 5a) ~48v ac, 4 группы x 5a, tianbo
hjq-22f-4z coil ac-220в доп. инф.: реле 5a 240 vac 5f 28 vdc, импорт н.уп.:
hjq-22f-4z coilac -24в доп. инф.: реле 5a 240 vac 5a 28vdc, импорт н.уп.:

pyf11a (для реле hjq-22f-3c) колодка tianbo (без фиксатора) tianbo, упак.: 0,020 тыс.шт.

pyf14a (для реле hjq-22f-4c) колодка tianbo (без фиксатора) tianbo, упак.: 0,020 тыс.шт.

tf11a (для реле hjq-22f-3c) колодка tianbo + фиксатор tianbo, упак.: 0,010 тыс.шт.

hjq-22f-12vdc-2z 5a шт

hjq-22f-240vac-2z 5a шт

hjq-22f-24vdc-3z 5a шт

hjq-22f-24vdc-4z 5a шт

hjq-22f-48vdc-4zp

реле hjq-22f-24vac-4z,5a

реле hjq-22f-24vdc-4z

hjq-22f-240vac-2z 5a

hjq-22f-24vdc-4z 5a

hjq-22f-4z coil ac-220в (5a240 vac, 5a28 vdc) реле сколкой tp514x

реле имп, 24v hjq-22f-24vdc-4z

hjq-22f-240vac-2z 5a импорт, оптовая цена от шт.

hjq-22f-24vdc-4z 5a импорт, оптовая цена от шт.

hjq-22f-12vdc-2z 5a электромагнитные реле (импорт

hjq-22f-240vac-2z 5a электромагнитные реле (импорт

hjq-22f-24vdc-4z 5a электромагнитные реле (импорт

`hjq-22f-12vdc-2z 5a

`hjq-22f-240vac-2z 5a

`hjq-22f-24vdc-4z 5a

`hjq-22f-24vdc-4z 5a

hjq-22f-12vdc-2z 5a

hjq-22f-240vac-2z 5a

hjq-22f-24vdc-3z 5a

hjq-22f-24vdc-4z 5a

hjq-22f-12vdc-2z 5a электромагнитные реле (импорт

hjq-22f-240vac-2z 5a электромагнитные реле (импорт
hjq-22f-24vdc-3z 5a электромагнитные реле (импорт
hjq-22f-24vdc-4z 5a электромагнитные реле (импорт
hjq-22f-24vdc-4z 5a, реле
hjq-22f 24vdc-3z
hjq-22f 24vdc-4z
hjq-22f- 12vdc-5a-конт.2с реле tianbo tianbo
hjq-22f- 12vdc-5a-конт.3с реле tianbo tianbo
hjq-22f- 12vdc-5a-конт.4с реле tianbo tianbo
hjq-22f- 24vdc-5a-конт.2с реле tianbo tianbo
hjq-22f- 24vdc-5a-конт.3с реле tianbo tianbo
hjq-22f- 24vdc-5a-конт.4с реле tianbo tianbo
hjq-22f-110vac-5a-конт.3с- реле tianbo tianbo
hjq-22f-110vac-5a-конт.4с реле tianbo tianbo
hjq-22f-110vdc-2z
hjq-22f-110vdc-4z
hjq-22f-12vdc-2z
hjq-22f-12vdc-2z 5a
hjq-22f-12vdc-3z 5a
hjq-22f-12vdc-4z
hjq-22f-220vac-5a-конт.2с реле tianbo tianbo
hjq-22f-220vac-5a-конт.3с реле tianbo tianbo
hjq-22f-220vac-5a-конт.4с реле tianbo tianbo
hjq-22f-240vac-2z
hjq-22f-240vac-2z 5a
hjq-22f-240vac-3z 5a
hjq-22f-240vac-3zp
hjq-22f-240vac-4z

Минск +3752447584780 Viber email minsk17@tut.by

hjq-22f-24d -24в
hjq-22f-24vac-2z
hjq-22f-24vac-2z 5a
hjq-22f-24vac-3z
hjq-22f-24vac-3z 5a
hjq-22f-24vac-4z (4 x 5a)
hjq-22f-24vac-4z -4453
hjq-22f-24vdc-2z
hjq-22f-24vdc-2z 5a
hjq-22f-24vdc-3z 5a
hjq-22f-24vdc-3zp
hjq-22f-24vdc-4z
hjq-22f-24vdc-4z 5a
hjq-22f-24vdc-4z 5a (smet-424dt)
hjq-22f-3z ~24в , (имп) ~24
hjq-22f-48vac-4z
hjq-22f-48vac-4z (4 x 5a)
hjq-22f-4z coil ac-220в , -220 5a 240 vac 5f 28 vdc, импорт
hjq-22f-4z coil-ac-24v
hjq-22f-4z coilac -24в , -24 5a 240 vac 5a 28vdc, импорт
ptf11a (для реле hjq-22f-3c) колодка tianbo + фиксатор tianbo
pyf11a (для реле hjq-22f-3c) колодка tianbo (без фиксатора) tianbo
pyf14a (для реле hjq-22f-4c) колодка tianbo (без фиксатора) tianbo
tf11a (для реле hjq-22f-3c) колодка tianbo + фиксатор tianbo
реле hjq-22f-2z 2z 5a 12v
реле hjq-22f-4z 4z 5a 12v
реле hjq-22f-4z 4z 5a 220v
реле hjq-22f-4z 4z 5a 24v

hjq-22f-24vdc-4c tianbo

hjq-22f

hjq-22f-24vdc-4c tianbo, jzx-18ff-4c-a-24dc-1

реле 24vac 5a 11 pin (общ. назнач.) hjq-22f-24vac-3z (рэк78/3)

hjq-22f-110vdc-2z

hjq-22f-110vdc-4z

hjq-22f-12vdc-2z

hjq-22f-12vdc-4z

hjq-22f-240vac-2z

hjq-22f-240vac-3zp

hjq-22f-240vac-4z

hjq-22f-24vac-2z

hjq-22f-24vac-3z

hjq-22f-24vdc-2z

hjq-22f-24vdc-3zp

hjq-22f-24vdc-4z

hjq-22f-48vdc-4zp

hjq-22f-110vdc-2z

hjq-22f-110vdc-4z

hjq-22f-12vdc-2z

hjq-22f-12vdc-4z

hjq-22f-240vac-2z

hjq-22f-240vac-3zp

hjq-22f-240vac-4z

hjq-22f-24vac-2z

hjq-22f-24vac-3z

hjq-22f-24vdc-2z

hjq-22f-24vdc-3zp

Минск +3752447584780 Viber email minsk17@tut.by

hjq-22f-24vdc-4z

hjq-22f-48vdc-4zp

hjq-22f- 12vdc-5a-конт.2с реле tianbo

hjq-22f- 12vdc-5a-конт.3с реле tianbo

hjq-22f- 12vdc-5a-конт.4с реле tianbo

hjq-22f- 24vdc-5a-конт.2с реле tianbo

hjq-22f- 24vdc-5a-конт.3с реле tianbo

hjq-22f- 24vdc-5a-конт.4с реле tianbo

hjq-22f-110vac-3z

hjq-22f-110vac-5a-конт.3с- реле tianbo

hjq-22f-110vac-5a-конт.4с реле tianbo

hjq-22f-12vdc-2z 5a

hjq-22f-12vdc-3z 5a

hjq-22f-220vac-5a-конт.2с реле tianbo

hjq-22f-220vac-5a-конт.3с реле tianbo

hjq-22f-220vac-5a-конт.4с реле tianbo

hjq-22f-240vac-2z 5a

hjq-22f-240vac-3z 5a

hjq-22f-240vac-3zp 5a

hjq-22f-24vac-2z 5a

hjq-22f-24vac-3z 5a

hjq-22f-24vdc-2z 5a

hjq-22f-24vdc-3z 5a

hjq-22f-24vdc-3zp 5a

hjq-22f-24vdc-4с

hjq-22f-24vdc-4z 5a

hjq-22f-24vdc-4z 5a, реле

ptf11a (для реле hjq-22f-3с) колодка tianbo + фиксатор

руф11а (для реле hjq-22f-3с) колодка tianbo (без фиксатора)

руф14а (для реле hjq-22f-4с) колодка tianbo (без фиксатора)

hjq-22f-240vac-2z 5a // моq>6

hjq-22f-24vdc-4с

hjq-22f-2z-12vdc (2 группы)

hjq-22f-2z-220vac (2 группы)

hjq-22f-2z-24vdc (2 группы)

hjq-22f-3z- 12vdc (3 группы)

hjq-22f-3z- 24vdc (3 группы)

hjq-22f-3z-24vac (3 группы)

hjq-22f-3z~ 220vac (3 группы)

hjq-22f-4z- 12vdc (4 группы)

hjq-22f-4z- 24vdc (4 группы)

hjq-22f-4z- 48vdc (4 группы)

hjq-22f-4z~110vac (4 группы)

hjq-22f-4z~12vac (4 группы)

hjq-22f-4z~220vac (4 группы)

hjq-22f-4z~24vac (4 группы)

колодка дуф11а для реле hjq-22f-3с (без клипс)

колодка дуф14а для реле hjq-22f-4с (без клипс)

колодка рtf11а для hjq-22f-3с (с клипсами)

колодка рtf14а for hjq-22f-4с with clips

колодка руф11а для реле hjq-22f-3с (без клипс)

колодка руф14а для реле hjq-22f-4с (без клипс)

колодка тр511х / аналог рtf11а для реле hjq-22f-3с (с клипсами)

реле hjq-22f-110vac-3z

реле hjq-22f-110vac-4z

реле hjq-22f-12vac-4z

реле hjq-22f-12vdc-3z

реле hjq-22f-12vdc-4z

реле hjq-22f-220vac-3z

реле hjq-22f-220vac-4z

реле hjq-22f-24vac-4z

реле hjq-22f-24vdc-2zp

реле hjq-22f-24vdc-3z

реле hjq-22f-24vdc-4z

реле hjq-22f-24vdc-4z-d

реле hjq-22f-60vdc-4z

hjq22f12vdc2z5a

hjq22f12vdc3z5a

hjq22f12vdc4z tianbo ganglian electronics (ningbo)

hjq22f12vdc4zp tianbo ganglian electronics (ningbo)

hjq22f240vac3z5a

hjq22f24vac2z5a

hjq22f24vac3z5a

hjq22f24vdc2z5a

hjq22f24vdc3z5a

hjq22f24vdc4c tianbo ganglian electronics (ningbo)

hjq22f24vdc4z tianbo ganglian electronics (ningbo)

hjq22f24vdc4z5a

hjq-22f-24vdc-4z

hjq-22f-4z

hjq-22f-3z

tianbo hjq-22f-4z

hjq-22f-2z

hjq-22f-4z технические характеристики

hjq-22f-24vdc-4z 5a

реле hjq-22f-4z

hjq-22f-3z 220vac

**Минск +375447584780 Viber email minsk17@tut.by
www.fotorele.net www.tiristor.by tel.+375 29 758 47 80 МТС**

каталог, описание, технические, характеристики, datasheet, параметры, маркировка, габариты, фото,
РЕЛЕ

купить, продажа



Электронные компоненты, радиодетали

[где и как купить в Минске?](#)

Категория: **РЕЛЕ TIANVO,**



HJQ-22F

SPECIFICATION

FILE NUMBER: P-08KD401A

DATE: 2001/11/02



■ Features

- 4 pole configurations
- Au-clad contact available

■ CONTACT DATA

Contact Form	4C/2C	
Contact Material	AgCdO	
Contact Ratings	5A 240VAC/30VDC	
Max Switching Voltage	250VAC/30VDC	
Max Switching Current	5A	
Max Switching Power	1750VA/210W	
Contact Resistance	100m Ω Max	at 6VDC 1A
Life Expectancy Electrical	100,000	Operations(at30Operations/minute)
Machanical	10,000,000	Operations

■ GENERAL DATA

Insulation Resistance	100MΩ Min at 500VDC	
Dielectric Strength Between Open Contacts	1000VAC(for one minute)	
Between Contacts and coil	1500VAC(for one minute)	
Operate Time	25ms	
Release Time	25ms	
Temperature Range	-40°C to+70 °C	
Shock Resistance	Operating Extremes	20G
	Damage Limits	100G
Vibration Resistance	10-55Hz,1.5mm	
Humidity	40-85%	
Weight	Approx 35g	
Safety Standard	CSA:203664 UL:E209198	



■ COIL DATA(4Z)

Nominal Voltage		Coil Resistance at 20±10%(Ω)		Max Operate Voltage		Min Release Voltage		Max Applicable Voltage	
5-110VDC	6-240VAC	VDC	VAC	VDC	VAC	VDC	VAC	VDC	VAC
		0.9W	1.2VA						
5	6	27.5	11.5	3.75	4.8	0.5	0.6	6.5	7.8
6	12	40	46	4.5	9.6	0.6	1.2	7.8	15.6
12	24	160	184	9	19.2	1.2	2.4	15.6	31.2
24	48	650	735	18	38.4	2.4	4.8	31.2	62.4
48	110	2600	4550±15%	36	88	4.8	11	62.4	143
110	120	11000	4550±15%	82.5	96	11	12	143	156
	220/240		14400±15%		176		24		286/312

■ ORDERING CODE

HJQ-22F-12VDC-4Z(P)---1---F--D

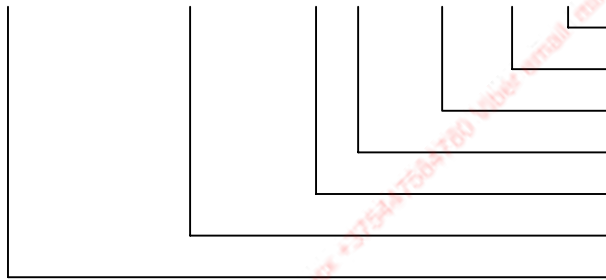

- With LED
- With Flange for 38mm pitch hole
- Bifurcated moving spring
- P: PCB Type Nil: B Type
- 2Z Form 2C 4Z Form 4C
- Coil Nominal Voltage
- Relay Model

OVERALL AND MOUNTING DIMENSIONS

MOUNTING COVER

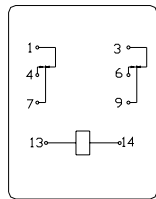
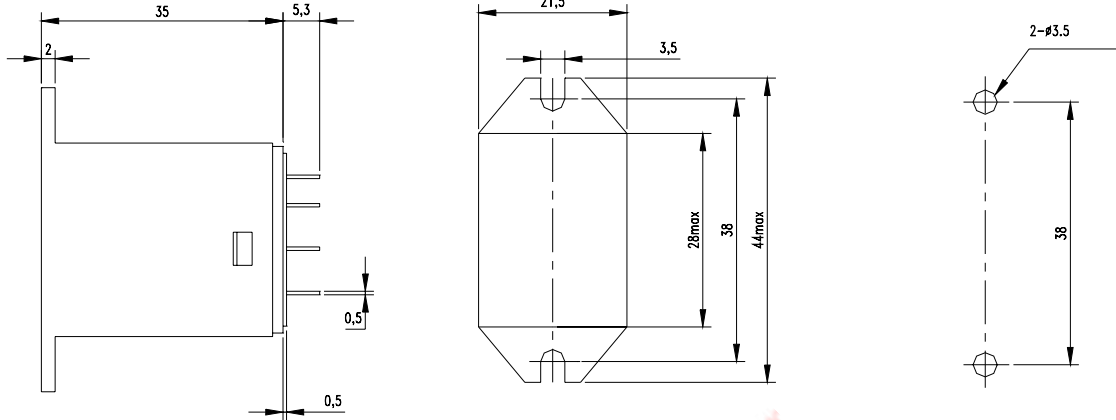

2C Terminal Arrangement/
Internal Connections
(Bottom view)

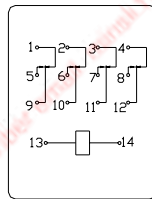

4C Terminal Arrangement/
Internal Connections
(Bottom view)

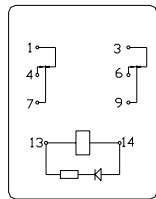

2CD

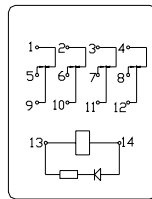

4CD

Minix +375847584780 Vivaldi.com.cn 17 (Unit by)



B Type Terminals

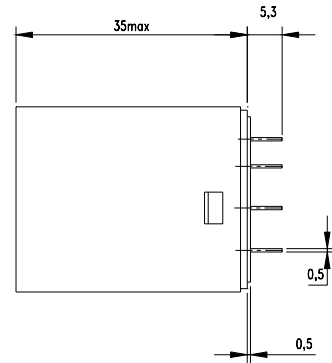
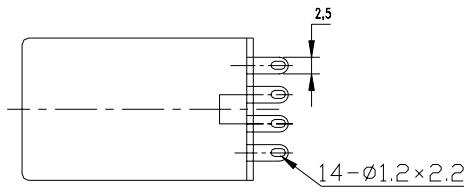

P Type Terminals

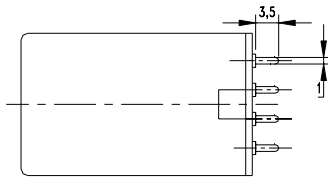

P Type PCB Mounting

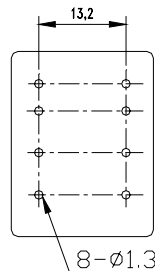
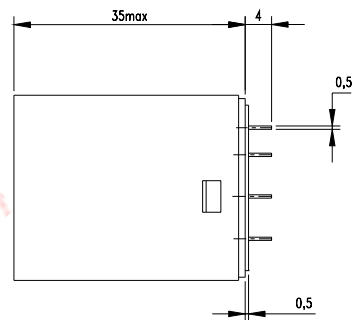

2C

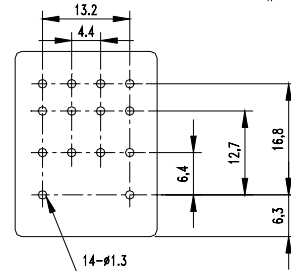

4C

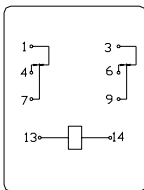

2C Terminal Arrangement/
Internal Connections
(Bottom view)

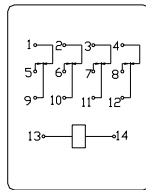

4C Terminal Arrangement/
Internal Connections
(Bottom view)

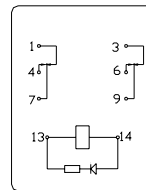

2CD

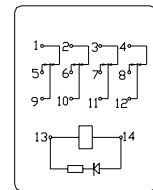

4CD

通用继电器	HJQ-22F
-------	---------

- 2 to 3 pole configurations
- Conform to RoHS,ELV directive



28×21.5×35

03001008347

E173485

203664

ORDERING CODE 订购代码

HJQ-22F — 2Z (P) — F — D / 12VDC					
1	2	3	4	5	6
1. Relay Model 继电器型号	2. 触点转换形式			4. With Flange for 38mm pitch hole	
	2Z: Form 2C 3Z: Form 3C			5. With LED	
3. P: PCB Type Nil: B Type				6. Coil Nominal Voltage 线圈额定电压	
				5,6,12,24,48,110VDC	
				6,12,24,48,110,120,220/240VAC	

COIL DATA 线圈参数 (at 20°C)

Nominal Voltage额定电压(VDC)	5	6	12	24	48	110/120	220/240	0.9W
Coil Resistance线圈阻值(Ω)	28	40	160	640	2560	11000		
Rated Current额定电流(mA)	178.5	150	75	37.5	18.75	10		
Max Operate Voltage 最大吸合电压(VDC)	3.75	4.5	9	18	36	82.5		
Min Release Voltage最小释放电压(VDC)	0.5	0.6	1.2	2.4	4.8	11		1.2VA
Nominal Voltage额定电压(VAC)		6	12	24	48	110/120	220/240	
Coil Resistance线圈阻值(Ω)		11.5	46	184	735	4550	14400	
Max Operate Voltage 最大吸合电压(VAC)		4.8	9.6	19.2	38.4	88	176	
Min Release Voltage最小释放电压(VAC)		1.2	2.4	4.8	9.6	22	44	
Max Applicable Voltage最大过载电压	70°C时额定电压的130%，23°C时额定电压的170%							

注: 5-24VDC/6-48VAC 线圈阻值公差为±10%，48-110VDC/110-240VAC 线圈阻值公差为±15%。

CONTACT DATA 触点参数

Contact Form触点形式	2Z/3Z
Contact Material触点材料	Silver Alloy
Load负载	Resistive load(COS Φ=1)
Contact Ratings触点负载	7A 240VAC 7A 30VDC
Minimum load 最小负载	100mA 5VDC
Max Switching Voltage最大转换电压	240VAC/30VDC
Max Switching Current最大转换电流	7A
Max Switching Power 最大转换功率	1680VA/210W
Contact Resistance接触电阻	100m Ω Max at 6VDC 1A
Life Expectancy寿命	Electrical 电气寿命: 100,000 Operations(at30Operations/minute)
	Mechanical机械寿命: 10,000,000 Operations(at3000Operations/minute)

■ CHARACTERISTICS DATA 性能参数

Insulation Resistance 绝缘阻值	100M Ω Min at 500VDC
Dielectric Strength Between Open Contacts 触点间耐压	1000VAC(for one minute)
Between Contacts and coil 触点与线圈间耐压	1500VAC(for one minute)
Operate Time 吸合时间	25ms
Release Time 释放时间	25ms
Temperature Range 环境温度	-40 $^{\circ}$ C to +70 $^{\circ}$ C
Shock Resistance 冲击	Operating Extremes 动作极限: 20G
	Damage Limits 破坏极限: 100G
Vibration Resistance 振动	10-55Hz, 1.5mm
Max. switching frequency 最大转换频率	Mechanical: 18,000operations/hr
	Electrical: 1,800operations/hr
Humidity 湿度	40-85%
Weight 重量	Approx 35g
Safety Standard 安全标准	UL cUL CQC CSA

■ APPROVED STANDARDS 安全标准

Model(型号)	Coiling rating (线圈电压)	Safety Standard (安全标准)	Contact rating (触点负载)
HJQ-22F	12 to 110VDC	UL/cUL	7A 240VAC
	24 to 240VAC		7A 30VDC
	5 to 110VDC	CQC	5A 240VAC
	24 to 240VAC		5A 28VDC
	12 to 110VDC	CSA	5A 240VAC
	120 to 240VAC		5A 28VDC

■ ENGINEERING DATA 设计参数

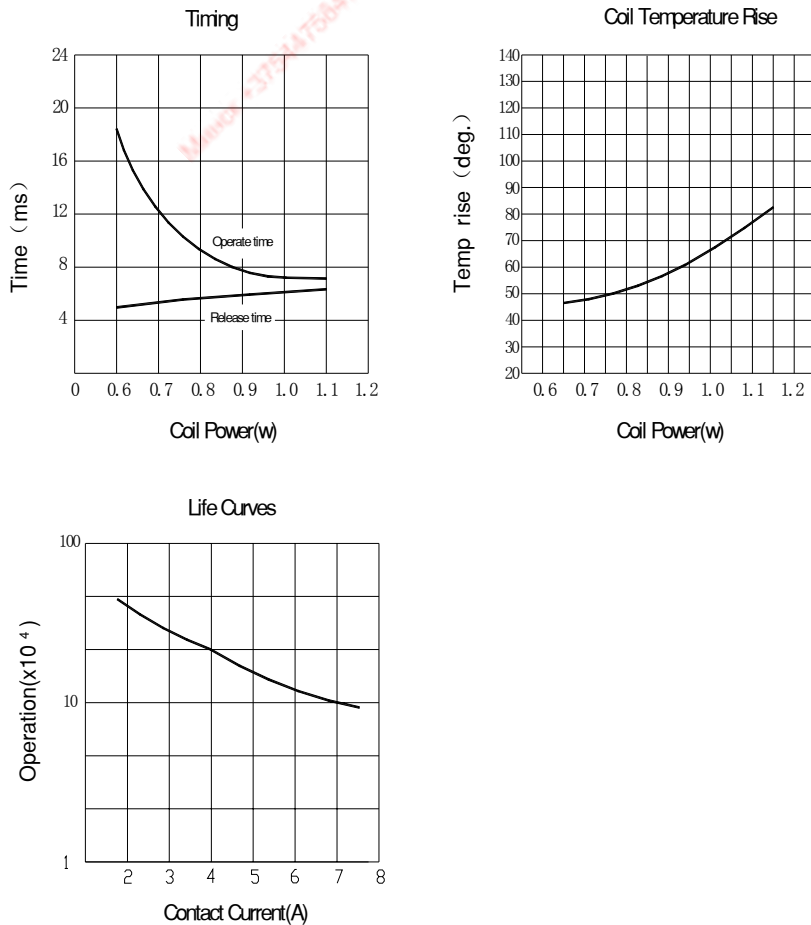

■ OVERALL AND MOUNTING DIMENSIONS 安装图

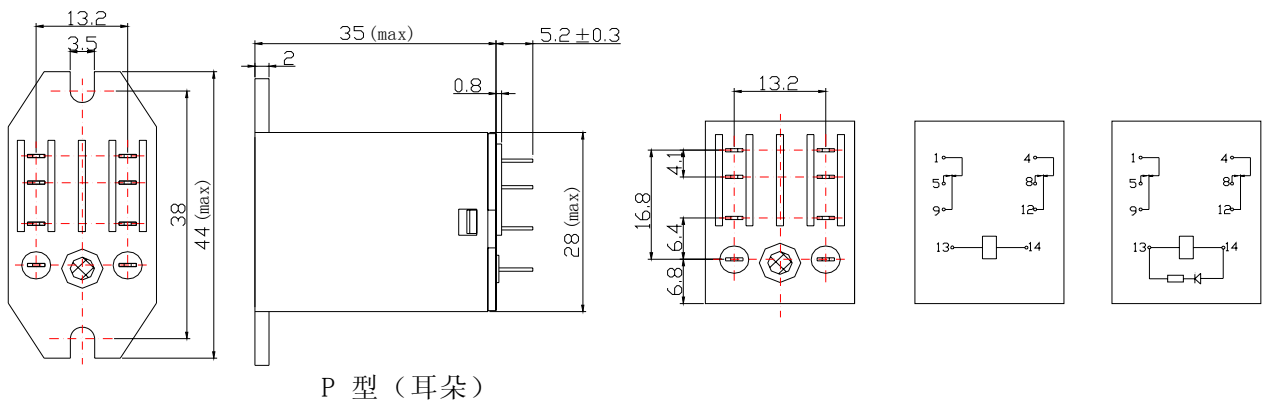
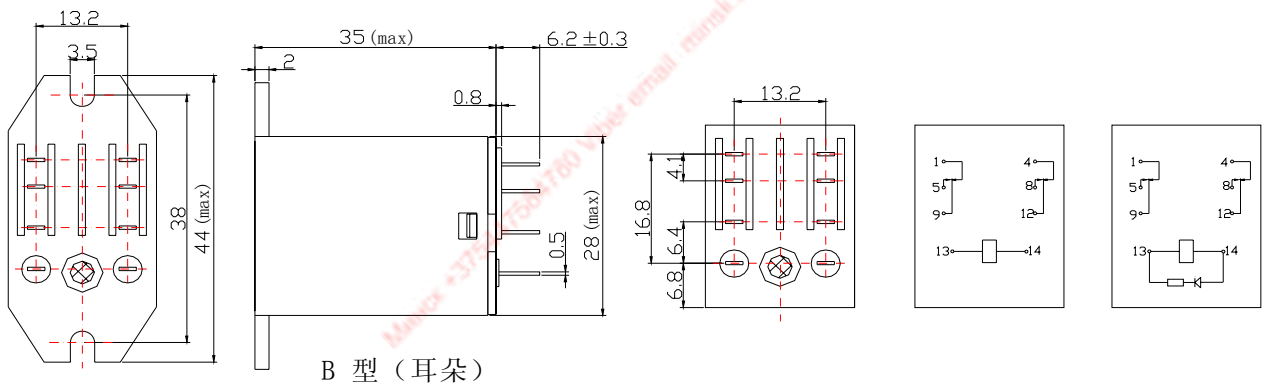
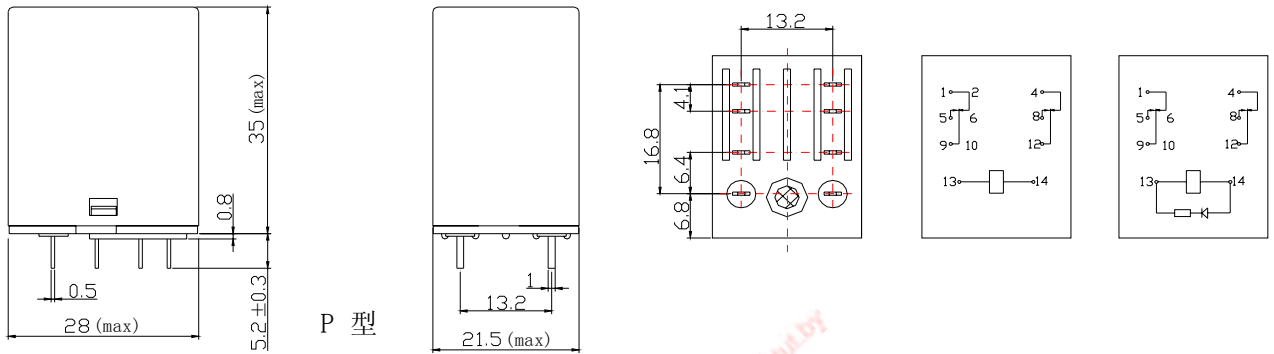
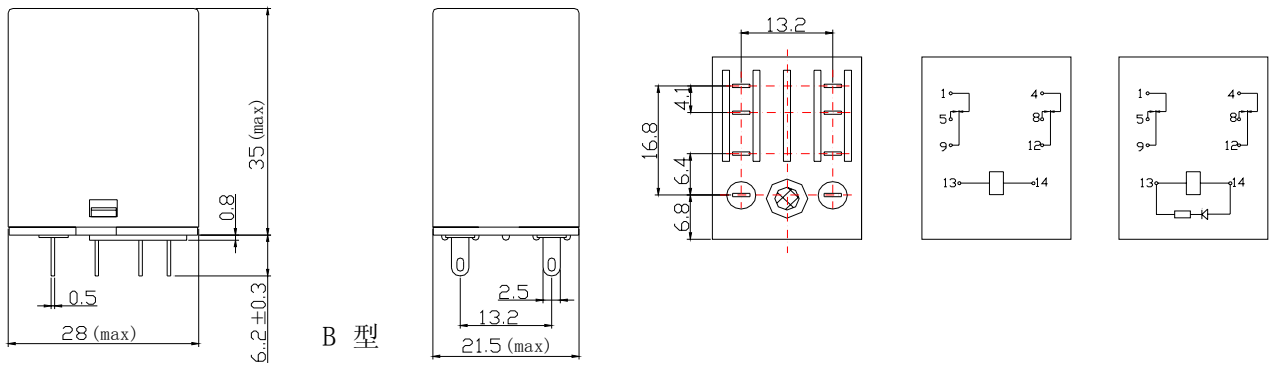

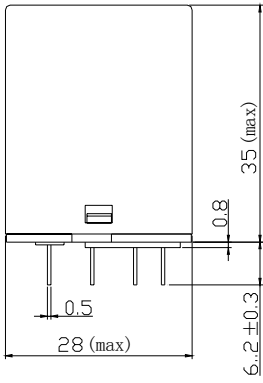

B 型

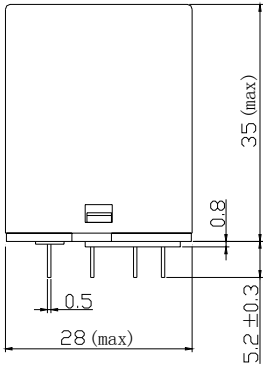
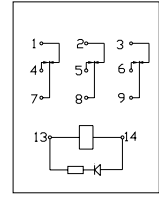
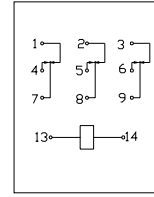
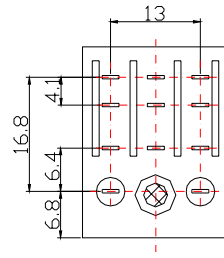
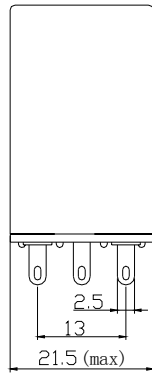

P 型

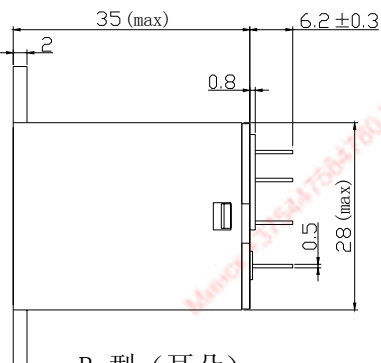
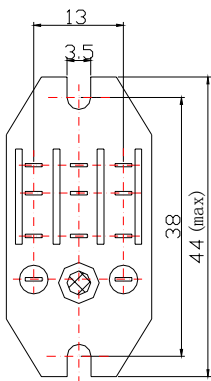
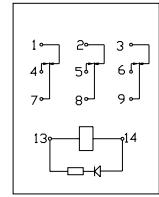
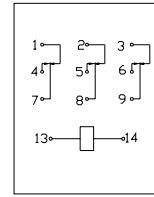
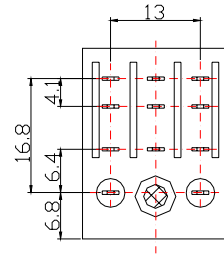
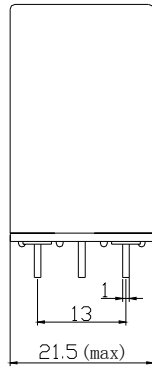

B 型 (耳朵)

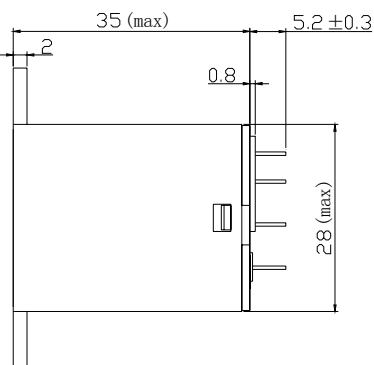
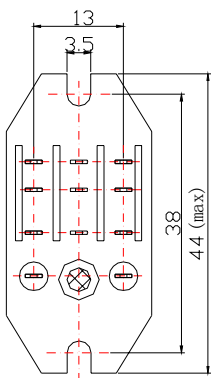
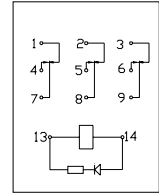
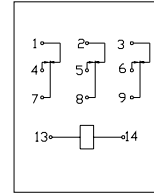
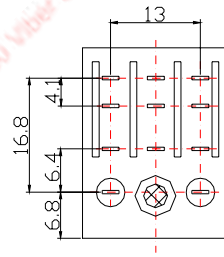

P 型 (耳朵)

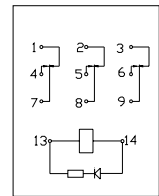
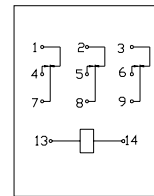
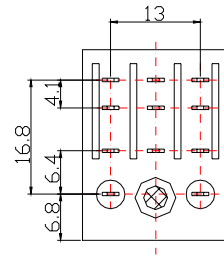

声明:

本产品规格书仅供客户使用时参考, 如有更改, 恕不另行通知。