



**Slim (7.2mm .283inch),  
1 Form A 5A power relay**

# LD-P RELAYS (ALDP)



**RoHS compliant**

Protective construction: Sealed type

### FEATURES

1. **Nominal switching capacity:  
5A 277V AC**
2. **Excellent heat resistance and tracking performance**  
EN60695 (GWT2-11, GWF12-12, GWIT2-13) data available  
(Please consult us for details.)
3. **Slim type: 20.5 (L) × 7.2 (W) × 15.3 (H) mm .807 (L) × .283 (W) × .602 (H) inch**
4. **Class “B” and “F” coil is available**
5. **Contact rating at 105°C 221°F is approved by UL/C-UL and VDE (Class “F” coil only)**
6. **Clearance and Creepage distance between contact and coil min. 6 mm .236 inch**
7. **High surge voltage: 10,000 V between contact and coil**

### TYPICAL APPLICATIONS

- Boilers
- Air conditioner
- Refrigerator
- Hot water units
- Microwave ovens
- Fan heaters

### ORDERING INFORMATION

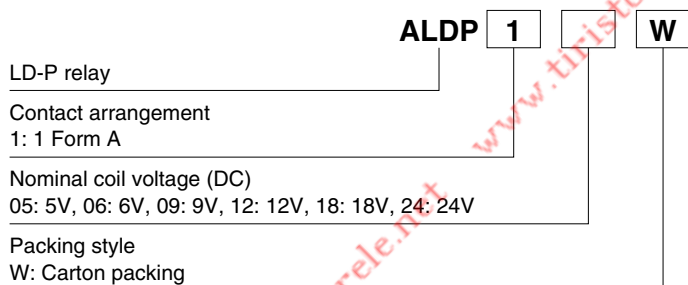

Notes: 1. Certified by UL/C-UL, VDE and CQC  
2. Class “B” and “F” coil is available (Class “B”: ALDP1B\*\*W, Class “F”: ALDP1F\*\*W)

### TYPES

Contact arrangement	Nominal coil voltage	Part No.
1 Form A	5V DC	ALDP105W
	6V DC	ALDP106W
	9V DC	ALDP109W
	12V DC	ALDP112W
	18V DC	ALDP118W
	24V DC	ALDP124W

Packing quantity: Carton 100 pieces, Case 500 pieces

Note: The “W” at the end of the part number only appears on the inner and outer packaging. It does not appear on the relay itself.

Please consult with our sales office on a tube packing type.

# RATING

## 1. Coil data

Nominal coil voltage	Pick-up voltage (at 20°C 68°F)	Drop-out voltage (at 20°C 68°F)	Nominal operating current [±10%] (at 20°C 68°F)	Coil resistance [±10%] (at 20°C 68°F)	Nominal operating power	Max. applied voltage (at 20°C 68°F)
5V DC	75%V or less of nominal voltage (Initial)	5%V or more of nominal voltage (Initial)	40.0mA	125Ω	200mW	130%V of nominal voltage
6V DC			33.3mA	180Ω		
9V DC			22.2mA	405Ω		
12V DC			16.7mA	720Ω		
18V DC			11.1mA	1,620Ω		
24V DC			8.3mA	2,880Ω		

## 2. Specifications

Characteristics	Item	Specifications	
Contact	Arrangement	1 Form A	
	Contact resistance (Initial)	Max. 100 mΩ (By voltage drop 6 V DC 1A)	
	Contact material	AgNi type	
Rating	Nominal switching capacity (resistive load)	5A 277V AC, 3A 30V DC	
	Max. switching power (resistive load)	1,385VA, 90W	
	Max. switching voltage	277V AC, 30V DC	
	Max. switching current	5A (AC), 3A (DC)	
	Min. switching capacity (reference value)*1	100mA 5V DC	
Electrical characteristics	Insulation resistance (Initial)	Min. 1,000MΩ (at 500V DC) Measurement at same location as "Breakdown voltage" section.	
	Breakdown voltage (Initial)	Between open contacts	750 Vrms for 1 min. (Detection current: 10 mA)
		Between contact and coil	4,000 Vrms for 1 min. (Detection current: 10 mA)
	Surge breakdown voltage*2 (Between contact and coil) (Initial)	10,000 V	
	Operate time (at nominal voltage) (at 20°C 68°F)	Max. 10 ms (excluding contact bounce time.)	
Release time (at nominal voltage) (at 20°C 68°F)	Max. 10 ms (excluding contact bounce time) (With diode)		
Mechanical characteristics	Shock resistance	Functional	300 m/s <sup>2</sup> (Half-wave pulse of sine wave: 11 ms; detection time: 10μs.)
		Destructive	1,000 m/s <sup>2</sup> (Half-wave pulse of sine wave: 6 ms.)
	Vibration resistance	Functional	10 to 55 Hz at double amplitude of 1.5 mm (Detection time: 10μs.)
		Destructive	10 to 55 Hz at double amplitude of 1.5 mm
Expected life	Mechanical (at 180 times/min.)	Min. 5×10 <sup>6</sup>	
	Electrical (at 20 times/min.) (resistive load)	Min. 2×10 <sup>5</sup> (5A 125V AC at rated load), Min. 10 <sup>5</sup> (5A 250V AC, 3A 30V DC)	
Conditions	Conditions for operation, transport and storage*3	Ambient temperature: -40°C to +85°C -40°F to +185°F; Humidity: 5 to 85% R.H. (Not freezing and condensing at low temperature)	
	Max. operating speed	20 times/min. (at nominal switching capacity)	
Unit weight		Approx. 4 g .14 oz	

Notes: \*1. This value can change due to the switching frequency, environmental conditions, and desired reliability level, therefore it is recommended to check this with the actual load.

\*2. Wave is standard shock voltage of ±1.2×50μs according to JEC-212-1981

\*3. The upper limit of the ambient temperature is the maximum temperature that can satisfy the coil temperature rise value. Refer to Usage, transport and storage conditions in NOTES.

# REFERENCE DATA

### 1. Max. switching power

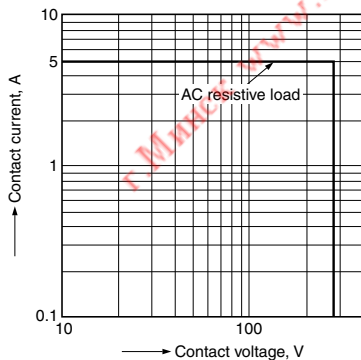

### 2. Life curve

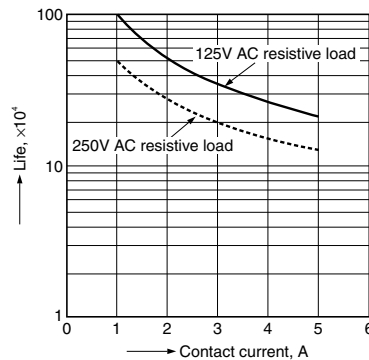

### 3. Coil temperature rise

Sample: ALDP112, 6 pcs.  
Point measured: inside the coil  
Contact current: 0 A, 5 A

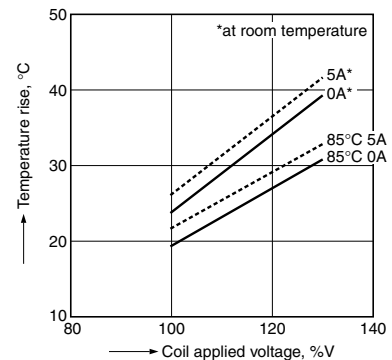

4-(1). Operate time

Sample: ALDP112, 30 pcs.

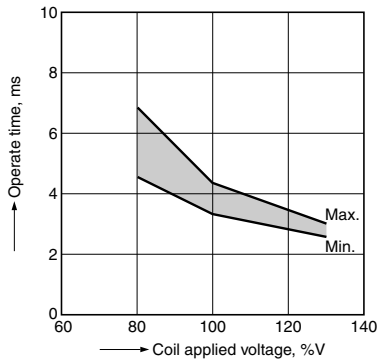

4-(2). Release time (without diode)

Sample: ALDP112, 30 pcs.

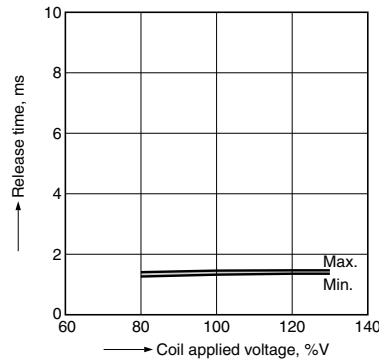

4-(3). Release time (with diode)

Sample: ALDP112, 30 pcs.

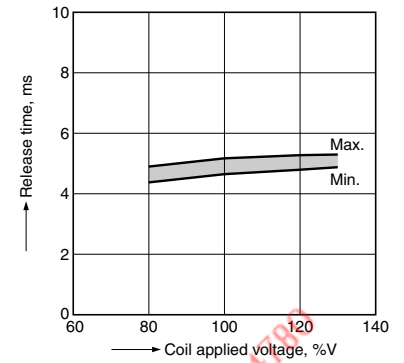

5. Electrical life test

(5A 250V AC Resistive load)

Sample: ALDP112, 6 pcs.

Operation frequency: 20 times/min.

(ON:OFF = 1.5s:1.5s)

Circuit:

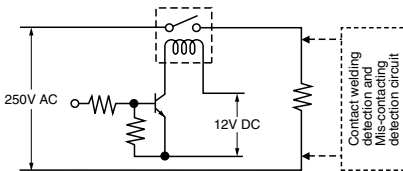

Change of pick-up and drop-out voltage

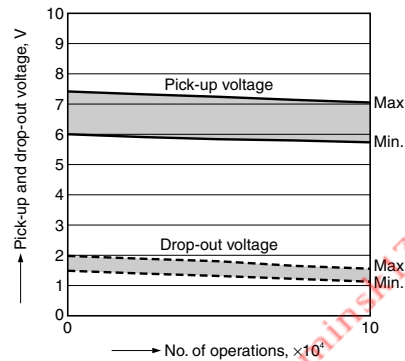

Change of contact resistance

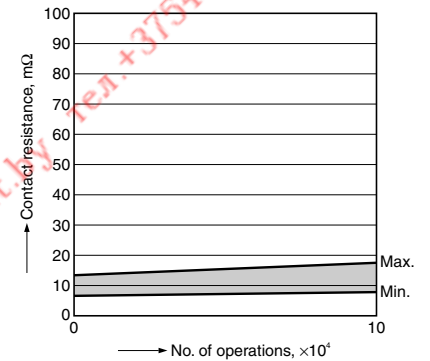

**DIMENSIONS** (mm inch)

The CAD data of the products with a **CAD** mark can be downloaded from: <http://industrial.panasonic.com/ac/e/>

**CAD**



External dimensions

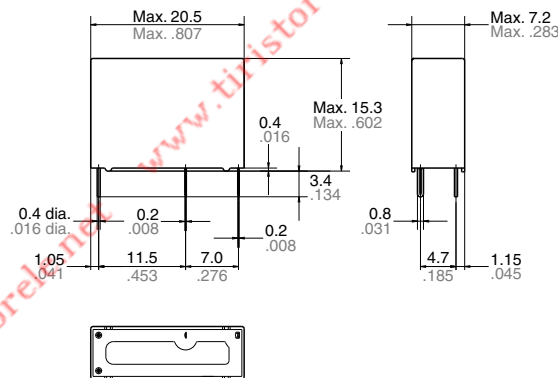

PC board pattern (Bottom view)

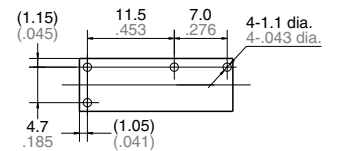

Tolerance: ±0.1 ±.004

Schematic (Bottom view)

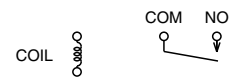

Dimension:

Less than 1mm .039inch:

Min. 1mm .039inch less than 3mm .118 inch: ±0.2 ±.008

Min. 3mm .118 inch:

General tolerance

±0.1 ±.004

±0.2 ±.008

±0.3 ±.012

## SAFETY STANDARDS

UL/C-UL(Recognized)*1				VDE (Certified)				CQC			
File No.	Load	Temp.	Cycles	File No.	Load	Temp.	Cycles	File No.	Load	Temp.	Cycle
E43028	5A 277V AC Resistive	85°C 185°F	10 <sup>5</sup>	40014384	5A 250V AC (cosφ=1.0)	85°C 185°F	10 <sup>5</sup>	CQC10002048611	5A 250V AC	85°C 185°F	10 <sup>4</sup>
	5A 30V DC Resistive	—	10 <sup>5</sup>		5A 30V DC (0ms)	25°C 77°F	10 <sup>4</sup>		—	—	—
	6A 277A AC	—	5 × 10 <sup>4</sup>		5A 250V AC (cosφ=1.0)*2	105°C 221°F	5 × 10 <sup>4</sup>		—	—	—
	3A 277V AC General use	85°C 185°F	12 × 10 <sup>4</sup>		—	—	—		—	—	—
	5A 277V AC Resistive*2	105°C 221°F	5 × 10 <sup>4</sup>		—	—	—		—	—	—
	Pilot duty, C300	85°C 185°F	10 <sup>5</sup>		—	—	—		—	—	—
	Pilot duty, 0.65A 277V AC (Inrush 6.5A)	85°C 185°F	10 <sup>5</sup>		—	—	—		—	—	—

Notes: \*1. CSA standard: Certified by C-UL

\*2. For Insulation Class F models only (Coil class F)

EN/IEC VDE Certified  
INSULATION CHARACTERISTIC (IEC61810-1)

Item	Characteristic	
Clearance/Creepage distance (IEC61810-1)	Min. 5.5mm/5.5mm	
Category of protection (IEC61810-1)	RTIII	
GWT (IEC60335-1)	GWF1850/GWT750 2s (base)/GWIT775 (cover)	
Tracking resistance (IEC60112)	PT1175	
Insulation material group	IIIa	
Over voltage category	III	III
Impulse Withstand Voltage	4 kV	6 kV
Rated voltage	250V	250V
Pollution degree	3	2
Type of insulation (Between contact and coil)	Basic Insulation	Reinforced Insulation
Type of insulation (Between open contact)	Micro Disconnection	

## NOTES

1. For cautions for use, please read "GENERAL APPLICATION GUIDELINES".

2. Usage, transport and storage conditions

1) Temperature:

−40 to +85°C −40 to +185°F

2) Humidity: 5 to 85% RH

(Avoid freezing and condensation.)

The humidity range varies with the temperature. Use within the range indicated in the graph below.

3) Atmospheric pressure: 86 to 106 kPa

Temperature and humidity range for usage, transport, and storage

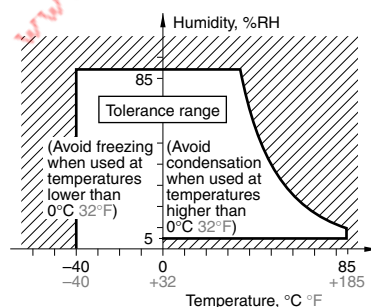

3. Certification

1) This relay is UL/C-UL certified.

UL/C-UL standards:

5 A 277 V AC 85°C 185°F

5 A 30 V DC

2) This relay is certified by VDE.

VDE standards:

5 A 250 V AC cosφ = 1.0 85°C 185°F

5 A 30 V DC 0ms

3) UL/C-UL and VDE certified ratings are displayed on the packaging box.

(On the relay, only the certification marks are shown and not the certified ratings.

Please refer to the product specification diagrams to see what is stamped.)

4. Part number display

The "W" at the end of the part number only appears on the inner and outer packaging. It does not appear on the relay itself.

5. Creepage distance and clearances between contact and coil: Min. 6 mm .236 inch

г. Минск [www.fotorele.net](http://www.fotorele.net) [www.tiristor.by](http://www.tiristor.by) email [minsk17@tut.by](mailto:minsk17@tut.by) тел. +375447584780

Please contact .....

## Panasonic Corporation

Electromechanical Control Business Division

■ 1006, Oaza Kadoma, Kadoma-shi, Osaka 571-8506, Japan  
[industrial.panasonic.com/ac/e/](http://industrial.panasonic.com/ac/e/)

# Panasonic®

©Panasonic Corporation 2016