



RV8H Series	RJ Series	RQ Series	RH Series	RR Series
756	759	769	773	783
1 form C (SPDT)	SPDT, SPST, DPDT, DPST	SPDT, DPDT	SPDT, DPDT, 3PDT, 4PDT	SPDT, DPDT, 3PDT
Screw	Blade or PCB	PCB	Blade or PCB	Pin or Blade
6A 30VDC/250VAC	SPDT: 12A/16A, 30V DC/250V AC DPDT: 8A, 30V DC/250V AC	SPDT: 12A, 16A DPDT: 8A	10A, 30V DC/240V AC 1/3HP, 240V AC 1/6HP, 120V AC	10A, 30V DC/ 240V AC 1/3HP, 240V AC 1/4HP, 120V AC
Silver-Nickel with gold plating	Silver-Nickel alloy	Silver-Nickel alloy	Silver-Cadmium Oxide	Silver
RU Series	RY/RM Series		RFIV Series	

Архив метки: [RU2S](#)  
[РЕЛЕ](#)

## IDEC РЕЛЕ

### IDEC реле

#### ru4s, ru2s

ru2s-d-d24 idec,  
ru2s-d24 idec,  
ru2s-a110 idec, relay plug-in dpdt 10a 120vac. мин.: 5 шт.  
ru2s-a220 idec, relay plug-in dpdt 10a 240vac. мин.: 5 шт.  
ru2s-c-a110 idec, relay plug-in dpdt 10a 120vac. мин.: 5 шт.  
ru2s-a110  
ru2s-a220  
ru2s-a24  
ru2s-c-a110  
ru2s-c-d-d24  
ru2s-d24  
ru2s-c-a220 idec  
ru2s-c-d24 idec, relay, dpdt, 240vac, 30vdc, 10a  
ru2s-d24 idec, relay, dpdt, 240vac, 30vdc, 10a  
ru2s-a110 idec  
ru2s-a110 idec, relay, dpdt, 240vac, 30vdc, 10a  
ru2s-a220 idec, relay, dpdt, 240vac, 30vdc, 10a  
ru2s-a220 idec  
ru2s-a24 idec  
ru2s-a24 idec, relay, dpdt, 240vac, 30vdc, 10a  
ru2s-c-a110 idec  
ru2s-c-a110 idec, power relay, dpdt, 110vac, 10a, plug in  
ru2s-c-d24 idec, relay, dpdt, 240vac, 30vdc, 10a  
ru2s-c-d-d24 idec  
ru2s-d110 idec pty ltd, relay, plug-in, dpdt, led  
ru2s-d24 idec, relay, dpdt, 240vac, 30vdc, 10a  
ru2s-d24 idec  
gp15aru-2s10/gp15a-b10 /gp batteries/ моq>10 gp batteries  
gp24aru-2s10/gp24a-b10 /gp batteries/ моq>10 gp batteries  
ru2s-a110 /idec corporation/ цена от 25 шт idec corporation  
ru2s-a110 /idec/ моq> 50 idec  
ru2s-a220 /idec corporation/ цена от 5 шт idec corporation  
ru2s-a220 /idec/ моq> 25 idec  
ru2s-a24 /idec corporation/ цена от 50 шт idec corporation  
ru2s-a24 /idec/ моq> 5 idec  
ru2s-c-a110 /idec corporation/ цена от 25 шт idec corporation  
ru2s-c-a110 /idec/ моq> 10 idec

ru2s-c-a220 /idec corporation/ цена от 5 шт idec corporation  
ru2s-c-a220 /idec/ idec  
ru2s-c-d110 /idec corporation/ цена от 3 шт idec corporation  
ru2s-c-d12 /idec corporation/ цена от 10 шт idec corporation  
ru2s-c-d12 /idec/ moq>2 idec  
ru2s-c-d24 /idec corporation/ цена от 100 шт idec corporation  
ru2s-c-d24 /idec/ moq> 50 idec  
ru2s-c-d24 /idec/ moq>2 idec  
ru2s-cd-d24 /idec corporation/ цена от 50 шт idec corporation  
ru2s-d-d24 /idec corporation/ цена от 100 шт idec corporation  
ru2s-d110 /idec corporation/ цена от 5 шт idec corporation  
ru2s-d12 /idec corporation/ цена от 50 шт idec corporation  
ru2s-d24 /idec corporation/ цена от 100 шт idec corporation  
ru2s-d24 /idec/ idec  
ru2s-d24 /idec/ moq> 50 idec  
ru2s-m-a110 /idec corporation/ цена от 10 шт idec corporation  
ru2s-m-d24 /idec corporation/ цена от 25 шт idec corporation  
ru2s-a220 idec  
ru2s-c-a110 idec  
ru2s-c-a220 idec  
ru2s-c-d12 idec  
ru2s-c-d24 idec  
ru2s-d24 idec  
ru2s-a110-120  
ru2s-a220-240  
ru2s-a24  
ru2s-c-a110  
ru2s-c-a220  
ru2s-c-a24  
ru2s-c-d110  
ru2s-c-d12  
ru2s-c-d24  
ru2s-d-d24  
ru2s-d110  
ru2s-d12  
ru2s-d24  
ru2s-m-a110  
ru2s-m-a220  
ru2s-m-a24  
ru2s-m-d110  
ru2s-m-d12  
ru2s-m-d24  
ru2sa110 idec  
ru2sa220 idec  
ru2sa24 idec  
ru2sca110 idec  
ru2sca220 idec  
ru2sca24 idec  
ru2scd110 idec  
ru2scd12 idec  
ru2scd24 idec  
ru2scdd24 idec  
ru2scra110 idec  
ru2sd110 idec  
ru2sd12 idec  
ru2sd24 idec  
ru2sdd24 idec  
ru2sma110 idec  
ru2sma220 idec  
ru2smd12 idec  
ru2smd24 idec  
acx1mr-u2-s-m black box, dkm hd video and peripheral matrix switch receiver modular interface cards, single-mode fiber, usb 2.0 extension board  
acx1mr-u2-s-m-w1 black box, 1 year warranty for acx1mr-u2-s-m  
acx1mr-u2-s-m-w3 black box, 3 year warranty for acx1mr-u2-s-m  
ru2s-a110 idec, power relay, dpdt, 110vac, 10a, plug in; product range:idec — ru series; coil voltage:110vac; contact current:10a; contact voltage vac:240v;  
contact voltage vdc:30v; contact configuration:dpdt; coil r  
ru2s-a110-120 idec  
ru2s-a220 idec, power relay, dpdt, 220vac, 10a, plug in; product range:idec — ru series; coil voltage:220vac; contact current:10a; contact voltage vac:240v;  
contact voltage vdc:30v; contact configuration:dpdt; coil r  
ru2s-a220-240 idec  
ru2s-a24 glenair  
ru2s-c-a110 glenair  
ru2s-c-a220 glenair  
ru2s-c-a24 idec  
ru2s-c-d110 glenair  
ru2s-c-d12 glenair  
ru2s-c-d24 glenair  
ru2s-d-d24 glenair  
ru2s-d110 glenair  
ru2s-d12 glenair  
ru2s-d24 glenair  
ru2s-m-a110 glenair  
ru2s-m-a220 idec  
ru2s-m-a24 glenair

Заказ г.Минск viber и тел. +375447584780 email: minsk17@tut.by

ru2s-m-d110 glenair  
ru2s-m-d12 glenair  
ru2s-m-d24 idec  
acx1mr-u2-sm black box, dkm hd video and peripheral matrix switch receiver modular interface cards, single-mode fiber, usb 2.0 extension board  
acx1mr-u2-s-m-w1 black box, 1 year warranty for acx1mr-u2-sm  
acx1mr-u2-s-m-w3 black box, 3 year warranty for acx1mr-u2-sm  
ru2s etc2 [list of unclassified manufacturers], series general purpose relay  
ru2s-a110 idec, relay, dpdt, 240vac, 30vdc, 10a; contact configuration:dpdt; coil voltage:110vac; contact current:10a; product range:ru series; relay mounting:socket; coil type:non latching; contact voltage vac:240va  
ru2s-a110-120 idec  
ru2s-a220 idec, relay, dpdt, 240vac, 30vdc, 10a; contact configuration:dpdt; coil voltage:220vac; contact current:10a; product range:ru series; relay mounting:socket; coil type:non latching; contact voltage vac:240va  
ru2s-a220-240 idec  
ru2s-a24 idec, relay, dpdt, 240vac, 30vdc, 10a; contact configuration:dpdt; coil voltage:24vac; contact current:10a; product range:ru series; relay mounting:socket; coil type:non latching; contact voltage vac:240vac  
ru2s-c etc2 [list of unclassified manufacturers], series general purpose relay  
ru2s-c-a110 etc2 [list of unclassified manufacturers], relay, dpdt, 240vac, 30vdc, 10a; contact configuration:dpdt; coil voltage:110vac; contact current:10a; product range:ru series; relay mounting:socket; coil type:non latching; contact voltage vac:240va  
ru2s-c-a220 idec, relay, dpdt, 240vac, 30vdc, 10a; contact configuration:dpdt; coil voltage:220vac; contact current:10a; product range:ru series; relay mounting:socket; coil type:non latching; contact voltage vac:240va  
ru2s-c-a24 idec, relay, dpdt, 240vac, 30vdc, 10a; contact configuration:dpdt; coil voltage:24vac; contact current:10a; product range:ru series; relay mounting:socket; coil type:non latching; contact voltage vac:240vac  
ru2s-c-d110 idec, relay, dpdt, 240vac, 30vdc, 10a; contact configuration:dpdt; coil voltage:110vdc; contact current:10a; product range:ru series; relay mounting:socket; coil type:non latching; contact voltage vac:240va  
ru2s-c-d12 idec, relay, dpdt, 240vac, 30vdc, 10a; contact configuration:dpdt; coil voltage:12vdc; contact current:10a; product range :ru series; relay mounting:socket; coil type:non latching; contact voltage vac:240vac  
ru2s-c-d24 etc2 [list of unclassified manufacturers], relay, dpdt, 240vac, 30vdc, 10a; contact configuration:dpdt; coil voltage:24vdc; contact current:10a; product range:ru series; relay mounting:socket; coil type:non latching; contact voltage vac:240vac  
ru2s-d-d24 glenair  
ru2s-d110 idec, relay, dpdt, 240vac, 30vdc, 10a; contact configuration:dpdt; coil voltage:110vdc; contact current:10a; product range:ru series; relay mounting:socket; coil type:non latching; contact voltage vac:240va  
ru2s-d12 idec, relay, dpdt, 240vac, 30vdc, 10a; contact configuration:dpdt; coil voltage:12vdc; contact current:10a; product range :ru series; relay mounting:socket; coil type:non latching; contact voltage vac:240vac  
ru2s-d24 idec, relay, dpdt, 240vac, 30vdc, 10a; contact configuration:dpdt; coil voltage:24vdc; contact current:10a; product range :ru series; relay mounting:socket; coil type:non latching; contact voltage vac:240vac  
ru2s-m etc2 [list of unclassified manufacturers], series general purpose relay  
ru2s-m-a110 glenair  
ru2s-m-a220 idec  
ru2s-m-a24 glenair  
ru2s-m-d110 glenair  
ru2s-m-d12 glenair  
ru2s-m-d24 idec  
ru2s-a220 idec corporation  
ru2s-c-a220 idec corporation  
ru2s-c-d12 idec corporation  
ru2s-cr-a110 idec corporation  
ru2s-d24 idec, relay, dpdt, 240vac, 30vdc, 10a  
acx1mr-u2-sm black box, dkm hd video and peripheral matrix switch receiver modular interface cards, single-mode fiber, usb 2.0 extension board  
acx1mr-u2-s-m-w1 black box, 1 year warranty for acx1mr-u2-sm  
acx1mr-u2-s-m-w3 black box, 3 year warranty for acx1mr-u2-sm  
ru2s-a110 idec, power relay, dpdt, 110vac, 10a, plug in; product range:idec — ru series; coil voltage:110vac; contact current:10a; contact voltage vac:240v; contact voltage vdc:30v; contact configuration:dpdt; coil r  
ru2s-a110-120 idec  
ru2s-a220 idec, power relay, dpdt, 220vac, 10a, plug in; product range:idec — ru series; coil voltage:220vac; contact current:10a; contact voltage vac:240v; contact voltage vdc:30v; contact configuration:dpdt; coil r  
ru2s-a220-240 idec  
ru2s-a24 idec, power relay, dpdt, 24vac, 10a, plug in; product range:idec — ru series; coil voltage:24vac; contact current:10a; contact voltage vac:240v; contact voltage vdc:30v; contact configuration:dpdt; coil res  
ru2s-c-a110 idec, power relay, dpdt, 110vac, 10a, plug in; product range:idec — ru series; coil voltage:110vac; contact current:10a; contact voltage vac:240v; contact voltage vdc:30v; contact configuration:dpdt; coil r  
ru2s-c-a220 idec, power relay, dpdt, 220vac, 10a, plug in; product range:idec — ru series; coil voltage:220vac; contact current:10a; contact voltage vac:240v; contact voltage vdc:30v; contact configuration:dpdt; coil r  
ru2s-c-a24 idec, power relay, dpdt, 24vac, 10a, plug in; product range:idec — ru series; coil voltage:24vac; contact current:10a; contact voltage vac:240v; contact voltage vdc:30v; contact configuration:dpdt; coil res  
ru2s-c-d110 idec, power relay, dpdt, 110vdc, 10a, plug in; product range:idec — ru series; coil voltage:110vdc; contact current:10a; contact voltage vac:240v; contact voltage vdc:30v; contact configuration:dpdt; coil r  
ru2s-c-d12 idec, power relay, dpdt, 12vdc, 10a, plug in; product range:idec — ru series; coil voltage:12vdc; contact current:10a; contact voltage vac:240v; contact voltage vdc:30v; contact configuration:dpdt; coil res  
ru2s-c-d24 idec, power relay, dpdt, 24vdc, 10a, plug in; product range:idec — ru series; coil voltage:24vdc; contact current:10a; contact voltage vac:240v; contact voltage vdc:30v; contact configuration:dpdt; coil res  
ru2s-d-d24 glenair  
ru2s-d110 idec, power relay, dpdt, 110vdc, 10a, plug in; product range:idec — ru series; coil voltage:110vdc; contact current:10a; contact voltage vac:240v; contact voltage vdc:30v; contact configuration:dpdt; coil r  
ru2s-d12 idec, power relay, dpdt, 12vdc, 10a, plug in; product range:idec — ru series; coil voltage:12vdc; contact current:10a; contact voltage vac:240v; contact voltage vdc:30v; contact configuration:dpdt; coil res  
ru2s-d24 idec, power relay, dpdt, 24vdc, 10a, plug in; product range:idec — ru series; coil voltage:24vdc; contact current:10a; contact voltage vac:240v; contact voltage vdc:30v; contact configuration:dpdt; coil res  
ru2s-m-a110 glenair  
ru2s-m-a220 idec  
ru2s-m-a24 glenair  
ru2s-m-d110 glenair  
ru2s-m-d12 glenair  
ru2s-m-d24 idec

ru4s-c-a110 idec, relay plug-in 4pdt 6a 120vac. мин.: 5шт.  
ru4s-c-d110 idec, relay plug-in 4pdt 6a 110vdc. мин.: 5шт.  
ru4s-c-d24 idec, relay plug-in 4pdt 6a 24vdc. мин.: 5шт.  
ru4s-d24 idec, relay plug-in 4pdt 6a 24vdc. мин.: 5шт.  
ru4s-a110  
ru4s-a24  
ru4s-c-a110  
ru4s-c-a220  
ru4s-c-a24  
ru4s-c-d110  
ru4s-c-d24  
ru4s-cd-d24  
ru4s-d-d24  
ru4s-d110  
ru4s-d24  
ru4s-m-a110  
ru4s-m-a24  
ru4s-m-d110  
ru4s-m-d24  
ru4s-c-a220 idec  
ru4s-c-d24 idec, relay, 4pdt, 240vac, 30vdc, 6a  
ru4s-cd-d24 idec, power relay, 24vdc, 6a, 4pdt, socket  
ru4s-d24 idec, relay, 4pdt, 240vac, 30vdc, 6a  
ru4s-a110 idec  
ru4s-a110 idec, relay, 4pdt, 240vac, 30vdc, 6a  
ru4s-a110 idec pty ltd, relay, plug-in, 4pdt, led  
ru4s-a24 idec, relay, 4pdt, 240vac, 30vdc, 6a  
ru4s-a24 idec  
ru4s-c-a110 idec, relay, 4pdt, 240vac, 30vdc, 6a  
ru4s-c-a110 idec  
ru4s-c-a220 idec  
ru4s-c-a24 idec  
ru4s-c-a24 idec, relay, 4pdt, 240vac, 30vdc, 6a  
ru4s-c-d110 idec  
ru4s-c-d24 idec, relay, 4pdt, 240vac, 30vdc, 6a  
ru4s-c-d24 idec  
ru4s-cd-d24 idec  
ru4s-cd-d24 idec, power relay, 24vdc, 6a, 4pdt, socket  
ru4s-d-d24 idec  
ru4s-d110 idec  
ru4s-d12 idec, relay, 4pdt, 240vac, 30vdc, 6a  
ru4s-d24 idec  
ru4s-d24 idec, relay, 4pdt, 24vdc, 6a, socket  
ru4s-m-a110 idec  
ru4s-m-a24 idec  
ru4s-m-d110 idec  
ru4s-m-d24 idec  
ru4s-a110 /idec corporation/ цена от 100 шт idec corporation  
ru4s-a110 /idec/ моq> 100 idec  
ru4s-a220 /idec corporation/ цена от 100 шт idec corporation  
ru4s-a24 /idec corporation/ цена от 100 шт idec corporation  
ru4s-a24 /idec/ моq> 100 idec  
ru4s-c-a110 /idec corporation/ цена от 100 шт idec corporation  
ru4s-c-a110 /idec/ моq> 100 idec  
ru4s-c-a220 /idec corporation/ цена от 250 шт idec corporation  
ru4s-c-a220 /idec/ моq>2 idec  
ru4s-c-a24 /idec corporation/ цена от 25 шт idec corporation  
ru4s-c-a24 /idec/ моq> 50 idec  
ru4s-c-d110 /idec corporation/ цена от 50 шт idec corporation  
ru4s-c-d12 /idec corporation/ цена от 50 шт idec corporation  
ru4s-c-d24 /idec corporation/ цена от 100 шт idec corporation  
ru4s-c-d24 /idec/ моq> 50 idec  
ru4s-c-d24 /idec/ моq>2 idec  
ru4s-cd-d24 /idec corporation/ цена от 50 шт idec corporation  
ru4s-cd-d24 /idec/ моq> 25 idec  
ru4s-cd-d24 /idec/ моq>2 idec  
ru4s-d-d24 /idec corporation/ цена от 100 шт idec corporation  
ru4s-d110 /idec corporation/ цена от 50 шт idec corporation  
ru4s-d12 /idec corporation/ цена от 50 шт idec corporation  
ru4s-d12 /idec/ моq> 25 idec  
ru4s-d24 /idec corporation/ цена от 25 шт idec corporation  
ru4s-d24 /idec/ моq> 100 idec  
ru4s-d24 /idec/ моq>2 idec  
ru4s-m-a110 /idec corporation/ цена от 1 шт idec corporation  
ru4s-m-a24 /idec corporation/ цена от 5 шт idec corporation  
ru4s-m-d110 /idec corporation/ цена от 50 шт idec corporation  
ru4s-m-d12 /idec corporation/ цена от 10 шт idec corporation  
ru4s-m-d24 /idec corporation/ цена от 50 шт idec corporation  
ru4s-a24 idec  
ru4s-c-a220 idec  
ru4s-c-d24 idec  
ru4s-cd-d24 idec  
ru4s-d-d24 idec  
ru4s-d24 idec

ru4s-a110-120  
ru4s-a220-240  
ru4s-a24  
ru4s-c-a110  
ru4s-c-a220  
ru4s-c-a24  
ru4s-c-d110  
ru4s-c-d12  
ru4s-c-d24  
ru4s-d-d24  
ru4s-d110  
ru4s-d12  
ru4s-d24  
ru4s-m-a110  
ru4s-m-a220  
ru4s-m-a24  
ru4s-m-d110  
ru4s-m-d12  
ru4s-m-d24  
ru4sa110 idec  
ru4sa220 idec  
ru4sa24 idec  
ru4sca110 idec  
ru4sca220 idec  
ru4sca24 idec  
ru4scd110 idec  
ru4scd12 idec  
ru4scd24 idec  
ru4scdd12 idec  
ru4scdd24 idec  
ru4sd110 idec  
ru4sd12 idec  
ru4sd24 idec  
ru4sdd12 idec  
ru4sdd24 idec  
ru4sma110 idec  
ru4sma24 idec  
ru4smd110 idec  
ru4smd12 idec  
ru4smd24 idec  
ru4s-a110 idec, power relay, 4pdt, 110vac, 6a, plug in; product range:idec — ru series; coil voltage:110vac; contact current:6a; contact voltage vac:240v; contact voltage vdc:30v; contact configuration:4pdt; coil res  
ru4s-a110-120 idec  
ru4s-a220 idec, power relay, 4pdt, 220vac, 6a, plug in; product range:idec — ru series; coil voltage:220vac; contact current:6a; contact voltage vac:240v; contact voltage vdc:30v; contact configuration:4pdt; coil res  
ru4s-a220-240 glenair  
ru4s-a24 glenair  
ru4s-c-a110 glenair  
ru4s-c-a220 glenair  
ru4s-c-a24 glenair  
ru4s-c-d110 glenair  
ru4s-c-d12 glenair  
ru4s-c-d24 glenair  
ru4s-d-d24 glenair  
ru4s-d110 glenair  
ru4s-d12 glenair  
ru4s-d24 idec  
ru4s-m-a110 idec  
ru4s-m-a220 glenair  
ru4s-m-a24 glenair  
ru4s-m-d110 idec  
ru4s-m-d12 glenair  
ru4s-m-d24 glenair  
ru4s etc2 [list of unclassified manufacturers], series general purpose relay  
ru4s-a110 idec, relay, 4pdt, 240vac, 30vdc, 6a; contact configuration:4pdt; coil voltage:110vac; contact current:6a; product range:ru series; relay mounting:socket; coil type:non latching; contact voltage vac:240vac;  
ru4s-a110-120 idec  
ru4s-a220 idec, relay, 4pdt, 240vac, 30vdc, 6a; contact configuration:4pdt; coil voltage:220vac; contact current:6a; product range:ru series; relay mounting:socket; coil type:non latching; contact voltage vac:240vac;  
ru4s-a220-240 glenair  
ru4s-a24 idec, relay, 4pdt, 240vac, 30vdc, 6a; contact configuration:4pdt; coil voltage:24vac; contact current:6a; product range:ru series; relay mounting:socket; coil type:non latching; contact voltage vac:240vac;  
ru4s-c etc2 [list of unclassified manufacturers], series general purpose relay  
ru4s-c-a110 idec, relay, 4pdt, 240vac, 30vdc, 6a; contact configuration:4pdt; coil voltage:110vac; contact current:6a; product range:ru series; relay mounting:socket; coil type:non latching; contact voltage vac:240vac;  
ru4s-c-a220 idec, relay, 4pdt, 240vac, 30vdc, 6a; contact configuration:4pdt; coil voltage:220vac; contact current:6a; product range:ru series; relay mounting:socket; coil type:non latching; contact voltage vac:240vac;  
ru4s-c-a24 idec, relay, 4pdt, 240vac, 30vdc, 6a; contact configuration:4pdt; coil voltage:24vac; contact current:6a; product range:ru series; relay mounting:socket; coil type:non latching; contact voltage vac:240vac;  
ru4s-c-d110 idec, relay, 4pdt, 240vac, 30vdc, 6a; contact configuration:4pdt; coil voltage:110vdc; contact current:6a; product range:ru series; relay mounting:socket; coil type:non latching; contact voltage vac:240vac;  
ru4s-c-d12 idec, relay, 4pdt, 240vac, 30vdc, 6a; contact configuration:4pdt; coil voltage:12vdc; contact current:6a; product range:ru series; relay mounting:socket; coil type:non latching; contact voltage vac:240vac;  
ru4s-c-d24 idec, relay, 4pdt, 240vac, 30vdc, 6a; contact configuration:4pdt; coil voltage:24vdc; contact current:6a; product range:ru series; relay

Заказ в Минске вiber и тел. +375447584780 Email: minsk17@tut.by

mounting:socket; coil type:non latching; contact voltage vac:240vac;  
ru4s-cd-d24 etc2 [list of unclassified manufacturers], series universal relay  
ru4s-d-d24 glenair  
ru4s-d110 glenair  
ru4s-d12 idec, relay, 4pdt, 240vac, 30vdc, 6a; contact configuration:4pdt; coil voltage:12vdc; contact current:6a; product range:ru series; relay  
mounting:socket; coil type:non latching; contact voltage vac:240vac;  
ru4s-d24 idec, relay, 4pdt, 240vac, 30vdc, 6a; contact configuration:4pdt; coil voltage:24vdc; contact current:6a; product range:ru series; relay  
mounting:socket; coil type:non latching; contact voltage vac:240vac;  
ru4s-m etc2 [list of unclassified manufacturers], series general purpose relay  
ru4s-m-a110 idec  
ru4s-m-a220 glenair  
ru4s-m-a24 glenair  
ru4s-m-d110 idec  
ru4s-m-d12 glenair  
ru4s-m-d24 glenair  
ru4s-c-d12 idec corporation  
ru4s-cd-d12 idec corporation  
ru4s-d12 idec corporation  
ru4s-d24 idec, relay, 4pdt, 24vdc, 6a, socket  
ru4s-md-d110 idec corporation  
ru4s-a110 idec, power relay, 4pdt, 110vac, 6a, plug in; product range:idec — ru series; coil voltage:110vac; contact current:6a; contact voltage vac:240v;  
contact voltage vdc:30v; contact configuration:4pdt; coil res  
ru4s-a110-120 idec  
ru4s-a220 idec, power relay, 4pdt, 220vac, 6a, plug in; product range:idec — ru series; coil voltage:220vac; contact current:6a; contact voltage vac:240v;  
contact voltage vdc:30v; contact configuration:4pdt; coil res  
ru4s-a220-240 glenair  
ru4s-a24 idec, power relay, 4pdt, 24vac, 6a, plug in; product range:idec — ru series; coil voltage:24vac; contact current:6a; contact voltage vac:240v;  
contact voltage vdc:30v; contact configuration:4pdt; coil res  
ru4s-c-a110 idec, power relay, 4pdt, 110vac, 6a, plug in; product range:idec — ru series; coil voltage:110vac; contact current:6a; contact voltage vac:240v;  
contact voltage vdc:30v; contact configuration:4pdt; coil res  
ru4s-c-a220 idec, power relay, 4pdt, 220vac, 6a, plug in; product range:idec — ru series; coil voltage:220vac; contact current:6a; contact voltage vac:240v;  
contact voltage vdc:30v; contact configuration:4pdt; coil res  
ru4s-c-a24 idec, power relay, 4pdt, 24vac, 6a, plug in; product range:idec — ru series; coil voltage:24vac; contact current:6a; contact voltage vac:240v;  
contact voltage vdc:30v; contact configuration:4pdt; coil res  
ru4s-c-d110 idec, power relay, 4pdt, 110vdc, 6a, plug in; product range:idec — ru series; coil voltage:110vdc; contact current:6a; contact voltage vac:240v;  
contact voltage vdc:30v; contact configuration:4pdt; coil res  
ru4s-c-d12 idec, power relay, 4pdt, 12vdc, 6a, plug in; product range:idec — ru series; coil voltage:12vdc; contact current:6a; contact voltage vac:240v;  
contact voltage vdc:30v; contact configuration:4pdt; coil res  
ru4s-c-d24 idec, power relay, 4pdt, 24vdc, 6a, plug in; product range:idec — ru series; coil voltage:24vdc; contact current:6a; contact voltage vac:240v;  
contact voltage vdc:30v; contact configuration:4pdt; coil res  
ru4s-d-d24 glenair  
ru4s-d110 glenair  
ru4s-d12 idec, power relay, 4pdt, 12vdc, 6a, plug in; product range:idec — ru series; coil voltage:12vdc; contact current:6a; contact voltage vac:240v;  
contact voltage vdc:30v; contact configuration:4pdt; coil res  
ru4s-d24 idec, power relay, 4pdt, 24vdc, 6a, plug in; product range:idec — ru series; coil voltage:24vdc; contact current:6a; contact voltage vac:240v;  
contact voltage vdc:30v; contact configuration:4pdt; coil res  
ru4s-m-a110 idec  
ru4s-m-a220 glenair  
ru4s-m-a24 glenair  
ru4s-m-d110 idec  
ru4s-m-d12 glenair  
ru4s-m-d24 glenair

IDECRU2SRU4SPEIE

РЕЛЕ СЛЮБЫЕ

## IDEC РЕЛЕ RU2S, RU4S

23.11.2018

### идеc реле ru2s, ru4s

datasheet, даташит, [каталог скачать>>>](#)

ru2s-a110  
ru2s-a220  
ru2s-a24  
ru2s-c-a110  
ru2s-cd-d24  
ru2s-d24  
ru2s-d-d24 idec,  
ru2s-d24 idec,  
ru2s-a110 idec, relay plug-in dpdt 10a 120vac. мин.: 5шт.  
ru2s-a220 idec, relay plug-in dpdt 10a 240vac. мин.: 5шт.  
ru2s-c-a110 idec, relay plug-in dpdt 10a 120vac. мин.: 5шт.  
ru2s-a110-120  
ru2s-a220-240  
ru2s-a24  
ru2s-c-a110  
ru2s-c-a220  
ru2s-c-a24  
ru2s-c-d110  
ru2s-c-d12  
ru2s-c-d24

**Минск +375447584780 Viber email [minsk17@tut.by](mailto:minsk17@tut.by)**

ru2s-d-d24  
ru2s-d110  
ru2s-d12  
ru2s-d24  
ru2s-m-a110  
ru2s-m-a220  
ru2s-m-a24  
ru2s-m-d110  
ru2s-m-d12  
ru2s-m-d24  
ru2s-c-a220 idec  
ru2s-c-d24 idec, relay, dpdt, 240vac, 30vdc, 10a  
ru2s-d24 idec, relay, dpdt, 240vac, 30vdc, 10a  
gp15aru-2s10/gp15a-b10 /gp batteries/ моq>10 gp batteries  
gp24aru-2s10/gp24a-b10 /gp batteries/ моq>10 gp batteries  
ru2s-a110 /idec corporation/ цена от 25 шт idec corporation  
ru2s-a110 /idec/ моq> 50 idec  
ru2s-a220 /idec corporation/ цена от 5 шт idec corporation  
ru2s-a220 /idec/ моq> 25 idec  
ru2s-a24 /idec corporation/ цена от 50 шт idec corporation  
ru2s-a24 /idec/ моq> 5 idec  
ru2s-c-a110 /idec corporation/ цена от 25 шт idec corporation  
ru2s-c-a110 /idec/ моq> 10 idec  
ru2s-c-a220 /idec corporation/ цена от 5 шт idec corporation  
ru2s-c-a220 /idec/ idec  
ru2s-c-d110 /idec corporation/ цена от 3 шт idec corporation  
ru2s-c-d12 /idec corporation/ цена от 10 шт idec corporation  
ru2s-c-d12 /idec/ моq>2 idec  
ru2s-c-d24 /idec corporation/ цена от 100 шт idec corporation  
ru2s-c-d24 /idec/ моq> 50 idec  
ru2s-c-d24 /idec/ моq>2 idec  
ru2s-cd-d24 /idec corporation/ цена от 50 шт idec corporation  
ru2s-d-d24 /idec corporation/ цена от 100 шт idec corporation  
ru2s-d110 /idec corporation/ цена от 5 шт idec corporation  
ru2s-d12 /idec corporation/ цена от 50 шт idec corporation  
ru2s-d24 /idec corporation/ цена от 100 шт idec corporation  
ru2s-d24 /idec/ idec  
ru2s-d24 /idec/ моq> 50 idec  
ru2s-m-a110 /idec corporation/ цена от 10 шт idec corporation  
ru2s-m-d24 /idec corporation/ цена от 25 шт idec corporation  
ru2s-a110 idec, relay, dpdt, 240vac, 30vdc, 10a  
ru2s-a110 idec  
ru2s-a220 idec, relay, dpdt, 240vac, 30vdc, 10a  
ru2s-a220 idec  
ru2s-a24 idec  
ru2s-a24 idec, relay, dpdt, 240vac, 30vdc, 10a  
ru2s-c-a110 idec  
ru2s-c-a110 idec, power relay, dpdt, 110vac, 10a, plug in  
ru2s-c-d24 idec, relay, dpdt, 240vac, 30vdc, 10a  
ru2s-cd-d24 idec  
ru2s-d110 idec pty ltd, relay, plug-in, dpdt, led  
ru2s-d24 idec  
ru2s-d24 idec, relay, dpdt, 240vac, 30vdc, 10a  
ru2s-a220 idec  
ru2s-c-a110 idec  
ru2s-c-a220 idec  
ru2s-c-d12 idec  
ru2s-c-d24 idec  
ru2s-d24 idec  
acx1mr-u2-s m black box, dkm hd video and peripheral matrix switch receiver modular interface cards, single-mode fiber, usb 2.0 extension board  
acx1mr-u2-s m-w1 black box, 1 year warranty for acx1mr-u2-s m  
acx1mr-u2-s m-w3 black box, 3 year warranty for acx1mr-u2-s m  
ru2s etc2 [list of unclassified manufacturers], series general purpose relay  
ru2s-a110 idec, relay, dpdt, 240vac, 30vdc, 10a; contact configuration:dpdt; coil voltage:110vac; contact current:10a; product range:ru series; relay mounting:socket; coil type:non latching; contact voltage vac:240va  
ru2s-a110-120 idec  
ru2s-a220 idec, relay, dpdt, 240vac, 30vdc, 10a; contact configuration:dpdt; coil voltage:220vac; contact current:10a; product range:ru series; relay mounting:socket; coil type:non latching; contact voltage vac:240va  
ru2s-a220-240 idec  
ru2s-a24 idec, relay, dpdt, 240vac, 30vdc, 10a; contact configuration:dpdt; coil voltage:24vac; contact current:10a; product range:ru series; relay mounting:socket; coil type:non latching; contact voltage vac:240vac  
ru2s-c etc2 [list of unclassified manufacturers], series general purpose relay  
ru2s-c-a110 etc2 [list of unclassified manufacturers], relay, dpdt, 240vac, 30vdc, 10a; contact configuration:dpdt; coil voltage:110vac; contact current:10a; product range:ru series; relay mounting:socket; coil type:non latching; contact voltage vac:240va  
ru2s-c-a220 idec, relay, dpdt, 240vac, 30vdc, 10a; contact configuration:dpdt; coil voltage:220vac; contact current:10a; product range:ru series; relay mounting:socket; coil type:non latching; contact voltage vac:240va  
ru2s-c-a24 idec, relay, dpdt, 240vac, 30vdc, 10a; contact configuration:dpdt; coil voltage:24vac; contact current:10a; product range:ru series; relay mounting:socket; coil type:non latching; contact voltage vac:240vac  
ru2s-c-d110 idec, relay, dpdt, 240vac, 30vdc, 10a; contact configuration:dpdt; coil voltage:110vdc; contact current:10a; product range:ru series; relay mounting:socket; coil type:non latching; contact voltage vac:240va  
ru2s-c-d12 idec, relay, dpdt, 240vac, 30vdc, 10a; contact configuration:dpdt; coil voltage:12vdc; contact current:10a; product range:ru series; relay mounting:socket; coil type:non latching; contact voltage vac:240vac  
ru2s-c-d24 etc2 [list of unclassified manufacturers], relay, dpdt, 240vac, 30vdc, 10a; contact configuration:dpdt; coil voltage:24vdc; contact current:10a; product range:ru series; relay mounting:socket; coil type:non latching; contact voltage vac:240vac

ru2s-d-d24 glenair  
ru2s-d110 idec, relay, dpdt, 240vac, 30vdc, 10a; contact configuration:dpdt; coil voltage:110vdc; contact current:10a; product range:ru series; relay mounting:socket; coil type:non latching; contact voltage vac:240va  
ru2s-d12 idec, relay, dpdt, 240vac, 30vdc, 10a; contact configuration:dpdt; coil voltage:12vdc; contact current:10a; product range:ru series; relay mounting:socket; coil type:non latching; contact voltage vac:240vac  
ru2s-d24 idec, relay, dpdt, 240vac, 30vdc, 10a; contact configuration:dpdt; coil voltage:24vdc; contact current:10a; product range:ru series; relay mounting:socket; coil type:non latching; contact voltage vac:240vac  
ru2s-m etc2 [list of unclassified manufacturers], series general purpose relay  
ru2s-m-a110 glenair  
ru2s-m-a220 idec  
ru2s-m-a24 glenair  
ru2s-m-d110 glenair  
ru2s-m-d12 glenair  
ru2s-m-d24 idec  
ru2sa110 idec  
ru2sa220 idec  
ru2sa24 idec  
ru2sca110 idec  
ru2sca220 idec  
ru2sca24 idec  
ru2scd110 idec  
ru2scd12 idec  
ru2scd24 idec  
ru2scdd24 idec  
ru2scra110 idec  
ru2sd110 idec  
ru2sd12 idec  
ru2sd24 idec  
ru2sd24 idec  
ru2sma110 idec  
ru2sma220 idec  
ru2smd12 idec  
ru2smd24 idec  
acx1mr-u2-sm black box, dkm hd video and peripheral matrix switch receiver modular interface cards, single-mode fiber, usb 2.0 extension board  
acx1mr-u2-s-m-w1 black box, 1 year warranty for acx1mr-u2-sm  
acx1mr-u2-s-m-w3 black box, 3 year warranty for acx1mr-u2-sm  
ru2s-a110 idec, power relay, dpdt, 110vac, 10a, plug in; product range:idec — ru series; coil voltage:110vac; contact current:10a; contact voltage vac:240v; contact voltage vdc:30v; contact configuration:dpdt; coil r  
ru2s-a110-120 idec  
ru2s-a220 idec, power relay, dpdt, 220vac, 10a, plug in; product range:idec — ru series; coil voltage:220vac; contact current:10a; contact voltage vac:240v; contact voltage vdc:30v; contact configuration:dpdt; coil r  
ru2s-a220-240 idec  
ru2s-a24 glenair  
ru2s-c-a110 glenair  
ru2s-c-a220 glenair  
ru2s-c-a24 idec  
ru2s-c-d110 glenair  
ru2s-c-d12 glenair  
ru2s-c-d24 glenair  
ru2s-d-d24 glenair  
ru2s-d110 glenair  
ru2s-d12 glenair  
ru2s-d24 glenair  
ru2s-m-a110 glenair  
ru2s-m-a220 idec  
ru2s-m-a24 glenair  
ru2s-m-d110 glenair  
ru2s-m-d12 glenair  
ru2s-m-d24 idec  
ru2s-a220 idec corporation  
ru2s-c-a220 idec corporation  
ru2s-c-d12 idec corporation  
ru2s-cr-a110 idec corporation  
ru2s-d24 idec, relay, dpdt, 240vac, 30vdc, 10a  
acx1mr-u2-sm black box, dkm hd video and peripheral matrix switch receiver modular interface cards, single-mode fiber, usb 2.0 extension board  
acx1mr-u2-s-m-w1 black box, 1 year warranty for acx1mr-u2-sm  
acx1mr-u2-s-m-w3 black box, 3 year warranty for acx1mr-u2-sm  
ru2s-a110 idec, power relay, dpdt, 110vac, 10a, plug in; product range:idec — ru series; coil voltage:110vac; contact current:10a; contact voltage vac:240v; contact voltage vdc:30v; contact configuration:dpdt; coil r  
ru2s-a110-120 idec  
ru2s-a220 idec, power relay, dpdt, 220vac, 10a, plug in; product range:idec — ru series; coil voltage:220vac; contact current:10a; contact voltage vac:240v; contact voltage vdc:30v; contact configuration:dpdt; coil r  
ru2s-a220-240 idec  
ru2s-a24 idec, power relay, dpdt, 24vac, 10a, plug in; product range:idec — ru series; coil voltage:24vac; contact current:10a; contact voltage vac:240v; contact voltage vdc:30v; contact configuration:dpdt; coil res  
ru2s-c-a110 idec, power relay, dpdt, 110vac, 10a, plug in; product range:idec — ru series; coil voltage:110vac; contact current:10a; contact voltage vac:240v; contact voltage vdc:30v; contact configuration:dpdt; coil r  
ru2s-c-a220 idec, power relay, dpdt, 220vac, 10a, plug in; product range:idec — ru series; coil voltage:220vac; contact current:10a; contact voltage vac:240v; contact voltage vdc:30v; contact configuration:dpdt; coil r  
ru2s-c-a24 idec, power relay, dpdt, 24vac, 10a, plug in; product range:idec — ru series; coil voltage:24vac; contact current:10a; contact voltage vac:240v; contact voltage vdc:30v; contact configuration:dpdt; coil res  
ru2s-c-d110 idec, power relay, dpdt, 110vdc, 10a, plug in; product range:idec — ru series; coil voltage:110vdc; contact current:10a; contact voltage vac:240v; contact voltage vdc:30v; contact configuration:dpdt; coil r  
ru2s-c-d12 idec, power relay, dpdt, 12vdc, 10a, plug in; product range:idec — ru series; coil voltage:12vdc; contact current:10a; contact voltage vac:240v;



contact voltage vdc:30v; contact configuration:dpdt; coil res  
ru2s-c-d24 idec, power relay, dpdt, 24vdc, 10a, plug in; product range:idec — ru series; coil voltage:24vdc; contact current:10a; contact voltage vac:240v;  
contact voltage vdc:30v; contact configuration:dpdt; coil res  
ru2s-d-d24 glenair  
ru2s-d110 idec, power relay, dpdt, 110vdc, 10a, plug in; product range:idec — ru series; coil voltage:110vdc; contact current:10a; contact voltage  
vac:240v; contact voltage vdc:30v; contact configuration:dpdt; coil r  
ru2s-d12 idec, power relay, dpdt, 12vdc, 10a, plug in; product range:idec — ru series; coil voltage:12vdc; contact current:10a; contact voltage vac:240v;  
contact voltage vdc:30v; contact configuration:dpdt; coil res  
ru2s-d24 idec, power relay, dpdt, 24vdc, 10a, plug in; product range:idec — ru series; coil voltage:24vdc; contact current:10a; contact voltage vac:240v;  
contact voltage vdc:30v; contact configuration:dpdt; coil res  
ru2s-m-a110 glenair  
ru2s-m-a220 idec  
ru2s-m-a24 glenair  
ru2s-m-d110 glenair  
ru2s-m-d12 glenair  
ru2s-m-d24 idec

ru4s-a110

ru4s-a24

ru4s-c-a110

ru4s-c-a220

ru4s-c-a24

ru4s-c-d110

ru4s-c-d24

ru4s-cd-d24

ru4s-d-d24

ru4s-d110

ru4s-d24

ru4s-m-a110

ru4s-m-a24

ru4s-m-d110

ru4s-m-d24

ru4s-c-a110 idec, relay plug-in 4pdt 6a 120vac. мин.: 5шт.

ru4s-c-d110 idec, relay plug-in 4pdt 6a 110vdc. мин.: 5шт.

ru4s-c-d24 idec, relay plug-in 4pdt 6a 24vdc. мин.: 5шт.

ru4s-d24 idec, relay plug-in 4pdt 6a 24vdc. мин.: 5шт.

ru4s-a110-120

ru4s-a220-240

ru4s-a24

ru4s-c-a110

ru4s-c-a220

ru4s-c-a24

ru4s-c-d110

ru4s-c-d12

ru4s-c-d24

ru4s-d-d24

ru4s-d110

ru4s-d12

ru4s-d24

ru4s-m-a110

ru4s-m-a220

ru4s-m-a24

ru4s-m-d110

ru4s-m-d12

ru4s-m-d24

ru4s-c-a220 idec

ru4s-c-d24 idec, relay, 4pdt, 240vac, 30vdc, 6a

ru4s-cd-d24 idec, power relay, 24vdc, 6a, 4pdt, socket

ru4s-d24 idec, relay, 4pdt, 240vac, 30vdc, 6a

ru4s-a110 /idec corporation/ цена от 100 шт idec corporation

ru4s-a110 /idec/ моq> 100 idec

ru4s-a220 /idec corporation/ цена от 100 шт idec corporation

ru4s-a24 /idec corporation/ цена от 100 шт idec corporation

ru4s-a24 /idec/ моq> 100 idec

ru4s-c-a110 /idec corporation/ цена от 100 шт idec corporation

ru4s-c-a110 /idec/ моq> 100 idec

ru4s-c-a220 /idec corporation/ цена от 250 шт idec corporation

ru4s-c-a220 /idec/ моq>2 idec

ru4s-c-a24 /idec corporation/ цена от 25 шт idec corporation

ru4s-c-a24 /idec/ моq> 50 idec

ru4s-c-d110 /idec corporation/ цена от 50 шт idec corporation

ru4s-c-d12 /idec corporation/ цена от 50 шт idec corporation

ru4s-c-d24 /idec corporation/ цена от 100 шт idec corporation

ru4s-c-d24 /idec/ моq> 50 idec

ru4s-c-d24 /idec/ моq>2 idec

ru4s-cd-d24 /idec corporation/ цена от 50 шт idec corporation

ru4s-cd-d24 /idec/ моq> 25 idec

ru4s-cd-d24 /idec/ моq>2 idec

ru4s-d-d24 /idec corporation/ цена от 100 шт idec corporation

ru4s-d110 /idec corporation/ цена от 50 шт idec corporation

ru4s-d12 /idec corporation/ цена от 50 шт idec corporation

ru4s-d12 /idec/ моq> 25 idec

ru4s-d24 /idec corporation/ цена от 25 шт idec corporation

ru4s-d24 /idec/ моq> 100 idec

ru4s-d24 /idec/ moq>5 idec  
ru4s-m-a110 /idec corporation/ цена от 1 шт idec corporation  
ru4s-m-a24 /idec corporation/ цена от 5 шт idec corporation  
ru4s-m-d110 /idec corporation/ цена от 50 шт idec corporation  
ru4s-m-d12 /idec corporation/ цена от 10 шт idec corporation  
ru4s-m-d24 /idec corporation/ цена от 50 шт idec corporation  
ru4s-a110 idec, relay, 4pdt, 240vac, 30vdc, 6a  
ru4s-a110 idec pty ltd, relay, plug-in, 4pdt, led  
ru4s-a110 idec  
ru4s-a24 idec  
ru4s-a24 idec, relay, 4pdt, 240vac, 30vdc, 6a  
ru4s-c-a110 idec, relay, 4pdt, 240vac, 30vdc, 6a  
ru4s-c-a110 idec  
ru4s-c-a220 idec  
ru4s-c-a24 idec, relay, 4pdt, 240vac, 30vdc, 6a  
ru4s-c-a24 idec  
ru4s-c-d110 idec  
ru4s-c-d24 idec  
ru4s-c-d24 idec, relay, 4pdt, 240vac, 30vdc, 6a  
ru4s-cd-d24 idec, power relay, 24vdc, 6a, 4pdt, socket  
ru4s-cd-d24 idec  
ru4s-d-d24 idec  
ru4s-d110 idec  
ru4s-d12 idec, relay, 4pdt, 240vac, 30vdc, 6a  
ru4s-d24 idec  
ru4s-d24 idec, relay, 4pdt, 24vdc, 6a, socket  
ru4s-m-a110 idec  
ru4s-m-a24 idec  
ru4s-m-d110 idec  
ru4s-m-d24 idec  
ru4s-a24 idec  
ru4s-c-a220 idec  
ru4s-c-d24 idec  
ru4s-cd-d24 idec  
ru4s-d-d24 idec  
ru4s-d24 idec  
ru4s etc2 [list of unclassified manufacturers], series general purpose relay  
ru4s-a110 idec, relay, 4pdt, 240vac, 30vdc, 6a; contact configuration:4pdt; coil voltage:110vac; contact current:6a; product range:ru series; relay mounting:socket; coil type:non latching; contact voltage vac:240vac;  
ru4s-a110-120 idec  
ru4s-a220 idec, relay, 4pdt, 240vac, 30vdc, 6a; contact configuration:4pdt; coil voltage:220vac; contact current:6a; product range:ru series; relay mounting:socket; coil type:non latching; contact voltage vac:240vac;  
ru4s-a220-240 glenair  
ru4s-a24 idec, relay, 4pdt, 240vac, 30vdc, 6a; contact configuration:4pdt; coil voltage:24vac; contact current:6a; product range:ru series; relay mounting:socket; coil type:non latching; contact voltage vac:240vac;  
ru4s-c etc2 [list of unclassified manufacturers], series general purpose relay  
ru4s-c-a110 idec, relay, 4pdt, 240vac, 30vdc, 6a; contact configuration:4pdt; coil voltage:110vac; contact current:6a; product range:ru series; relay mounting:socket; coil type:non latching; contact voltage vac:240vac;  
ru4s-c-a220 idec, relay, 4pdt, 240vac, 30vdc, 6a; contact configuration:4pdt; coil voltage:220vac; contact current:6a; product range:ru series; relay mounting:socket; coil type:non latching; contact voltage vac:240vac;  
ru4s-c-a24 idec, relay, 4pdt, 240vac, 30vdc, 6a; contact configuration:4pdt; coil voltage:24vac; contact current:6a; product range:ru series; relay mounting:socket; coil type:non latching; contact voltage vac:240vac;  
ru4s-c-d110 idec, relay, 4pdt, 240vac, 30vdc, 6a; contact configuration:4pdt; coil voltage:110vdc; contact current:6a; product range:ru series; relay mounting:socket; coil type:non latching; contact voltage vac:240vac;  
ru4s-c-d12 idec, relay, 4pdt, 240vac, 30vdc, 6a; contact configuration:4pdt; coil voltage:12vdc; contact current:6a; product range:ru series; relay mounting:socket; coil type:non latching; contact voltage vac:240vac;  
ru4s-c-d24 idec, relay, 4pdt, 240vac, 30vdc, 6a; contact configuration:4pdt; coil voltage:24vdc; contact current:6a; product range:ru series; relay mounting:socket; coil type:non latching; contact voltage vac:240vac;  
ru4s-cd-d24 etc2 [list of unclassified manufacturers], series universal relay  
ru4s-d-d24 glenair  
ru4s-d110 glenair  
ru4s-d12 idec, relay, 4pdt, 240vac, 30vdc, 6a; contact configuration:4pdt; coil voltage:12vdc; contact current:6a; product range:ru series; relay mounting:socket; coil type:non latching; contact voltage vac:240vac;  
ru4s-d24 idec, relay, 4pdt, 240vac, 30vdc, 6a; contact configuration:4pdt; coil voltage:24vdc; contact current:6a; product range:ru series; relay mounting:socket; coil type:non latching; contact voltage vac:240vac;  
ru4s-m etc2 [list of unclassified manufacturers], series general purpose relay  
ru4s-m-a110 idec  
ru4s-m-a220 glenair  
ru4s-m-a24 glenair  
ru4s-m-d110 idec  
ru4s-m-d12 glenair  
ru4s-m-d24 glenair  
ru4sa110 idec  
ru4sa220 idec  
ru4sa24 idec  
ru4sca110 idec  
ru4sca220 idec  
ru4sca24 idec  
ru4scd110 idec  
ru4scd12 idec  
ru4scd24 idec  
ru4scdd12 idec  
ru4scdd24 idec  
ru4sd110 idec

ru4sd12 idec  
ru4sd24 idec  
ru4sdd12 idec  
ru4sdd24 idec  
ru4sma110 idec  
ru4sma24 idec  
ru4smd110 idec  
ru4smd12 idec  
ru4smd24 idec  
ru4s-a110 idec, power relay, 4pdt, 110vac, 6a, plug in; product range:idec — ru series; coil voltage:110vac; contact current:6a; contact voltage vac:240v;  
contact voltage vdc:30v; contact configuration:4pdt; coil res  
ru4s-a110-120 idec  
ru4s-a220 idec, power relay, 4pdt, 220vac, 6a, plug in; product range:idec — ru series; coil voltage:220vac; contact current:6a; contact voltage vac:240v;  
contact voltage vdc:30v; contact configuration:4pdt; coil res  
ru4s-a220-240 glenair  
ru4s-a24 glenair  
ru4s-c-a110 glenair  
ru4s-c-a220 glenair  
ru4s-c-a24 glenair  
ru4s-c-d110 glenair  
ru4s-c-d12 glenair  
ru4s-c-d24 glenair  
ru4s-d-d24 glenair  
ru4s-d110 glenair  
ru4s-d12 glenair  
ru4s-d24 idec  
ru4s-m-a110 idec  
ru4s-m-a220 glenair  
ru4s-m-a24 glenair  
ru4s-m-d110 idec  
ru4s-m-d12 glenair  
ru4s-m-d24 glenair  
ru4s-c-d12 idec corporation  
ru4s-cd-d12 idec corporation  
ru4s-d12 idec corporation  
ru4s-d24 idec, relay, 4pdt, 24vdc, 6a, socket  
ru4s-md-d110 idec corporation  
ru4s-a110 idec, power relay, 4pdt, 110vac, 6a, plug in; product range:idec — ru series; coil voltage:110vac; contact current:6a; contact voltage vac:240v;  
contact voltage vdc:30v; contact configuration:4pdt; coil res  
ru4s-a110-120 idec  
ru4s-a220 idec, power relay, 4pdt, 220vac, 6a, plug in; product range:idec — ru series; coil voltage:220vac; contact current:6a; contact voltage vac:240v;  
contact voltage vdc:30v; contact configuration:4pdt; coil res  
ru4s-a220-240 glenair  
ru4s-a24 idec, power relay, 4pdt, 24vac, 6a, plug in; product range:idec — ru series; coil voltage:24vac; contact current:6a; contact voltage vac:240v;  
contact voltage vdc:30v; contact configuration:4pdt; coil res  
ru4s-c-a110 idec, power relay, 4pdt, 110vac, 6a, plug in; product range:idec — ru series; coil voltage:110vac; contact current:6a; contact voltage vac:240v;  
contact voltage vdc:30v; contact configuration:4pdt; coil res  
ru4s-c-a220 idec, power relay, 4pdt, 220vac, 6a, plug in; product range:idec — ru series; coil voltage:220vac; contact current:6a; contact voltage vac:240v;  
contact voltage vdc:30v; contact configuration:4pdt; coil res  
ru4s-c-a24 idec, power relay, 4pdt, 24vac, 6a, plug in; product range:idec — ru series; coil voltage:24vac; contact current:6a; contact voltage vac:240v;  
contact voltage vdc:30v; contact configuration:4pdt; coil res  
ru4s-c-d110 idec, power relay, 4pdt, 110vdc, 6a, plug in; product range:idec — ru series; coil voltage:110vdc; contact current:6a; contact voltage vac:240v;  
contact voltage vdc:30v; contact configuration:4pdt; coil res  
ru4s-c-d12 idec, power relay, 4pdt, 12vdc, 6a, plug in; product range:idec — ru series; coil voltage:12vdc; contact current:6a; contact voltage vac:240v;  
contact voltage vdc:30v; contact configuration:4pdt; coil res  
ru4s-c-d24 idec, power relay, 4pdt, 24vdc, 6a, plug in; product range:idec — ru series; coil voltage:24vdc; contact current:6a; contact voltage vac:240v;  
contact voltage vdc:30v; contact configuration:4pdt; coil res  
ru4s-d-d24 glenair  
ru4s-d110 glenair  
ru4s-d12 idec, power relay, 4pdt, 12vdc, 6a, plug in; product range:idec — ru series; coil voltage:12vdc; contact current:6a; contact voltage vac:240v;  
contact voltage vdc:30v; contact configuration:4pdt; coil res  
ru4s-d24 idec, power relay, 4pdt, 24vdc, 6a, plug in; product range:idec — ru series; coil voltage:24vdc; contact current:6a; contact voltage vac:240v;  
contact voltage vdc:30v; contact configuration:4pdt; coil res  
ru4s-m-a110 idec  
ru4s-m-a220 glenair  
ru4s-m-a24 glenair  
ru4s-m-d110 idec  
ru4s-m-d12 glenair  
ru4s-m-d24 glenair

**каталог, описание, технические, характеристики, datasheet, параметры, маркировка, габариты, фото, 230, 220, 250, VAC , IDEC, реле**

**Минск +375447584780 Viber email [minsk17@tut.by](mailto:minsk17@tut.by)  
[www.fotorele.net](http://www.fotorele.net) [www.tiristor.by](http://www.tiristor.by) tel.+375 29 758 47 80 МТС**

---

**Минск +375447584780 Viber email [minsk17@tut.by](mailto:minsk17@tut.by)**



## Электронные компоненты, радиодетали

[где и как купить в Минске?](#)

Категория: **IDEC, РЕЛЕ**

Заказ г.Минск viber и тел. +375447584780 email: [minsk17@tut.by](mailto:minsk17@tut.by)

**RU Series — General Purpose Relays**

**Key features of the RU series include:**

- Non-polarized LED indicator standard
- Solder-free construction (spot welded, no solder points, lead-free)
- No internal wires
- Mechanical flag indicator standard
- Manual latching lever with color coding for AC or DC coil
- Available without latching lever (or with momentary check button)
- Snap-on marking plate standard
- Cadmium-free contacts - RoHS compliant
- Color coded coils for visual distinction
- Contact rating 6A: 4PDT  
10A: DPDT



**Relays**

	RU2	RU4
<b>Contact Material</b>	AgSnOIn (silver tin oxide indium)	AuAg/Ag (gold-silver alloy on silver)
<b>Contact Resistance</b>	50 mΩ maximum	
<b>Minimum Applicable Load</b>	24VDC, 5mA (reference value)	1V DC, 1mA (standard) 1V DC, 0.1mA (bifurcated)
<b>Operating Time</b>	20 msec maximum	
<b>Release Time</b>	20 msec maximum	
<b>Maximum Continuous Applied Voltage (AC/DC) at 20°C</b>	110%	
<b>Minimum Operating Voltage (AC/DC) at 20°C</b>	80%	
<b>Drop-Out Voltage (AC) at 20°C</b>	30%	
<b>Drop-Out Voltage (DC) at 20°C</b>	10%	
<b>Power Consumption</b>	1.1-1.4VA (AC); 0.9-1.0W (DC)	
<b>Dielectric Strength</b>	Between contact and coil: 2,500VAC, 1 minute Between poles: 2,500VAC, 1 minute Between contacts of the same pole: 1,000VAC, 1 minute	Between contact and coil: 2,500VAC, 1 minute Between poles: 2,000VAC, 1 minute Between contacts of the same pole: 1,000VAC, 1 minute
<b>Frequency Response</b>	1,800 operations/hr	
<b>Vibration Resistance</b>	Operating extremes: 10 to 55Hz, Amplitude 1.0 mm p-p Damage limits: 10 to 55Hz, Amplitude 1.0 mm p-p	
<b>Shock Resistance</b>	Operating extremes: 150 m/s <sup>2</sup> (15G) Damage limits: 1,000 m/s <sup>2</sup> (100G)	
<b>Life Expectancy</b>	Mechanical: AC: 20,000,000 operations minimum DC: 30,000,000 operations minimum Electrical: see electrical life curve	
<b>Degree of Protection</b>	IP40	
<b>Operating Temperature</b>	-55 to +70°C (no freezing)	
<b>Weight</b>	35g	

**Specifications**



UL Recognized  
File No. E66043, Vol 8, sec. 1  
Vol 8, sec. 2



B020813332451



CSA Certified  
File No. LR35144-135844



**Ordering Information**

Consult factory for other voltages.

**Basic Part No.**      **Coil Voltage:**

**RU 4 S - ( ) - D12**

**# of Contacts**      **Coil Voltage Code\*\***

2 = DPDT  
4 = 4PDT  
42 = 4PDT bifurcated contacts

**Option\***

(Blank) = with latching check button  
C = without check button  
M = momentary check button  
D = surge suppression diode (DC coils only)

D12 = 12V DC  
D24 = 24V DC  
D110 = 110V DC  
A24 = 24V AC  
A110 = 110-120V AC  
A220 = 220-240V AC



- \*All come with bi-polar LED, mechanical flag indicator, marking plate.
- \*\*Contact IDEC for other voltages.

## Part Numbers

### Part Numbers: RU Series with Options

Termination		Contact Configuration	Standard	Without Latching Lever	With Momentary Check Button	With Diode*
S: Solder/plugin	Standard	DPDT	RU2S	RU2S-C	RU2S-M	RU2S-D
		4PDT	RU4S	RU4S-C	RU4S-M	RU4S-D
	Bifurcated	4PDT	RU42S	RU42S-C	RU42S-M	RU42S-D



\*DC coils only.

### Part Numbers: Sockets

Relays	Spring Clamp DIN Rail Mount	Standard DIN Rail Mount	Finger-Safe DIN Rail Mount	Panel Mount	PC Mount	Springs & Clips (optional)	
						Part Number	Use With
RU2S	SU2S-11L	SM2S-05	SM2S-05C	SY4S-51	SY4S-61 SY4S-62	SFA-101① SFA-202② SY4S-02F1③	use with SY4S-05, -05C SM2S-05, -05C SU4S-11L, SU2S-11L
RU4S	SU4S-11L	SY4S-05	SY4S-05C			SFA-301① SFA-302② SY4S-51F1③	use with SY4S-51, -61



See Section F for details on sockets. All DIN rail mount sockets shown above can be mounted using DIN rail BNDN1000.



- ① Top latch
- ② Side latch
- ③ Pullover spring

### Part Numbers: Marking Strip

Item	Part Number	Quantity
RU Marking Strip	RU9Z-P①PN10,	10 pieces per package



In place of ①, insert color code from chart at right.

### Marking Strip Color Code

Color	Code	Color	Code
Yellow*	Y	Blue	S
Green	G	White	W
Amber	A		



\*yellow marking strip standard on all RU relays.

## Ratings

### Coil Ratings

Rated Voltage	Voltage Code	Coil Tape Colors	Rated Current ±15% at 20°C	Coil Resistance ±10% at 20°C	Inrush Current	Inductance	
						Energizing	De-Energizing
AC	24V	A24	white	37.5mA	164 Ω	60mA	1.8H / 0.96H
	110-120V	A110	dark blue	8.4mA	4,550 Ω	14mA	36H / 22H
	220-240V	A220	red	4.2mA	18,230Ω	7mA	144H / 87H
DC	12V	D12	yellow*	83.3mA	160 Ω	N/A	
	24V	D24	green	41.7mA	605 Ω		
	110V	D110	yellow*	9.1mA	12, 100 Ω		



\*Voltage printed in black.

### Contact Ratings (Standard)

Voltage		Resistive	Inductive
30V DC	DPDT	10A	5A
	4PDT	6A	3A
110V DC	DPDT	0.6A	0.3A
	4PDT	0.4A	0.2A
120V AC	DPDT	10A	5A
	4PDT	6A	3A
240V AC	DPDT	10A	5A
	4PDT	6A	3A

### Contact Ratings (Bifurcated)

Voltage		Resistive	Inductive
30V DC	4PDT	3A	1.5A
110V DC	4PDT	—	—
120V DC	4PDT	3A	0.8A
250V DC	4PDT	3A	0.8A

Internal Circuit\*

**RU2S Standard**

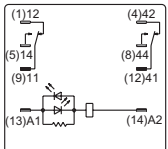

Over 24V AC/DC

**RU2S-D with Diode**

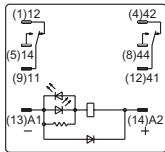

Over 24V DC

**RU4S/RU42S Standard**

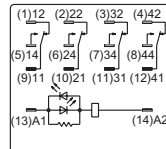

Over 24V AC/DC

**RU4S-D/RU42S-D with Diode**

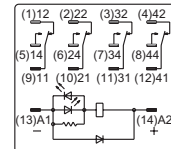

Over 24V DC

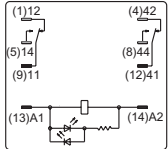

24V AC/DC or less

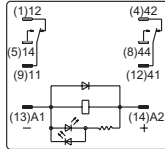

24V DC or less

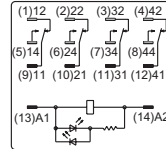

24V AC/DC or less

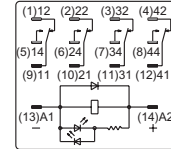

24V DC or less



Image as viewed from bottom of relay. Refer to socket for exact wiring layout (Section F).



Numbers not in parenthesis follow international system of labeling terminals.

Electrical Life Curves

RU2 (Resistive Load)

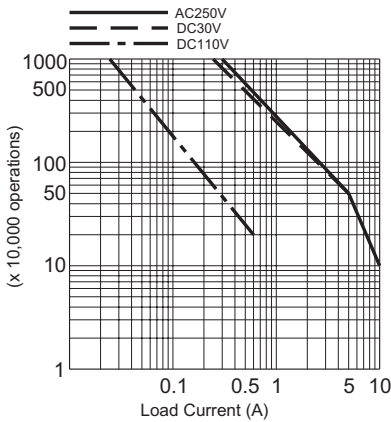

RU4 (Resistive Load)

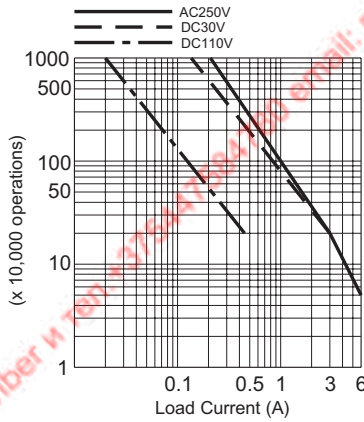

RU42 (Resistive Load)

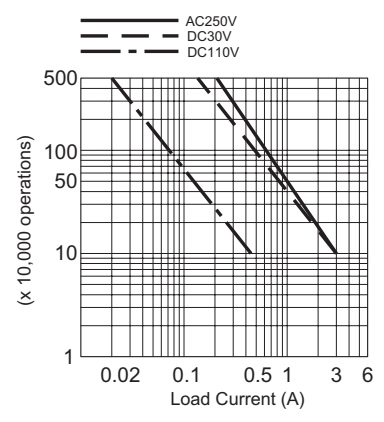

RU2 (Inductive Load)

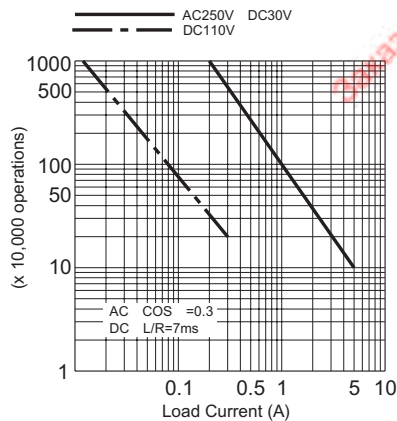

RU4 (Inductive Load)

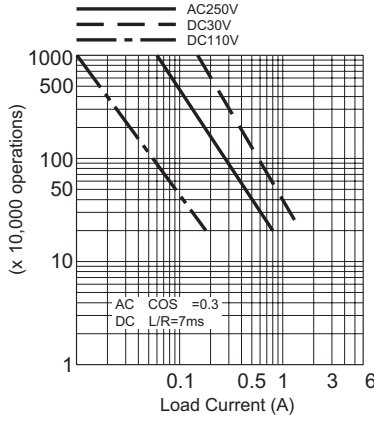

RU42 (Inductive Load)

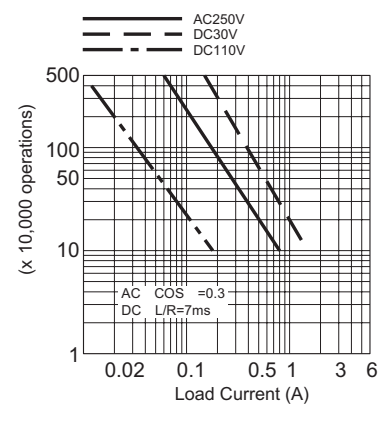

## Maximum Switching Capacity

RU2 (Maximum Load)

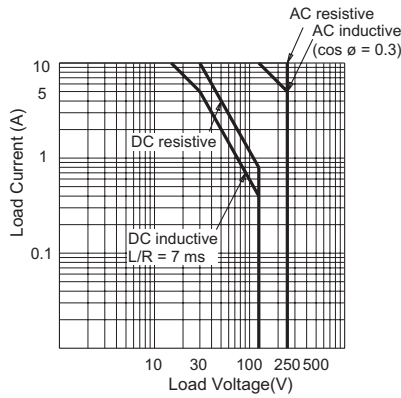

RU4 (Maximum Load)

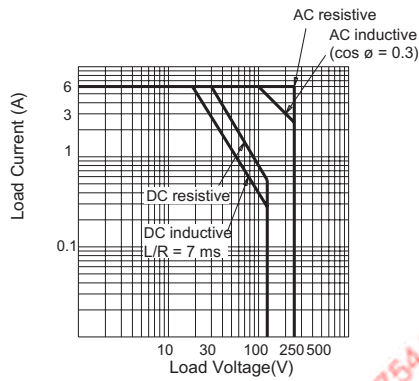

RU42 (Maximum Load)

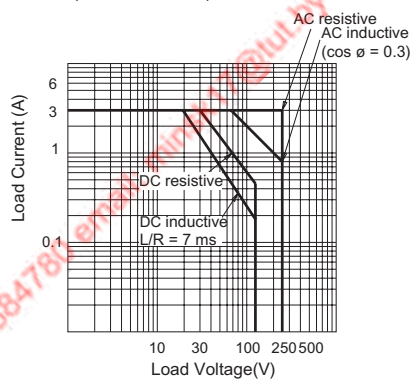

## Dimensions & Mounting Hole Layouts

RU2  
Dimensions

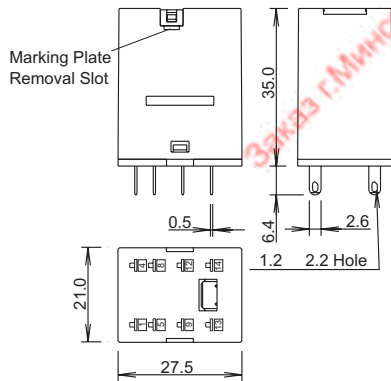

Marking plate removal slot is provided only on one side.  
Insert a flat screwdriver into the slot to remove the marking plate.

RU4/RU42  
Dimensions

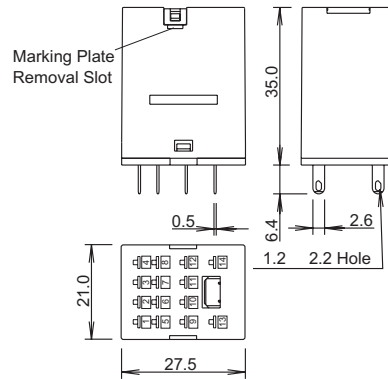

Marking plate removal slot is provided only on one side.  
Insert a flat screwdriver into the slot to remove the marking plate.

Dimensions are in mm.



**Hold-Down Springs and Clips Selection Guide**

**DIN Rail Snap/Surface-Mount Sockets**

Socket Part No.	Applicable Relays, Timer	Hold-Down Pullover Spring	Hold-Down Clip (side latch)	Hold-Down Clip (top latch)
SU2S-11L SU4S-11L	RM2S, RU2, GT5Y-2	SY4S-51F1	SFA-202	SFA-101
	RY4S, RY42S, RU4, RU42, GT5Y, RY2KS, RM2S	SY4S-51F1	SFA-202	SFA-101
SR2P-05 SR2P-05C	RR2P	SR2B-02F1	SFA-203	—
	RTE-P1, GT3, GT5P	—	SFA-203	—
SR2P-06	RR2P	SR2B-02F1	SFA-202	—
	GT3 (8-pin), RTE-P1, GT5P	—	SFA-202	—
SR3P-05 SR3P-05C	RR3PA	SR3B-02F1	SFA-203	—
	RR2KP	SR3P-06F3	SFA-203	—
	RTE-P2, GT3 (11-pin)	—	SFA-203	—
SR3P-06	RR3PA	SR3B-02F1	SFA-202	—
	RR2KP	SR3P-06F3	SFA-202	—
	RTE-P2, GT3 (11-pin)	—	SFA-202	—
SR3B-05	RR1BA, RR2BA, RR3B, RTE-B	SR3B-02F1	SFA-202	—
SH1B-05 SH1B-05C	RH1B	SY2S-02F1	SFA-202	SFA-101
SH2B-05 SH2B-05C	RH2B	SY4S-02F1	SFA-202	SFA-101
SH3B-05 SH3B-05C	RH3B, RH2LB	SH3B-05F1	SFA-202	SFA-101
SH4B-05 SH4B-05C	RH4B	SH4B-02F1	SFA-202	SFA-101
SY2S-05 SY2S-05C	RY2S, RY22S	SY2S-02F1	SFA-202	SFA-101
SY4S-05 SY4S-05C	RY4S, RY42S, RU4, RU42, RM2S	SY4S-51F1	SFA-202	SFA-101
	RY2KS, GT5Y	(SY4S-51F3)	SFA-202	
SM2S	RM2S, RU2	SY4S-51F1	SFA-202	SFA-101
SJ1S SJ2S	RQ1S RJ2S	SJ9Z-C		
SQ1S SQ2S	RQ1V RQ2V	SQ9Z-C		

1. Hold-down springs work in conjunction with hold-down spring anchors included with DIN rail sockets.
2. When mounting relays with a check button onto panel mount or PC board mount sockets, use the hold-down spring shown in parenthesis. Hold-down springs for relays with check buttons are not available for SR2P-51.
3. For close mounting of panel mount or PC mount sockets, use hold-down clips rather than hold-down springs.
4. SFA-101, SFA-202 and SFA-302 come in pairs.

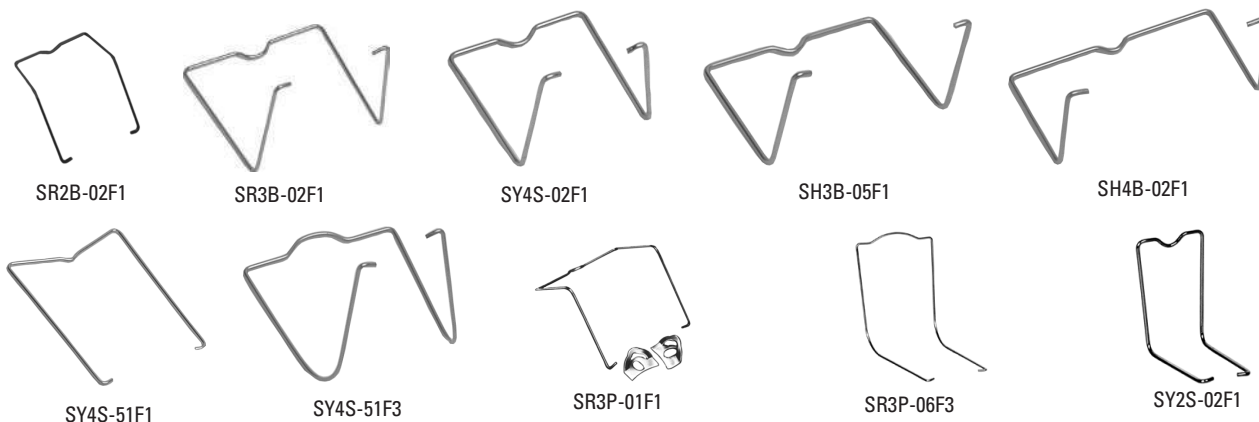

Sockets

www.idec.com | Минск | Email: minsk17@idc.by | Тел: +375447584780

## Panel and PC Board Mount Sockets

Socket Part No.	Applicable Relays, Timer	Hold-Down Pullover Spring	Hold-Down Clip (side latch)	Hold-Down Clip (top latch)
SR2P-51	RR2P	SR3P-01F1	—	—
	GT3 (8-pin), RTE-P1	—	SFA-402	—
SR3P-51	RR3PA	SR3P-01F1	—	—
	RR2KP	SR3P-51F3	—	—
	GT3 (11-pin), RTE-P2	—	SFA-402	—
SR3B-51	RR1BA, RR2BA, RR3B, RTE-B	SR3B-02F1	—	—
SH1B-51 SH1B-62	RH1B	SY4S-51F1	—	SFA-301 SFA-302
SH2B-51	RH2B	SY4S-51F1 (SY4S-02F1)	—	SFA-301 SFA-302
SH2B-62	RH2B	SY4S-51F1 (SY4S-02F1)	—	—
SH3B-51 SH3B-62	RH3B, RH2LB	SY4S-51F1 (SY4S-02F1)	—	SFA-301 SFA-302
SH4B-51 SH4B-62	RH4B	SY4S-51F1 (SH4B-02F1)	—	SFA-301 SFA-302
SY2S-51 SY2S-61	RY2S, RY22S	SY4S-51F1	—	SFA-301 SFA-302
SY4S-51 SY4S-61	RY4S, RY42S	SY4S-51F1 (SY4S-02F1)	—	SFA-301 SFA-302
	RY2KS	SY4S-51F1 (SY4S-02F3)	SFA-302	—
	GT5Y	—	SFA-302	—
SY4S-62 *	RY4S, RY42S, RM2S	SY4S-51F1 (SY4S-02F1)	—	—
	RY2KS	SY4S-51F1 (SY4S-02F3)	—	—

\* Does not accept hold down clips



SFA-101



SFA-202

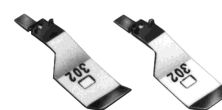

SFA-302



SFA-301



SFA-203



SFA-402

**SU Series: DIN Rail Snap-Mount Sockets**



**SU2S-11L**

<b>Style</b>	8-blade DIN-mount/surface mount
<b>Terminal</b>	Spring clamp terminals
<b>Wire Size</b>	24-16 AWG
<b>Electrical Rating</b>	10A
<b>Compatible Relay</b>	RU2, RM2
<b>Compatible Timer</b>	GT5Y-2
<b>Hold-Down Clip</b>	SFA-101 (top latch), SFA-202 (side latch)

**SU4S-11L**

<b>Style</b>	14-blade DIN-mount/surface mount
<b>Terminal</b>	Spring clamp terminals
<b>Wire Size</b>	24-16 AWG
<b>Electrical Rating</b>	6A (using RU4), 10A (using RU2)
<b>Compatible Relay</b>	RY4S, RY42S, RU4, RU42S, RY2KS, RM2S
<b>Compatible Timer</b>	GT5Y
<b>Hold-Down Clip</b>	SFA-101 (top latch), SFA-202 (side latch)

Sockets



1. On the SU2S, wires or ferrules cannot be connected to terminals 2, 3, 6, 7, 10 or 11 because neither springs nor conductive brackets are installed in these terminals.
2. For socket mounting accessories, see page F-29.

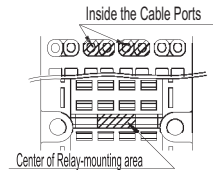

**Terminal Arrangement (top view)**

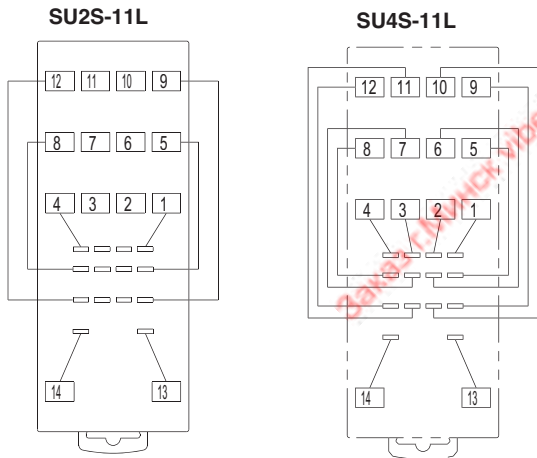

**Dimensions**

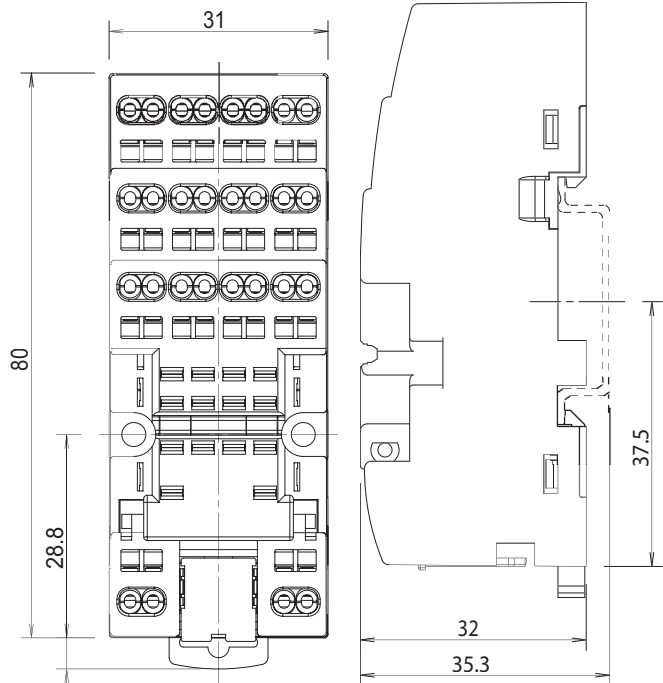

**Parts**

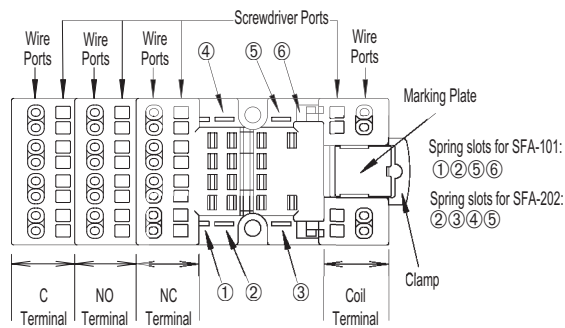

**Panel Cutout for Surface Mounting**

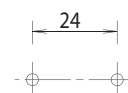

All dimensions are in mm.

## SY4S Sockets

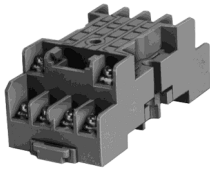

### SY4S-05

<b>Style</b>	14-blade, snap-mount/surface mount
<b>Terminal/Torque</b>	M3 screw with captive wire clamp (5.5 - 9 in • lbs)
<b>Wire Size</b>	Maximum up to 2-#14AWG
<b>Electrical Rating</b>	300V, 7A
<b>Compatible Relay</b>	RY4S, RY42S, RU4S, RU42S, RM2S, *RY2KS, (*latching relay)
<b>Compatible Timer</b>	GT5Y
<b>Hold-Down Spring</b>	SY4S-51F1 for all relays; SY4S-51F3 for RY2KS only
<b>Hold-Down Clip</b>	SFA-101 (top notch), SFA-202 (side notch) for all relays and timers

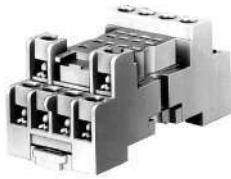
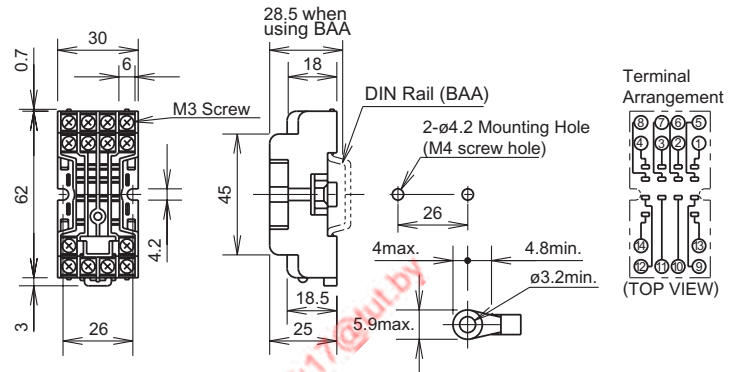

### SY4S-05C Fingersafe

<b>Style</b>	14-blade, snap-mount/surface mount
<b>Terminal/Torque</b>	M3 screw with captive wire clamp, fingersafe (5.5 - 9 in • lbs)
<b>Wire Size</b>	Maximum up to 2-#14AWG
<b>Electrical Rating</b>	300V, 7A
<b>Compatible Relay</b>	RY4S, RY42S, RM2S, RU4S, RU42S, *RY2KS, (*latching relay)
<b>Compatible Timer</b>	GT5Y
<b>Hold-Down Spring</b>	SY4S-51F1 for all relays; SY4S-51F3 for RY2KS only
<b>Hold-Down Clip</b>	SFA-101 (top notch), SFA-202 (side notch) for GT5Y timer and relays

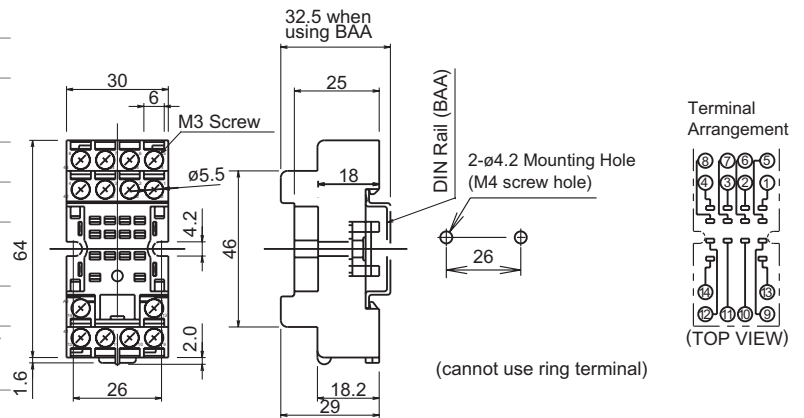

All dimensions are in mm.



1. For socket mounting accessories, see page F-29.
2. For hold-down clip/spring selections, see page F-4.

SM2S Sockets

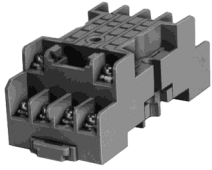

SM2S-05

<b>Style</b>	8-blade, snap-mount/surface mount
<b>Terminal/Torque</b>	M3 screw with captive wire clamp (5.5 - 9 in •lbs)
<b>Wire Size</b>	Maximum up to 2-#14AWG
<b>Electrical Rating</b>	300V, 10A
<b>Compatible Relay</b>	RU2S, RM2S
<b>Compatible Timer</b>	—
<b>Hold-Down Spring</b>	SY4S-51F1
<b>Hold-Down Clip</b>	SFA-101 (top notch), SFA-202 (side notch)

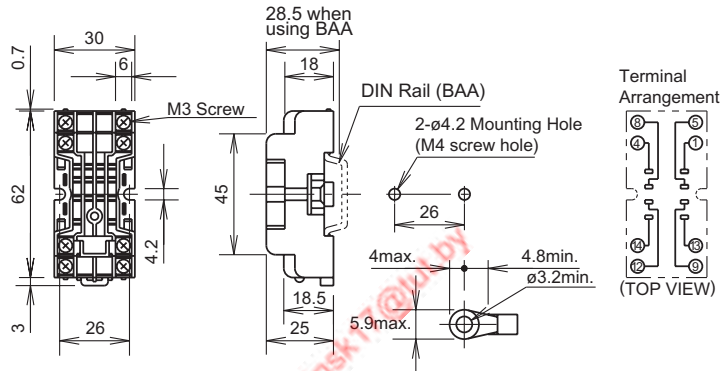

F

Sockets



SM2S-05C Fingersafe

<b>Style</b>	8-blade, snap-mount/surface mount
<b>Terminal/Torque</b>	M3 screw with captive wire clamp, fingersafe (5.5 - 9 in •lbs)
<b>Wire Size</b>	Maximum up to 2-#14AWG
<b>Electrical Rating</b>	300V, 10A
<b>Compatible Relay</b>	RU2S, RM2S
<b>Compatible Timer</b>	—
<b>Hold-Down Spring</b>	SY4S-51F1
<b>Hold-Down Clip</b>	SFA-101 (top notch), SFA-202 (side notch)

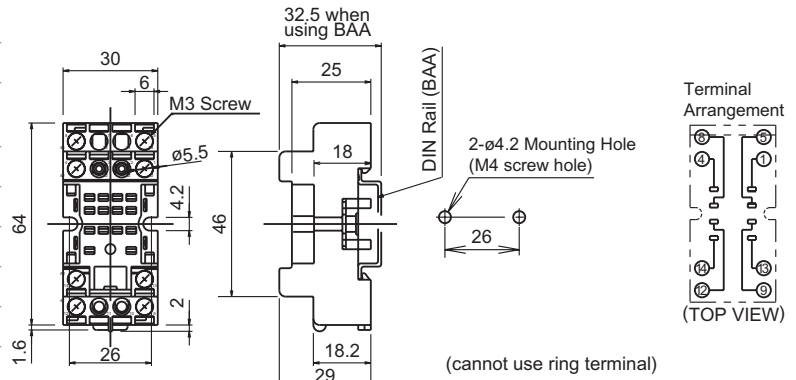

All dimensions are in mm.



1. For socket mounting accessories, see page F-29.
2. For hold-down clip/spring selections, see page F-4.

**SY Series: Panel Mount Sockets**

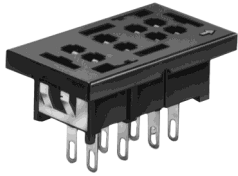

**SY2S-51**

<b>Style</b>	8-blade, panel mount
<b>Terminal</b>	Solder
<b>Electrical Rating</b>	300V, 7A
<b>Compatible Relay</b>	RY2S, RY22S
<b>Hold-Down Spring</b>	SY4S-51F1
<b>Hold-Down Clip</b>	SFA-301 (top notch), SFA-302 (side notch)

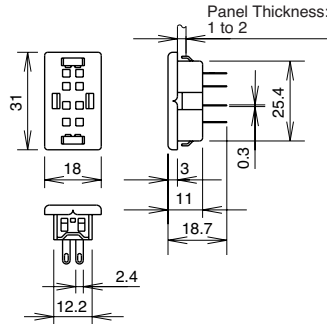

**Terminal Arrangement**

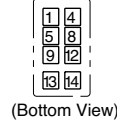

(Bottom View)

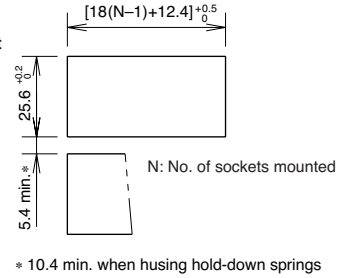

**F**

**Sockets**

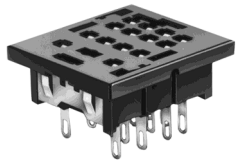

**SY4S-51**

<b>Style</b>	14-blade, panel mount
<b>Terminal</b>	Solder
<b>Electrical Rating</b>	300V, 7A
<b>Compatible Relay</b>	RY4S, RY42S, RM2S, RY2KS, RU4S, RU2S, RU42S
<b>Compatible Timer</b>	GT5Y
<b>Hold-Down Spring</b>	SY4S-51F1 for all relays except; SY4S-02F3 for RY2KS relay
<b>Hold-Down Clip</b>	SFA-301 (top notch), SFA-302 (side notch)

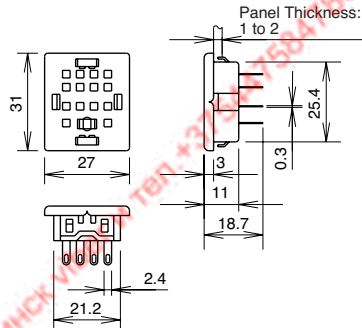

**Terminal Arrangement**

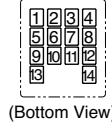

(Bottom View)

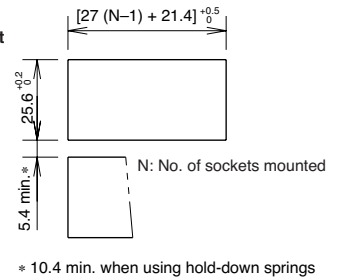

All dimensions are in mm.



1. For socket mounting accessories, see page F-29.
2. For hold-down clip/spring selections, see page F-4.

## SY Series: PC Mount Sockets, continued



**SY4S-61**

<b>Style</b>	14-blade
<b>Terminal</b>	Solder/PCB mount
<b>Electrical Rating</b>	300V, 7A
<b>Compatible Relay</b>	RY4S, RY42S, RM2S, *RY2KS, RU4S, RU42S, RU2S (*latching relay)
<b>Compatible Timer</b>	GT5Y
<b>Hold-Down Spring</b>	SY4S-51F1, SY4S-02F1
<b>Hold-Down Clip</b>	SFA-301 (top notch; except GT5Y and RY2KS) SFA-302 (side notch for all)

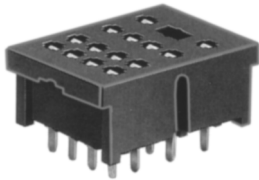
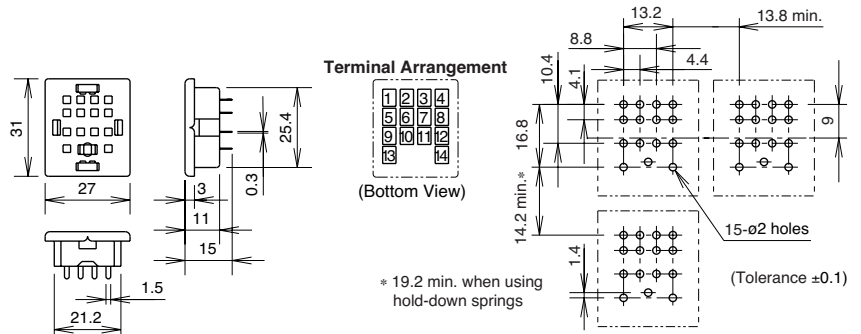

**SY4S-62**

<b>Style</b>	14-blade
<b>Terminal</b>	Solder/PCB mount
<b>Electrical Rating</b>	250V, 7A
<b>Compatible Relay</b>	RY4S, RY42S, RU4S, RU42S, *RY2KS (*latching relay)
<b>Compatible Timer</b>	GT5Y
<b>Hold-Down Spring</b>	SY4S-51F1, SY4S-51F3, SY4S-51F4, *SY4S-02F1, *SY4S-02F3 (*when mounting a relay with check button)

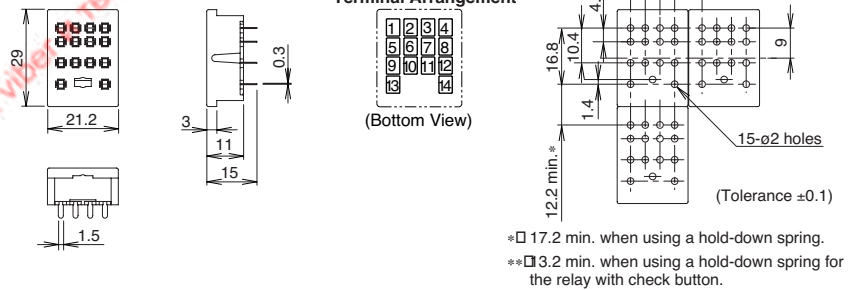

All dimensions are in mm.



1. For socket mounting accessories, see page F-29.
2. For hold-down clip/spring selections, see page F-4.

## Accessories

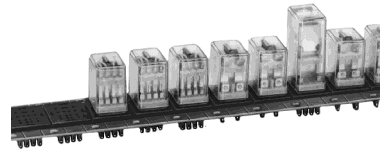
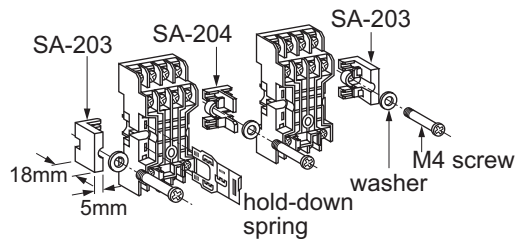

Description	Appearance	Use with	Part No.	Remarks
<b>Aluminum DIN Rail</b> (1 meter length)		All DIN rail sockets	BNDN1000	IDEC offers a low-profile DIN rail (BNDN1000). The BNDN1000 is designed to accommodate snap-mount sockets. Made of durable extruded aluminum, the BNDN-1000 measures 0.413 in height and 1.37 (35mm) in width (DIN standard). Standard length is 39" (1,000mm).
<b>DIN Rail End Stop</b>		DIN rail	BNL5	9.1 mm wide.
<b>Surface Mount End Connector</b>		SY2S, SY4S, SR3B, SH1B, SH2B, SH3B, SH4B	SA-203	For use on ends of socket groupings when surface mounting.
			SA-204	For use between adjoining sockets when surface mounting.
<b>Surface Mount Connector</b>		SY2S, SY4S, SR3B, SH1B, SH2B, SH3B, SH4B	SA-405	For use between adjoining sockets when surface mounting.
<b>DIN Rail Spacer</b>		All DIN rail sockets	SA-406	
<b>Steel Mounting Plates</b> (for panel mount sockets)		SY4S-51, SH2B-51	SA-402	11.42" length with 10 holes.
			SA-403	23.33" length with 21 holes.
<b>Relay Holders</b>		RH2B, RM2S, RY4S, RY42S, RU4S, RU42S	RH-01	For diagram, see next page.
		RY2S, RH1B	RH-03	
<b>Replacement Hold-Down Spring Anchor</b>		Horseshoe clip for all DIN rail sockets except SR*P-05(C)	Y778-011	For use with hold-down springs (bale wire types) or DIN rail mount sockets. 2 pieces included with each socket.
<b>Hold-Down Spring for SR*P-05(C)</b>		Chair clip for SR*P-05(C)	Y703-102	For SR2P-05, SR2P-05C, SR3P-05, SR3P-05C

F

Sockets