

The following page(s) are extracted from multi-page Kuhnke product catalogues or CDRoms and any page number shown is relevant to the original document. The PDF sheets here may have been combined to provide technical information about the specific product(s) you have selected.

Hard copy product catalogues, and CDRoms have been published describing Kuhnke Pneumatics, Solenoids, Relays and Electronics; some divided into different books. A list of current publications is available on this web site or from our sales offices. Some may be available for download, but as substantially larger files.

## Contact Details

Kuhnke sales and service in the UK

H. Kuhnke Ltd  
Unit 6 Focus 303  
Focus Way, Walworth Business Park  
Andover  
Hampshire  
SP10 5NY  
United Kingdom

Tel: +44 (0)1264 364194  
Fax: +44 (0)1264 365991  
Email: [sales@kuhnke.co.uk](mailto:sales@kuhnke.co.uk)

### Important Note

The information shown in these documents is for guidance only. No liability is accepted for any errors or omissions. The designer or user is solely responsible for the safe and proper application of the parts, assemblies or equipment described.

## General Purpose Relays Modular Relay Group

email: [minsk17@tut.by](mailto:minsk17@tut.by) тел. +375 44 758 4780

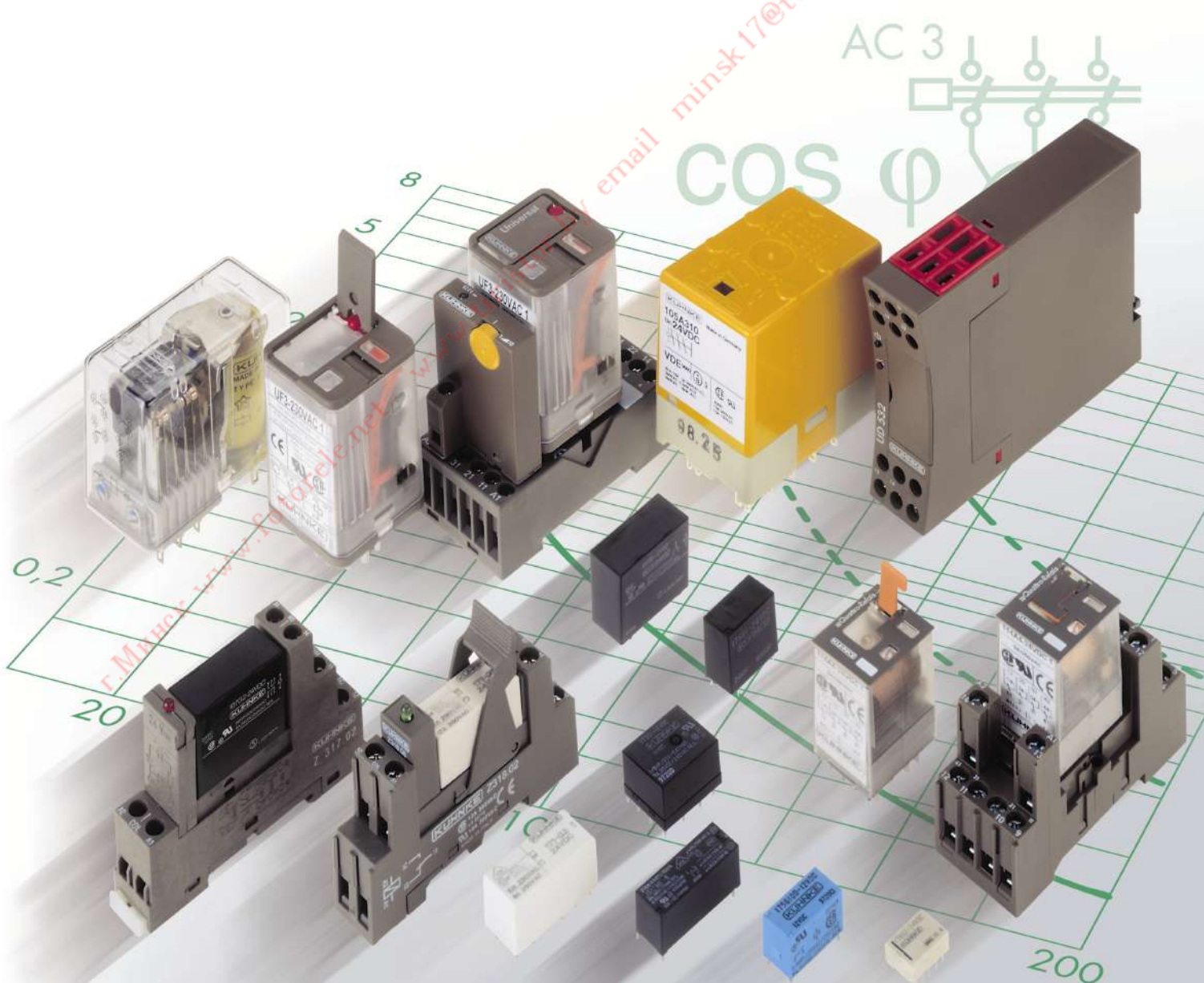

# Quic-Pics Catalog

## General Purpose Relays Modular Relay Group

Contents:

	Quic Pics Page	Technical Data Page
Octal Socket Relays, Standard Types, 10 Ampere Max.	1	23
Octal Socket Relays, Low Power Level Switching	1	23
Square Base Blade Relays, Standard Types, 10 Ampere Max.	3	23
Square Base Blade Relays, Low Power Level Switching	3	23
Ice Cube Relays, 10 Ampere Max.	5	25
Ice Cube Relays, 5 Ampere Max.	7	27
PCB Interface Relays, 5, 10, 16 Ampere Max.	9	29
Power PCB Interface Relays, 10, 12, 16 Ampere Max.	11	31
Accessories, Relay Sockets	13	—
Accessories, Timing Module	19	—
Accessories, LED's, Surge Suppressors	21	—
General Information, Relays	33	—

In motion ...

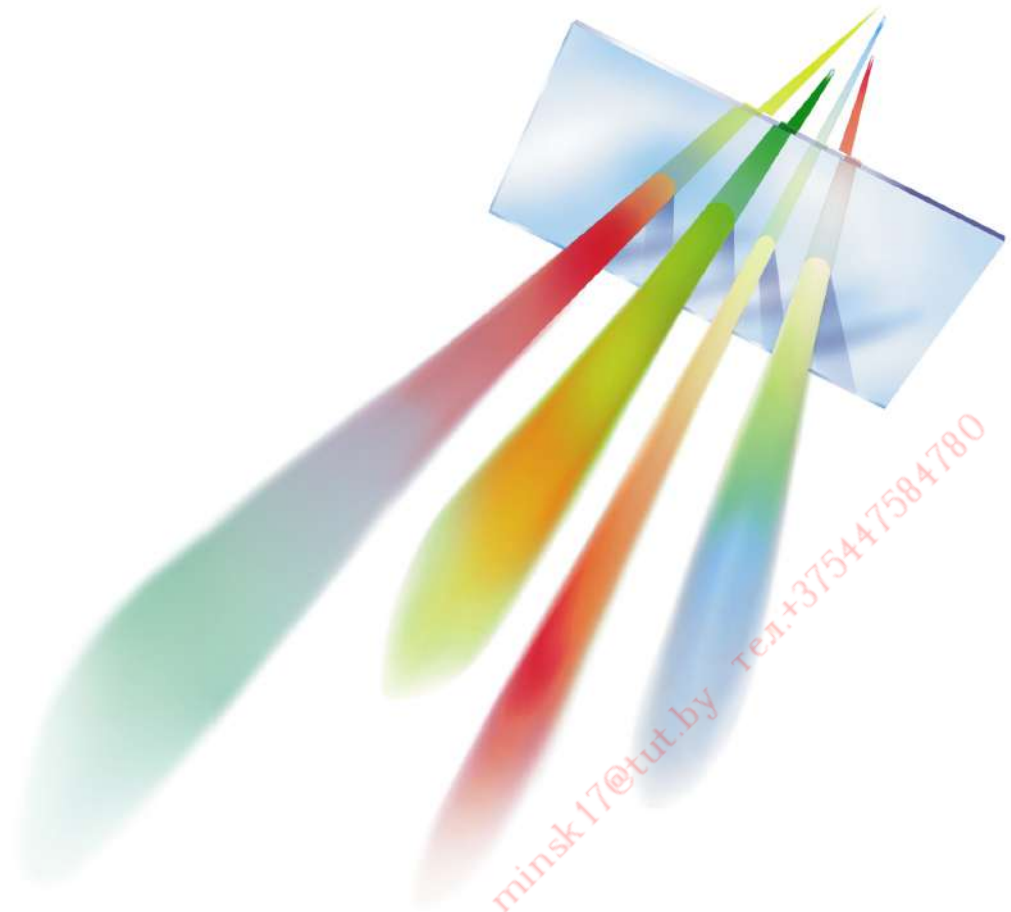

This catalog reflects only a small part of the worldwide activities of Kuhnke with its components divisions:

- Relays,
- Electronics,
- Pneumatics,
- Solenoids.

Kuhnke's products are designed for simple cost-effective use in all fields of automation. Our innovative approach can help to solve more complex problems either as single products or with systems combining our four technologies.

From the start, Kuhnke has been a pioneer in the continued process of miniaturization in automation technology. Today's examples are small solenoid actuators for door locks, intelligent item micropneumatics, fast bus-interfacing microcontrollers and modules, and the Universal concept that is the basis of all Kuhnke relays.

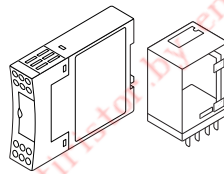

Relays

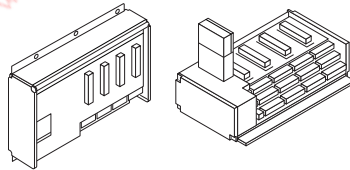

Electronic Systems

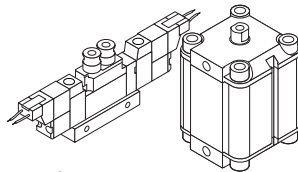

Pneumatics

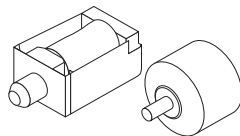

Solenoids

And Kuhnke will develop customer-specific variations of all these products to suit particular applications. To Kuhnke, specials are standard.

Kuhnke is an ISO 9001 registered company reflecting the highest quality standards for all operating divisions, products and services.

Ask Kuhnke for more information about these catalog items, or to find out how our four technologies may be combined into the latest innovative system solution for you.

**KUHNKE ...  
IMPULSES FOR  
AUTOMATION.**

www.kuhnke.com  
minsk17@tut.by тел.+375447584780

## Corporate Headquarters

Kuhnke GmbH  
Lütjenburger Straße 101  
D-23714 Malente  
Germany  
Phone (cc 49) 4523 402 - 0  
Fax (cc 49) 4523 402 247  
E-Mail sales@kuhnke.de  
Internet www.kuhnke.de



## Worldwide Relay Contacts:

### Australia

G.Z. Pneumatic Pty. Ltd.  
46 Lillimur Avenue  
Heidelberg West, Vic.3081  
Phone (cc 61) 3 9459 33 41  
Fax (cc 61) 3 9458 34 67

### Austria

Kuhnke Automation GmbH  
Schumanngasse 38a  
2380 Perchtoldsdorf  
Phone (cc 43) 1 869 62 00 0  
Fax (cc 43) 1 869 62 00 6

### Belgium

please see Kuhnke Netherlands

### Canada

Kuhnke Automation, Inc.  
P.O. Box 1369  
Wayne, N.J. 07474-1369  
Phone (cc 001) 973 633 0690  
Fax (cc 001) 973 633 7230

### Chile

Electronica Industrial Schädler y  
Cia. Ltda.  
Casilla 189 - 9  
6641545 Santiago  
Phone (cc 56) 2 274 74 30  
Fax (cc 56) 2 204 93 38

### Croatia

please see Kuhnke Austria

### Cyprus

Nissad Development Co.Ltd.  
10 Mykenae Street  
1306 Nicosia  
Phone (cc 357) 2 76 50 14  
Fax (cc 357) 2 76 15 35

### Czech Republic

please see Kuhnke Austria

### Denmark

J.D. Friederichsen A/S  
Sydmarken 46  
2860 Søborg  
Phone (cc 45) 70 27 23 27  
Fax (cc 45) 70 27 23 37

### Finland

Oy E. Sarlin AB  
Kaivokselantie 3-5  
200 Helsinki  
Phone (cc 358) 9 50 44 41  
Fax (cc 358) 9 563 32 27

### France

Kuhnke Pneumatic S.A.R.L.  
La Croix Rouge  
35530 Brécé  
Phone (cc 33) 2 99 00 28 98  
Fax (cc 33) 2 99 00 25 85

### Germany

Kuhnke GmbH  
Strohgäustraße 3  
73765 Neuhausen  
Phone (cc 49) 7158 90 74 0  
Fax (cc 49) 7158 90 74 80

### Greece

Tsilakopoulos Electronics Ltd.  
Athanasiou Asteriou 31  
60100 Katerini  
Phone (cc 30) 51 279 02  
Fax (cc 30) 51 261 75

### Hungary

please see Kuhnke Austria

### Israel

Tapuz K.S. Import & Export Ltd  
5 Hasadan St. Holon  
Holon 58152  
Phone (cc 972) 3 559 42 01  
Fax (cc 972) 3 558 42 98

### Italy

SIEI Peterlongo S.p.A.  
Via Lomellina 41  
20133 Milano  
Phone (cc 39) 02 7 52 2 1  
Fax (cc 39) 02 752 22 22

### Korea

Euroko Trading Ltd.  
2nd Floor, Bora Building  
70-1, Shinkil 1-dong  
Youngdeungpo-ku  
Seoul  
Phone (cc 82) 2 836 26 02  
Fax (cc 82) 2 836 26 04

### Malaysia

please see Kuhnke Australia

### Mexico

Kuhnke Automation, Inc.  
P.O. Box 1369  
Wayne, N.J. 07474-1369  
Phone (cc 001) 973 633 0690  
Fax (cc 001) 973 633 7230

### Morocco

please see Kuhnke France

### Netherlands

Stuifmeel Techniek bv  
Industrieterrein Noordersluis  
Zeilweg 32  
8243 PK Lelystad  
Phone (cc 31) 320 27 74 11  
Fax (cc 31) 320 26 06 88

### Norway

Elteco AS  
Floodmyrveien 24  
3901 Porsgrunn  
Phone (cc 47) 35 573 8 00  
Fax (cc 47) 35 573 8 49

### Peru

Somerinca Sa  
Av Tingo Maria - 888  
Lima 1  
Phone (cc 51) 1 3370048  
Fax (cc 51) 1 3370053

### Poland

Welzer Industrievertretungen  
Ul. Poznanska 70  
62-040 Puszczkowo/Poznan  
Phone (cc 48) 61 813 39 57  
Fax (cc 48) 61 819 40 58

### Romania

Kuhnke Relee S.R.L.  
Str. Raului 33  
2400 Sibiu  
Phone (cc 40) 69 22 36 53  
Fax (cc 40) 69 23 61 64

### Serbia

please see Kuhnke Austria

### Singapore

Hoerbiger - Origa Pte Ltd.  
5012, #05-01, Ang Mo Kio Ave 5  
Singapore 569876  
Phone (cc 65) 4 83 29 59  
Fax (cc 65) 4 83 29 79

### Slovenia

please see Kuhnke Austria

### South Africa

Avnet Kopp (Pty.) Ltd.  
2128 Rivonia  
Phone (cc 27) 11 444 23 33  
Fax (cc 27) 11 444 17 06

### Spain

Kuhnke c/o Comercial Key S.L.  
Padilla, 216, Entlo 1  
8013 Barcelona  
Phone (cc 34) 93 270 01 75  
Fax (cc 34) 93 265 37 53

### Sweden

Kuhnke Automation AB  
P.O. Box 5025  
Bryggerigatan 7  
29105 Kristianstad  
Phone (cc 46) 44 10 36 60  
Fax (cc 46) 44 10 95 15

### Taiwan

Oarsmen Corporation  
6F - 1, No. 361  
Chung Hwa 2nd Road  
Kaohsiung City  
Phone (cc 886) 2 2885 6713  
Fax (cc 886) 2 2885 6734

### Tunisia

please see Kuhnke France

### Turkey

Else A.S.  
Okçumusa Cad. Günes Han  
No:66 Kat:3  
80020 Karaköy / Istanbul  
Phone (cc 90) 212 254 54 05  
Fax (cc 90) 212 250 65 90

### UK

H. Kuhnke Ltd.  
Unit 21, Abbey Enterprise Centre  
Premier Way  
Romsey, Hampshire SO51 9AQ  
Phone (cc 44) 1794 514 445  
Fax (cc 44) 1794 513 514

### USA

Kuhnke Automation, Inc.  
P.O. Box 1369  
Wayne, N.J. 07474-1369  
Phone (cc 001) 973 633 0690  
Fax (cc 001) 973 633 7230

### Venezuela

Moeller Somerinca  
Dismerinsa  
Edificio Esteban, Piso 2  
Calle Vargas  
76051 Caracas  
Phone (cc 58) 212 2352748  
Fax (cc 58) 212 2385625



### Heavy Duty General Purpose Relays 10 Amp. 2 or 3 Poles

#### Features:

- Industry standard octal type socket.
- Standard version includes mechanical flag, push to test button and override lever (latch to test).
- Easy to read label and diagram.
- Options include LED's and surge suppressors.
- Complete set of sockets and accessories including timing module.
- 4 contact options provide wide switching range.
- All major world standard approvals.

Kuhnke's Universal Relays are heavy duty general purpose devices which fit standard 8 or 11 pin tube type sockets and are interchangeable with similar relays from other manufacturers. Universal Relays are designed for rugged industrial control applications. Standard types are rated 10 amperes, 250 volts maximum, include a mechanical flag, latching lever and push-to-test button. Contacts are made of a silver nickel alloy. Other types include bifurcated (twin) contacts for dusty environments or low power level switching (gold clad). Color coded test buttons help identify coil circuits, red for AC, green for DC.

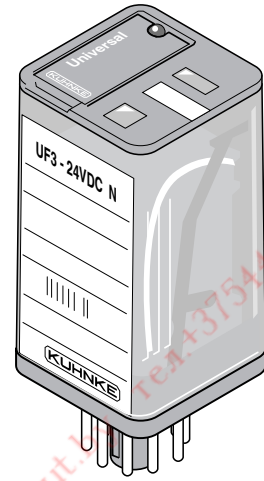

#### General Specifications

<b>Contact Configuration:</b>	<b>DPDT or 3PDT (Form C)</b>
<b>Current Rating-</b>	
<b>Standard Contacts:</b>	<b>10 Amperes</b>
<b>Bifurcated Contacts:</b>	<b>4 Amperes</b>
<b>Gold Clad Contacts:</b>	<b>Min. 1 mA @ 100 mV DC</b>
<b>Max. Voltage:</b>	<b>250 Volts AC</b>
<b>Horsepower Rating:</b>	<b>1/4 @ 120 V / 1/3 @ 240 V</b>
<b>Coil Pwr. Consumption:</b>	<b>1.5 W (DC), 2.5 VA (AC)</b>
<b>Oper. Time (approx.):</b>	<b>Pick-up - 12 ms</b>
	<b>Drop-out - 10 ms</b>
<b>Weight without socket:</b>	<b>3 oz. (90 g)</b>
<b>Overall Dimensions:</b>	<b>2 3/4" High x 1 3/8" Sq.</b>

For complete specifications see page 23.

#### Catalog Numbering System

Typical Catalog Number:

<b>UF</b>	<b>3</b>	<b>G</b>	<b>-</b>	<b>120VAC</b>	<b>1L</b>
Relay Type	No. of Contacts (2 or 3 Pole)	Contact Material (See Below)		Coil Voltage	Options (See Below)

**Contact Materials:**  
**No code Letter** - Standard Contact, Silver Nickel Alloy.  
**B** - Standard Contact, Silver Nickel with Gold cladding.  
**F** - Bifurcated (Twin) Contacts, Silver Nickel Alloy.  
**G** - Bifurcated Contacts, Silver Nickel with Gold cladding.

**Options (Suffixes):**  
**1** - With mech. flag, push-to-test button and override lever.  
**N** - Without override lever, with mech. flag and test button.  
**F** - With built in surge suppressor (DC -polarity dependent).  
**L** - Including LED (pilot light).



#### Wiring Diagram

2 Pole Relay

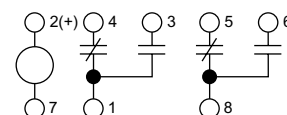

3 Pole Relay

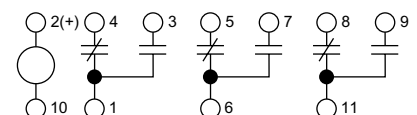

## Quic-Pics Chart – UF Universal Relays

DC Coil Voltages			AC Coil Voltages		
Standard 2 Pole Relays	Standard 3 Pole Relays	Special Contact Materials	Standard 2 Pole Relays	Standard 3 Pole Relays	Special Contact Materials
<ul style="list-style-type: none"> <li>• UF2-12VDC1</li> <li>• UF2-24VDC1</li> <li>UF2-24VDC1FL</li> <li>UF2-24VDCN</li> <li>UF2-110VDCN</li> </ul>	<ul style="list-style-type: none"> <li>• UF3-12VDC1</li> <li>UF3-12VDCN</li> <li>• UF3-24VDC1</li> <li>• UF3-24VDC1L</li> <li>• UF3-24VDC1FL</li> <li>UF3-24VDCN</li> <li>UF3-24VDCNF</li> <li>UF3-24VDCNFL</li> <li>UF3-24VDCNL</li> <li>• UF3-48VDCN</li> <li>UF3-60VDCN</li> <li>• UF3-110VDCN</li> <li>UF3-125VDCN</li> </ul>	<ul style="list-style-type: none"> <li>• UF3B-24VDC1</li> <li>UF3B-24VDC1L</li> <li>UF3B-24VDCN</li> <li>• UF3F-24VDC1</li> <li>UF3F-24VDCN</li> <li>UF3F-24VDCNF</li> <li>• UF3G-24VDC1</li> <li>• UF3G-24VDC1L</li> <li>UF3G-24VDC1FL</li> <li>UF3G-24VDCN</li> </ul>	<ul style="list-style-type: none"> <li>• UF2-12VAC1</li> <li>• UF2-24VAC1</li> <li>• UF2-24VAC1L</li> <li>UF2-24VACN</li> <li>• UF2-120VAC1</li> <li>• UF2-120VAC1L</li> <li>• UF2-230VAC1</li> <li>UF2-230VACN</li> </ul>	<ul style="list-style-type: none"> <li>• UF3-12VAC1</li> <li>• UF3-24VAC1</li> <li>• UF3-24VAC1L</li> <li>UF3-24VACN</li> <li>• UF3-120VAC1</li> <li>• UF3-120VAC1L</li> <li>• UF3-230VAC1</li> <li>• UF3-230VAC1L</li> <li>UF3-230VACN</li> <li>UF3-230VACNL</li> </ul>	<ul style="list-style-type: none"> <li>• UF2G-120VAC1</li> <li>UF3B-230VACN</li> <li>UF3F-24VACN</li> <li>UF3F-230VAC1</li> <li>UF3F-230VACN</li> <li>• UF3G-120VAC1</li> <li>• UF3G-120VAC1L</li> <li>UF3G-230VAC1</li> <li>UF3G-230VACN</li> </ul>

(\*) –Denotes normally stocked items, other types available in packages of 10.  
 Not all types of relays are shown. See Catalog Numbering System to select other relay types. Minimum quantities may apply.

## Sockets, Plug-in Modules and Accessories

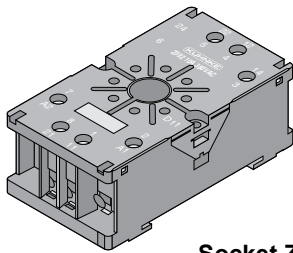

Socket Z392

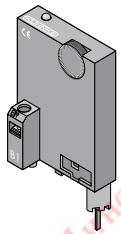

Universal Timer Module Z396-64

Modules for Sockets Z395 and Z396

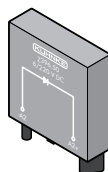

Description	Catalog No.	See Page
Standard Socket, 2 Pole Relay (8 Pin)	Z392	13
Standard Socket, 3 Pole Relay (11 Pin)	Z393	13
Modular Socket, 2 Pole Relay (8 Pin)	Z395	13
Modular Socket, 3 Pole Relay (11 Pin)	Z396	14
<i>for Plug-in Modules:</i>		
Multi-function, Multi Voltage Timing Module	Z396-64	19
Surge Suppressor, 6 to 220 VDC	Z396-50	21
Surge Suppressor and LED for 24 VDC	Z396-52	21
RC Surge Suppressor for 110/230 VAC	Z396-53	21
Varistor, Surge Suppressor for 24 VAC	Z396-54	21
Varistor, Surge Suppressor for 230 VAC	Z396-55	21
LED 110/230 VAC	Z396-58	21
Modular Socket, 2 Pole Relay	Z347	14
Modular Socket, 3 Pole Relay	Z348	14
<i>for Plug-in Modules:</i>		
Surge Suppressor and LED for 24 VDC	Z316-51	21
LED for 24 VDC	Z316-52	21
Surge Suppressor, 6 to 220 VDC	Z316-53	21
Varistor, Surge Suppressor for 24 VAC	Z316-54	21
Varistor, Surge Suppressor for 230 VAC	Z316-55	21
Varistor, Surge Sup. and LED 230 VAC	Z316-58	21
Euro Standard Socket (3 Pole)	Z345	15
Euro Standard Socket (3 Pole) w/Surge Sup. DC	Z345-12	15
Euro Standard Socket (3 Pole) w/Surge Sup. AC	Z345-32	15
Retaining Clip (wire bail) for Z392 or Z393	Z434	—
Retaining Clip (wire bail) for Z347, Z348, Z345	Z441	—
Relay marking tabs, 100 per sheet	Z535	—

Note: All sockets are equipped for panel or DIN rail mounting and have finger proof screw terminals. Modules which incorporate timing, visual indication and surge suppression can be added to bases.

# Type UB

## Universal Relays™

Kuhnke Modular Relay Group

### Square Base General Purpose Relays 10 Amp. 2 or 3 Poles, Blade Type

#### Features:

- Industry standard, square base relay.
- Blade base provides for solder, fast-on wire terminal or socket connections.
- Standard version includes mechanical flag, push-to-test button and override lever.
- Options include LED's and surge suppressors.
- 4 contact options provide wide switching range.
- All major world standard approvals.

Kuhnke's Universal Square Base Relays are heavy duty general purpose devices with the same features as tube type relays (octal socket-UF), except are equipped with blade style terminals which can be soldered or connected with fast-on wire terminals in addition to being used in relay sockets. Relays are interchangeable with similar relays from other manufacturers.

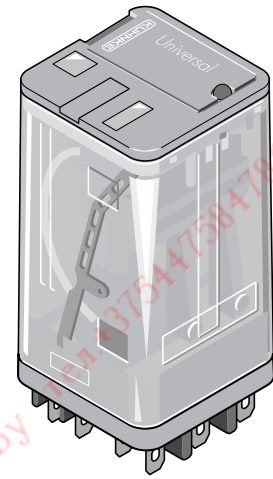

#### General Specifications

<b>Contact Configuration:</b>	<b>DPDT or 3PDT (Form C)</b>
<b>Current Rating-</b>	
<b>Standard Contacts:</b>	<b>10 Amperes</b>
<b>Bifurcated Contacts:</b>	<b>4 Amperes</b>
<b>Gold Clad Contacts:</b>	<b>Min. 1 mA @ 100 mV DC</b>
<b>Max. Voltage:</b>	<b>250 Volts AC</b>
<b>Horsepower Rating:</b>	<b>1/4 @ 120V / 1/3 @ 240 V</b>
<b>Coil Pwr. Consumption:</b>	<b>1.5 W (DC), 2.5 VA (AC)</b>
<b>Oper. Time (approx.):</b>	<b>Pick-up - 12 ms</b>
	<b>Drop-out - 10 ms</b>
<b>Weight without socket:</b>	<b>3 oz. (90 g)</b>
<b>Overall Dimensions:</b>	<b>2 3/8" High x 1 3/8" Sq.</b>

For complete specifications see page 23.

#### Catalog Numbering System

Typical Catalog Number:

<b>UB</b>	<b>3</b>	<b>G</b>	<b>-</b>	<b>120VAC</b>	<b>1L</b>
Relay Type	No. of Contacts (2 or 3 Pole)	Contact Material (See Below)		Coil Voltage	Options (See Below)

#### Contact Materials:

- No code Letter** -Standard Contact, Silver Nickel Alloy.
- B** -Standard Contact, Silver Nickel with Gold cladding.
- F** -Bifurcated (Twin) Contacts, Silver Nickel Alloy.
- G** -Bifurcated Contacts, Silver Nickel with Gold cladding.

#### Options (Suffixes):

- 1** -With mech. flag, push-to-test button and override lever.
- N** -Without override lever, with mech. flag and test button.
- F** - With built in surge suppressor (DC -polarity dependent).
- L** - Including LED (pilot light).



#### Wiring Diagram

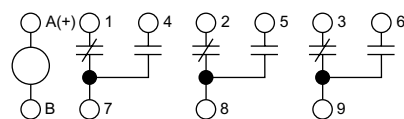

3 Pole relay shown. For 2 pole, omit center contact (terminals 8-2-5)



## Quic-Pics Chart – UB Universal Relays

DC Coil Voltages			AC Coil Voltages		
Standard 2 Pole Relays	Standard 3 Pole Relays	Special Contact Materials	Standard 2 Pole Relays	Standard 3 Pole Relays	Special Contact Materials
UB2-12VDC1 UB2-24VDC1 UB2-24VDC1L	UB3-12VDC1 • UB3-24VDC1 UB3-24VDC1L	UB3G-24VDC1 UB3G-24VDC1L	UB2-24VAC1 UB2-120VAC1 UB2-120VAC1L	UB3-24VAC1 • UB3-120VAC1 UB3-120VAC1L UB3-230VAC1	UB3G-120VAC1 UB3G-120VAC1L

(•) –Denotes normally stocked items, other types available in packages of 10.  
Not all types of relays are shown. See Catalog Numbering System to select other relay types. Minimum quantities may apply.

### Blade Terminal Dimensions

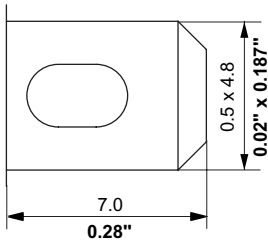

Accepts Faston 187 Quick Connect wire terminals or equal.

### Sockets and Accessories

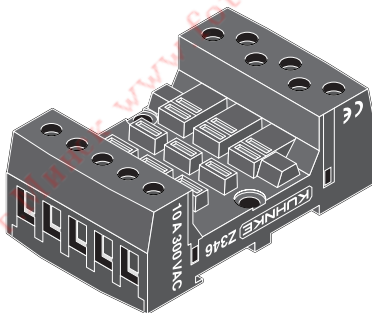

Z346 Socket

Description	Catalog No.	See Page
Standard Socket (accepts 2 or 3 pole relays)	Z346	15
Flange Mounting Bracket	Z556	15
Retaining Clip (wire bail) for Z346	Z441	—
Relay marking tabs, 100 per sheet	Z535	—

Note: Socket is equipped for panel or DIN rail mounting and has finger proof screw terminals.

# Type 114

## Quattro Relays™

Kuhnke Modular Relay Group

### Heavy Duty Ice Cube Relays 10 Amp. 4 Pole

#### Features:

- Wide switching range- 10 mA to 10 Ampere.
- Interchangeable with 3 or 5 Amp. Ice Cube Relays (fits same socket \*).
- Economical solution – covers 90% of control relaying requirements.
- Includes mechanical flag, push-to-test button and override lever (latch to test).
- Complete set of sockets and accessories.
- All major world standard approvals.

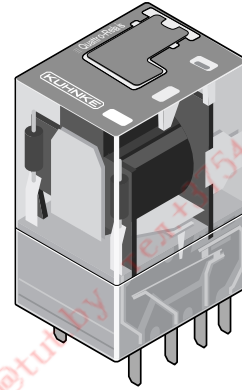

The Quattro Relay is a new concept in miniature relay construction providing an economical solution to most control switching functions used today. Kuhnke's new 114 relay is the same physical size as a 3 or 5 Amp. 4 pole Ice Cube relay (fits same socket\*), but has a 10 Ampere max. rating, yet is able to switch currents as low as 10 mA, 5 volts. New contact materials, solderless circuit paths and individual contact chambers contribute to this relay's wide range of applications. Standard relays include a push-to-test button, a mechanical flag and a latch-to-test lever. Options include LED's and built in surge suppressors. Relays have color-coded test buttons to help identify coil circuits, red for AC, green for DC.

#### General Specifications

<b>Contact Configuration:</b>	<b>4PDT (Form C)</b>
<b>Current Rating-</b>	
<b>Minimum:</b>	<b>10 mA at 5 Volts</b>
<b>Maximum:</b>	<b>10 Amperes</b>
<b>Maximum Voltage:</b>	<b>110 VDC / 250 VAC</b>
<b>Coil Pwr. Consumption:</b>	<b>1.2 VA (AC), 1 W (DC)</b>
<b>Oper. Time (approx.):</b>	<b>Pick-up – 10 ms</b>
	<b>Drop-out – 10 ms</b>
<b>Weight without socket:</b>	<b>1 oz. (33 g)</b>
<b>Overall Dimensions:</b>	<b>1¾" H. x 7⁄8" W. x 1½" D.</b>

For complete specifications see page 25.

#### Catalog Numbering System

Typical Catalog Number:

<b>114A</b>	<b>4</b>	<b>- 120VAC</b>	<b>1L</b>
Relay Type	No. of Contacts	Coil Voltage	Options (See Below)

#### Options (Suffixes):

- 1- With mech. flag, push-to-test button and override lever.
- N- Without override lever, with mech. flag and test button.
- F1- With surge supp. DC (+) at term. 13(A1) (Standard).
- F- With surge supp. DC (+) at term. 14(A2) (Optional).
- L- Including LED (pilot light).



#### Wiring Diagram

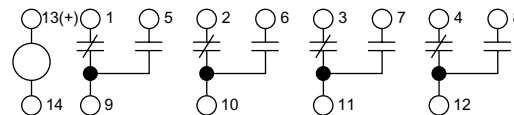

\* When using the Quattro Relay for applications with a rating higher than 5 Amperes, check the rating of the socket. Most sockets for Ice Cube relays are rated 7A. Max. Kuhnke's sockets Z376-02 and Z366-02 are rated at 10 Amps.

### Quic-Pics Chart – Quattro Relays

DC Coil Voltages		AC Coil Voltages	
•114A4-12VDC1 114A4-12VDC1L 114A4-12VDCN •114A4-24VDC1 •114A4-24VDC1L 114A4-24VDC1F1 114A4-24VDCN 114A4-24VDCNF	114A4-24VDCNFL 114A4-24VDCNF1L 114A4-48VDC1 •114A4-48VDC1L 114A4-48VDCN •114A4-110VDC1 114A4-110VDCN	•114A4-12VAC1 •114A4-24VAC1 •114A4-24VAC1L 114A4-24VACN 114A4-48VACN •114A4-120VAC1 •114A4-120VAC1L 114A4-120VACN	•114A4-230VAC1 •114A4-230VAC1L 114A4-230VACN 114A4-230VACNL

(\*) –Denotes normally stocked items, other types available in packages of 10.  
Not all types of relays are shown. See Catalog Numbering System to select other relay types. Minimum quantities may apply.

### Sockets, Plug-in Modules and Accessories

Socket  
Z376-02

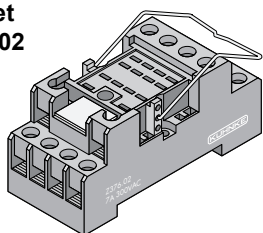

Plug-in Module  
Z376-51

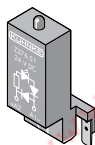

Socket  
Z366-02

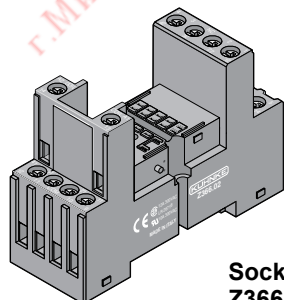

Description	Catalog No.	See Page
Modular Socket, with retaining clip (wire bail), clamp term. for Plug-in Modules:	<b>Z376-02</b>	16
Surge Supp., 6 to 220 VDC (+) at term. 14(A2)	<b>Z376-50</b>	21
Surge Supp., 6 to 220 VDC (+) at term. 13(A1)	<b>Z376-53</b>	21
Surge Supp. and LED, 24 VDC (+) at term. 14(A2)	<b>Z376-51</b>	21
Surge Supp. and LED, 24 VDC (+) at term. 13(A1)	<b>Z376-52</b>	21
Varistor, Surge Suppressor for 230 VAC	<b>Z376-55</b>	21
Varistor, Surge Suppressor for 24 VAC	<b>Z376-54</b>	21
RC Surge Suppressor for 110/230 VAC	<b>Z376-56</b>	21
LED up to 230 VAC	<b>Z376-58</b>	21
Modular Socket, high profile design, clamp terminals for Plug-in Modules:	<b>Z366-02</b>	16
Surge Suppressor, 24 VDC (+) at term. 14(A2)	<b>Z318-50</b>	21
Surge Suppressor, 24 VDC (+) at term. 13(A1)	<b>Z318-53</b>	21
Surge Supp. and LED, 24 VDC (+) at term. 14(A2)	<b>Z318-57</b>	21
Surge Supp. and LED, 24 VDC (+) at term. 13(A1)	<b>Z318-51</b>	21
Varistor, Surge Suppressor for 24 VAC	<b>Z318-54</b>	21
Varistor, Surge Suppressor for 230 VAC	<b>Z318-55</b>	21
LED for 24 VAC/DC	<b>Z318-52</b>	21
LED up to 230 VAC	<b>Z318-58</b>	21
Relay Retaining Clip, plastic for Z366-02 socket	<b>Z366-80</b>	16

Note: All sockets are equipped for panel or DIN rail mounting and have finger proof screw terminals. Modules which incorporate visual indication and surge suppression can be added to bases.

# Type 111

## Miniatur Relays™

Kuhnke Modular Relay Group

### Ice Cube Relays 5 Amp. 2 and 4 Pole

#### Features:

- Fits standard 4 pole Ice Cube Relay Socket.
- Standard version includes mechanical flag, push to test button and override lever (latch to test).
- Fast operating times.
- Options include LED's and surge suppressors.
- Complete set of sockets and accessories.
- All major world standard approvals.

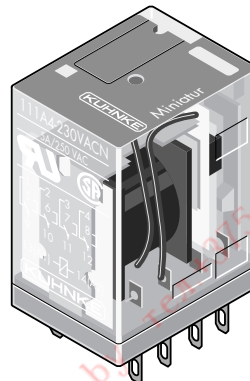

The Miniatur Relay is a general purpose 5 Amp. relay which can be used for process control interface as well as light load switching in machines and signaling circuits. Both the 2 and 4 pole versions fit the standard 4-pole socket. Contacts are made from a silver-nickel alloy for long contact life. Standard relays include a push-to-test button, a mechanical flag and a latch-to-test lever. Options include LED's and built in surge suppressors. Relays have color-coded test buttons to help identify coil circuits, red for AC, blue for DC.

#### General Specifications

<b>Contact Configuration:</b>	<b>DPDT or 4PDT (Form C)</b>
<b>Current Rating-</b>	
<b>Minimum:</b>	<b>50 mA at 20 V DC</b>
<b>Maximum:</b>	<b>5 Amperes</b>
<b>Maximum Voltage:</b>	<b>250 V AC</b>
<b>Coil Pwr. Consumption:</b>	<b>1.6 VA (AC), 1 W (DC)</b>
<b>Oper. Time (approx.):</b>	<b>Pick-up – 10 ms</b>
	<b>Drop-out – 8 ms</b>
<b>Weight without socket:</b>	<b>.6 oz. (20 g) approx.</b>
<b>Overall Dimensions:</b>	<b>1 3/4" H. x 7/8" W. x 1 1/8" D.</b>

For complete specifications see page 27.

#### Catalog Numbering System

Typical Catalog Number:

<b>111</b>	<b>A4</b>	<b>- 120VAC</b>	<b>1L</b>
Relay Type	No. of Contacts B2-2 Pole A4-4 Pole	Coil Voltage	Options (See Below)

#### Options (Suffixes):

- 1- With mech. flag, push-to-test button and override lever.
- N- Without override lever, with mech. flag and test button.
- F- With surge suppressor DC (+) at term. 13(A1).
- L- Including LED (pilot light).



#### Wiring Diagram

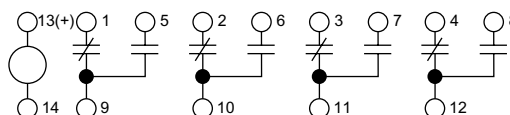

### Quic-Pics Chart – Miniatur Relays

DC Coil Voltages		AC Coil Voltages	
2 Pole	4 Pole	2 Pole	4 Pole
111B2-12VDC1 •111B2-24VDC1 111B2-24VDCN	111A4-12VDC1 111A4-24VDC1 111A4-24VDC1L 111A4-48VDC1 •111A4-48VDC1L •111A4-110VDC1 111A4-110VDCN 111A4-110VDC1L	111B2-12VAC1 •111B2-24VAC1 •111B2-120VAC1 111B2-230VAC1	•111A4-12VAC1 •111A4-24VAC1 111A4-24VAC1L 111A4-48VAC1 111A4-48VACN •111A4-120VAC1 •111A4-120VAC1L •111A4-230VAC1 111A4-230VACN

(•) –Denotes normally stocked items, other types available in packages of 10.  
 Not all types of relays are shown. See Catalog Numbering System to select other relay types. Minimum quantities may apply. See also “Quattro Relays”.

### Sockets, Plug-in Modules and Accessories

Socket  
Z376-02

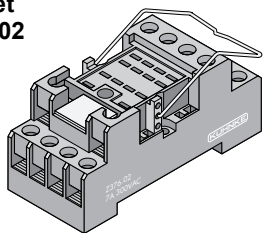

Plug-in Module  
Z376-51

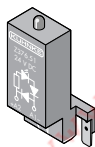

Socket  
Z366-02

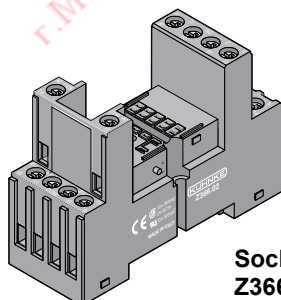

Description	Catalog No.	See Page
Modular Socket, with retaining clip (wire bail), clamp term. <i>for Plug-in Modules:</i>	<b>Z376-02</b>	16
Surge Supp., 6 to 220 VDC (+) at term. 14(A2)	<b>Z376-50</b>	21
Surge Supp., 6 to 220 VDC (+) at term. 13(A1)	<b>Z376-53</b>	21
Surge Supp. and LED, 24 VDC (+) at term. 14(A2)	<b>Z376-51</b>	21
Surge Supp. and LED, 24 VDC (+) at term. 13(A1)	<b>Z376-52</b>	21
Varistor, Surge Suppressor for 230 VAC	<b>Z376-55</b>	21
Varistor, Surge Suppressor for 24 VAC	<b>Z376-54</b>	21
RC Surge Suppressor for 110/230 VAC	<b>Z376-56</b>	21
LED up to 230 VAC	<b>Z376-58</b>	21
Modular Socket, high profile design, clamp terminals <i>for Plug-in Modules:</i>	<b>Z366-02</b>	16
Surge Suppressor, 24 VDC (+) at term. 14(A2)	<b>Z318-50</b>	21
Surge Suppressor, 24 VDC (+) at term. 13(A1)	<b>Z318-53</b>	21
Surge Supp. and LED, 24 VDC (+) at term. 14(A2)	<b>Z318-57</b>	21
Surge Supp. and LED, 24 VDC (+) at term. 13(A1)	<b>Z318-51</b>	21
Varistor, Surge Suppressor for 24 VAC	<b>Z318-54</b>	21
Varistor, Surge Suppressor for 230 VAC	<b>Z318-55</b>	21
LED for 24 VAC/DC	<b>Z318-52</b>	21
LED up to 230 VAC	<b>Z318-58</b>	21
Relay Retaining Clip, plastic for Z366-02 socket	<b>Z366-80</b>	16

Note: All sockets are equipped for panel or DIN rail mounting and have finger proof screw terminals. Modules which incorporate visual indication and surge suppression can be added to bases.



# Type 107

## PCB Interface Relays

Kuhnke Modular Relay Group

### High Performance PCB Interface Relays, DC Operated Up to 16 Amp. 1 or 2 Pole, H.P. Rated

#### Features:

- Size allows for compact stacking of PLC outputs.
- Current ratings up to 16 Amperes.
- Lower power consumption.
- Complete set of sockets and accessories gives PCB relay "Plug-in" ability.
- All major world standard approvals.

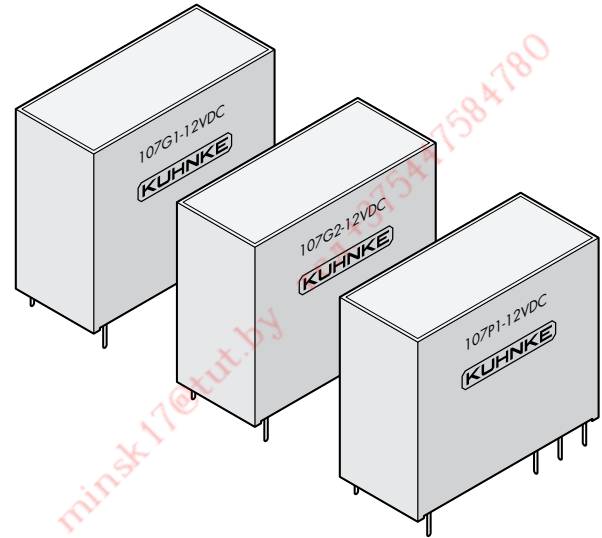

The 107 High Performance printed circuit board relay is ideal for interface applications between industrial controllers and working devices like motor starters, small motors or valves. Because of small power consumption these relays are ideal for use with low output level processors. Plug-in bases allow for standard wiring methods to be used and relays can be stacked in small spaces. Relays are available with 3 different ampere ratings and are horsepower rated.

#### General Specifications

<b>Contact Configuration:</b>	<b>SPDT or DPDT (Form C)</b>
<b>Current Rating-</b>	
<b>Minimum:</b>	<b>100 mA at 5 V DC</b>
<b>Maximum:</b>	<b>5, 10 or 16 Amperes</b>
<b>Maximum Voltage:</b>	<b>150 V DC / 250 V AC</b>
<b>Horsepower Rating-</b>	
<b>107G2:</b>	<b>1/6 HP @ 120/240 VAC</b>
<b>107G1/P1:</b>	<b>1/3 HP @ 120/240 VAC</b>
<b>Coil Pwr. Consumption:</b>	<b>.7 W (DC)</b>
<b>Oper. Time (approx.):</b>	<b>Pick-up – 10 ms (P1-20ms) Drop-out – 5 ms (P1-10ms)</b>
<b>Weight without socket:</b>	<b>.5 oz. (18 g) approx.</b>
<b>Overall Dimensions:</b>	<b>1 1/8" H. x 1/2" W. x 1 1/8" D.</b>

#### Catalog Numbering System

Typical Catalog Number:

<b>107</b>	<b>G2</b>	<b>- 24VDC</b>	<b>E</b>
Relay Type	Contacts (See Below)	Coil Voltage	Options (See Below)

#### Contacts:

**G2-** DPDT, 5 Amperes, 1/6 HP @120/240 V AC  
**G1-** SPDT, 10 Amperes, 1/3 HP @120/240 V AC  
**P1-** SPDT, 16 Amperes, 1/3 HP @120/240 V AC

#### Options (Suffixes):

**E-** Relay with high resistance coil.  
**W-** Washable (when used on PCB boards).

For complete specifications see page 29.



#### Wiring Diagram

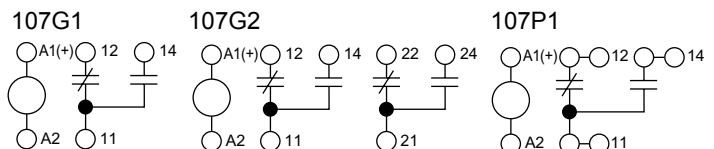

See socket diagram for jumper instructions.

### Quic-Pics Chart – High Performance PCB Interface Relays (DC Operated)

107G2, DPDT, 5 Ampere Max. (1/6 HP @ 120/240 V AC)	107G1, SPDT, 10 Ampere Max. (1/3 HP @ 120/240 V AC)	107P1, SPDT, 16 Ampere Max. (1/3 HP @ 125/250 V AC)
<ul style="list-style-type: none"> <li>•107G2-12VDC</li> <li>•107G2-24VDC</li> <li>107G2-24VDC EW</li> <li>107G2-48VDC</li> <li>107G2-12VDC E</li> <li>•107G2-24VDC E</li> </ul>	<ul style="list-style-type: none"> <li>•107G1-12VDC</li> <li>•107G1-24VDC</li> <li>•107G1-24VDC E</li> </ul>	<ul style="list-style-type: none"> <li>•107P1-12VDC</li> <li>107P1-12VDC E</li> <li>•107P1-24VDC</li> <li>107P1-24VDC E</li> </ul>

(•) –Denotes normally stocked items, other types available in packages of 25.  
 Not all types of relays are shown. See Catalog Numbering System to select other relay types. Minimum quantities may apply.

### Sockets, Plug-in Modules and Accessories

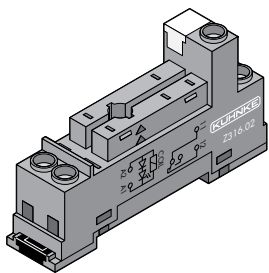

**Socket  
Z316-02**

**Plug-in Module  
Z318-51**

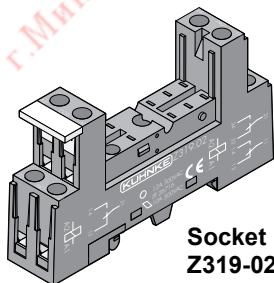

**Socket  
Z319-02**

Description	Catalog No.	See Page
Modular Socket, for 107G1 relay	<b>Z316-02</b>	17
Modular Socket, for 107G2 and 107P1 relay	<b>Z317-02</b>	17
<i>for Plug-in Modules:</i>		
LED for 24 V DC	<b>Z316-52</b>	21
Surge Supp., 24 V DC (+) at term. (A1)	<b>Z316-53</b>	21
Surge Supp. and LED, 24 VDC (+) at term. (A1)	<b>Z316-51</b>	21
Modular Socket, for 107G1 relay , high profile design	<b>Z318-02</b>	18
Modular Socket, for 107G2/P1 relay, high profile design	<b>Z319-02</b>	18
<i>for Plug-in Modules:</i>		
Surge Suppressor, 24 VDC (+) at term. (A2)	<b>Z318-50</b>	21
Surge Suppressor, 24 VDC (+) at term. (A1)	<b>Z318-53</b>	21
Surge Supp. and LED, 24 VDC (+) at term. (A2)	<b>Z318-57</b>	21
Surge Supp. and LED, 24 VDC (+) at term. (A1)	<b>Z318-51</b>	21
LED for 24 V DC	<b>Z318-52</b>	21
Retaining Clip, plastic for Z319-02 socket (107G2/P1 relays only)	<b>Z439</b>	18
Retaining Clip (wire bail) for Z316-02 or Z317-02 sockets	<b>Z429</b>	—

*Note: All sockets are equipped for panel or DIN rail mounting and have finger proof screw terminals. Modules which incorporate visual indication and surge suppression can be added to bases.*

# Type 171

## PCB Interface Relays

Kuhnke Modular Relay Group

## Power PCB Interface Relays Up to 16 Amp. 1 or 2 Pole, H.P. Rated

### Features:

- Size allows for compact stacking of PLC outputs.
- AC or DC operating coils.
- Current ratings up to 16 Amperes.
- Low power consumption.
- Complete set of sockets and accessories gives PCB relay "Plug-in" ability.
- All major world standard approvals.

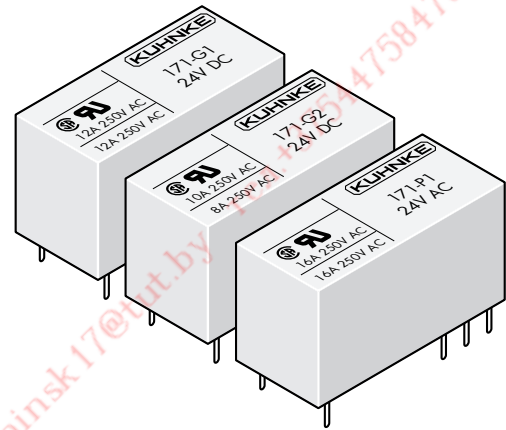

The 171 Power PCB Relay is ideal for interface applications between industrial controllers and working devices like motor starters, small motors or valves. Because of small power consumption these relays are ideal for use with low output level processors. Plug-in bases allow for standard wiring methods to be used and relays can be stacked in small spaces. Relays are available with AC or DC coils and have horsepower ratings.

### General Specifications

<b>Contact Configuration:</b>	<b>SPDT or DPDT (Form C)</b>
<b>Current Rating-</b>	
<b>Minimum:</b>	<b>10 mA at 5 V DC</b>
<b>Maximum:</b>	<b>10, 12 or 16 Amperes</b>
<b>Maximum Voltage:</b>	<b>150 V DC / 250 V AC</b>
<b>Horsepower Rating:</b>	<b>1/3 HP @ 120 V AC</b> <b>3/4 HP @ 240 V AC</b>
<b>Coil Pwr. Consumption:</b>	<b>.4 W (DC), .6 VA (AC)</b>
<b>Oper. Time (approx.):</b>	<b>Pick-up – 10 ms</b> <b>Drop-out – 8 ms</b>
<b>Weight without socket:</b>	<b>.4 oz. (14 g) approx.</b>
<b>Overall Dimensions:</b>	<b>3/4" H. x 1/2" W. x 1 1/8" D.</b>

### Catalog Numbering System

Typical Catalog Number:

**171**    **G2**    -    **115VAC**

**Relay Type**    **Contacts (See Below)**    **Coil Voltage**

**Contacts:**  
**G2-** DPDT, 10 Amp., 1/3 HP-120VAC, 3/4 HP -240 VAC.  
**G1-** SPDT, 12 Amp., 1/3 HP-120VAC, 3/4 HP -240 VAC.  
**P1-** SPDT, 16 Amp., 1/3 HP-120VAC, 3/4 HP -240 VAC.

For complete specifications see page 31.



### Wiring Diagram

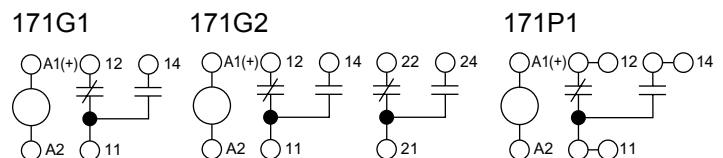

See socket diagram for jumper instructions.

### Quic-Pics Chart – Power PCB Interface Relays

171G2, DPDT, 10 Ampere Max. (1/3 HP- 120 VAC, 3/4 HP- 240 VAC)		171G1, SPDT, 12 Ampere Max. (1/3 HP-120 VAC, 3/4 HP- 240 VAC)		171P1, SPDT, 16 Ampere Max. (1/3 HP-120 VAC, 3/4 HP- 240 VAC)	
DC Coil Voltages	AC Coil Voltages	DC Coil Voltages	AC Coil Voltages	DC Coil Voltages	AC Coil Voltages
•171G2-12VDC •171G2-24VDC	•171G2-24VAC •171G2-115VAC •171G2-230VAC	•171G1-12VDC •171G1-24VDC	•171G1-24VAC •171G1-115VAC •171G1-230VAC	•171P1-12VDC •171P1-24VDC	•171P1-24VAC •171P1-115VAC •171P1-230VAC

(•) –Denotes normally stocked items.

### Sockets, Plug-in Modules and Accessories

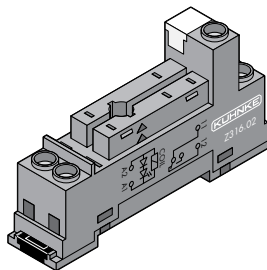

**Socket  
Z316-02**



**Plug-in Module  
Z318-51**

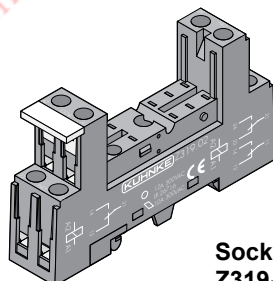

**Socket  
Z319-02**

Description	Catalog No.	See Page
Modular Socket, for 171G1 relay	<b>Z316-02</b>	17
Modular Socket, for 171G2 and 171P1 relay	<b>Z317-02</b>	17
<i>for Plug-in Modules:</i>		
LED for 24 V DC	<b>Z316-52</b>	21
Surge Supp., 24 V DC (+) at term. (A1)	<b>Z316-53</b>	21
Surge Supp. and LED, 24 VDC (+) at term. (A1)	<b>Z316-51</b>	21
Varistor, Surge Suppressor for 115/230 VAC	<b>Z316-55</b>	21
Varistor, Surge Suppressor for 24 VAC	<b>Z316-54</b>	21
Varistor, Surge Supp. and LED 110/230 VAC	<b>Z316-58</b>	21
Modular Socket, for 171G1 relay , high profile design	<b>Z318-02</b>	18
Modular Socket, for 171G2/P1 relay, high profile design	<b>Z319-02</b>	18
<i>for Plug-in Modules:</i>		
Surge Suppressor, 24 VDC (+) at term. (A2)	<b>Z318-50</b>	21
Surge Suppressor, 24 VDC (+) at term. (A1)	<b>Z318-53</b>	21
Surge Supp. and LED, 24 VDC (+) at term. (A2)	<b>Z318-57</b>	21
Surge Supp. and LED, 24 VDC (+) at term. (A1)	<b>Z318-51</b>	21
Varistor, Surge Suppressor for 24 VAC	<b>Z318-54</b>	21
Varistor, Surge Suppressor for 230 VAC	<b>Z318-55</b>	21
LED for 24 VAC/DC	<b>Z318-52</b>	21
LED up to 230 VAC	<b>Z318-58</b>	21
Retaining Clip, plastic for socket Z318-02 or Z319-02	<b>Z438</b>	18

*Note: All sockets are equipped for panel or DIN rail mounting and have finger proof screw terminals. Modules which incorporate visual indication and surge suppression can be added to bases.*

### Z392 Standard 8 Pin Octal Socket for 2 Pole Universal Relays

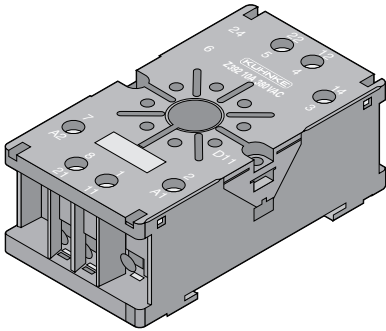

Mounting: DIN rail snap on mount, or panel mounting with (2) #4 or M3 screws  
 Terminals: Clamp with captive screws  
 Wire size: Max. (2) #14 AWG  
 Rating: 10 A 300 V (IEC- 380 V)  
 Weight: 2 oz. (57 g) approx.  
 Dimensions: 2½" High x 1½" Wide x 1⅛" Deep (with relay mounted- 3¾" Deep)  
 Accessories: Z434 Retaining Clip (wire bail)  
 For Relays: UF2

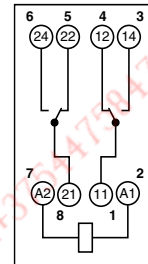

### Z393 Standard 11 Pin Octal Socket for 3 Pole Universal Relays

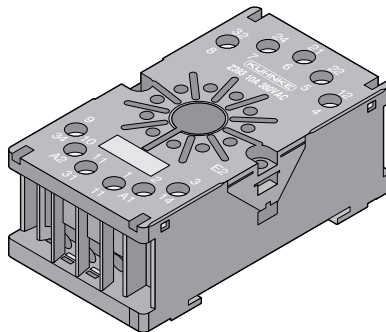

Mounting: DIN rail snap on mount, or panel mounting with (2) #4 or M3 screws  
 Terminals: Clamp with captive screws  
 Wire size: Max. (2) #14 AWG  
 Rating: 10 A 300 V (IEC- 380 V)  
 Weight: 2 oz. (57 g) approx.  
 Dimensions: 2½" High x 1½" Wide x 1⅛" Deep (with relay mounted- 3¾" Deep)  
 Accessories: Z434 Retaining Clip (wire bail)  
 For Relays: UF3

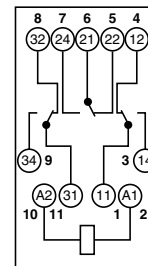

### Z395 Modular 8 Pin Octal Socket for 2 Pole Universal Relays (Accepts all Cat. No. Z396-XX Plug-in Modules)

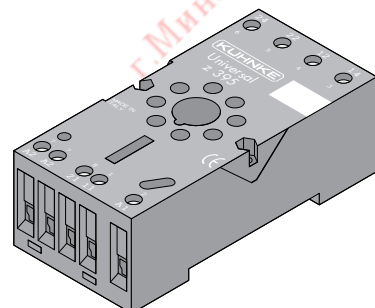

Mounting: DIN rail snap on mount, or panel mounting with (2) #4 or M3 screws  
 Terminals: Clamp with captive screws  
 Wire size: Max. (2) #14 AWG  
 Rating: 10 A 300 V (IEC- 380 V)  
 Weight: 2.2 oz. (62 g) approx.  
 Dimensions: 3" High x 1½" Wide x 1" Deep (with relay mounted- 3¾" Deep)  
 Modules: Accepts all Z396-XX modules for Timing, Indication and Surge Protection, see pages 19-22.  
 For Relays: UF2

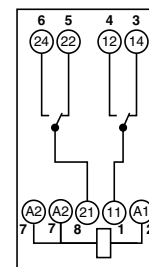



### Modular 11 Pin Octal Socket for 3 Pole Universal Relays (Accepts all Cat. No. Z396-XX Plug-in Modules)

**Z396**

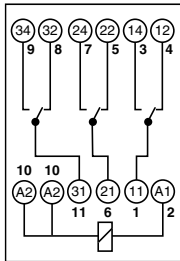

- Mounting: DIN rail snap on mount, or panel mounting with (2) #4 or M3 screws
- Terminals: Clamp with captive screws
- Wire size: Max. (2) #14 AWG
- Rating: 10 A 300 V (IEC- 380 V)
- Weight: 2.2 oz. (62 g) approx.
- Dimensions: 3" High x 1½" Wide x 1" Deep (with relay mounted- 3¾" Deep)
- Modules: Accepts all Z396-XX modules for Timing, Indication and Surge Protection, see pages 19-22.
- For Relays: UF3

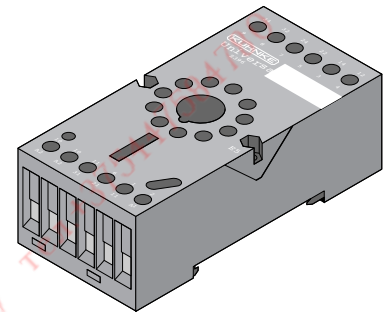

### Modular 8 Pin Octal Socket for 2 Pole Universal Relays (Accepts all Cat. No. Z316-XX Plug-in Modules)

**Z347**

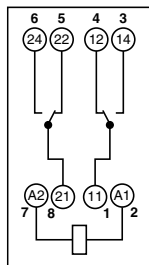

- Mounting: DIN rail snap on mount, or panel mounting with (2) #4 or M3 screws
- Terminals: Clamp with captive screws
- Wire size: Max. (2) #14 AWG
- Rating: 10 A 300 V (IEC- 380 V)
- Weight: 2 oz. (57 g) approx.
- Dimensions: 2⅞" High x 1½" Wide x 1⅞" Deep (with relay mounted- 3⅞" Deep)
- Accessories: Z441 or Z434 Retaining Clip
- Modules: Accepts all Z316-XX modules for Indication and Surge Suppression, see page 21.
- For Relays: UF2

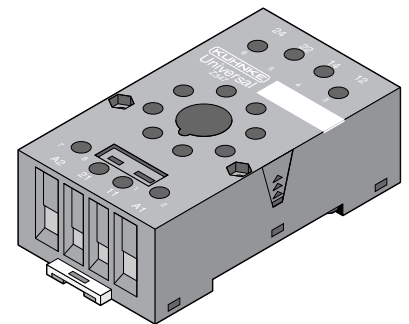

### Modular 11 Pin Octal Socket for 3 Pole Universal Relays (Accepts all Cat. No. Z316-XX Plug-in Modules)

**Z348**

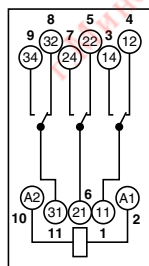

- Mounting: DIN rail snap on mount or panel mounting with (2) #4 or M3 screws
- Terminals: Clamp with captive screws
- Wire size: Max. (2) #14 AWG
- Rating: 10 A 300 V (IEC- 380 V)
- Weight: 2 oz. (57 g) approx.
- Dimensions: 2⅞" High x 1½" Wide x 1⅞" Deep (with relay mounted- 3⅞" Deep)
- Accessories: Z441 or Z434 Retaining Clip
- Modules: Accepts all Z316-XX modules for Indication and Surge Suppression, see page 21.
- For Relays: UF3

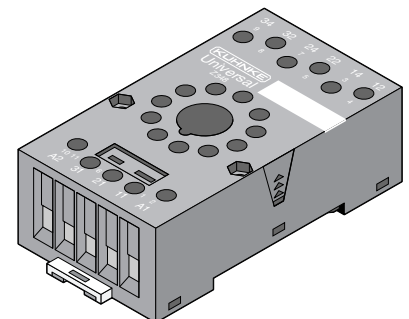

### Z346 Standard Socket for 2 or 3 Pole Square Base (Blade Type) Universal Relays

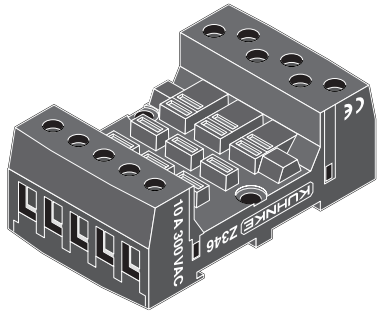

Mounting: DIN rail snap on mount, or panel mounting with (2) #6 or M3.5 screws  
 Terminals: Clamp with captive screws  
 Wire size: Max. (2) #14 AWG  
 Rating: 10 A 300 V  
 Weight: 2.8 oz. (79 g) approx.  
 Dimensions: 2 7/8" High x 1 1/4" Wide x 1" Deep (with relay mounted- 2 7/8" Deep)  
 Accessories: Z441 Retaining Clip (wire bail)  
 For Relays: UB

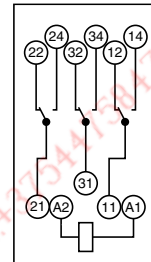

### Z556 Flange Mounting Bracket for Square Base Relays Type UB

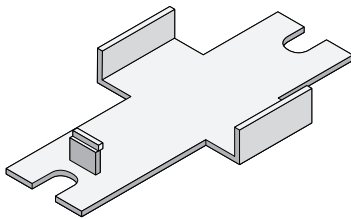

**UB Relay snaps into holder side brackets and locks in place at base of relay.**

Mounting: Bracket mounts with (2) #6 pan head screws on 2 7/8" centers.  
 Material: Plastic  
 Dimensions: 3" High x 1 5/8" Wide  
 For Relays: UB

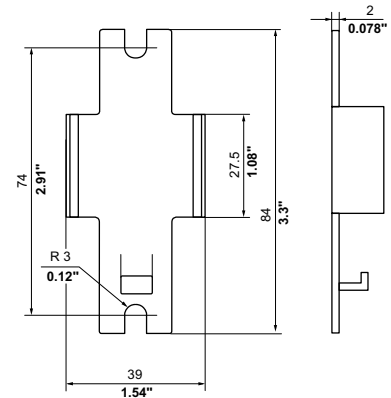

### Z345 Euro 11 Pin Octal Socket for 3 Pole Universal Relays (Special order only, for new installations use Cat. No. Z393)

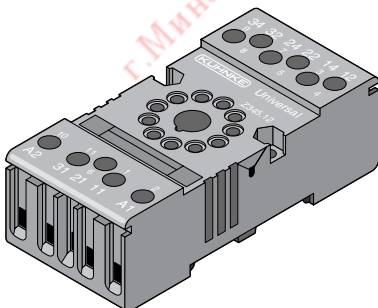

Mounting: DIN rail snap on mount or panel mounting with (2) #4 or M3 screws  
 Terminals: Clamp with captive screws  
 Wire size: Max. (2) #12 AWG  
 Rating: 10 A 380 V  
 Weight: 2.3 oz. (65 g) approx.  
 Dimensions: 3" High x 1 5/8" Wide x 1" Deep (with relay mounted- 3 1/4" Deep)  
 Accessories: Z434 Retaining Clip (wire bail)  
 Other Types: Z345-12, Built-in Surge Suppr. DC  
 Z345-32, Built-in Surge Suppr. AC (RC-230 V max.)  
 For Relays: UF3

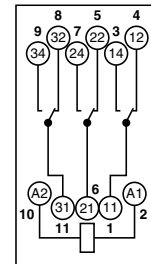

### Modular Socket for 4 Pole (Ice Cube) Quattro Relays (Accepts all Cat. No. Z376-XX Plug-in Modules)

**Z376-02**

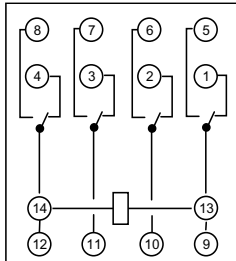

- Mounting: DIN rail snap on mount, or panel mounting with (2) #4 or M3 screws
- Terminals: Clamp with captive screws
- Wire size: Max. (2) #14 AWG
- Rating: 10 A 300 V
- Weight: 1.7 oz. (48 g) approx.
- Dimensions: 2 5/8" High x 1 1/8" Wide x 1 1/8" Deep (with relay mounted-2 1/2" Deep)
- Accessories: Retaining Clip (wire bail) Included
- Modules: Accepts all Z376-XX modules for Indication and Surge Suppression, see page 21.
- For Relays: 114A4 / 111A4-B2

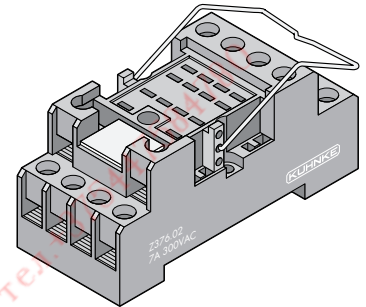

### Modular Socket for 4 Pole (Ice Cube) Quattro Relays (Accepts all Cat. No. Z318-XX Plug-in Modules)

**Z366-02**

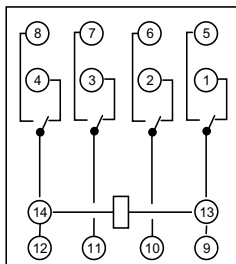

- Mounting: DIN rail snap on mount or panel mounting with (2) #4 or M3 screws
- Terminals: Clamp with captive screws
- Wire size: Max. (2) #14 AWG
- Rating: 10 A 300 V (CSA – 12 A)
- Weight: 2.2 oz. (62 g) approx.
- Dimensions: 3" High x 1 1/8" Wide x 1 3/4" Deep (with relay mounted-2 1/2" Deep)
- Accessories: Retaining Clip Z366-80 (see below)
- Modules: Accepts all Z318-XX modules for Indication and Surge Suppression, see page 21.
- For Relays: 114A4 / 111A4-B2

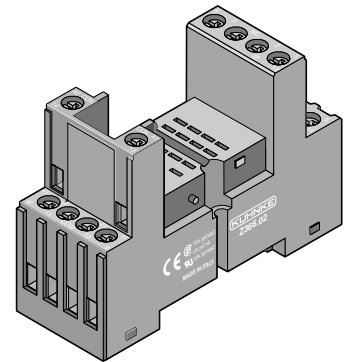

### Retaining Clip for Socket Z366-02 and Quattro Relay

**Z366-80**

- Mounting: Snaps on over pivot points on base
- Uses: Retaining clip and relay ejection tab
- Material: Plastic
- Dimensions: Total depth of base with relay and clip installed is 3 1/4".

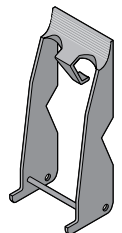

### Z316-02 Modular Socket for PCB Interface Relays- 107/171 G1 (Accepts all Cat. No. Z316-XX Plug-in Modules)

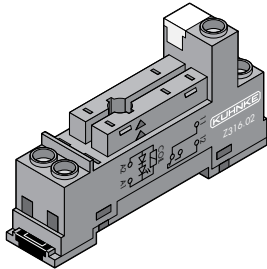

Mounting: DIN rail snap on mount, or panel mounting with (1) #4 or M3 screw  
Terminals: Clamp with captive screws  
Wire size: Max. (2) #14 AWG  
Rating: 10 A 250V  
Weight: .4 oz. (12 g) approx.  
Dimensions: 2 3/4" High x 5/8" Wide x 1 1/2" Deep (with relay mounted- 2" Deep)  
Accessories: Z429 Retaining Clip (107 only)  
Modules: Accepts all Z316-XX modules for Indication and Surge Suppression, see page 21.  
For Relays: 107G1, 171G1

  IEC VDE

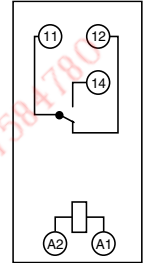

### Z317-02 Modular Socket for PCB Interface Relays- 107/171 G2 and P1 (Accepts all Cat. No. Z316-XX Plug-in Modules)

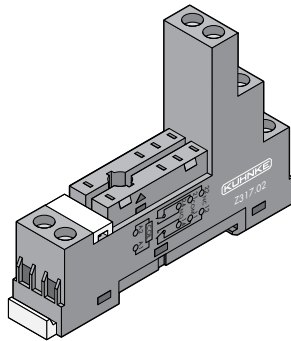

Mounting: DIN rail snap on mount, or panel mounting with (1) #4 or M3 screw  
Terminals: Clamp with captive screws  
Wire size: Max. (2) #14 AWG  
Rating: 10 A 250 V  
Weight: .8 oz. (22 g) approx.  
Dimensions: 3" High x 5/8" Wide x 2 1/8" Deep (with relay mounted- 2 1/8" Deep)  
Modules: Accepts all Z316-XX modules for Indication and Surge Suppression, see page 21.  
Accessories: Z429 Retaining Clip (107 only)  
For Relays: 107G2, 107P1, 171G2, 171P1

  IEC VDE

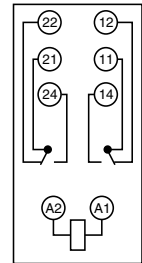

For 171P1 – Jumpers are required between terminals 11-21, 12-22 and 14-24 when contact load exceeds 10 Amperes.

### Modular Socket for PCB Interface Relays- 107/171 G1 Z318-02 (Accepts all Cat. No. Z318-XX Plug-in Modules)

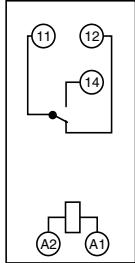

- Mounting: DIN rail snap on mount, or panel mounting with (1) #4 or M3 screw
- Terminals: Clamp with captive screws
- Wire size: Max. (2) #14 AWG
- Rating: 10 A 300 V (CSA- 12 A)
- Weight: .6 oz. (17 g) approx.
- Dimensions: 3" High x 5/8" Wide x 1 1/4" Deep (with relay mounted- 2 1/8" Deep)
- Accessories: Retaining Clip- (see below)
- Modules: Accepts all Z318-XX modules for Indication and Surge Suppression, see page 21.
- For Relays: 107G1, 171G1

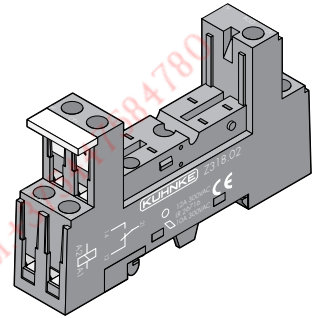

### Modular Socket for PCB Interface Relays- 107/171 G2 and P1 Z319-02 (Accepts all Cat. No. Z318-XX Plug-in Modules)

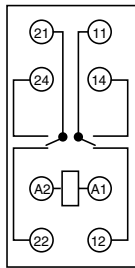

- Mounting: DIN rail snap on mount or panel mounting with (1) #4 or M3 screw
- Terminals: Clamp with captive screws
- Wire size: Max. (2) #14 AWG
- Rating: 10 A 300 V (CSA – 12 A)
- Weight: .8 oz. (22 g) approx.
- Dimensions: 3" High x 5/8" Wide x 1 1/4" Deep (with relay mounted- 2 1/8" Deep)
- Accessories: Retaining Clip (see below)
- Modules: Accepts all Z318-XX modules for Indication and Surge Suppression, see page 21.
- For Relays: 107G2, 107P1, 171G2, 171P1

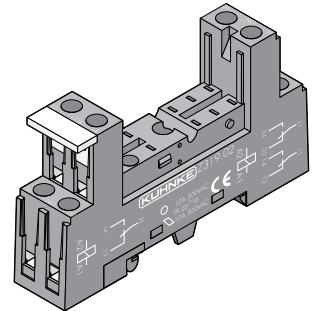

For 171P1 – Jumpers are required between terminals 11-21, 12-22 and 14-24 when contact load exceeds 10 Amperes.

### Retaining Clips for Socket Z318-02 and Z319-02 Sockets Z438 Z439

- Z438** Use with relay 171
- Z439** Use with relay 107G2 and 107P1
- Mounting: Snaps on over pivot points on base
- Uses: Retaining clip and relay ejection tab
- Material: Plastic
- Dimensions: Total Depth of base with relay and clip installed is 2 5/8" for 171 relay and 2 3/4" for 107 relay.

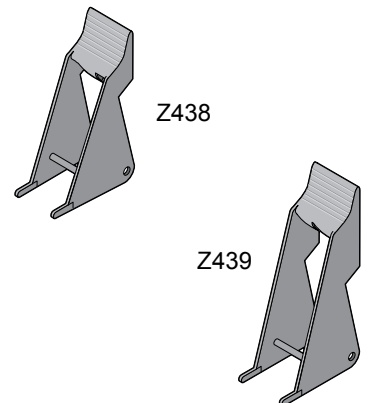



### Universal Timing Module Z396-64

#### Features:

- **Multi-function, Multi-voltage module, eliminates the need for different types of timers**
- **Plugs into base along with standard Universal Relay.**
- **Time ranges from 0.05 seconds to 10 days.**
- **Accepts all line voltages (AC or DC), 24 to 240 Volts.**
- **8 functions- Time Delays, Flashers, Pulse (one shot) etc.**
- **Timing function isolated from relay, allows easy replacement of worn contacts.**

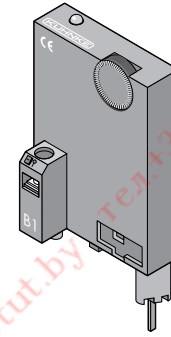

The Universal Timing Module eliminates the need for different types of timers. One unit covers all timer functions and has 8 timing ranges up to 240 hours. The module plugs into base Z395 or Z396 along side a standard Universal Relay with the appropriate line voltage. When mounted on base, the settings are hidden to prevent tampering. Timing functions and time ranges are set via selecting dip-switch positions and a knob adjustment on top allows for fine setting. An LED indicates power on and flashes during timing sequence.

#### Easy Installation

Use relay socket Z395 (for a 2 pole relay) or Z396 (for a 3 pole relay), a Universal Relay with the line voltage needed, and the Universal Timing Module. Select the desired timing function from the chart on the next page, and position the 3 “function” dip-switches on the module as required. Next select the time range required and position the “time” dip-switches to the corresponding time range as shown in the time range chart. Plug the module and the relay into the base and connect wiring as required. Some timing functions require an external start contact connected to terminal B1 on the timing module, all others require only the normal connections to the relay coil. When using DC, always connect the positive lead to terminal A1 (2) and B1, negative to A2 (10). Set and fine-tune the time range by using the yellow graduated dial on the top of the module.

#### Specifications

<b>Voltage Range:</b>	<b>24 to 240 V AC or DC</b>
<b>Frequency (AC):</b>	<b>48 to 63 Hz</b>
<b>Operating Temp. Range:</b>	<b>-25° to 55° C</b>
<b>Power failure bridge time:</b>	<b>10 ms</b>
<b>Recovery time:</b>	<b>Max. 150 ms at 55° C</b>
<b>Repeatability:</b>	<b>1% of set time</b>
<b>Weight:</b>	<b>0.5 oz. (14 g) approx.</b>
<b>Dimensions:</b>	<b>1 7/8" H. x 1 3/8" W. x 3/8" D. (Fits inside dimensions of socket and relay)</b>



#### Time Ranges

Time Range	Dip-Switch Position	Adjustment Range
1 Second	<input type="checkbox"/> <input type="checkbox"/> <input type="checkbox"/> <input checked="" type="checkbox"/> <input checked="" type="checkbox"/> <input checked="" type="checkbox"/>	0.05 to 1 Sec.
10 Seconds	<input type="checkbox"/> <input type="checkbox"/> <input checked="" type="checkbox"/> <input checked="" type="checkbox"/> <input type="checkbox"/> <input type="checkbox"/>	0.5 to 10 Sec.
1 Minute	<input type="checkbox"/> <input checked="" type="checkbox"/> <input type="checkbox"/> <input checked="" type="checkbox"/> <input type="checkbox"/> <input checked="" type="checkbox"/>	3 to 60 Sec.
10 Minutes	<input type="checkbox"/> <input checked="" type="checkbox"/> <input checked="" type="checkbox"/> <input checked="" type="checkbox"/> <input type="checkbox"/> <input type="checkbox"/>	30 to 600 Sec.
1 Hour	<input checked="" type="checkbox"/> <input type="checkbox"/> <input type="checkbox"/> <input type="checkbox"/> <input checked="" type="checkbox"/> <input checked="" type="checkbox"/>	3 to 60 Min.
10 Hours	<input checked="" type="checkbox"/> <input type="checkbox"/> <input type="checkbox"/> <input type="checkbox"/> <input checked="" type="checkbox"/> <input type="checkbox"/>	30 to 600 Min.
1 Day	<input checked="" type="checkbox"/> <input checked="" type="checkbox"/> <input type="checkbox"/> <input type="checkbox"/> <input type="checkbox"/> <input checked="" type="checkbox"/>	1.2 to 24 Hrs.
10 Days	<input checked="" type="checkbox"/> <input checked="" type="checkbox"/> <input checked="" type="checkbox"/> <input type="checkbox"/> <input type="checkbox"/> <input type="checkbox"/>	12 to 240 Hrs.

### Timing Functions, Module Z396-64

Function	Dip-Switch Position	Sequence Diagram*
<b>On Delay Timer (Time delay to pickup -TDPU)</b> Start by applying power to coil terminals A1-A2 (2-10). Timer delays relay operation until set time elapses. Reset by opening coil circuit.	□ □ □ ■ ■ ■ Function Code E	
<b>Off Delay Timer (Time delay to drop out -TDDO)</b> Connect a power supply to the coil terminals A1-A2. Timing will begin when a separate start contact connected to terminal B1 on the timing module, is closed. The relay contacts close and remain closed after the start contact is opened until the set time elapses.	□ □ ■ ■ ■ □ Function Code R	
<b>Pulse on (Switch on Wiper)</b> Connect a power supply to the coil terminals A1-A2. Timing will begin when a separate start contact connected to terminal B1 on the timing module, is closed. The relay contacts close until the set time elapses.	□ ■ □ ■ □ ■ Function Code Ws	
<b>Pulse off (Switch off Wiper)</b> Connect a power supply to the coil terminals A1-A2. Timing will begin after a separate start contact connected to terminal B1 on the timing module is closed and then opened. The relay contacts close until the set time elapses.	□ ■ ■ ■ □ □ Function Code Wa	
<b>One Shot</b> Start by applying power to coil terminals A1-A2 (2-10). Timer closes relay contacts only for the set time. Reset by opening coil circuit.	■ □ ■ □ ■ □ Function Code Wu	
<b>On Delay Timer (with separate start contact)</b> Connect a power supply to the coil terminals A1-A2. Timing will begin when a separate start contact connected to terminal B1 on the timing module, is closed. The relay contacts close only after the set time elapses. The relay contacts open when the start contact is opened.	■ □ □ □ ■ ■ Function Code Es	
<b>Flasher (starting off)</b> Start by applying power to the coil terminals A1-A2 (2-10). After the set time elapses the relay contacts close, again for the set time. Then contacts open also for the same set time. The relay continues to cycle until the power is removed from the coil.	■ ■ □ □ □ ■ Function Code Bp	
<b>Flasher (starting on)</b> Start by applying power to the coil terminals A1-A2 (2-10). Relay contacts close until the set time elapses, then contacts open also for the same set time. The relay continues to cycle until the power is removed from the coil.	■ ■ ■ □ □ □ Function Code Bi	

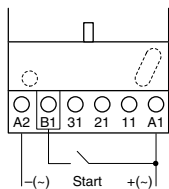

**Timing Module and Relay Socket Power and Control Connections.** See relay socket diagram for contact output connections.

**\* Sequence Diagram Symbols**

- U** – Timer/relay coil power (terminals A1 and A2).
- R** – Relay contact outputs.
- S** – Remote start contact (connected through terminal B1 on module).
- t** – Set time.

### Surge Suppressor and Indicator Modules

#### Features:

- Plugs into base along with standard relays.
- Units for indication as well as surge suppression can be added or changed at any time.
- Wide range for all line voltages and relay types.
- No additional wiring or relay changes required.

Plug-in Modules provide indication of coil status and surge suppression where needed. LED's indicate when the coil circuit is energized, which helps in trouble shooting circuits. Voltage spikes caused by opening of the relay coil circuit can create problems with electronic devices by affecting software programs or the function of the PC or PLC itself. Suppressors limit spikes to a safe level for most electronic devices.

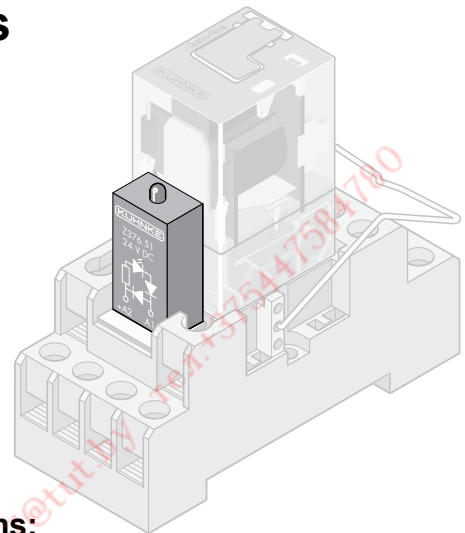

#### Specifications:

- |                               |                               |
|-------------------------------|-------------------------------|
| <b>Voltage range:</b>         | <b>See Chart</b>              |
| <b>Operating Temp. Range:</b> | <b>-25° to 55° C</b>          |
| <b>Connections:</b>           | <b>In parallel with coil.</b> |
| <b>Enclosure:</b>             | <b>Plastic</b>                |
| <b>Weight:</b>                | <b>Less than .3 oz.</b>       |

#### Z396-xx Modules

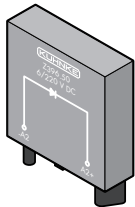

Fits socket Z396. Module plugs in beside relay coil terminals. Units fit inside the dimensions of relay and base, no other space considerations are required.

Dimensions: 1 3/8" x 1 1/8" x 3/8".

#### Z376-xx Modules

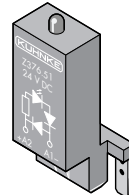

Fits socket Z376. Remove the white marker tab on socket to reveal module connections. Units fit inside the dimensions of relay and base, no other space considerations are required.

Dimensions: 1 3/8" x 1 3/8" x 3/8".

#### Z316-xx Modules

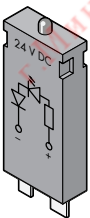

Fits sockets Z347, Z348, Z316-02 and Z317-02. Module plugs in beside relay. When using on base Z317-02, first remove the white marker tab to reveal module connections. Module increases depth dimension of bases Z316-02 and Z317-02 to 2 1/4" and fit inside the dimensions of relay and base for Z347 and Z348 sockets.

Dimensions: 1 3/8" x 5/8" x 1/4".

#### Z318-xx Modules

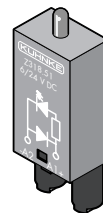

Fits Sockets Z318-02, Z319-02 and Z366-02. Units fit inside the dimensions of relay and base, no other space considerations are required.

Dimensions: 1" x 5/8" x 3/8".

### Quic-Pics Chart Plug-in Modules

Module Description	Fig. No.	Modules plug-in to these sockets-			
		Z395 Z396	Z376-02	Z347/ Z348 Z316-02 Z317-02	Z318-02 Z319-02 Z366-02
<b>LED only (Luminous Diode)</b>					
24 V DC	1	—	—	Z316-52	—
6 to 24 V AC or DC	1	—	—	—	Z318-52
110/230 V AC	1	—	—	—	Z318-58
110/230 V AC	2	Z396-58	Z376-58	—	—
<b>Surge Suppressors DC</b>					
24 V DC Standard Polarity	3	—	—	Z316-53	Z318-53
24 V DC Reverse Polarity	4	—	—	—	Z318-50
6 to 230 V DC Standard Polarity	3	Z396-50	Z376-53	—	—
6 to 220 V DC Reverse Polarity	4	—	Z376-50	—	—
<b>Surge Suppressors AC</b>					
24 V AC Varistor	5	Z396-54	Z376-54	Z316-54	Z318-54
115/230 V AC Varistor	5	Z396-55	Z376-55	Z316-55	Z318-55
Resistor/Capacitor (RC) 120/230 V AC	6	Z396-53	Z376-56	—	—
<b>Combination LED and Surge Suppressor</b>					
24 V DC	7	Z396-52	Z376-52	Z316-51	—
24 V DC Reverse Polarity	8	—	Z376-51	—	—
6 to 24 V DC	7	—	—	—	Z318-51
6 to 24 V DC Reverse Polarity	8	—	—	—	Z318-57
230 V AC with Varistor	9	—	—	Z316-58	—

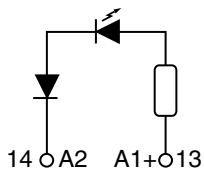

**Fig. 1**  
Luminous Diode (LED)

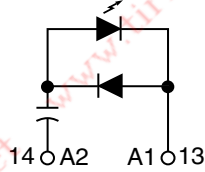

**Fig. 2**  
LED for AC Coil circuits

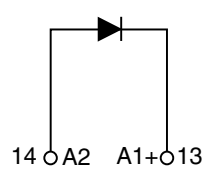

**Fig. 3**  
DC Surge Suppressor  
(Standard Polarity)

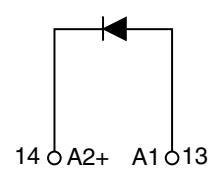

**Fig. 4**  
DC Surge Suppressor  
(Reversed Polarity)

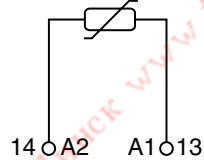

**Fig. 5**  
AC Surge Suppressor  
(Varistor)

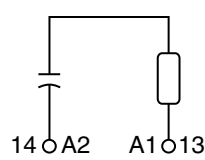

**Fig. 6**  
AC Surge Suppressor  
(Resistor/Capacitor-RC)

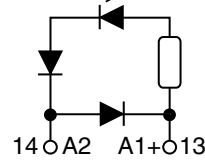

**Fig. 7**  
LED and Surge Suppr.  
DC Circuits (Standard Polarity)

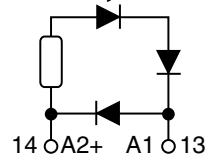

**Fig. 8**  
LED and Surge Suppr.  
DC Circuits (Reverse Polarity)

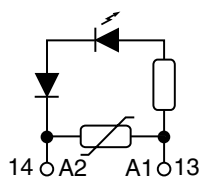

**Fig. 9**  
LED with Varistor AC

# Technical Specifications

## Universal Relays™

Kuhnke Modular Relay Group

## Detailed Specifications UF/UB Relays

### General Information

Number of contacts: 2 or 3 Pole  
 Contact type: Double Throw (Form C)  
 Single or Bifurcated (Twin) contacts  
 Max. Voltage: 250 VAC/DC  
 Current ratings: See Contact Data  
 Weight: 3 oz. (90 grams)

### Performance Information

Pick-up time: 12 ms  
 Drop out time: 10 ms  
 Contact bounce time: 5 ms  
 Mechanical Life: 20 million plus operations  
 Electrical Life: See Charts  
 Operating Ambient Temp: -25°C to +40°C  
 Vibration Resistance: Greater than 4g's  
 Dielectric Strength-  
 Coil to Contact: 2500 VAC  
 Between Poles: 2500 VAC  
 Between open contacts: 1500 VAC

### Standards

UL File: E 41922  
 CSA: LR 47569  
 VDE: According to DIN EN 60255-1-00  
 VDE 0435 part 201  
 IEC: According to IEC255-1-00  
 NEMA: B300 Pilot Duty  
 CE: Low Voltage Directive

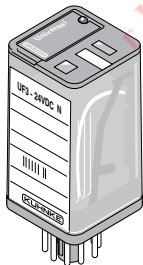

**UF**  
Octal Socket

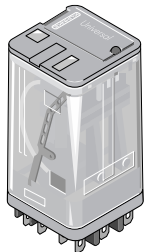

**UB**  
Square Base

### Relay Contact Data

#### Single Contact, Silver Nickel, (AgNi)

##### Standard

Rated Current -Maximum: 10 Amperes  
 -Minimum: 50 mA 20 VDC  
 Max. Inrush Current: 20 A.  
 Max. Switching Cap.(Resistive): 3000 VA  
 Horsepower rating @ 120 VAC: 1/4 HP  
 @ 240 VAC: 1/3 HP

#### Single Contact, Silver Nickel, Gold Clad

##### Cat. Code B

Same as above except min. current: 1 mA 100 mVDC

#### Bifurcated (Twin) contacts, Silver Nickel (AgNi)

##### Cat. Code F

Rated Current -Maximum: 4 Amperes  
 -Minimum: 20 mA 10 VDC  
 Max. Inrush Current: 10A.  
 Max. Switching Cap. (Resistive): 1000 VA

#### Bifurcated (Twin) contacts, Silver Nickel, Gold Clad

##### Cat. Code G

Same as Bifurcated Silver Nickel contacts except min. current: 1 mA 100 mVDC

### Coil Information

Coil Power Consumption-  
 DC: 1.5 W  
 AC: 3 VA 50 Hz/2.5 VA 60 Hz  
 Pull in Power DC: 0.7 W  
 Coil Inrush Current AC: 1.5 x Coil Current  
 Operating Range @ 20°C-  
 DC and AC 50Hz coils: 80 to 110% of rated Voltage  
 AC 60 Hz coils: 85 to 110% of rated Voltage

Voltage	Resistance (Ohms-Ω)	Coil Power Consumption mA	
		60 Hz	50 Hz
AC	24	74	88
	120	2030	17
	230	7500	9.8
DC	12	96	125
	24	384	63
	110	7660	14
	220	30630	7.2



## Detailed Specifications UF/UB Relays

### Estimated Contact Life – AC Loads

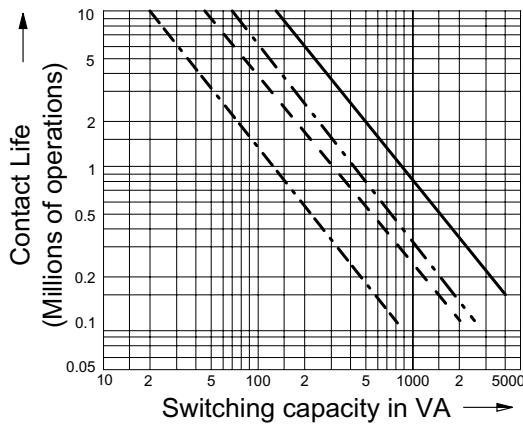

- Resistive Load- Standard Contact
  - - - - - Inductive Load- Standard Contact
  - · - · - Resistive Load- Bifurcated Contact
  - - - - - Inductive Load- Bifurcated Contact
- (Power Factor  $\cos \phi = 0.4$  to  $0.7$ )

The above chart is based on tests at 230 V AC. For lower voltages, reduce contact life by the percentage difference in line voltage.  
 Example: For 1000 VA @ 115 V, (standard contact, resistive load), the contact life is 800K operations at 230V. ( $115V \div 230 = .5$  or 50%). Therefore the contact life at 115V is estimated at 400K operations.

### DC Loads – Contact Capacity

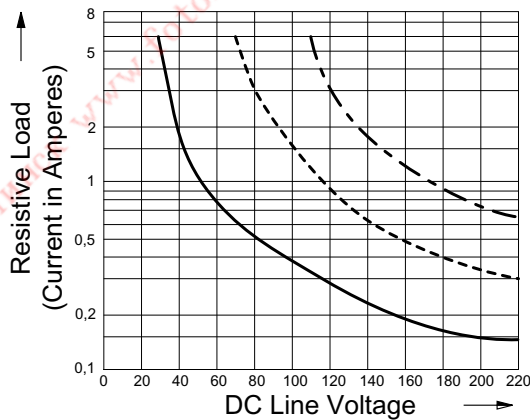

- Single contact
- - - - - 2 contacts in series
- · - · - 3 contacts in series

### Relay Diagrams

UF 2

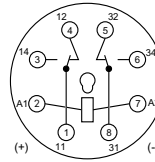

UF 3

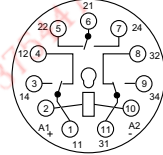

UB

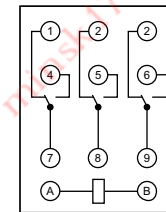

For 2 Pole UB relays omit the center pole in the diagram.

### Dimensions

UF

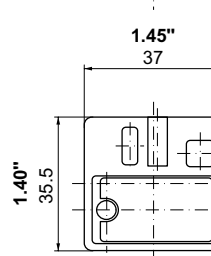
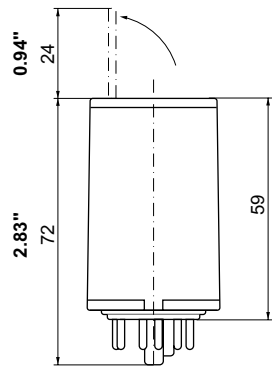

UB

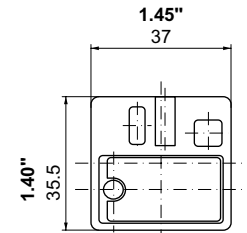
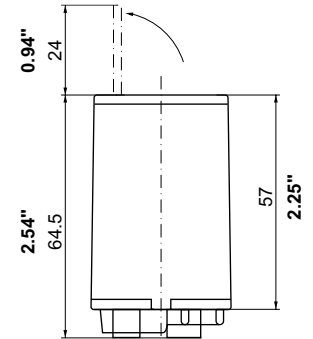

# Technical Specifications

## Quattro Relays™

Kuhnke Modular Relay Group

### Detailed Specifications 114 Relays

#### General Information

Number of contacts: 4 Pole  
Contact type: Double Throw (Form C)  
Contact material: Silver Nickel (AgNi)  
Max. Voltage: 250 VAC / 110 VDC  
Current ratings-  
    Minimum: 10 mA @ 5 Volts  
    Maximum: 10 A.@250V AC / 24V DC  
Weight: 1 oz. (33 grams)

#### Standards

UL File: E63473  
CSA: LR 47569  
VDE: According to DIN EN 60255-1-00/  
VDE 0435 part 201  
IEC: According to IEC 255-1-00  
CE: Low Voltage Directive

#### Performance Information

Pick-up time: 10 ms  
Drop out time: 10 ms  
Contact bounce time: 5 ms  
Mechanical Life: 20 million plus operations  
Electrical Life: See Charts  
Maximum Inrush Current: 20 A.  
Max. Switching Capacity: 144W DC / 2000 VA AC  
Operating Ambient Temp: -25°C to +60°C  
Vibration Resistance-  
    N/C contact: Greater than 2 g's  
    N/O contact: Greater than 10 g's  
Dielectric Strength-  
    Coil to Contact: 2000 VAC  
    Between Poles: 2000 VAC  
    Between open contacts: 1000 VAC

#### Coil Information

Coil Power Consumption-  
    DC: 1 W  
    AC: 0.98 VA 60Hz/ 1.2 VA 50 Hz  
Pull in Power DC: 0.42 W  
Coil Inrush Current AC: 1.5 x Coil Current  
Operating Range-  
    DC: 80 to 110% of rated Voltage  
    AC 60 / 50 Hz: 85 to 110% of rated Voltage

Voltage	Resistance (Ohms-Ω)	Coil Power Consumption mA		
		60 Hz	50 Hz	
AC	12	46.5	81	100
	24	177	41	50
	48	762	20	25
	120	4570	8.8	11
	230	19040	4.2	5.2
DC	12	143	84	
	24	576	42	
	48	2250	21	
	110	12100	9	

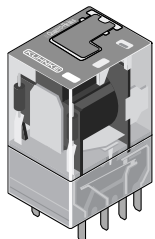

## Detailed Specifications 114 Relays

### Estimated Contact Life – AC Loads

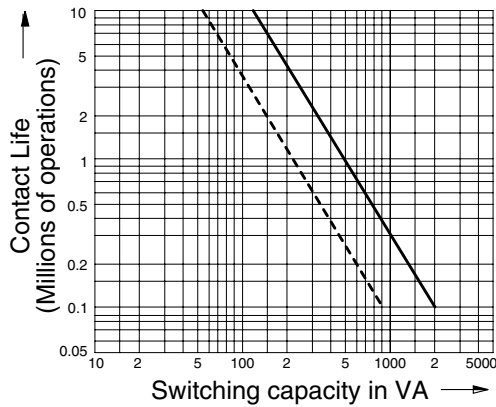

**Resistive Load**  
 **Inductive Load**  
 (Power Factor  $\cos \phi = 0.4$  to  $0.7$ )

The above chart is based on tests at 230 V AC. For lower voltages reduce contact life by the percentage difference in line voltage.  
 Example: For 500 VA @ 115 V, (standard contact, resistive load), the contact life is one million operations at 230V. ( $115V \div 230 = .5$  or 50%). Therefore the contact life at 115 V is estimated at 500K operations.

### DC Loads – Contact Capacity

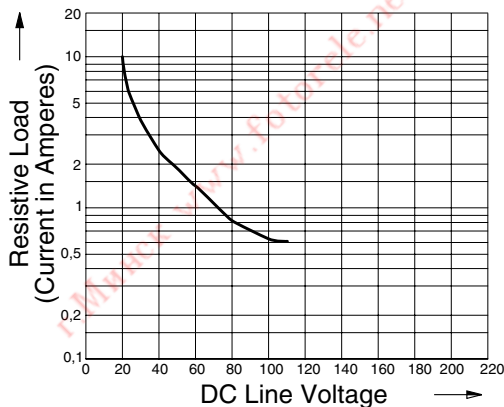

### Relay Diagram

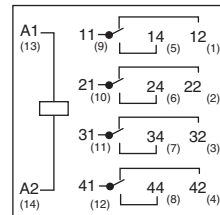

Relays equipped with DC surge suppressors are polarity dependent. Connect coil leads as noted.

Standard (cat. no. suffix F1)	(+) to A1
Optional (cat. no. suffix F)	(+) to A2

### Dimensions

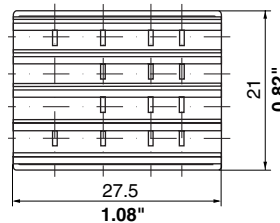
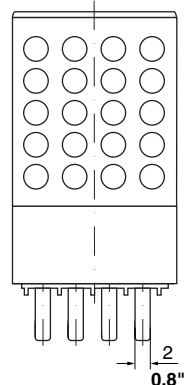
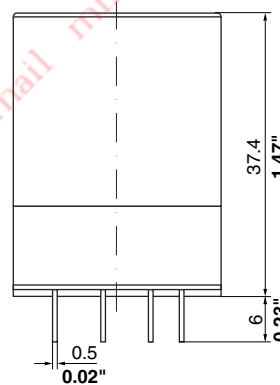

# Technical Specifications

## Miniatur Relays™

Kuhnke Modular Relay Group

### Detailed Specifications 111 Relays

#### General Information

Number of contacts: 2 or 4 Pole  
Contact type: Double Throw (Form C)  
Contact Material: Silver-Nickel  
Max. Voltage: 250 VAC  
Current ratings-  
Minimum: 50 mA @ 20 Volts  
Maximum: 5 Amperes  
Weight: .6 oz. (20 grams)

#### Standards

UL File: E63473  
CSA: LR 47569  
VDE: According to DIN EN 60255-1-00/  
VDE 0435 part 201  
IEC: According to IEC 255-1-00  
CE: Low Voltage Directive

#### Performance Information

Pick-up time: 10 ms  
Drop out time: 8 ms  
Contact bounce time: 3 ms  
Mechanical Life: 20 million plus operations  
Electrical Life: See Charts  
Maximum inrush current: 8 Amperes  
Max. switching capacity: 1250 VA  
Operating Ambient Temp: -25°C to +55°C  
Vibration Resistance-  
Dielectric Strength-  
Coil to Contact: 2500 VAC  
Between Poles: 2000 VAC  
Between open contacts: 1000 VAC

#### Coil Information

Coil Power Consumption-  
DC: 1 W  
AC: 1.6 VA  
Pull in Power DC: 0.6 W  
Coil Inrush Current AC: 1.5 x Coil Current  
Operating Range @ 20°C: 85 to 110% of rated Voltage

Voltage	Resistance (Ohms-Ω)	Coil Power Consumption mA		
		60 Hz	50 Hz	
AC	12	46.5	81	100
	24	176	55	65
	48	740	27	32
	115	4300	14	11
	230	17100	5.5	6.7
DC	12	160	75	
	24	520	46	
	48	2100	23	
	110	12100	9	

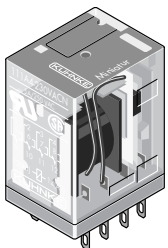

## Detailed Specifications 111 Relays

### Estimated Contact Life – AC Loads

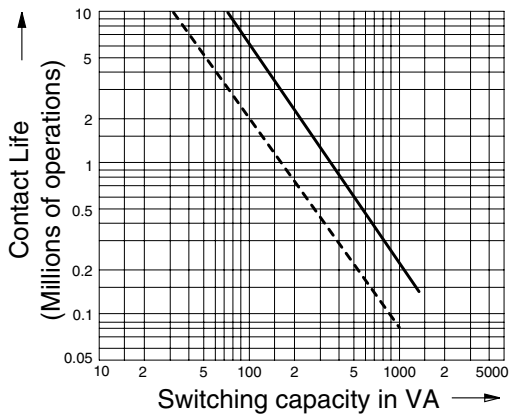

Resistive Load  
 Inductive Load  
 (Power Factor  $\cos \varphi = 0.4$  to  $0.7$ )

The above chart is based on tests at 230 V AC. For lower voltages reduce contact life by the percentage difference in line voltage.  
 Example: For 1000 VA @ 115 V, (standard contact, resistive load), the contact life is 200K operations at 230V. ( $115V \div 230 = .5$  or 50%). Therefore the contact life at 115 V is estimated at 100K operations.

### DC Loads – Contact Capacity

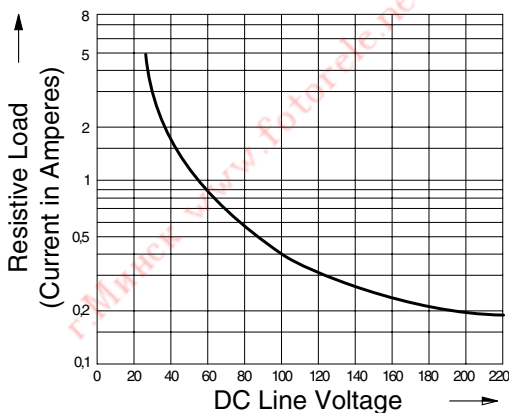

### Relay Diagrams

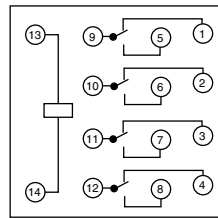

For 2 Pole relays omit the center 2 poles in the diagram.

### Dimensions

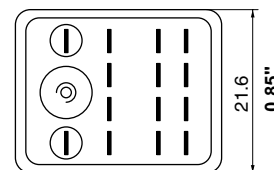
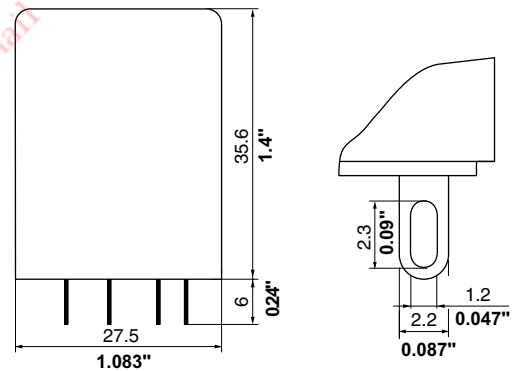



# Technical Specifications

## PCB Interface Relays

Kuhnke Modular Relay Group

### Detailed Specifications 107 Relays

#### General Information

	<b>107G1</b>	<b>107G2</b>	<b>107P1</b>
Number of contacts:	1	2	1
Maximum Voltage-			
AC:	250 V	250 V	400 V
DC:	150 V	150 V	150 V
Current ratings:			
Minimum @ 5 VDC:	100 mA	100 mA	100 mA
Maximum @ 240 VAC:	10 A	5 A	16 A
Maximum @ 24 VDC:	10 A	5 A	16 A
Contact type:	Double Throw (Form C)		
Contact Material:	Silver Cadmium Oxide		
Weight:	.5 oz. (18 grams)		

#### Standards

UL File:	E 41922
CSA:	LR 72763
VDE:	According to DIN EN 60255-1-00/ VDE 0435 part 201
IEC:	According to IEC 255-1-00
CE:	Low Voltage Directive

#### Coil Information

Coil Power Consumption-	
Standard DC:	.7 W
High Resistance Coil DC:	.52 W

Pull in Power-	
Standard DC:	.35 W
High Resistance Coil DC:	.26 W

Operating Range @ 20°C:	80 to 110% of rated Voltage
-------------------------	-----------------------------

#### Performance Information

	<b>107G1</b>	<b>107G2</b>	<b>107P1</b>
Pick-up time:	10 ms	10 ms	20 ms
Drop-out time:	5 ms	5 ms	10 ms
Contact bounce time:	6 ms	8 ms	6 ms
Max. Inrush Current:	10 A	5 A	16 A
Max. Switching Cap.-			
Resistive DC:	240 W	120 W	480 W
Resistive AC:	2400VA	1200VA	4000VA
Mechanical Life:	20 million plus operations		
Electrical Life:	See charts		
Oper. Ambient Temp:	-5° C to +65°C		
Vibration Resistance:	Greater than 6 g's		
Dielectric Strength-			
Coil to Contact:	5000 V AC		
Between Poles:	2500 V AC		
Between open contacts:	1000 V AC		

	Voltage DC	Resistance (Ohms-Ω)	Coil Power Consumption mA
Std.	6	50	120
	12	200	60
	24	820	30
	48	3330	14
High Res. coil	6	68	88
	12	270	44
	24	1100	22
	48	4400	11

#### Wiring Diagrams (viewed from top)

107G1

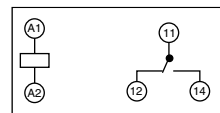

107G2

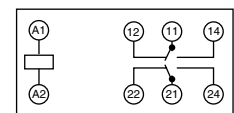

107P1

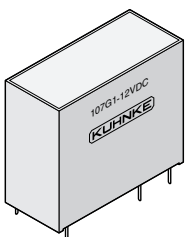
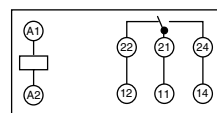

### Detailed Specifications 107 Relays

#### Estimated Contact Life – AC Loads

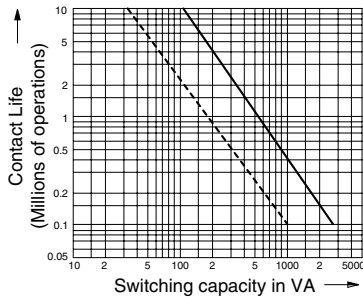

**107G1**

— Resistive Load    - - - Inductive Load

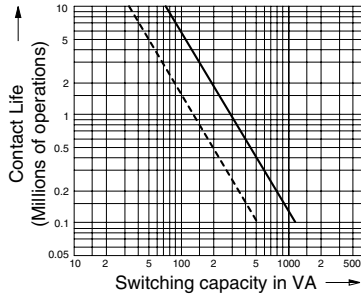

**107G2**

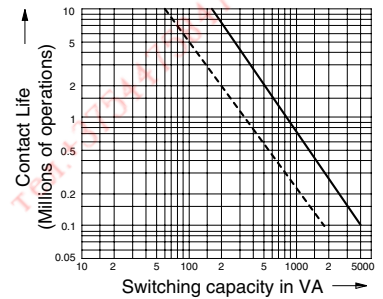

**107P1**

The above charts are based on tests at 230V AC. For lower voltages, reduce contact life by the percentage difference in the line voltage. Example: For 1200 VA @ 115V (107G2- resistive load chart), the contact life is 2 million operations @230 V. ( $115 \div 230 = .5$  or 50%). Therefore the contact life at 115V is estimated at 1 million operations.

#### DC Loads – Contact Capacity

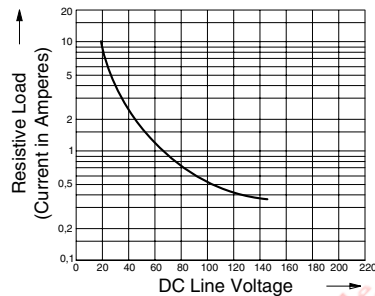

**107G1**

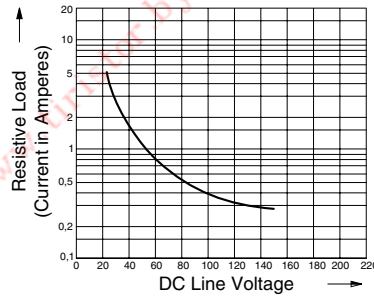

**107G2**

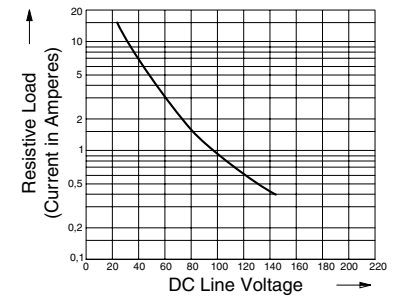

**107P1**

#### Dimensions

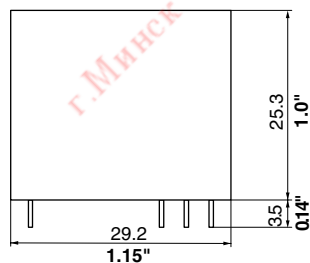

**107G1**

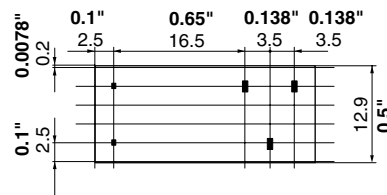

**107G2, 107P1**

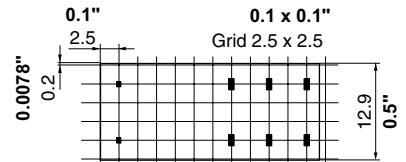

(Relay bottom views)  
For PCB mounting - hole diameter for coil = .039" (1mm)  
hole diameter for contacts = .051" (1.3mm)

# Technical Specifications

## PCB Interface Relays

Kuhnke Modular Relay Group

### Detailed Specifications 171 Relays

#### General Information

	<b>171G1</b>	<b>171G2</b>	<b>171P1</b>
Number of contacts:	1	2	1
Maximum Voltage-			
AC:	250 V	250 V	400 V
DC:	150 V	150 V	150 V
Current ratings:			
Minimum @ 5 VDC:	10 mA	10 mA	10 mA
Maximum @ 240 VAC:	12 A	10 A	16 A
Maximum @ 24 VDC:	6 A	4 A	10 A
Contact type:	Double Throw (Form C)		
Contact Material:	Silver Nickel Alloy		
Weight:	.4 oz. (14 grams)		

#### Performance Information

	<b>171G1</b>	<b>171G2</b>	<b>171P1</b>
Pick-up time:	10 ms	10 ms	10 ms
Drop-out time	8 ms	8 ms	8 ms
Contact bounce time	2 ms	2 ms	2 ms
Max. Inrush Current:	15 A	10 A	20 A
Max. Switching Cap.-			
Resistive DC:	192 W	100 W	240 W
Resistive AC:	2000VA	1000VA	3000VA
Mechanical Life:	20 million plus operations		
Electrical Life:	See charts		
Oper. Ambient Temp:	-5° C to +75° C		
Vibration Resistance:	Greater than 4 g's		
Dielectric Strength-			
Coil to Contact:	5000 V AC		
Between Poles:	2500 V AC		
Between open contacts:	1000 V AC		

#### Standards

UL File:	E 41922
CSA:	LR 47569
VDE:	According to DIN EN 60255-1-00/ VDE 0435 part 201
IEC:	According to IEC 255-1-00
CE:	Low Voltage Directive

#### Coil Information

Coil Power Consumption-	
DC:	.4 W
AC:	.7 VA 50 Hz/.6 VA 60 Hz
Pull in Power DC:	.2 W
Coil Inrush Current AC:	1.5 x Coil current

Operating Range @ 20°C: 80 to 110% of rated Voltage

Voltage	Resistance (Ohms-Ω)	Coil Power Consumption mA	
		60 Hz	50 Hz
AC	24	24	32
	115	5.1	6.6
	230	2.5	3.3
DC	12	33	
	24	17	

#### Wiring Diagrams (viewed from top)

171G1

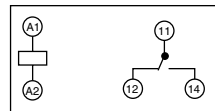

171G2

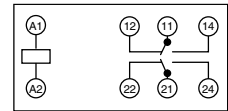

171P1

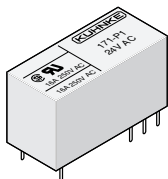
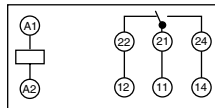

### Detailed Specifications 171 Relays

#### Estimated Contact Life – AC Loads

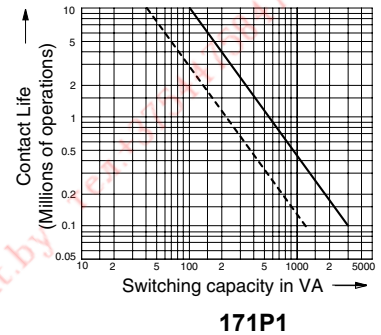
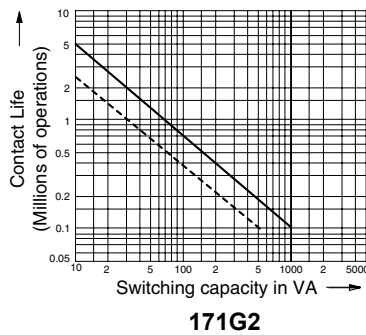
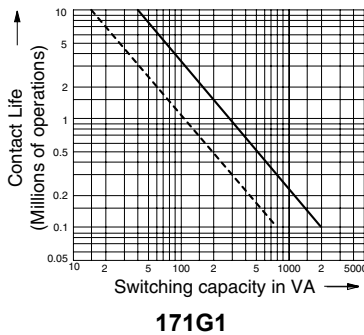

— Resistive Load    - - - Inductive Load

The above charts are based on tests at 230V AC. For lower voltages, reduce contact life by the percentage difference in the line voltage. Example: For 100 VA @ 115V (171G2- resistive load chart), the contact life is 700 thousand operations @230 V. ( $115 \div 230 = .5$  or 50%). Therefore the contact life at 115V is estimated at 350 thousand operations.

#### DC Loads – Contact Capacity

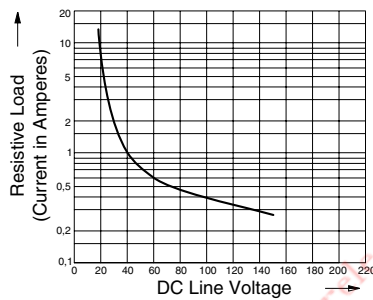

#### Dimensions

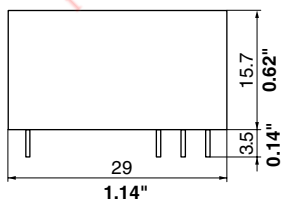

**171G1**

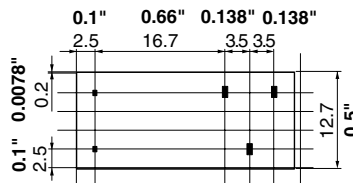

**171G2, 171P1**

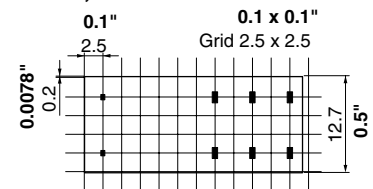

(Relay bottom views)

For PCB mounting - hole diameter = .051" (1.3mm).

## Other Relay Product Families:

**105** Relay/Contactors with mechanically guided contacts for small motor applications. For socket or printed circuit board mounting.



**130** Octal socket timing relays available in several versions.



**C** Electromechanical and solid state rail mounted interface relays.



**E** Mechanically Interlocked Relays, dual coils with walking beam construction, 6 Amp. 250V. for socket or PCB mounting.

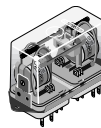

**F** Impulse latching Relays. Pulses of 50ms or more latches or unlatches relay contacts. For socket or PCB mounting, 6 Amp. 250V. rating.

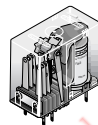

**I** Industrial relays up to 8 contacts (6A, 400V). Versions include mechanically guided contacts for high shock applications, DC blow out magnets and high capacity switching.



**MF** For current monitoring applications or for switching higher voltages (400V). Used in marine or airport navigation systems.



**P** Open type single pole 50 Amp. power relay available with several contact materials and DC blowout magnets. For surface mounting.

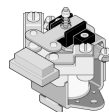

**PCB** Family of Printed Circuit Board relays rated 5 to 15 Amperes, up to 400V AC and available in several contact configurations.



**PZ** Process relays for converting analog and digital signals.



**U500**  
**U1500** Monitoring relays including voltage, current, three phase out of step, and motor protection.



## Relays by Catalog type

105A, 105G  
107  
109\*, 110\*  
111A, 111B, 111H, 111G  
114A  
117\*, 119\*  
130  
135A\*  
138\*, 139\*  
150\*  
152  
171, 173, 174, 175, 176, 178  
C, CB\*, CD, C-T\*  
EB, EG  
F1570, FE17\*  
FA, FG  
FR\*  
HA, HF, HG  
I1540  
IA, IC, IG, IR, IX, IY  
IA2, IK2 Timers\*  
ID\*, IE\*  
IF-D\*  
IH100  
KC\*, KH\*, KB\*, KG\*  
LV\*, LH\*  
MA, MG\*  
MF  
NA\*, NF\*  
PZ  
PA, PR  
RB\*, RE, RG\*  
RH100\*  
RS-xxxx Special Relays- see below  
SB\*  
SD5\*  
U15, UD15  
U2Tr-K\*  
U5  
UA  
UB, UF  
UD1\*, UG1\*, UW\*  
UT\*, UH\*, UG\*  
Zxxx- Relay Accessories

\* - Obsolete

## Special Relays

Kuhnke manufactures relays for special applications. These relays can be a modification of any standard type relay listed above. Special relays have an identification mark – RS (for Relay-Special) followed by a 4-digit file number (example: RS-7131). Special relays are non-stock and made to order.



KUHNKE ...  
IMPULSES FOR  
AUTOMATION.



Kuhnke Automation Inc.  
P.O. Box 1369  
Wayne, NJ 07474-1369

Phone: 973-633-0690  
Fax: 973-633-7230  
email: kuhnkeusa1@aol.com  
Internet: www.kuhnkeusa.com

г. Минск www.fotorele.net www.tiristor.by email minsk17@tut.by тел.+375447584780