

реле промежуточное силовое купить продажа Беларусьг.Минск
www.fotorele.net www.tiristor.by email_minsk17@tut.by
тел.+375447584780

DB ELECTRO

Présente / Presents:

NINGBO HUAGUAN ELECTRONICS CO.,LTD.





28×21.5×35

3C:28×31.5×36

4C:28×41.5×36



03001003500



R50016343



E158859

JQX-13F

Features

- Small size, light weight, heavy reverse power.
- Optional mounting ways.
- Firm structure, strong anti-shock & anti vibration.
- Suitable for automatic control, telecommunication equipment, household electrical appliances and machinery electrical facilities.

Ordering Information

JQX-13F 2C a DC12V 1 L

1 2 3 4 5 6

1 Part number: JQX-13F

2 Contact arrangement: 1A:1A; 2A:2A; 1B:1B; 2B:2B;
1C:1C; 2C:2C; 3C:3C; 4C:4C

3 Terminal: a:inserting type; b:PCB type

4 Coil rated voltage(V): AC:6,12,24,36,48,110,120,220,240
DC:6,12,24,36,48,110,220

5 Cover: 1:1Mode; 2:2 Mode

6 Coil transient suppression: L:with LED;
D:with diode;
LD:with LED & diode
NIL:standard

Contact Data

Contact Material	AgCdO AgSnO ₂					
Contact Arrangement			1A (SPSTNO) 1B (SPSTNC) 1C (SPDT(B-M))	2A (DPSTNO) 2B (DPSTNC) 2C (DPDT(B-M))	3C (3PDT(B-M))	4C (4PDT(B-M))
Contact Rating (resistive)	Contact Current		15A 20A		10A	10A
	Contact voltage		277VAC,28VDC			
	Coil Power	DC	0.9W	0.9W	1.4W	1.5W
		AC	1.2VA	1.2VA	2VA	2.5VA
Max. Switching Voltage	30VDC 300VAC		Max. Switching Current:20A			
Max. Resistance or Voltage drop	≤50mΩ		item 3.12 of IEC255-7			
Operational life	Electrical	10 ⁵		item 3.30 of IEC255-7		
	Mechanical	2 × 10 ⁷		item 3.31 of IEC255-7		

Coil Parameter (DC)

Dash numbers	Coil voltage V		Coil resistance Ω ± 10%	Pick up voltage V(max) (80%of rated voltage)	Release voltage V(min) (10%of rated voltage)	Coil power W	Operate Time ms	Release Time ms
	Rated	Max.						
006-900	6	6.6	40	4.8	0.6	0.9	<25	<25
012-900	12	13.2	160	9.6	1.2			
024-900	24	26.4	640/650	19.2	2.4			
036-900	36	39.6	1440	28.8	3.6			
048-900	48	52.8	2560	38.4	4.8			
110-900	110	121	13444	88.0	11.0			
220-900	220	242	53778	176	22.0			
012-1400	12	13.2	107	9.6	1.2	1.4	<25	<25
024-1400	24	26.4	410	19.2	2.4			
036-1400	36	39.6	926	28.8	3.6			
048-1400	48	52.8	1700	38.4	4.8			
110-1400	110	121	8500	88.0	11.0			
220-1400	220	242	34571	176	22.0			
012-1500	12	13.2	100	9.6	1.2			
024-1500	24	26.4	350	19.2	2.4			
036-1500	36	39.6	865	28.8	3.6			
048-1500	48	52.8	1600	38.4	4.8			
110-1500	110	121	6900	88.0	11.0			
220-1500	220	242	32267	176	22.0			

CAUTION-N: 1.The use of any coil voltage less than the rated coil voltage will compromise the operation of the relay.
2.Pickup and release voltage are for test purposes only and are not to be used as design criteria.

Coil Parameter (AC)

Dash numbers	Coil voltage V		Coil resistance $\Omega \pm 10\%$	Rated current mA	Pick up voltage V(max) (80%of rated voltage)	Release voltage V(min) (30%of rated voltage)	Coil power VA
	Rated	Max.					
006AC-1200	6	6.6	11.5	183.0	4.8	1.8	1.2
012AC-1200	12	13.2	46	91.0	9.6	3.6	
024AC-1200	24	26.4	184	46.0	19.2	7.2	
036AC-1200	36	39.6	320	33.0	28.8	10.8	
048AC-1200	48	52.8	735	24.0	38.4	14.4	
110AC-1200	110	121	3900	11.0	88.0	33.0	
120AC-1200	120	132	4550	9.8	96.0	36.0	
220AC-1200	220	242	14400	4.2	176	66.0	
240AC-1200	240	312	15210	5.5	192	72.0	
012AC-2000	12	13.2	24	167	9.6	3.6	2.0
024AC-2000	24	26.4	100	83	19.2	7.2	
036AC-2000	36	39.6	230	56	28.8	10.8	
048AC-2000	48	52.8	410	42	38.4	14.4	
110AC-2000	110	121	2300	18	88.0	33.0	
220AC-2000	220	242	8600	9.1	176	66.0	
240AC-2000	240	312	12100	6.2	192	72.0	
012AC-2500	12	13.2	20	208	9.6	3.6	2.5
024AC-2500	24	26.4	78	104	19.2	7.2	
036AC-2500	36	39.6	180	69	28.8	10.8	
048AC-2500	48	52.8	350	52.1	38.4	14.4	
110AC-2500	110	121	1600	22.7	88.0	33.0	
220AC-2500	220	242	6700	11.4	176	66.0	
240AC-2500	240	312	9120	9.8	192	72.0	

CAUTION: 1.The use of any coil voltage less than the rated coil voltage will compromise the operation of the relay.
2.Pickup and release voltage are for test purposes only and are not to be used as design criteria.

Operation condition

Insulation Resistance ¹⁾	1000M Ω min (at 500VDC)	Item 7 of IEC255-5
Dielectric Strength ¹⁾		
Between contacts	50Hz 1000V	Item 6 of IEC255-5
Between contact and coil	50Hz 1500V	Item 6 of IEC255-5
Shock resistance	100m/s ² 11ms	IEC68-2-27 Test Ea
Vibration resistance	10~55Hz double amplitude 1.5mm	IEC68-2-6 Test Fc
Terminals strength	8N 4N(PC type)	IEC68-2-21 Test Ua2
Solderability	235 $^{\circ}$ C \pm 2 $^{\circ}$ C 3 \pm 0.5s	IEC68-2-20 Test Ta method 1
Ambient Temperature	-40~70 $^{\circ}$ C; -25~70 $^{\circ}$ C(3C,4C)	
Relative Humidity	85% (at 30 $^{\circ}$ C)	IEC68-2-3Test Ca
Mass	37g(1C,2C);50g(3C);70g(4C)	

Note: 1). When testing, coil terminals should be connected , if LED is installed in relay .

Qualification inspection:

Perform the qualification test as specified in the table IV of IEC255-19-1 and minimum sample size 24.

Safety approvals

Safety approval	UL&CUR	TuV	CQC
Load	10A/277VAC 12A/250VAC,28VDC ½HP 125VAC	10A/277VAC,28VDC	10A/220VAC

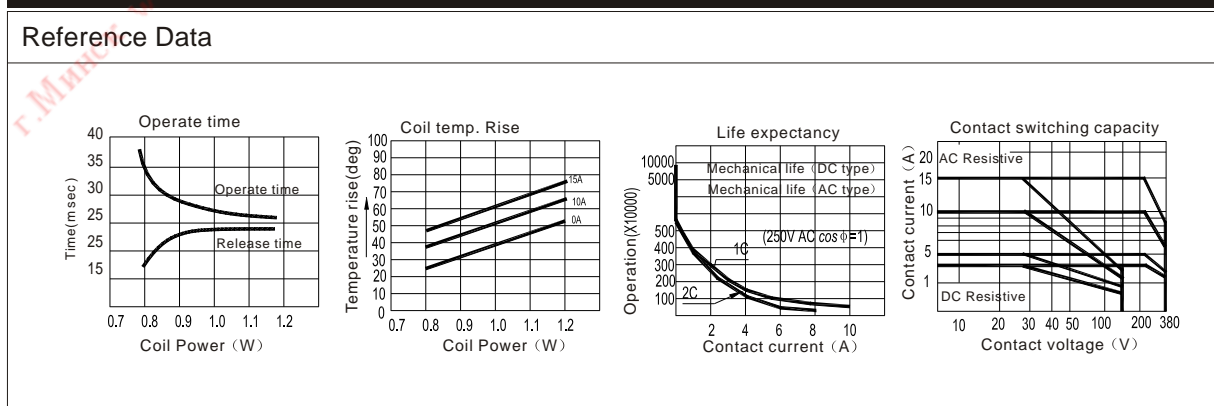
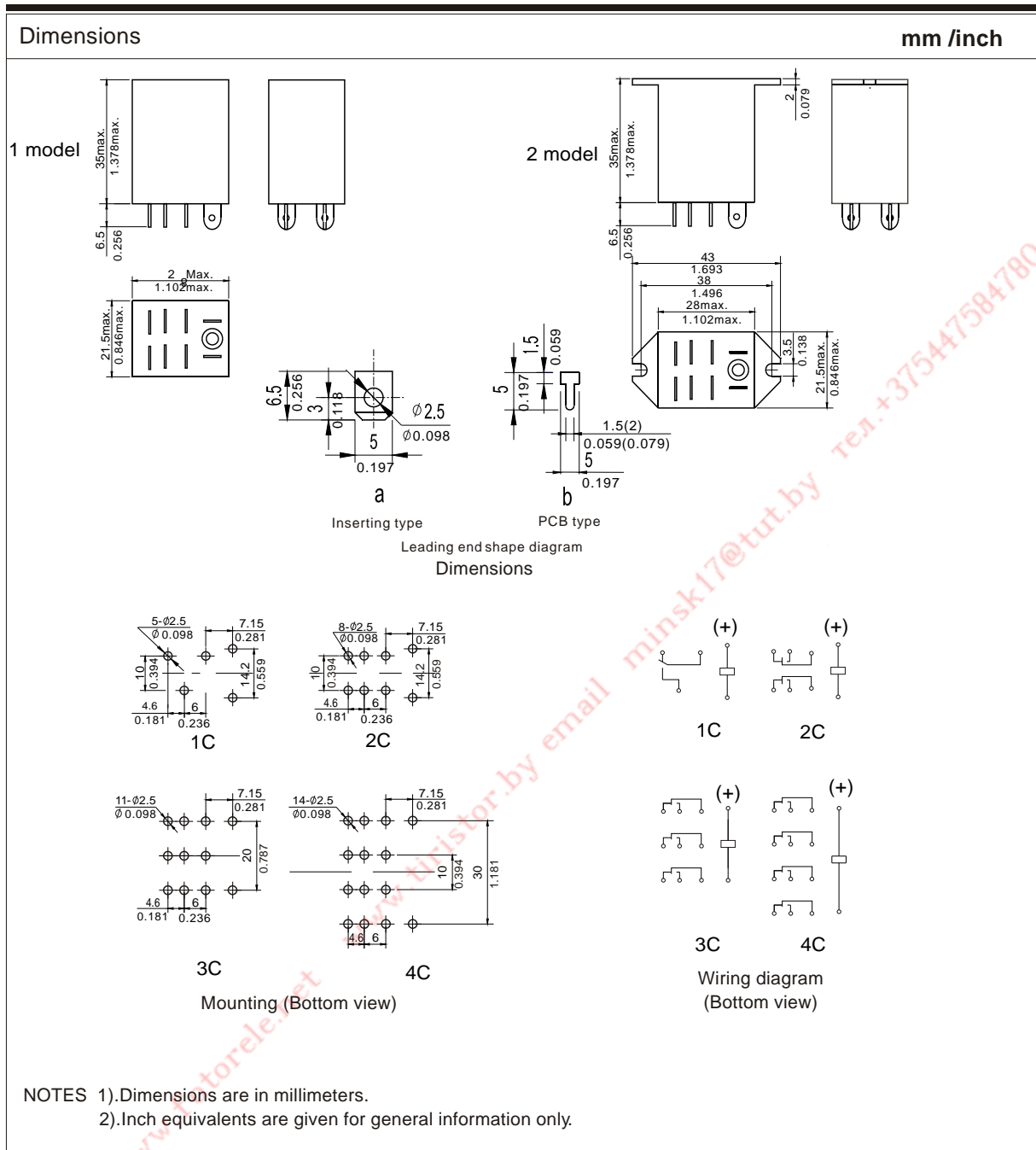



MCJQX-13F-KF2C-XXXX



MCJQX-13F-KF4C-XXXX

Features

- Small size
- High switching power
- High sensitivity

Specifications

Contact	Contact Form		2 Change	4 Change
	Rated Load	Resistive (AC-1)		10A/250V AC 30V DC
Motor (AC-15)			1/3HP, 120V AC 1/2HP, 240V AC	1/3HP, 240V AC 1/6HP, 240V AC
Operating Power (Resistive)			2500VA 300W	1250VA 150W
Contact Resistance (Initial)			≤50mΩ	
Material			Ag alloy	
Electrical Life			≥ 10 ⁵ Cycles (1800 Ops/h)	
Mechanical Life			≥ 10 ⁷ Cycles (18000 Ops/h)	
Operate Voltage (at 25°C)			DC: ≤75% Rated Voltage, AC: ≤80% Rated Voltage	
Release Voltage (at 25°C)			DC: ≥10% Rated Voltage, AC: ≥30% Rated Voltage	
Max. Allowed voltage (at 25°C)			110% Rated Voltage	
Insulation Resistance			≥500MΩ (500V DC)	
Coil Power Consumption	DC (W)		0.9	
	AC (VA)		1.2	
Operate Time			≤20ms	
Release Time			≤20ms	
Dielectric Strength	Between Contacts		1,000V AC/1 min (Leakage Current 1mA)	
	Between Contacts (different pole)		1,000V AC/1 min (Leakage Current 1mA)	
	Between contact and coil		2,000V AC/1 min (Leakage Current 1mA)	
Ambient Temperature			-55°C to +70°C	
Humidity			35% RH to 85% RH	
Atmospheric Pressure			86KPa to 106KPa	
Shock Resistance			10G (Half a wave of pulses of sine: 11ms)	
Vibration Resistance			10~55Hz Dual amplitude: 1mm	
Install Model			Plug-in Terminals/PCB Terminal	
Weight			35g	

Coil Type (25°C)

V DC Rated Voltage	24	-	-
Ω ($\pm 10\%$) Coil Resistance	630	-	-
V AC Rated Voltage	24	110	230
Ω ($\pm 10\%$) Coil Resistance	160	3750	15000

Dimension Bottom View

MCJQX-13F-KF2C-XXXX

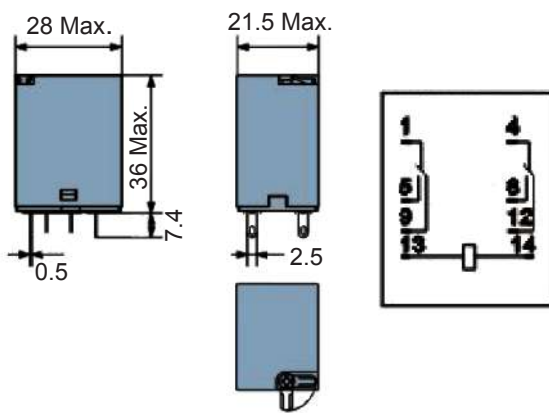

MCJQX-13F-KF4C-XXXX

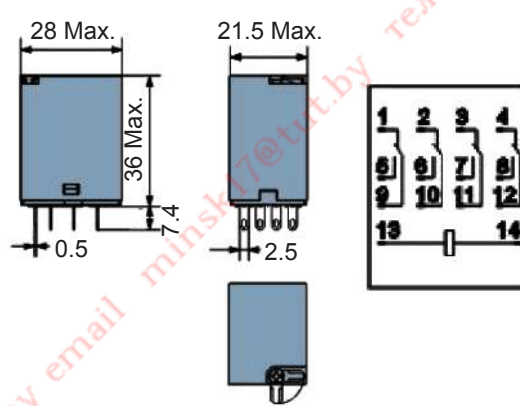

Dimensions : Millimetres

Part Number Table

Description	Part Number
Relay, 2C, 10A, 24V DC with Lock Test Button	MCJQX-13F-KF2C-24VDC
Relay, 2C, 10A, 24V DC with Lock Test Button	MCJQX-13F-KF2C-24VAC
Relay, 2C, 10A, 110V AC, with Lock Test Button	MCJQX-13F-KF2C-110VAC
Relay, 2C, 10A, 230V AC, with Lock Test Button	MCJQX-13F-KF2C-230VAC
Relay, 4C, 5A, 24V DC, with Lock Test Button	MCJQX-13F-KF4C-24VDC
Relay, 4C, 5A, 24V AC, with Lock Test Button	MCJQX-13F-KF4C-24VAC
Relay, 4C, 5A, 110V AC, with Lock Test Button	MCJQX-13F-KF4C-110VAC
Relay, 4C, 5A, 230V AC, with Lock Test Button	MCJQX-13F-KF4C-230VAC

Important Notice : This data sheet and its contents (the "Information") belong to the members of the Premier Farnell group of companies (the "Group") or are licensed to it. No licence is granted for the use of it other than for information purposes in connection with the products to which it relates. No licence of any intellectual property rights is granted. The Information is subject to change without notice and replaces all data sheets previously supplied. The Information supplied is believed to be accurate but the Group assumes no responsibility for its accuracy or completeness, any error in or omission from it or for any use made of it. Users of this data sheet should check for themselves the Information and the suitability of the products for their purpose and not make any assumptions based on information included or omitted. Liability for loss or damage resulting from any reliance on the Information or use of it (including liability resulting from negligence or where the Group was aware of the possibility of such loss or damage arising) is excluded. This will not operate to limit or restrict the Group's liability for death or personal injury resulting from its negligence. Multicomp is the registered trademark of the Group. © Premier Farnell Limited 2016.

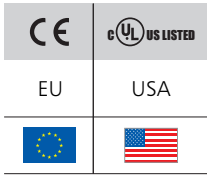

JQX-13F Miniature Power Relay

1. Features

- 1.1 10A switching capacity
- 1.2 Choice of PCB and plug-in types
- 1.3 Various sockets available
- 1.4 With indicator to be selected
- 1.5 Wide range of coil ratings
- 1.6 Certificate: CE, UL

2. Ordering information

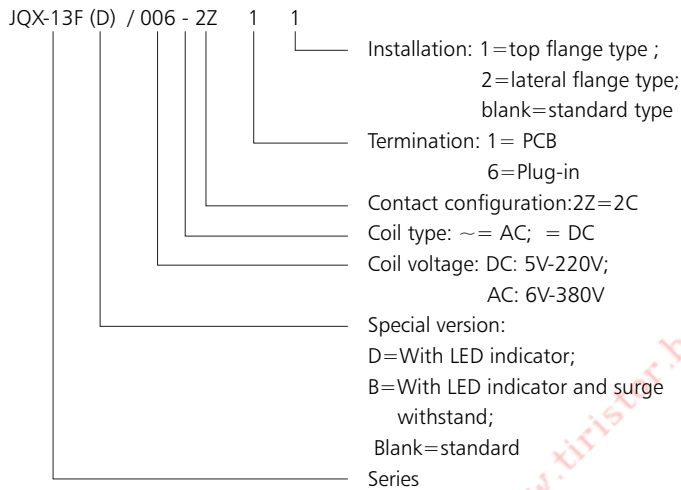

3. Contact specification

Contact Arrangement		2C
Initial contact resistance	m Ω	100
Contact material		Silver alloy
Rated load(resistive)		10A/220VAC,10A/28VDC
Max. switching voltage	VAC	250
	VDC	125
Max. switching current	A	10
Max. swithcing capacity	VA	2200
	W	280
Electrical endurance	Cycles($\times 10^3$)	100
Machanical endurance	Cycles($\times 10^6$)	10

4. Coil specification

AC					DC				
Rated voltage	Holding voltage	Must drop-out voltage	Operating range	Power consumption	Rated voltage	Holding voltage	Must drop-out voltage	Operating range	Power consumption
6	80%Un	30%Un	(80%-110%)Un	1.2VA	5	75%Un	10%Un	(75%-110%)Un	0.9W
12					6				
24					12				
36					24				
48					36				
110					48				
127					110				
220					125				
380					220				

5. Characteristics

Insulation resistance(at 500VDC)	mΩ	100
Dielectric strength	Between coil & contacts	1500VAC for 1 min
	Between open contacts	1000VAC for 1 min
Operation time	ms	≤25
Release time	ms	≤25
Shock resistance	m/s ²	100
Vibration		10 ~ 55Hz, 1mm double amplitude
Humidity		90% RH at +40℃
Ambient temperature range	℃	-30 ~ +60
Termination		PCB, plug-in
Dimension	mm	27.5×21.5×35.5

6. Overall mounting dimensions (mm)

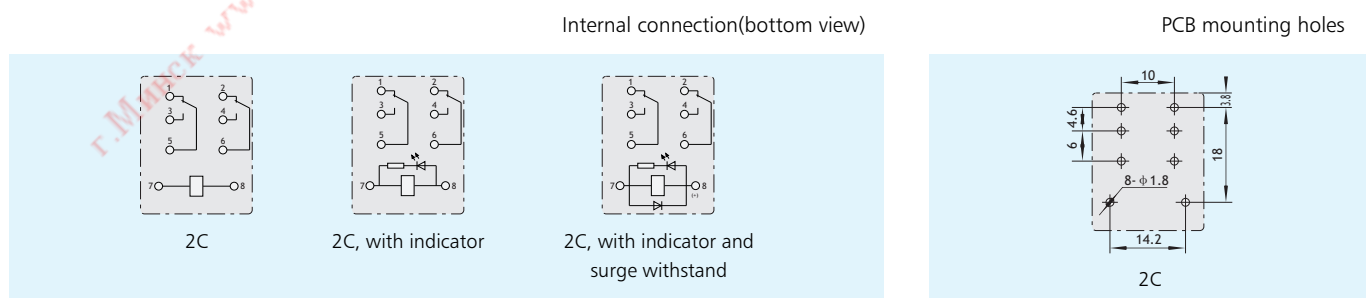

Dimensions

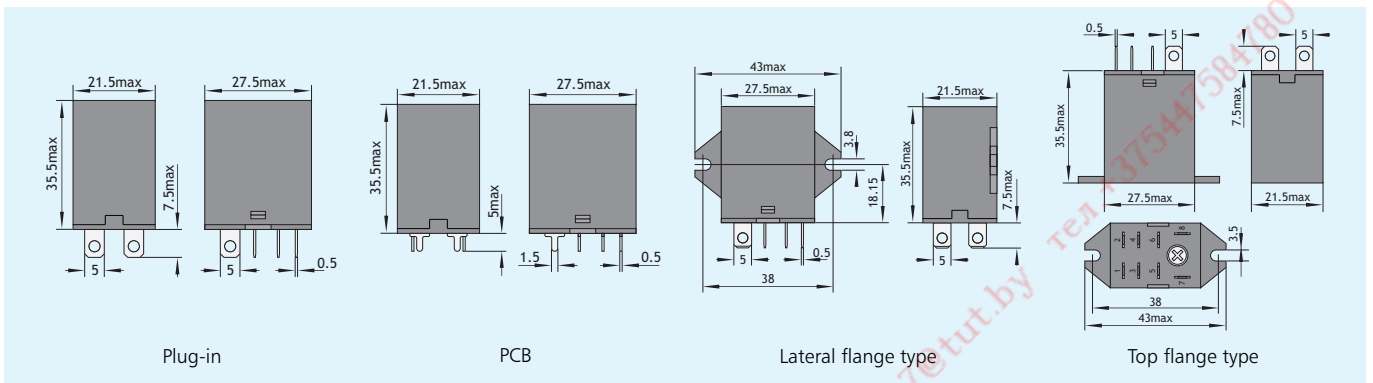

7. Socket

Dimensions: 72×30×31 (mm)

CZT08A-01

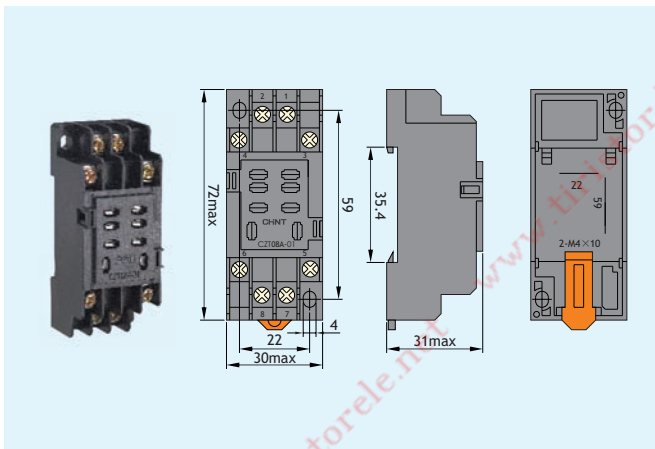

Dimensions: 72×30×31 (mm)

CZT08A-02

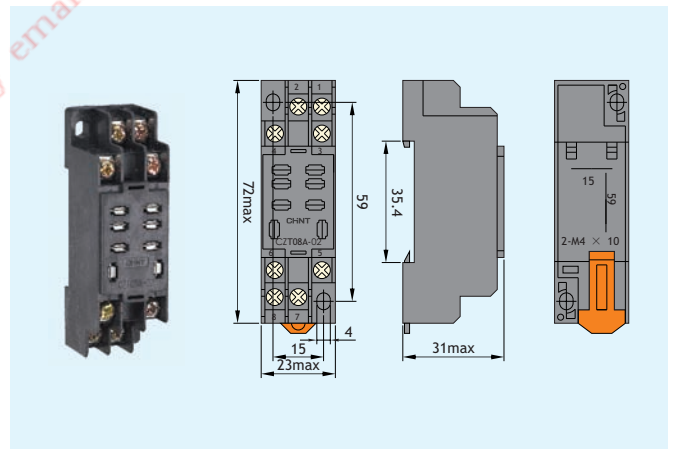

Dimensions: 68×30×28 (mm)

CZT08B-01

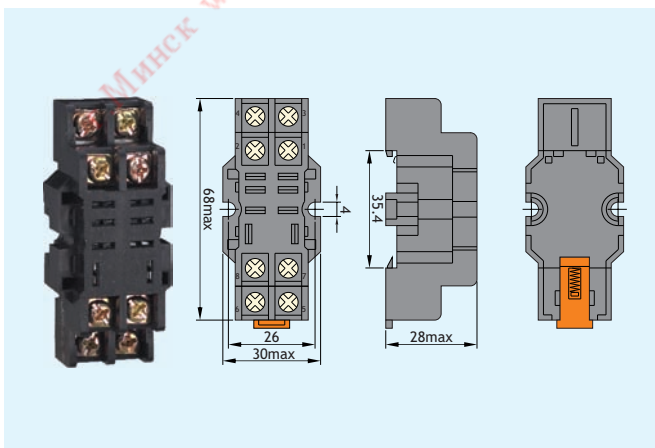

Dimensions: 68×30×28 (mm)

CZT08B-01E
With finger proof

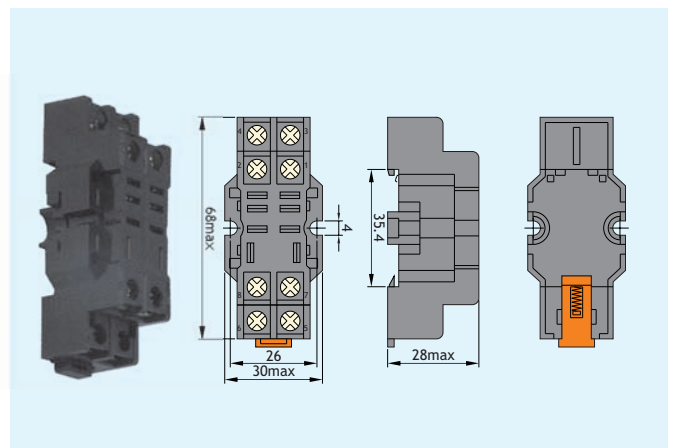



JQX-13F

03001003500 10002045756
R50126378 c us E158859

1C,2C:28×21.5×35.5 3C:28×31.5×36 4C:28×41.5×36

Features	
<ul style="list-style-type: none"> Small size, light weight, heavy reverse power. Optional mounting ways. Firm structure, strong anti-shock & anti vibration. Suitable for automatic control, telecommunication equipment, household electrical appliances and machinery electrical facilities. 	

Ordering Information	
JQX-13F 2C a DC12V 1 L	
1 Part number: JQX-13F	5 Cover: 1:1Mode; 2:2 Mode
2 Contact arrangement: 1A:1A; 2A:2A; 3A:3A; 1B:1B; 2B:2B; 3B:3B; 1C:1C; 2C:2C; 3C:3C; 4A:4A; 4B:4B; 4C:4C	6 Coil transient suppression: L:with LED; D:with diode; LD:with LED & diode; NIL:standard
3 Terminal: a:inserting type; b:PCB type	
4 Coil rated voltage(V): AC:6,12,24,36,48,110,120,220,240	
	DC:6,12,24,36,48,110,220

Contact Data	
Contact Material	AgCdO AgSnO ₂
Contact Arrangement	1A(1H)(SPSTNO) 2A(2H)(DPSTNO) 3A(3H)(SPSTNO) 4A(3H)(SPSTNO) 1B(1D)(SPSTNC) 2B(2D)(DPSTNC) 3B(3D)(SPSTNC) 4B(3D)(SPSTNC) 1C(1Z)(SPDT(B-M)) 2C(2Z)(DPDT(B-M)) 3C(3Z)(3PDT(B-M)) 4C(4Z)(4PDT(B-M))
Contact Rating	Resistive 15A, 20A/277VAC, 28VDC 10A/277VAC, 12A/250VAC, 28VDC
	Motor load 1/3 HP 120VAC 240VAC 1/3 HP 120VAC 240VAC 1/3HP 125VAC 1/2 HP 125VAC
Coil power	DC 0.9W 0.9W 1.4W 1.5W
	AC 1.2VA 1.2VA 2VA 2.5VA
Max. Switching Voltage	30VDC 300VAC
Max. Switching Power	560W 5540VA Max. Switching Current:20A
Max. Resistance or Voltage drop	≤50mΩ Item 4.12 of IEC 61810-7
Operational life	Electrical 10 ⁵ Item 4.30 of IEC 61810-7
	Mechanical 2 × 10 ⁷ Item 4.31 of IEC 61810-7

Dash numbers	Coil voltage V		Coil resistance Ω ±10%	Pick up voltage V(max) (80%of rated voltage)	Release voltage V(min) (10%of rated voltage)	Coil power W	Operate Time ms	Release Time ms
	Rated	Max.						
006-900	6	6.6	40	4.8	0.6	0.9	<25	<25
012-900	12	13.2	160	9.6	1.2			
024-900	24	26.4	640/650	19.2	2.4			
036-900	36	39.6	1440	28.8	3.6			
048-900	48	52.8	2600	38.4	4.8			
110-900	110	121	11000	88.0	11.0			
220-900	220	242	53778	176	22.0			
012-1400	12	13.2	107	9.6	1.2	1.4	<25	<25
024-1400	24	26.4	410	19.2	2.4			
036-1400	36	39.6	926	28.8	3.6			
048-1400	48	52.8	1700	38.4	4.8			
110-1400	110	121	8500	88.0	11.0			
220-1400	220	242	34571	176	22.0			
012-1500	12	13.2	100	9.6	1.2			
024-1500	24	26.4	350	19.2	2.4			
036-1500	36	39.6	865	28.8	3.6			
048-1500	48	52.8	1600	38.4	4.8			
110-1500	110	121	6900	88.0	11.0			
220-1500	220	242	32267	176	22.0			

CAUTION: 1.The use of any coil voltage less than the rated coil voltage will compromise the operation of the relay.
2.Pickup and release voltage are for test purposes only and are not to be used as design criteria.

Coil Parameter (AC)

Dash numbers	Coil voltage V		Coil resistance Ω ±10%	Rated current mA	Pick up voltage V(max) (80%of rated voltage)	Release voltage V(min) (30%of rated voltage)	Coil power VA
	Rated	Max.					
006AC-1200	6	6.6	11.5	183.0	4.8	1.8	1.2
012AC-1200	12	13.2	46	91.0	9.6	3.6	
024AC-1200	24	26.4	184	46.0	19.2	7.2	
036AC-1200	36	39.6	320	33.0	28.8	10.8	
048AC-1200	48	52.8	735	24.0	38.4	14.4	
110AC-1200	110	121	3900	11.0	88.0	33.0	
120AC-1200	120	132	4550	9.8	96.0	36.0	
220AC-1200	220	242	14400	5.5	176	66.0	
240AC-1200	240	312	19000	4.2	192	72.0	
012AC-2000	12	13.2	24	167	9.6	3.6	
024AC-2000	24	26.4	100	83	19.2	7.2	
036AC-2000	36	39.6	230	56	28.8	10.8	
048AC-2000	48	52.8	410	42	38.4	14.4	
110AC-2000	110	121	2300	18	88.0	33.0	
220AC-2000	220	242	8600	9.1	176	66.0	
240AC-2000	240	312	12100	6.2	192	72.0	
012AC-2500	12	13.2	20	208	9.6	3.6	2.5
024AC-2500	24	26.4	78	104	19.2	7.2	
036AC-2500	36	39.6	180	69	28.8	10.8	
048AC-2500	48	52.8	350	52.1	38.4	14.4	
110AC-2500	110	121	1600	22.7	88.0	33.0	
220AC-2500	220	242	6700	11.4	176	66.0	
240AC-2500	240	312	9120	9.8	192	72.0	

CAUTION: 1.The use of any coil voltage less than the rated coil voltage will compromise the operation of the relay.
2.Pickup and release voltage are for test purposes only and are not to be used as design criteria.

Operation condition

Insulation Resistance ¹⁾	1000MΩ min (at 500VDC)	Item 7 of IEC 60255-5
Dielectric Strength ¹⁾	Between contacts 50Hz 1000V Between contact and coil 50Hz 1500V	Item 6 of IEC 60255-5 Item 6 of IEC 60255-5
Shock resistance	100m/s ² 11ms	IEC 68-2-27 Test Ea
Vibration resistance	10Hz~55Hz double amplitude 1.5mm	IEC 68-2-6 Test Fc
Terminals strength	8N 4N(PC type)	IEC 68-2-21 Test Ua2
Solderability	235℃ ± 2℃ 3s ± 0.5s	IEC 68-2-20 Test Ta method 1
Ambient Temperature	-40℃~70℃; -25℃~70℃(3C,4C)	
Relative Humidity	85% (at 30℃)	IEC 68-2-3 Test Ca
Mass	37g(1C,2C);50g(3C);70g(4C)	

Note: 1). When testing, coil terminals should be connected, if LED is installed in relay.

Safety approvals

Safety approval	UL&CUR	TiV	CQC
Load	1A,1B,1C:20A/277VAC,28VDC 1/3 HP120VAC,240VAC 2A,2B,2C,3A,3B,3C,4A,4B,4C: 10A/277VAC,12A/250VAC,28VDC 1/2 HP 125VAC 2A,2B,2C: 1/3 HP120VAC,240VAC	10A/277VAC,28VDC	10A/220VAC 10A/277VAC

Dimensions

mm /inch

1 model

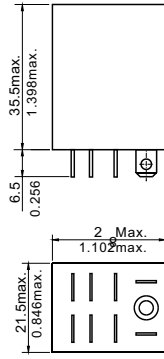

2 model

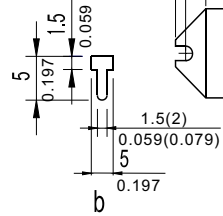
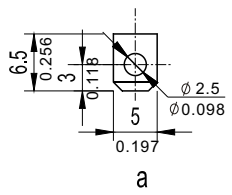
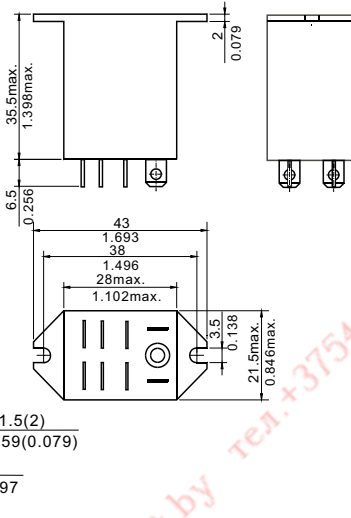

Inserting type

PCB type

Leading end shape diagram
Dimensions

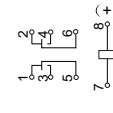
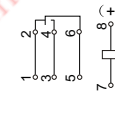
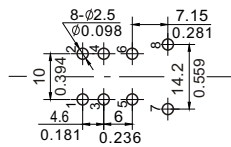
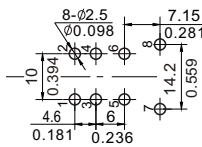

1C

2C

1C

2C

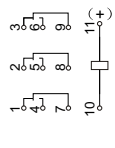
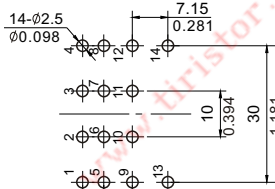
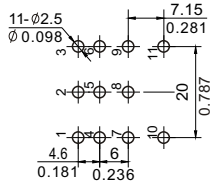

3C

4C

3C

4C

Mounting (Bottom view)

Wiring diagram
(Bottom view)

NOTES 1).Dimensions are in millimeters.
2).Inch equivalents are given for general information only.

Reference Data

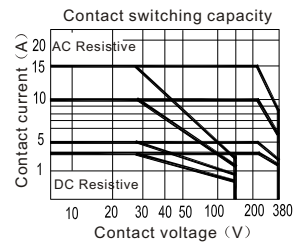
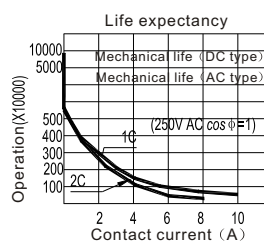
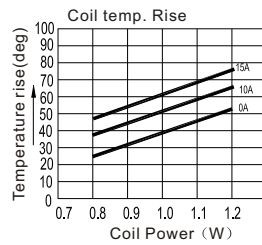
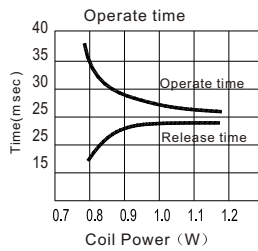

JQX-13F

MINIATURE INTERMEDIATE POWER RELAY



File No.:E133481



File No.:R9857445



File No.:CQC02001001941



Features

- * 15A switching capabilities
- * 1&2 pole configurations
- * 1.5KV dielectric between coil to contacts
- * Various terminals available
- * Various sockets available
- * Conform to the CE low voltage directive

CONTACT DATA

Contact Arrangement	1C	2C
Initial Contact Resistance Max.	50mΩ(at 1A 24VDC)	
Contact Material	Silver Alloy	
Contact Rating (Res. Load)	1C: 15A 220VAC/28VDC 2C: 10A 220VAC/28VDC	
Max. switching voltage	250VAC/28VDC	
Max. switching current	15A	10A
Max. switching power	3750VAC/450W	2200VAC/280W
Mechanical life	2 x 10 ⁷ OPS	
Electrical life	1 x 10 ⁵ OPS	

COIL

Coil power	DC:0.9W AC:1.2VA
------------	------------------

COIL DATA

Nominal Voltage VDC	Pick-up Voltage VDC	Drop-out Voltage VDC	Coil Resistance Ω
5	4.0	0.5	27.5 ± 10%
6	4.8	0.6	40 ± 10%
12	9.6	1.2	160 ± 10%
24	19.2	2.4	650 ± 10%
48	38.4	4.8	2600 ± 15%
110	88.0	11.0	11000 ± 15%

CHARACTERISTICS

Initial Insulation Resistance	500MΩ, 500VAC	
Dielectric Strength	Between coil and Contacts	1500VAC 1min.
	Between open contacts	1000VAC 1min.
	Between contact sets	1500VAC 1min.
Operate time (at nomi. Volt.)	25ms	
Release time (at nomi. Volt.)	25ms	
Shock Resistance	Functional	100 m/s ²
	Destructive	1000 m/s ²
Vibration Resistance	1 mm, 10 to 55Hz	
Humidity	98%RH, +40°C	
Ambient temperature	-40°C to +70°C	
Termination	PCB & Plug-in	
Unit weight	37g	
Construction	Dust cover	

Nominal Voltage VAC	Pick-up Voltage VAC	Drop-out Voltage VAC	Coil Resistance Ω
6	4.80	1.8	11.5 ± 10%
12	9.60	3.6	46 ± 10%
24	19.2	7.2	184 ± 10%
48	38.4	14.4	735 ± 10%
120	96.0	36.0	4550 ± 15%
220/240	176.0	66.0	14400 ± 15%

SAFETY APPROVAL RATINGS

UL	1C:	15A 250VAC/30VDC
	2C:	10A 250VAC/30VDC
TÜV		2C: 10A 250VAC/30VDC



HONGFA RELAY
ISO9001 *ISO/TS16949 *ISO14001 CERTIFIED

VERSION: EN02-20040601

ORDERING INFORMATION

Type	JQX-13F / A 012 2Z 1 D 016
Coil Source	A: AC Nil: DC
Coil voltage	AC: 5 to 110VDC DC: 6 to 240VAC
Contact arrangement	1Z: 1 Form C 2Z: 2 Form C
Mounting Termination	1: Type 1 (Socket) 2: Type 2 (PCB) 3/4/5: Type 3/4/5 (Flange-Mounting) See the following
LED	D: With LED Nil: Without LED
Customer special request code	(For example: (016) pin number 1,2,3,4,5,6,7,8)

OUTLINE DIMENSIONS, WIRING DIAGRAM AND PC BOARD LAYOUT

JQX-13F/ -1Z1

Outline Dimensions

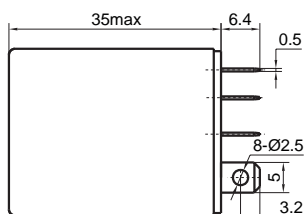

Wiring Diagram

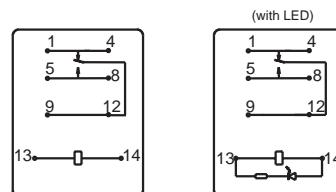

(Bottom view)

JQX-13F/ -2Z2

Outline Dimensions

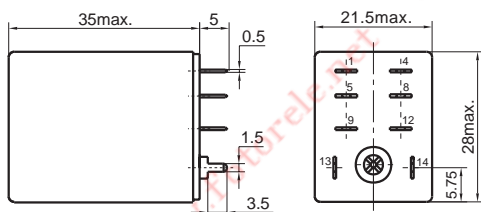

PCB layout

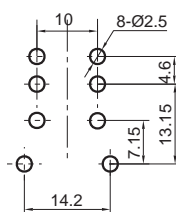

Wiring Diagram

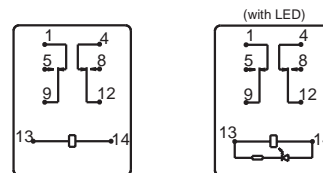

(Bottom view)

JQX-13F/ -2Z4

Outline Dimensions

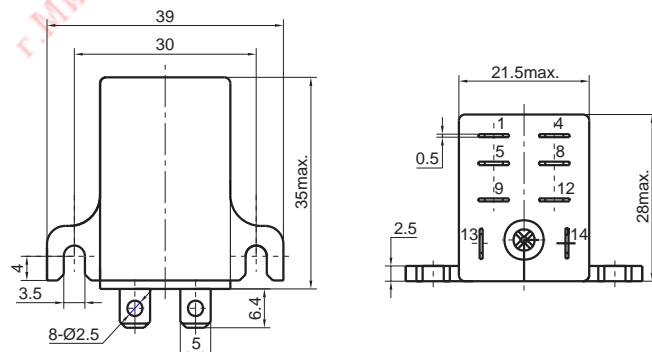

PCB layout

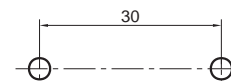

JQX-13F/ -2Z1

Outline Dimensions

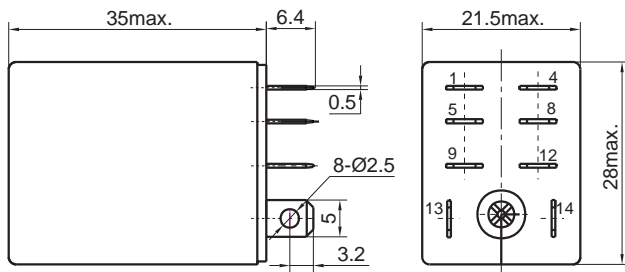

Wiring Diagram

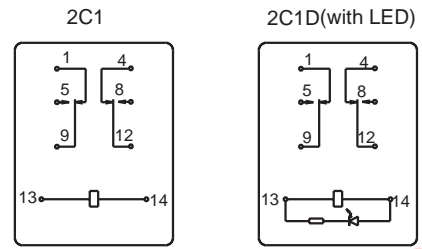

(Bottom view)

JQX-13F/ -2Z3

Outline Dimensions

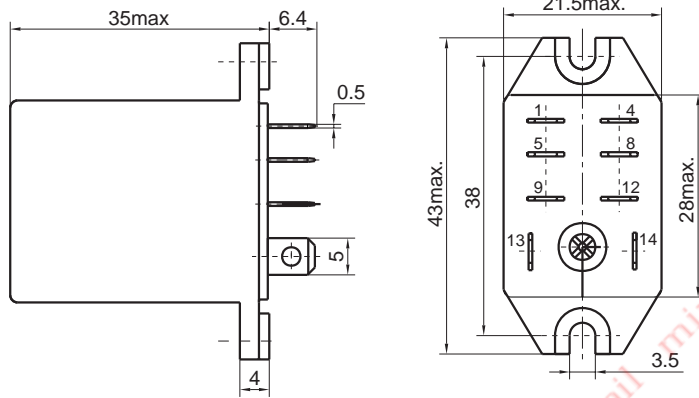

PCB layout

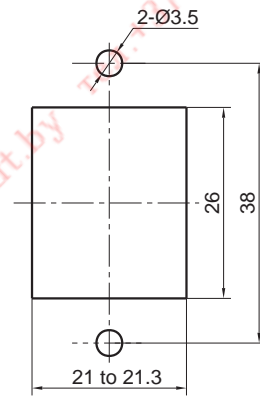

JQX-13F/ -2Z5

Outline Dimensions

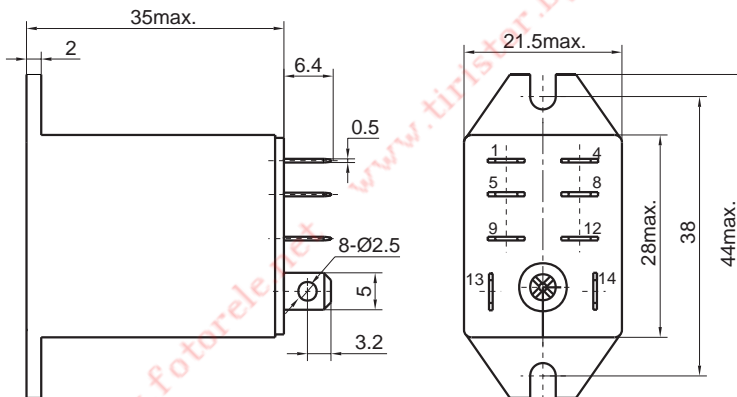

PCB layout

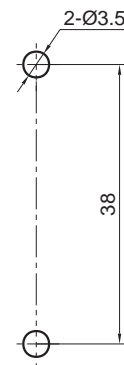

CHARACTERISTICS CURVE

MAXIMUM SWITCHING POWER(1C)

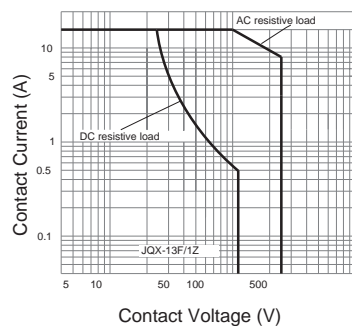

MAXIMUM SWITCHING POWER(2C)

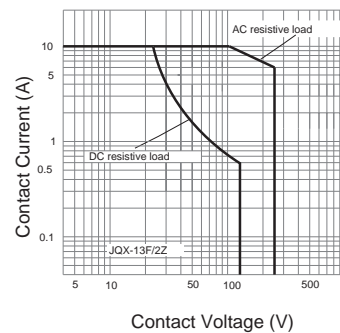



HJQ-13F

SPECIFICATION

FILE NUMBER: P-08KD101A

DATE: 2001/11/02

■ Features

15A transfer contacts

Au-clad contact available



■ CONTACT DATA

Contact Form	2C	1C
Contact Material	AgCdO	AgCdO
Contact Ratings	10A 240VAC/30VDC	16A240VAC/30VDC
Max Switching Voltage	250VAC/30VDC	
Max Switching Current	12A	20A
Max Switching Power	3000VA/360W	4000VA/480 W
Contact Resistance	100m Ω Max	at 6VDC 1A
Life Expectancy Electrical	100,000	Operations(at30Operations/minute)
Machanical	10,000,000	Operations

■ GENERAL DATA

Insulation Resistance	100M Ω Min at 500VDC	
Dielectric Strength Between Open Contacts	1000VAC(for one minute)	
Between Contacts and coil	1500VAC(for one minute)	
Operate Time	25ms	
Release Time	25ms	
Temperature Range	-40°C to+70 °C	
Shock Resistance	Operating Extremes	20G
	Damage Limits	100G
Vibration Resistance	10-55Hz,1.5mm	
Humidity	40-85%	
Weight	Approx 35g	
Safety Standard	CSA:203664	

■ COIL DATA(2Z)

Nominal Voltage		Coil Resistance at 20±10%(Ω)		Max Operate Voltage		Min Release Voltage		Max Applicable Voltage	
5-110VDC	6-240VAC	VDC	VAC	VDC	VAC	VDC	VAC	VDC	VAC
		0.9W	1.2VA						
5	6	28	11.5	3.75	4.8	0.5	1.8	6.5	7.8
6	12	40	46	4.5	9.6	0.6	3.6	7.8	15.6
12	24	160	184	9	19.2	1.2	7.2	15.6	31.2
24	48	640	735	18	38.4	2.4	14.4	31.2	62.4
48	120	2560	4550±15%	36	96	4.8	36	62.4	156
110	220/240	13445	14400±15%	82.5	220	11	39.6	143	286/312

■ ORDERING CODE

HJQ-13F--12VDC--2Z(P)----F---D

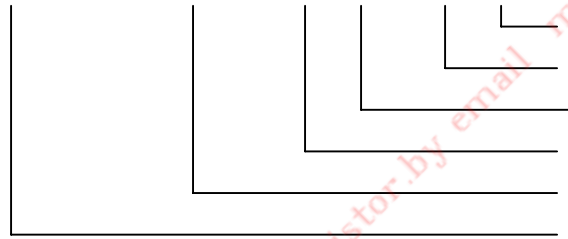

- With LED
- With Flange for 38mm pitch hole
- P: PCB Type Nil: B Type
- 1Z form 1C 2Z Form 2C
- Coil Nominal Voltage
- Relay Model

www.fotorele.net www.tinistor.by email: minsk17@tut.by тел: 27344118

OVERALL AND MOUNTING DIMENSIONS

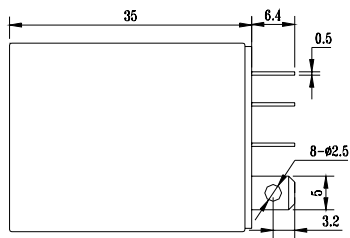

Dimensions

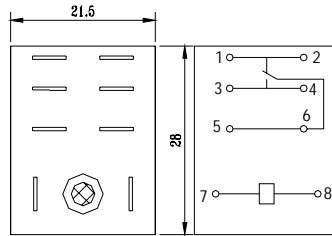

Terminal arrangement/
Internal connections
(Bottom view)

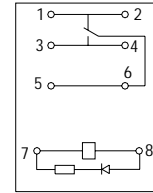

1ZD

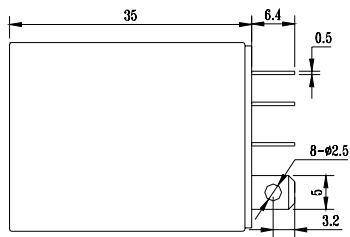

Dimensions

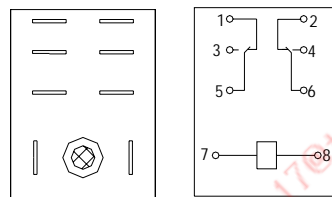

Terminal arrangement/
Internal connections
(Bottom view)

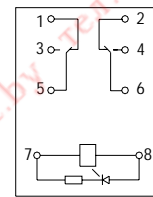

2ZD

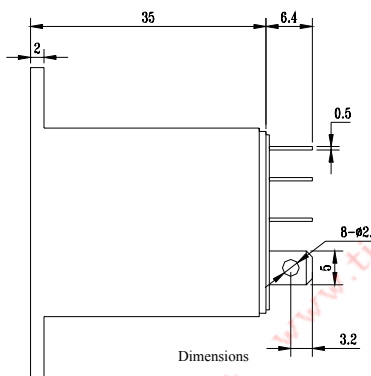

Dimensions

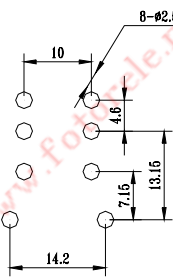
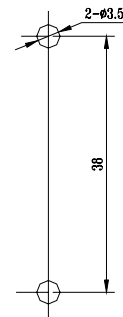
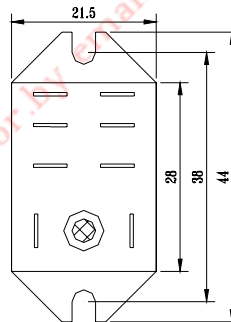

PCB Mounting



B Type

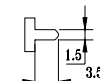

P Type

Реле ssr-1, Минск Т.80447584780

www.fotorele.net www.tiristor.by радиодетали, электронные компоненты

email minsk17@tut.by tel.+375 29 758 47 80 МТС

Реле, твердотельное, Crydom , модуль, каталог, описание, технические, характеристики, datasheet, параметры, маркировка, габариты, фото,

даташит, solid state relay, аналог, замена, **SSR-1, SSR-2, SSR-3,**



Реле твердотельные однофазные SSR-1, SSR-2, SSR-3

**Реле, твёрдотельное купить,
продажа, в наличии,
Минск, Беларусь**

**купить, продажа, радиодетали, электронные
компоненты**

в Минске , Беларусь

[как купить см. здесь >>>](#)

Реле, Finder, твердотельное, промежуточное, силовое купить в Минске tel. +375447584780
www.fotorele.net www.tiristor.by радиодетали, электронные компоненты
email minsk17@tut.by tel.+375 29 758 47 80 МТС

каталог, описание, технические, характеристики, datasheet, параметры, маркировка, габариты, фото



КОМПОНЕНТ	ОПИСАНИЕ
jqx-102f-a-z-20-b-dc12v-0.9	
jqx-102f-a-z-20-b-dc24v-0.9	
jqx-102f-a-z-20-b-dc48v-0.9	
jqx-102f-a-z-20-b-dc5v-0.9	
jqx-102f-a-z-20-dc12v-0.9	
jqx-102f-a-z-20-dc24v-0.9	
jqx-102f-a-z-20-dc48v-0.9	
jqx-102f-a-z-20-dc5v-0.9	
jqx-13f-1c-a-ac110v-1	
jqx-13f-1c-a-ac110v-1-d	
jqx-13f-1c-a-ac110v-1-l	
jqx-13f-1c-a-ac110v-1-ld	
jqx-13f-1c-a-ac120v-1	
jqx-13f-1c-a-ac120v-1-d	
jqx-13f-1c-a-ac120v-1-l	
jqx-13f-1c-a-ac120v-1-ld	
jqx-13f-1c-a-ac12v-1	
jqx-13f-1c-a-ac12v-1-d	
jqx-13f-1c-a-ac12v-1-l	
jqx-13f-1c-a-ac12v-1-ld	
jqx-13f-1c-a-ac220v-1	
jqx-13f-1c-a-ac220v-1-d	
jqx-13f-1c-a-ac220v-1-l	
jqx-13f-1c-a-ac220v-1-ld	
jqx-13f-1c-a-ac240v-1	
jqx-13f-1c-a-ac240v-1-d	

jqx-13f-1c-a-ac240v-1-l
jqx-13f-1c-a-ac240v-1-ld
jqx-13f-1c-a-ac24v-1
jqx-13f-1c-a-ac24v-1-d
jqx-13f-1c-a-ac24v-1-l
jqx-13f-1c-a-ac24v-1-ld
jqx-13f-1c-a-ac36v-1
jqx-13f-1c-a-ac36v-1-d
jqx-13f-1c-a-ac36v-1-l
jqx-13f-1c-a-ac36v-1-ld
jqx-13f-1c-a-ac48v-1
jqx-13f-1c-a-ac48v-1-d
jqx-13f-1c-a-ac48v-1-l
jqx-13f-1c-a-ac48v-1-ld
jqx-13f-1c-a-ac6v-1
jqx-13f-1c-a-ac6v-1-d
jqx-13f-1c-a-ac6v-1-l
jqx-13f-1c-a-ac6v-1-ld
jqx-13f-1c-a-dc110v-1
jqx-13f-1c-a-dc110v-1-d
jqx-13f-1c-a-dc110v-1-l
jqx-13f-1c-a-dc110v-1-ld
jqx-13f-1c-a-dc12v-1
jqx-13f-1c-a-dc12v-1-d
jqx-13f-1c-a-dc12v-1-l
jqx-13f-1c-a-dc12v-1-ld
jqx-13f-1c-a-dc220v-1
jqx-13f-1c-a-dc220v-1-d

jqx-13f-1c-a-dc220v-1-l
jqx-13f-1c-a-dc220v-1-ld
jqx-13f-1c-a-dc24v-1
jqx-13f-1c-a-dc24v-1-d
jqx-13f-1c-a-dc24v-1-l
jqx-13f-1c-a-dc24v-1-ld
jqx-13f-1c-a-dc36v-1
jqx-13f-1c-a-dc36v-1-d
jqx-13f-1c-a-dc36v-1-l
jqx-13f-1c-a-dc36v-1-ld
jqx-13f-1c-a-dc48v-1
jqx-13f-1c-a-dc48v-1-d
jqx-13f-1c-a-dc48v-1-l
jqx-13f-1c-a-dc48v-1-ld
jqx-13f-1c-a-dc6v-1
jqx-13f-1c-a-dc6v-1-d
jqx-13f-1c-a-dc6v-1-l
jqx-13f-1c-a-dc6v-1-ld
jqx-13f-2c-a-ac110v-1
jqx-13f-2c-a-ac110v-1-d
jqx-13f-2c-a-ac110v-1-l
jqx-13f-2c-a-ac110v-1-ld
jqx-13f-2c-a-ac120v-1
jqx-13f-2c-a-ac120v-1-d
jqx-13f-2c-a-ac120v-1-l
jqx-13f-2c-a-ac120v-1-ld
jqx-13f-2c-a-ac12v-1
jqx-13f-2c-a-ac12v-1-d

jqx-13f-2c-a-ac12v-1-l
jqx-13f-2c-a-ac12v-1-ld
jqx-13f-2c-a-ac220v-1
jqx-13f-2c-a-ac220v-1-d
jqx-13f-2c-a-ac220v-1-l
jqx-13f-2c-a-ac220v-1-ld
jqx-13f-2c-a-ac240v-1
jqx-13f-2c-a-ac240v-1-d
jqx-13f-2c-a-ac240v-1-l
jqx-13f-2c-a-ac240v-1-ld
jqx-13f-2c-a-ac24v-1
jqx-13f-2c-a-ac24v-1-d
jqx-13f-2c-a-ac24v-1-l
jqx-13f-2c-a-ac24v-1-ld
jqx-13f-2c-a-ac36v-1
jqx-13f-2c-a-ac36v-1-d
jqx-13f-2c-a-ac36v-1-l
jqx-13f-2c-a-ac36v-1-ld
jqx-13f-2c-a-ac48v-1
jqx-13f-2c-a-ac48v-1-d
jqx-13f-2c-a-ac48v-1-l
jqx-13f-2c-a-ac48v-1-ld
jqx-13f-2c-a-ac6v-1
jqx-13f-2c-a-ac6v-1-d
jqx-13f-2c-a-ac6v-1-l
jqx-13f-2c-a-ac6v-1-ld
jqx-13f-2c-a-dc110v-1
jqx-13f-2c-a-dc110v-1-d

jqx-13f-2c-a-dc110v-1-l
jqx-13f-2c-a-dc110v-1-ld
jqx-13f-2c-a-dc12v-1
jqx-13f-2c-a-dc12v-1-d
jqx-13f-2c-a-dc12v-1-l
jqx-13f-2c-a-dc12v-1-ld
jqx-13f-2c-a-dc220v-1
jqx-13f-2c-a-dc220v-1-d
jqx-13f-2c-a-dc220v-1-l
jqx-13f-2c-a-dc220v-1-ld
jqx-13f-2c-a-dc24v-1
jqx-13f-2c-a-dc24v-1-d
jqx-13f-2c-a-dc24v-1-l
jqx-13f-2c-a-dc24v-1-ld
jqx-13f-2c-a-dc36v-1
jqx-13f-2c-a-dc36v-1-d
jqx-13f-2c-a-dc36v-1-l
jqx-13f-2c-a-dc36v-1-ld
jqx-13f-2c-a-dc48v-1
jqx-13f-2c-a-dc48v-1-d
jqx-13f-2c-a-dc48v-1-l
jqx-13f-2c-a-dc48v-1-ld
jqx-13f-2c-a-dc6v-1
jqx-13f-2c-a-dc6v-1-d
jqx-13f-2c-a-dc6v-1-l
jqx-13f-2c-a-dc6v-1-ld
jqx-13f-3c-a-ac110v-1
jqx-13f-3c-a-ac110v-1-d

jqx-13f-3c-a-ac110v-1-l
jqx-13f-3c-a-ac110v-1-ld
jqx-13f-3c-a-ac120v-1
jqx-13f-3c-a-ac120v-1-d
jqx-13f-3c-a-ac120v-1-l
jqx-13f-3c-a-ac120v-1-ld
jqx-13f-3c-a-ac12v-1
jqx-13f-3c-a-ac12v-1-d
jqx-13f-3c-a-ac12v-1-l
jqx-13f-3c-a-ac12v-1-ld
jqx-13f-3c-a-ac220v-1
jqx-13f-3c-a-ac220v-1-d
jqx-13f-3c-a-ac220v-1-l
jqx-13f-3c-a-ac220v-1-ld
jqx-13f-3c-a-ac240v-1
jqx-13f-3c-a-ac240v-1-d
jqx-13f-3c-a-ac240v-1-l
jqx-13f-3c-a-ac240v-1-ld
jqx-13f-3c-a-ac24v-1
jqx-13f-3c-a-ac24v-1-d
jqx-13f-3c-a-ac24v-1-l
jqx-13f-3c-a-ac24v-1-ld
jqx-13f-3c-a-ac36v-1
jqx-13f-3c-a-ac36v-1-d
jqx-13f-3c-a-ac36v-1-l
jqx-13f-3c-a-ac36v-1-ld
jqx-13f-3c-a-ac48v-1
jqx-13f-3c-a-ac48v-1-d

jqx-13f-3c-a-ac48v-1-l
jqx-13f-3c-a-ac48v-1-ld
jqx-13f-3c-a-ac6v-1
jqx-13f-3c-a-ac6v-1-d
jqx-13f-3c-a-ac6v-1-l
jqx-13f-3c-a-ac6v-1-ld
jqx-13f-3c-a-dc110v-1
jqx-13f-3c-a-dc110v-1-d
jqx-13f-3c-a-dc110v-1-l
jqx-13f-3c-a-dc110v-1-ld
jqx-13f-3c-a-dc12v-1
jqx-13f-3c-a-dc12v-1-d
jqx-13f-3c-a-dc12v-1-l
jqx-13f-3c-a-dc12v-1-ld
jqx-13f-3c-a-dc220v-1
jqx-13f-3c-a-dc220v-1-d
jqx-13f-3c-a-dc220v-1-l
jqx-13f-3c-a-dc220v-1-ld
jqx-13f-3c-a-dc24v-1
jqx-13f-3c-a-dc24v-1-d
jqx-13f-3c-a-dc24v-1-l
jqx-13f-3c-a-dc24v-1-ld
jqx-13f-3c-a-dc36v-1
jqx-13f-3c-a-dc36v-1-d
jqx-13f-3c-a-dc36v-1-l
jqx-13f-3c-a-dc36v-1-ld
jqx-13f-3c-a-dc48v-1
jqx-13f-3c-a-dc48v-1-d

jqx-13f-3c-a-dc48v-1-l
jqx-13f-3c-a-dc48v-1-ld
jqx-13f-3c-a-dc6v-1
jqx-13f-3c-a-dc6v-1-d
jqx-13f-3c-a-dc6v-1-l
jqx-13f-3c-a-dc6v-1-ld
jqx-13f-4c-a-ac110v-1
jqx-13f-4c-a-ac110v-1-d
jqx-13f-4c-a-ac110v-1-l
jqx-13f-4c-a-ac110v-1-ld
jqx-13f-4c-a-ac120v-1
jqx-13f-4c-a-ac120v-1-d
jqx-13f-4c-a-ac120v-1-l
jqx-13f-4c-a-ac120v-1-ld
jqx-13f-4c-a-ac12v-1
jqx-13f-4c-a-ac12v-1-d
jqx-13f-4c-a-ac12v-1-l
jqx-13f-4c-a-ac12v-1-ld
jqx-13f-4c-a-ac220v-1
jqx-13f-4c-a-ac220v-1-d
jqx-13f-4c-a-ac220v-1-l
jqx-13f-4c-a-ac220v-1-ld
jqx-13f-4c-a-ac240v-1
jqx-13f-4c-a-ac240v-1-d
jqx-13f-4c-a-ac240v-1-l
jqx-13f-4c-a-ac240v-1-ld
jqx-13f-4c-a-ac24v-1
jqx-13f-4c-a-ac24v-1-d

jqx-13f-4c-a-ac24v-1-l
jqx-13f-4c-a-ac24v-1-ld
jqx-13f-4c-a-ac36v-1
jqx-13f-4c-a-ac36v-1-d
jqx-13f-4c-a-ac36v-1-l
jqx-13f-4c-a-ac36v-1-ld
jqx-13f-4c-a-ac48v-1
jqx-13f-4c-a-ac48v-1-d
jqx-13f-4c-a-ac48v-1-l
jqx-13f-4c-a-ac48v-1-ld
jqx-13f-4c-a-ac6v-1
jqx-13f-4c-a-ac6v-1-d
jqx-13f-4c-a-ac6v-1-l
jqx-13f-4c-a-ac6v-1-ld
jqx-13f-4c-a-dc110v-1
jqx-13f-4c-a-dc110v-1-d
jqx-13f-4c-a-dc110v-1-l
jqx-13f-4c-a-dc110v-1-ld
jqx-13f-4c-a-dc12v-1
jqx-13f-4c-a-dc12v-1-d
jqx-13f-4c-a-dc12v-1-l
jqx-13f-4c-a-dc12v-1-ld
jqx-13f-4c-a-dc220v-1
jqx-13f-4c-a-dc220v-1-d
jqx-13f-4c-a-dc220v-1-l
jqx-13f-4c-a-dc220v-1-ld
jqx-13f-4c-a-dc24v-1
jqx-13f-4c-a-dc24v-1-d

jqx-13f-4c-a-dc24v-1-l
jqx-13f-4c-a-dc24v-1-ld
jqx-13f-4c-a-dc36v-1
jqx-13f-4c-a-dc36v-1-d
jqx-13f-4c-a-dc36v-1-l
jqx-13f-4c-a-dc36v-1-ld
jqx-13f-4c-a-dc48v-1
jqx-13f-4c-a-dc48v-1-d
jqx-13f-4c-a-dc48v-1-l
jqx-13f-4c-a-dc48v-1-ld
jqx-13f-4c-a-dc6v-1
jqx-13f-4c-a-dc6v-1-d
jqx-13f-4c-a-dc6v-1-l
jqx-13f-4c-a-dc6v-1-ld
jqx-141ff-1c-s-5-dc12v-0.54-0.5
jqx-141ff-1c-s-5-dc24v-0.54-0.5
jqx-141ff-1c-s-5-dc3v-0.54-0.5
jqx-141ff-1c-s-5-dc48v-0.54-0.5
jqx-141ff-1c-s-5-dc5v-0.54-0.5
jqx-141ff-1c-s-5-dc9v-0.54-0.5
jqx-141ff-2c-z-5-dc12v-0.54-0.5
jqx-141ff-2c-z-5-dc24v-0.54-0.5
jqx-141ff-2c-z-5-dc3v-0.54-0.5
jqx-141ff-2c-z-5-dc48v-0.54-0.5
jqx-141ff-2c-z-5-dc5v-0.54-0.5
jqx-141ff-2c-z-5-dc9v-0.54-0.5
jqx-14fc1-c-s-10-dc12v-0.8-3.5
jqx-14fc1-c-s-10-dc15v-0.8-3.5

jqx-14fc1-c-s-10-dc24v-0.8-3.5
jqx-14fc1-c-s-10-dc3v-0.8-3.5
jqx-14fc1-c-s-10-dc48v-0.8-3.5
jqx-14fc1-c-s-10-dc5v-0.8-3.5
jqx-14fc1-c-s-10-dc6v-0.8-3.5
jqx-14fc1-c-s-10-dc9v-0.8-3.5
jqx-14fc1-c2-s-10-dc12v-0.8-3.5
jqx-14fc1-c2-s-10-dc15v-0.8-3.5
jqx-14fc1-c2-s-10-dc24v-0.8-3.5
jqx-14fc1-c2-s-10-dc3v-0.8-3.5
jqx-14fc1-c2-s-10-dc48v-0.8-3.5
jqx-14fc1-c2-s-10-dc5v-0.8-3.5
jqx-14fc1-c2-s-10-dc6v-0.8-3.5
jqx-14fc1-c2-s-10-dc9v-0.8-3.5
jqx-14fc2-2c-z-5-dc12v-5.0
jqx-14fc2-2c-z-5-dc15v-5.0
jqx-14fc2-2c-z-5-dc24v-5.0
jqx-14fc2-2c-z-5-dc3v-5.0
jqx-14fc2-2c-z-5-dc48v-5.0
jqx-14fc2-2c-z-5-dc5v-5.0
jqx-14fc2-2c-z-5-dc6v-5.0
jqx-14fc2-2c-z-5-dc9v-5.0
jqx-54fe-a-z-25a/250vac-b-dc12v-c-0.9
jqx-54fe-a-z-25a/250vac-b-dc24v-c-0.9
jqx-54fe-a-z-25a/250vac-b-dc48v-c-0.9
jqx-54fe-a-z-25a/250vac-b-dc6v-c-0.9
jqx-54fe-a-z-25a/250vac-b-dc9v-c-0.9
jqx-54w-a-20-dc110v-b

jqx-54w-a-20-dc12v-b

jqx-54w-a-20-dc24v-b

jqx-54w-a-20-dc48v-b

jqx-54w-a-20-dc5v-b

jqx-54w-a-20-dc6v-b

jqx-54w-a-20-dc9v-b

jqx-68f n/a, 17+

hls-14f3l-dc12v-c (jqx-14fc-2c) реле электромагнитное; икат.=12в; иконт.=5а

jqx-105f-1-1hst (12vdc) реле электромагнитное; икат.=12в; иконт.=250v ac 50/60hz; иконт.=16а

jqx-105f-1-1hst (24vdc) реле электромагнитное; икат.=24в; иконт.=250v ac 50/60hz; иконт.=16а

jqx-105f-4 (tr91f-220vac-sc-c) реле электромагнитное с фланцем; икат.=220v ac 50/60hz; иконт.=240v ac 50/60hz; иконт.=30а

jqx-10f-2z-dc12v реле электромагнитное; 12v; 8 контактов dpdt; 7.5a / 250v

jqx-10f-2z-dc24v реле электромагнитное; 24v; 8 контактов dpdt; 7.5a / 250v

jqx-115f-024-2zs4 реле электромагнитное; икат.=24в; иконт.=250v ac 50/60hz; иконт.=8а

jqx-115f/024-2zs4f (rt424024-24v) реле электромагнитное 24v

jqx-115f/048-2zs4f реле электромагнитное

jqx-13f реле электромагнитное 220/240vac; 2 контакта 7а; в плату

jqx-141ff-012-zspg реле 10а 250vac, 10а 30vdc

jqx-30f (t91, wj116-1a-12vdc-s) реле электромагнитное; u=12в

jqx-62f-012-1ht(555) реле электромагнитное; икат.=12в; иконт.=250v ac 50/60hz; иконт.=16а

реле jqx-13f1 отк

jqx-29f-1c-12vdc, ncr: реле: электромеханическое, ac-dc, икат: 12 в dc, рупр: 3 вт, икомм: 40 а, udc: 28 в, uac: 250 в ncr, реле: электромеханическое, ac-dc, икат: 12 в dc, рупр: 3 вт, икомм: 40 а, udc: 28 в, uac: 250 в

jqx-115f-048-1hs3a hongfa, Смотритецену на сайте.

jqx-115f/048-1z3af (jqx115f-2zs4(551) hongfa, Смотрите цену на сайте.

jqx-60f ., Смотрите
цену на сайте.

jqx-68f / 012-1zs Смотрите
цену на сайте.

jqx115f48vdc .hfo, Смотрите
цену на сайте.

dsl3510sljqx intel, i/o controller interface ic thunderbolt - 4 ch controller fc-csp288

s-8354a38mc-jqxt2u ablic, switching voltage regulators step-up swr pwm 18.7ua iq

13f-1 (jqx-13f1) 240vac 10a электромагнитные реле

13f-1 (jqx-13f1) 240vac 10a электромагнитные реле

14f1 (jqx-14f1) 12vdc 10a электромагнитные реле

14f1 (jqx-14f1) 12vdc 10a электромагнитные реле

jqx-29f-1c-12vdc ncr, реле электромеханическое

jqx-29f-1c-12vdc (заказ 3 дня) ncr, 20

jqx-29f-1c-12vdc ncr

wj175-3z socket [jqx-38fa] wanjia ***

реле jqx-13f 4z (3a/220в)

dsl3510l s ljqx intel, i/o controller interface ic thunderbolt - 4 ch controller fc-csp288. мин.: 4шт.

jqx-29f-1c-12vdc ncr, . мин.: 23шт.

s-8354a38mc-jqxt2u sii semiconductor corporation, ic reg boost 3.8v 0.3a sot23-5. мин.: 42шт.

dsl3510l s ljqx intel

jqx-29f-1c-12vdc miscellaneous

jqx-29f-1c-24vdc miscellaneous

jqx-58f-1c-12vdc. miscellaneous

14ff-2z-c3-2 (h=21mm) для реле hf-141fh, jqx-141ff панель для реле на дин-рейку hongfa, оптовая цена от 50 шт.

14ff-2z-c3-3 (h=26mm) для реле hf140ff/hf14fw, jqx14fc. hf-115fp 14ff-2z-c3-3 (h=26mm) для реле hf140ff/hf14fw, jqx14fc, hf-115fp панель для реле на дин-рейку hongfa, оптовая цена от 50 шт.

jqx-13f-2c-a-12vdc-1 forward, оптовая цена от 25 шт.

jqx-13f-2c-a-24vdc-1 forward, оптовая цена от 25 шт.

jqx-141ff-2c-z-5a-24vdc-0.54 pbf снято с производства. nt75 в замен. forward, оптовая цена от 25 шт.

jqx-141ff-2c-z-5a-48vdc-0.54 снято с производства. nt75 в замен. forward, оптовая цена от 25 шт.

jqx-14fc-2c-24vac asiaon, оптовая цена от 25 шт.

jqx-14fc-2c-24vdc asiaon, оптовая цена от 25 шт.

jqx-14fc2-2c-z-5-dc12v-5 forward, оптовая цена от 15 шт.

jqx-29f-1c-12vdc ncr, оптовая цена от 40 шт.

jqx-30f/2z-12vdc оптовая цена от 21 шт.

jqx-30f/2z-220vac оптовая цена от 16 шт.

jqx-30f/2z-24vdc оптовая цена от 16 шт.

jqx-38f/3z-220vac оптовая цена от 16 шт.

jqx-40f/2z-220vac оптовая цена от 11 шт.

jqx-40f/2z-24vdc оптовая цена от 11 шт.

jqx-80f/1z-220vac оптовая цена от 11 шт.

14ff-2z-c3-2 (h=21mm) для реле hf-141fh, jqx-141ff hongfa

14ff-2z-c3-3 (h=26mm) для реле hf140ff/hf14fw, jqx14fc. hf-115fp hongfa

jqx-102f-az-20-dc12v-0.9 rohs forward

jqx-13f-2c-a-12vdc-1 forward

jqx-13f-2c-a-24vdc-1 forward

jqx-13f-2c-a-ac220v-1l forward

jqx-141ff-2c-16a-dc48v forward

jqx-141ff-2c-z-5a-12vdc-0.54 forward

jqx-141ff-2c-z-5a-24vdc-0.54 pbf forward

jqx-141ff-2c-z-5a-48vdc-0.54 forward

jqx-14fc-2c-24vac asiaon

jqx-14fc-2c-24vdc asiaon

jqx-14fc-2z-230vac asiaon

jqx-14fc2-2c-z-5-dc12v-5 forward

jqx-29f-1c-12vdc ncr

jqx-30f/2z-12vdc реле, 2 переключающих контакта 250в 30а, катушка 12в постоянного напряжения потребление катушки 1.5w

jqx-30f/2z-220vac реле, 2 переключающих контакта 250в 30а, катушка 220в переменного напряжения, потребление катушки 2.5w

jqx-30f/2z-24vdc реле, 2 переключающих контакта 250в 30а, катушка 24в постоянного напряжения

jqx-38f/3z-220vac реле, 3 переключающих группы контактов 250в 30а, катушка 220в переменного напряжения

jqx-40f/2z-220vac реле, 2 переключающих контакта 250vac 40а, катушка 220в переменного напряжения

jqx-40f/2z-24vdc реле, 2 переключающих контакта 250vac 40а, катушка 24vdc постоянного напряжения

jqx-80f/1z-220vac реле, 1 переключающий контакт 250vac 80а

13f-1 (jqx-13f1) 12vdc 10а реле

13f-1 (jqx-13f1) 240vac 10а реле

13f-1 (jqx-13f1) 24vdc 10а реле

14f1 (jqx-14f1) 12vdc 10а реле

14f1 (jqx-14f1) 24vdc 10а реле

14f1 (jqx-14f1) 5vdc 10а реле

реле ~220vac 30а 2+6 pin jqx-30f/2z-220vac два перекидных контакта.

реле 12v 10а 8 pin (общ. назнач.) (под ptf08a-01) jqx-13f-1c

реле 12v 16/20а 4 pin+2 клеммы (на плату) jqx-62f 012-1h(555) на водонагреватель

реле 12v 16/20а 4 pin+2 клеммы (на плату) jqx-62f 012-1h(555) на водонагреватель от 3шт

реле 12v 30а 4 pin (на плату) jqx-105f-1-012d-1hs (jt105f-1-012d-1hs t90)

реле 12v 30а 6pin (на плату) jqx-15f (t90) (832)=t9as1d12-12=832a-1a-c-b 12v

реле 12v 60а 2 pin +3 клеммы jqx-60f-1z (демонтаж) под крепеж = hhc71g-1c-24vdc 250vac (стабилизатор снр1-0-10ква)

реле 24v 5 pin (на плату) az761-1c-24de 12а (jqx-14f1)

реле 24v 5 pin (на плату) az761-1cb-24d 12а (jqx-14f1)

реле 24v 5 pin (на плату) az761-1cb-24de 12а (jqx-14f1)

реле 24v 5 pin (на плату) frm10n-1cs1 dc24v 12а (jqx-14f1)

реле 24v 5 pin (на плату) jqx-115f 024-1zs1(551) 12a (jqx-14f1)

реле 24v 60a 2 pin +3 клеммы hhc71g-1c-24vdc 250vac jqx-60f-1z под динрейку

реле 48v 30a 6pin (на плату) jqx-15f(t90)-1h

реле 48v 4 pin (на плату) 457170480310 16a 250v finder =hf115f-q / 048-1h jqx-115f-q (hf115f-q)
048-1h (555) 48vdc 18a 250vac 4pin

реле 5v 5 pin (на плату) jqx-14fc-1z dc5v 10a

реле 5v 5 pin (на плату) smi-05vdc-sl-c 10a (jqx-14f1)

реле 5v 5 pin (на плату) smi-05vdc-sl-c 10a (jqx-14f1) от 5шт

реле 5v 8 pin (на плату) smih-05vdc-sl-c 16a (jqx-14f2)

реле~220v ac 10a 8 pin (общ. назнач.) jqx-13f-2 (под ptf08a-01)

реле~220vac 30a (2 клеммы +2клеммы) jqx-105f-4 / 220ak-1hs (hf105f-4)

13f-1 (jqx-13f1) 12vdc 10a

13f-1 (jqx-13f1) 240vac 10a

13f-1 (jqx-13f1) 24vdc 10a

14f1 (jqx-14f1) 12vdc 10a

14f1 (jqx-14f1) 24vdc 10a

14f1 (jqx-14f1) 5vdc 10a

jqx-29f-1c-12vdc ncr

jqx-29f-1c-12vdc

jqx-30f/2z-12vdc реле, 2 переключающих контакта 250в 30а, катушка 12в постоянного напряжения потребление катушки 1.5w

jqx-30f/2z-220vac реле, 2 переключающих контакта 250в 30а, катушка 220в переменного напряжения, потребление катушки 2.5w

jqx-30f/2z-24vdc реле, 2 переключающих контакта 250в 30а, катушка 24в постоянного напряжения

jqx-38f/3z-220vac реле, 3 переключающих группы контактов 250в 30а, катушка 220в переменного напряжения

jqx-40f/2z-220vac реле, 2 переключающих контакта 250vac 40а, катушка 220в переменного напряжения

jqx-40f/2z-24vdc реле, 2 переключающих контакта 250vac 40а, катушка 24vdc постоянного напряжения

jqx-80f/1z-220vac реле, 1 переключающий контакт 250vac 80a

`13f-1 (jqx-13f1) 240vac 10a 2016

`13f-1 (jqx-13f1) 240vac 10a 2017

`14f1 (jqx-14f1) 12vdc 10a 2017

`14f1 (jqx-14f1) 12vdc 10a 2012

jqx-13f 4z (3a/220в)

jqx-16f(t91) 1a 12vdc hat902a мощное 24vdc, 20a, 1переключение shenle

13f-1 (jqx-13f1) 240vac 10a // china

14f1 (jqx-14f1) 12vdc 10a // china

14ff-2z-c3-2 (h=21mm) для реле hf-141fh. jqx-141ff/hongfa/ moq>50 hongfa

jqx-13f-2c-a-12vdc-1 /forward/ moq>25 forward

jqx-13f-2c-a-24vdc-1 /forward/ moq>25 forward

jqx-13f1 /ad1/ moq>2 ad1

jqx-141ff-2c-z-5a-48vdc-0.54 /forward/ moq>25 forward

jqx-14fc2-2c-z-5-dc12v-5 /forward relay/ moq>15 forward relay

jqx-14fc2-2c-z-5-dc12v-5 /forward/ moq>15 forward

jqx-29f-1c-12vdc /ncr/ moq>85 ncr

jqx-30f/2z-12vdc // moq>6

jqx-30f/2z-220vac // moq>16

jqx-30f/2z-24vdc // moq>8

jqx-38f/3z-220vac // moq>16

jqx-40f/2z-220vac // moq>11

jqx-40f/2z-24vdc // moq>3

jqx-80f/1z-220vac // moq>3

mcjqx-13f-ke2c-110vac /multicomp/ moq> 150 multicomp

mcjqx-13f-ke2c-230vac /multicomp/ moq> 150 multicomp

mcjqx-13f-ke2c-24vac /multicomp/ moq> 150 multicomp

mcjqx-13f-ke2c-24vdc /multicomp/ moq> 150 multicomp

mcjqx-13f-ke4c-110vac /multicomp/ moq> 100 multicomp
mcjqx-13f-ke4c-230vac /multicomp/ moq> 150 multicomp
mcjqx-13f-ke4c-24vac /multicomp/ moq> 100 multicomp
mcjqx-13f-ke4c-24vdc /multicomp/ moq> 150 multicomp
mcjqx-13f-kf2c-110vac /multicomp/ moq> 100 multicomp
mcjqx-13f-kf2c-230vac /multicomp/ moq> 100 multicomp
mcjqx-13f-kf2c-24vac /multicomp/ moq> 100 multicomp
mcjqx-13f-kf2c-24vdc /multicomp/ moq> 150 multicomp
mcjqx-13f-kf4c-110vac /multicomp/ moq> 100 multicomp
mcjqx-13f-kf4c-230vac /multicomp/ moq> 100 multicomp
mcjqx-13f-kf4c-24vac /multicomp/ moq> 100 multicomp
mcjqx-13f-kf4c-24vdc /multicomp/ moq> 150 multicomp
mcjqx-13f-ly2cl-110vac /multicomp/ moq> 100 multicomp
mcjqx-13f-ly2cl-230vac /multicomp/ moq> 150 multicomp
mcjqx-13f-ly2cl-24vac /multicomp/ moq> 100 multicomp
mcjqx-13f-ly2cl-24vdc /multicomp/ moq> 150 multicomp
13f-1 (jqx-13f1) 240vac 10a
14f1 (jqx-14f1) 12vdc 10a
jqx-13f4z(3a/220в)
jqx-29f-1c-12vdc ncr
jqx-30f/2z-12vdc
jqx-30f/2z-220vac
jqx-30f/2z-24vdc
jqx-38f/3z-220vac
jqx-40f/2z-220vac
jqx-40f/2z-24vdc
jqx-80f/1z-220vac
13f-1 (jqx-13f1) 240vac 10a

14f1 (jqx-14f1) 12vdc 10a
реле имп, 24v jqx-141ff-2c-z
реле имп, 220v jqx-13f-2 (scl)
14fc 24vdc 10a (jqx)
13f-1 (jqx-13f1) 24vdc 10a электромагнитные реле (импорт)
13f-1 (jqx-13f1) 240vac 10a электромагнитные реле (импорт)
14f1 (jqx-14f1) 12vdc 10a электромагнитные реле (импорт)
13f-1 (jqx-13f1) 24vdc 10a электромагнитные реле (импорт)
13f-1 (jqx-13f1) 240vac 10a электромагнитные реле (импорт)
14f1 (jqx-14f1) 12vdc 10a электромагнитные реле (импорт)
13f-1 (jqx-13f1) 12vdc 10a ban
13f-1 (jqx-13f1) 240vac 10a aea
14f1 (jqx-14f1) 12vdc 10a aea
14ff-2z-c3-2 (h=21mm) для реле hf-141fh, jqx-141ff asahi
14ff-2z-c3-3 (h=26mm) для реле hf140ff/hf14fw, jqx14fc. hf-115fp asahi
jqx-13f 4z (3a/220в) american monster
jqx-13f-2c-a-12vdc-1 asahi
jqx-13f-2c-a-24vdc-1 asahi
jqx-141ff-2c-z-5a-24vdc-0.54 pbf asahi
jqx-141ff-2c-z-5a-48vdc-0.54 asahi
jqx-14fc-2c-24vac asahi
jqx-14fc-2c-24vdc asahi
jqx-14fc2-2c-z-5-dc12v-5 asahi
jqx-29f-1c-12vdc 3m, r_wj172
jqx-29f-1c-12vdc barnier
jqx-29f-1c-12vdc 3m
jqx-30f/2z-12vdc 4d
jqx-30f/2z-220vac 4d

jqx-30f/2z-24vdc 4d
jqx-38f/3z-220vac 4d
jqx-40f/2z-220vac 4d
jqx-40f/2z-24vdc 4d
jqx-80f/1z-220vac 4d
реле t90 12vdc (832)(jqx-15f) berus
реле t90 24vdc (832)(jqx-15f) berus
реле t90 5vdc (832)(jqx-15f) berus
hat902as-dc12 shenle (аналог jqx-16f(t91)) **реле,контакты
jqx-115f-005-1hs3f5vhongfa **резисторы
jqx-58f-1c-dc12v (hhc71g-1c) **реле,контакты
jqx-13f-2c-a-24vdc-1 ningbo forward relay corporation ltd.
jqx-29f-1c-12vdc ncr industrial clion relay co., ltd.
13f-1 (jqx-13f1) 240vac 10a электромагнитные реле (импорт)
13f-1 (jqx-13f1) 24vdc 10a электромагнитные реле (импорт)
14f1 (jqx-14f1) 12vdc 10a электромагнитные реле (импорт)
jqx-115f-005-1hs3f реле 5v (б/гр) hongfa
jqx-13f 4z (3a/220в) реле электромагнитные импортные
jqx-29f-1c-12vdc ncr
jqx-58f-1c-12vdc ncr
jqx-29f-1c-12vdc ncr, реле электромеханическое
jqx-58f-1c-12vdc ncr, реле электромеханическое
jqx-115f-005-1hs3f реле 5v
jqx-13f 4z (3a/220в)
jqx-29f-1c-12vdc
jqx-29f-1c-12vdc реле
jqx-60f, 60a-ac1 реле
jqx-29f-1c-12vdc ncr

wj175-3z socket [jqx-38fa] wanjia, ***

13f-1 (jqx-13f1) 24vdc 10a

13f-1 (jqx-13f1) 12vdc 10a

13f-1 (jqx-13f1) 240vac 10a

13f-1 (jqx-13f1) 24vdc 10a

14ff-2z-c3-2 (h=21mm) для реле hf-141fh, jqx-141ff

14ff-2z-c3-3 (h=26mm) для реле hf140ff/hf14fw, jqx14fc. hf-115fp

dsl3510l s ljqx intel, ис, контроллер интерфейса ввода вывода thunderbolt - 4 ch controller fc-csp288

gw pslr32.cm-hujq-xx35-l1m2-120-r18-xx osram opto semiconductors inc., led smd

gw pslr32.cm-hujq-xx36-l1m2-120-r18-xx osram opto semiconductors inc., led smd

jqx-102f-az-20-dc12v-0.9 rohs

jqx-115f-005-1hs3f реле 5v

jqx-115f-012-1hs3a(555) dip hf

jqx-115f-012-2zs4(551) dip hf

jqx-115f-024-1hs3a(555) dip hf

jqx-115f-024-1zs3 dip hf

jqx-118f 012-1zs1t

jqx-12f-2z-ac220

jqx-13f-2c-a-12vdc-1

jqx-13f-2c-a-24vdc-1

jqx-13f-2c-a-ac220v-1l

jqx-141ff-2c-16a-dc48v

jqx-141ff-2c-z-5a-12vdc-0.54

jqx-141ff-2c-z-5a-24vdc-0.54 pbf

jqx-141ff-2c-z-5a-48vdc-0.54

jqx-14fc-2c-24vac

jqx-14fc-2c-24vdc

jqx-14fc-2z-230vac

jqx-14fc2-2c-z-5-dc12v-5

jqx-29f-1c-12vdc

jqx-30f 2z-220vac

jqx-30f/2z-220vac

jqx-38f/3z-220vac

jqx-40f 2z-220vac

jqx-40f/2z-220vac

jqx-68f-024-1zst, реле 24vdc, 8a/250vac

jqx-80f/1z-220vac

s-8354a38mc-jqxt2g ablic u.s.a. inc., ic reg boost 3.8v 0.3a sot23-5

s-8354a38mc-jqxt2u sii semiconductor, импульсные регуляторы напряжения step-up swr pwm 18.7ua iq

s-8354a38mc-jqxt2u ablic u.s.a. inc., ic reg boost 3.8v 0.3a sot23-5

dsl3510l s ljqx intel, ис, контроллер интерфейса ввода вывода thunderbolt - 4 ch controller fc-csp288

gw pslr32.cm-hujq-xx35-l1m2-120-r18-xx osram opto semiconductors inc., led smd

gw pslr32.cm-hujq-xx36-l1m2-120-r18-xx osram opto semiconductors inc., led smd

jqx-13f-2z-dc24v

mcjqx-13f-ke2c-110vac multicomп, power relay, 110vac, 5a, dpdt, socket

mcjqx-13f-ke2c-230vac multicomп, power relay, 230vac, 5a, dpdt, socket

mcjqx-13f-ke2c-24vac multicomп, power relay, 24vac, 5a, dpdt, socket

mcjqx-13f-ke2c-24vdc multicomп, power relay, 24vdc, 5a, dpdt, socket

mcjqx-13f-ke4c-110vac multicomп, power relay, 110vac, 5a, 4pdt, socket

mcjqx-13f-ke4c-230vac multicomп, power relay, 230vac, 5a, 4pdt, socket

mcjqx-13f-ke4c-24vac multicomп, power relay, 24vac, 5a, 4pdt, socket

mcjqx-13f-ke4c-24vdc multicomп, power relay, 24vdc, 5a, 4pdt, socket

mcjqx-13f-kf2c-110vac multicomп, power relay, 110vac, 10a, dpdt, socket

mcjqx-13f-kf2c-230vac multicomп, power relay, 230vac, 10a, dpdt, socket

mcjqx-13f-kf2c-24vac multicomп, power relay, 24vac, 10a, dpdt, socket

mcjqx-13f-kf2c-24vdc multicomп, power relay, 24vdc, 10a, dpdt, socket

mcjqx-13f-kf4c-110vac multicomп, power relay, 110vac, 5a, 4pdt, socket
mcjqx-13f-kf4c-230vac multicomп, power relay, 230vac, 5a, 4pdt, socket
mcjqx-13f-kf4c-24vac multicomп, power relay, 24vac, 5a, 4pdt, socket
mcjqx-13f-kf4c-24vdc multicomп, power relay, 24vdc, 5a, 4pdt, socket
mcjqx-13f-ly2cl-110vac multicomп, power relay, 110vac, 10a, dpdt, socket
mcjqx-13f-ly2cl-230vac multicomп, power relay, 230vac, 10a, dpdt, socket
mcjqx-13f-ly2cl-24vac multicomп, power relay, 24vac, 10a, dpdt, socket
mcjqx-13f-ly2cl-24vdc multicomп, power relay, 24vdc, 10a, dpdt, socket
s-8354a38mc-jqxt2g sii semiconductor, регуляторы напряжения - импульсные регуляторы step-up
swr pwm 18.7ua iq
s-8354a38mc-jqxt2g ablic u.s.a. inc., ic reg boost 3.8v 0.3a sot23-5
s-8354a38mc-jqxt2g seiko semiconductors, регуляторы напряжения - импульсные регуляторы
step-up swr pwm 18.7ua iq
s-8354a38mc-jqxt2u ablic u.s.a. inc., ic reg boost 3.8v 0.3a sot23-5
13f-1 (jqx-13f1) 240vac 10a
14f1 (jqx-14f1) 12vdc 10a
14ff-2z-c3-2 (h=21mm) для реле hf-141fh, jqx-141ff
14ff-2z-c3-3 (h=26mm) для реле hf140ff/hf14fw, jqx14fc. hf-115fp
jqx-13f-2c-a-12vdc-1
jqx-13f-2c-a-24vdc-1
jqx-13f-2c-a-ac220v-1l
jqx-141ff-2c-z-5a-48vdc-0.54
jqx-14fc2-2c-z-5-dc12v-5
реле имп. 24v jqx-141ff-2c-z
реле имп.220v jqx-13f-2 (scl)
hhc68a(jqx-13f)-2z-24vdc
jqx-102f/012
jqx-105f-1-012-d1hst-555
jqx-115f-006-1hs3-551

jqx-115f-012-1hs3-551
jqx-115f-012-1hs3a(555)
jqx-115f-012-1z1a 555
jqx-115f-012-1z3a 555
jqx-115f-012-1zs1
jqx-115f-012-1zs3-551
jqx-115f-012-1zs3a (555)
jqx-115f-012-1zs3b
jqx-115f-012-2zs4
jqx-115f-024-1z3
jqx-115f-024-1z3a-555
jqx-115f-024-1zs1
jqx-115f-024-2zs4
jqx-115f-024-2zs4b
jqx-115f-048-2zs4b-610-555
jqx-115f-t-005-1z3-551
jqx-118f-024-1zs1t-555
jqx-13f
jqx-14f-w012-z
jqx-14ff/012-1zw
jqx-15f-l-12v
jqx-15f-l-dc12v
jqx-68f-006-1hs-551
jqx-68f-012-1zs-551
jqx-68f-012-1zsb-555
jqx-68f-024-1zs
jqx-68f-024-1zs-551
jqx-68f-024-1zsb-555

jqx-68f-12v-1zs

jqx-68f-12vdc-1zs

jqx-68f-1zs-12v

jqx-68f-1zs-12vdc

jqx-68f-1zs-24v

jqx-68f-1zs-24vdc

jqx-68f-24v-1zs

jqx-68f-24vdc-1zs

jqx115f0121hs3

s-8354a38mc-jqxt2g

13f-1 (jqx-13f1) 240vac 10a реле

14f1 (jqx-14f1) 12vdc 10a реле

acvx1220-freq-l-j-qxx abracon

dsl3510l s ljqx intel, ис, контроллер интерфейса ввода вывода thunderbolt - 4 ch controller fc-csp288

hhc68a(jqx-13f)-2z-24vdc glenair, available

jqx-102f реле

jqx-102f/012 hongfa, dip 2006

jqx-102f005 реле

jqx-102f012 реле

jqx-102f024 реле

jqx-102f048 реле

jqx-102fa huaxinan [huaxinan electronics co.,ltd], can welded directly onto pcb

jqx-102faz20bdc12c0.9 реле

jqx-102faz20bdc12v0.9 dblectro [db lectro inc], used household appliance like air conditioning

jqx-102faz20bdc24c0.9 реле

jqx-102faz20bdc24v0.9 dblectro [db lectro inc], used household appliance like air conditioning

jqx-102faz20bdc48c0.9 реле

jqx-102faz20bdc48v0.9 dblectro [db lectro inc], used household appliance like air conditioning

jqx-102faz20bdc5c0.9 реле

jqx-102faz20bdc5v0.9 dblectro [db lectro inc], used household appliance like air conditioning

jqx-102faz20nildc12v0.9 dblectro [db lectro inc], used household appliance like air conditioning

jqx-102faz20nildc24v0.9 dblectro [db lectro inc], used household appliance like air conditioning

jqx-102faz20nildc48v0.9 dblectro [db lectro inc], used household appliance like air conditioning

jqx-102faz20nildc5v0.9 dblectro [db lectro inc], used household appliance like air conditioning

jqx-102faz250bdc12c0.9 реле

jqx-102faz250bdc24c0.9 реле

jqx-102faz250bdc48c0.9 реле

jqx-102faz250bdc5c0.9 реле

jqx-102fp005 реле

jqx-102fp012 реле

jqx-102fp024 реле

jqx-102fp048 реле

jqx-102fpt005 реле

jqx-102fpt012 реле

jqx-102fpt024 реле

jqx-102fpt048 реле

jqx-102ft005 реле

jqx-102ft012 реле

jqx-102ft024 реле

jqx-102ft048 реле

jqx-102f_05 реле

jqx-105-4lack1dnil реле

jqx-105-4lack1ds реле

jqx-105-4lack1hnil реле

jqx-105-4lack1hs реле

jqx-105-4lack1znil реле

jqx-105-4lack1zs	реле	
jqx-105-4lacnil1dnil	реле	
jqx-105-4lacnil1ds	реле	
jqx-105-4lacnil1hnil	реле	
jqx-105-4lacnil1hs	реле	
jqx-105-4lacnil1znil	реле	
jqx-105-4lacnil1zs	реле	
jqx-105-4ldck1dnil	реле	
jqx-105-4ldck1ds	реле	
jqx-105-4ldck1hnil	реле	
jqx-105-4ldck1hs	реле	
jqx-105-4ldck1znil	реле	
jqx-105-4ldck1zs	реле	
jqx-105-4ldcnil1dnil	реле	
jqx-105-4ldcnil1ds	реле	
jqx-105-4ldcnil1hnil	реле	
jqx-105-4ldcnil1hs	реле	
jqx-105-4ldcnil1znil	реле	
jqx-105-4ldcnil1zs	реле	
jqx-105f-1	реле	
jqx-105f-1-012-d1hst-555		glenair
jqx-105f-1018a61dstf	реле	
jqx-105f-1018a61hstf	реле	
jqx-105f-1018a61zstf	реле	
jqx-105f-1018at1dstf	реле	
jqx-105f-1018at1hstf	реле	
jqx-105f-1018at1zstf	реле	
jqx-105f-1018d61dstf	реле	

jqx-105f-1018d61hstf реле
jqx-105f-1018d61zstf реле
jqx-105f-1018dt1dstf реле
jqx-105f-1018dt1hstf реле
jqx-105f-1018dt1zstf реле
jqx-105f-2 etc1 [list of unclassified manufacturers], 30a pole pcb&qc terminal
jqx-105f-2l etc1 [list of unclassified manufacturers], 30a pole pcb&qc terminal
jqx-105f-4 реле
jqx-105f-4/005d1d реле
jqx-105f-4/005d1df реле
jqx-105f-4/005d1dt реле
jqx-105f-4/005d1dtf реле
jqx-105f-4/005d1h реле
jqx-105f-4/005d1hf реле
jqx-105f-4/005d1ht реле
jqx-105f-4/005d1htf реле
jqx-105f-4/005d1z реле
jqx-105f-4/005d1zf реле
jqx-105f-4/005d1zt реле
jqx-105f-4/005d1ztf реле
jqx-105f-4/005dk1d реле
jqx-105f-4/005dk1df реле
jqx-105f-4/005dk1dt реле
jqx-105f-4/005dk1dtf реле
jqx-105f-4/005dk1h реле
jqx-105f-4/005dk1hf реле
jqx-105f-4/005dk1ht реле
jqx-105f-4/005dk1htf реле

jqx-105f-4/005dk1z	реле
jqx-105f-4/005dk1zf	реле
jqx-105f-4/005dk1zt	реле
jqx-105f-4/005dk1ztf	реле
jqx-105f-4/009d1d	реле
jqx-105f-4/009d1df	реле
jqx-105f-4/009d1dt	реле
jqx-105f-4/009d1dtf	реле
jqx-105f-4/009d1h	реле
jqx-105f-4/009d1hf	реле
jqx-105f-4/009d1ht	реле
jqx-105f-4/009d1htf	реле
jqx-105f-4/009d1z	реле
jqx-105f-4/009d1zf	реле
jqx-105f-4/009d1zt	реле
jqx-105f-4/009d1ztf	реле
jqx-105f-4/009dk1d	реле
jqx-105f-4/009dk1df	реле
jqx-105f-4/009dk1dt	реле
jqx-105f-4/009dk1dtf	реле
jqx-105f-4/009dk1h	реле
jqx-105f-4/009dk1hf	реле
jqx-105f-4/009dk1ht	реле
jqx-105f-4/009dk1htf	реле
jqx-105f-4/009dk1z	реле
jqx-105f-4/009dk1zf	реле
jqx-105f-4/009dk1zt	реле
jqx-105f-4/009dk1ztf	реле

jqx-105f-4/012a1d	реле
jqx-105f-4/012a1df	реле
jqx-105f-4/012a1dt	реле
jqx-105f-4/012a1dtf	реле
jqx-105f-4/012a1h	реле
jqx-105f-4/012a1hf	реле
jqx-105f-4/012a1ht	реле
jqx-105f-4/012a1htf	реле
jqx-105f-4/012a1z	реле
jqx-105f-4/012a1zf	реле
jqx-105f-4/012a1zt	реле
jqx-105f-4/012a1ztf	реле
jqx-105f-4/012ak1d	реле
jqx-105f-4/012ak1df	реле
jqx-105f-4/012ak1dt	реле
jqx-105f-4/012ak1dtf	реле
jqx-105f-4/012ak1h	реле
jqx-105f-4/012ak1hf	реле
jqx-105f-4/012ak1ht	реле
jqx-105f-4/012ak1htf	реле
jqx-105f-4/012ak1z	реле
jqx-105f-4/012ak1zf	реле
jqx-105f-4/012ak1zt	реле
jqx-105f-4/012ak1ztf	реле
jqx-105f-4/018d1d	реле
jqx-105f-4/018d1df	реле
jqx-105f-4/018d1dt	реле
jqx-105f-4/018d1dtf	реле

jqx-105f-4/018d1h	реле
jqx-105f-4/018d1hf	реле
jqx-105f-4/018d1ht	реле
jqx-105f-4/018d1htf	реле
jqx-105f-4/018d1z	реле
jqx-105f-4/018d1zf	реле
jqx-105f-4/018d1zt	реле
jqx-105f-4/018d1ztf	реле
jqx-105f-4/018dk1d	реле
jqx-105f-4/018dk1df	реле
jqx-105f-4/018dk1dt	реле
jqx-105f-4/018dk1dtf	реле
jqx-105f-4/018dk1h	реле
jqx-105f-4/018dk1hf	реле
jqx-105f-4/018dk1ht	реле
jqx-105f-4/018dk1htf	реле
jqx-105f-4/018dk1z	реле
jqx-105f-4/018dk1zf	реле
jqx-105f-4/018dk1zt	реле
jqx-105f-4/018dk1ztf	реле
jqx-105f-4/024a1d	реле
jqx-105f-4/024a1df	реле
jqx-105f-4/024a1dt	реле
jqx-105f-4/024a1dtf	реле
jqx-105f-4/024a1h	реле
jqx-105f-4/024a1hf	реле
jqx-105f-4/024a1ht	реле
jqx-105f-4/024a1htf	реле

jqx-105f-4/024a1z	реле
jqx-105f-4/024a1zf	реле
jqx-105f-4/024a1zt	реле
jqx-105f-4/024a1ztf	реле
jqx-105f-4/024ak1d	реле
jqx-105f-4/024ak1df	реле
jqx-105f-4/024ak1dt	реле
jqx-105f-4/024ak1dtf	реле
jqx-105f-4/024ak1h	реле
jqx-105f-4/024ak1hf	реле
jqx-105f-4/024ak1ht	реле
jqx-105f-4/024ak1htf	реле
jqx-105f-4/024ak1z	реле
jqx-105f-4/024ak1zf	реле
jqx-105f-4/024ak1zt	реле
jqx-105f-4/024ak1ztf	реле
jqx-105f-4/048d1d	реле
jqx-105f-4/048d1df	реле
jqx-105f-4/048d1dt	реле
jqx-105f-4/048d1dtf	реле
jqx-105f-4/048d1h	реле
jqx-105f-4/048d1hf	реле
jqx-105f-4/048d1ht	реле
jqx-105f-4/048d1htf	реле
jqx-105f-4/048d1z	реле
jqx-105f-4/048d1zf	реле
jqx-105f-4/048d1zt	реле
jqx-105f-4/048d1ztf	реле

jqx-105f-4/048dk1d	реле
jqx-105f-4/048dk1df	реле
jqx-105f-4/048dk1dt	реле
jqx-105f-4/048dk1dtf	реле
jqx-105f-4/048dk1h	реле
jqx-105f-4/048dk1hf	реле
jqx-105f-4/048dk1ht	реле
jqx-105f-4/048dk1htf	реле
jqx-105f-4/048dk1z	реле
jqx-105f-4/048dk1zf	реле
jqx-105f-4/048dk1zt	реле
jqx-105f-4/048dk1ztf	реле
jqx-105f-4/070d1d	реле
jqx-105f-4/070d1df	реле
jqx-105f-4/070d1dt	реле
jqx-105f-4/070d1dtf	реле
jqx-105f-4/070d1h	реле
jqx-105f-4/070d1hf	реле
jqx-105f-4/070d1ht	реле
jqx-105f-4/070d1htf	реле
jqx-105f-4/070d1z	реле
jqx-105f-4/070d1zf	реле
jqx-105f-4/070d1zt	реле
jqx-105f-4/070d1ztf	реле
jqx-105f-4/070dk1d	реле
jqx-105f-4/070dk1df	реле
jqx-105f-4/070dk1dt	реле
jqx-105f-4/070dk1dtf	реле

jqx-105f-4/070dk1h	реле
jqx-105f-4/070dk1hf	реле
jqx-105f-4/070dk1ht	реле
jqx-105f-4/070dk1htf	реле
jqx-105f-4/070dk1z	реле
jqx-105f-4/070dk1zf	реле
jqx-105f-4/070dk1zt	реле
jqx-105f-4/070dk1ztf	реле
jqx-105f-4/110d1d	реле
jqx-105f-4/110d1df	реле
jqx-105f-4/110d1dt	реле
jqx-105f-4/110d1dtf	реле
jqx-105f-4/110d1h	реле
jqx-105f-4/110d1hf	реле
jqx-105f-4/110d1ht	реле
jqx-105f-4/110d1htf	реле
jqx-105f-4/110d1z	реле
jqx-105f-4/110d1zf	реле
jqx-105f-4/110d1zt	реле
jqx-105f-4/110d1ztf	реле
jqx-105f-4/110dk1d	реле
jqx-105f-4/110dk1df	реле
jqx-105f-4/110dk1dt	реле
jqx-105f-4/110dk1dtf	реле
jqx-105f-4/110dk1h	реле
jqx-105f-4/110dk1hf	реле
jqx-105f-4/110dk1ht	реле
jqx-105f-4/110dk1htf	реле

jqx-105f-4/110dk1z	реле
jqx-105f-4/110dk1zf	реле
jqx-105f-4/110dk1zt	реле
jqx-105f-4/110dk1ztf	реле
jqx-105f-4/120a1d	реле
jqx-105f-4/120a1df	реле
jqx-105f-4/120a1dt	реле
jqx-105f-4/120a1dtf	реле
jqx-105f-4/120a1h	реле
jqx-105f-4/120a1hf	реле
jqx-105f-4/120a1ht	реле
jqx-105f-4/120a1htf	реле
jqx-105f-4/120a1z	реле
jqx-105f-4/120a1zf	реле
jqx-105f-4/120a1zt	реле
jqx-105f-4/120a1ztf	реле
jqx-105f-4/120ak1d	реле
jqx-105f-4/120ak1df	реле
jqx-105f-4/120ak1dt	реле
jqx-105f-4/120ak1dtf	реле
jqx-105f-4/120ak1h	реле
jqx-105f-4/120ak1hf	реле
jqx-105f-4/120ak1ht	реле
jqx-105f-4/120ak1htf	реле
jqx-105f-4/120ak1z	реле
jqx-105f-4/120ak1zf	реле
jqx-105f-4/120ak1zt	реле
jqx-105f-4/120ak1ztf	реле

jqx-105f-4/277a1d	реле
jqx-105f-4/277a1df	реле
jqx-105f-4/277a1dt	реле
jqx-105f-4/277a1dtf	реле
jqx-105f-4/277a1h	реле
jqx-105f-4/277a1hf	реле
jqx-105f-4/277a1ht	реле
jqx-105f-4/277a1htf	реле
jqx-105f-4/277a1z	реле
jqx-105f-4/277a1zf	реле
jqx-105f-4/277a1zt	реле
jqx-105f-4/277a1ztf	реле
jqx-105f-4/277ak1d	реле
jqx-105f-4/277ak1df	реле
jqx-105f-4/277ak1dt	реле
jqx-105f-4/277ak1dtf	реле
jqx-105f-4/277ak1h	реле
jqx-105f-4/277ak1hf	реле
jqx-105f-4/277ak1ht	реле
jqx-105f-4/277ak1htf	реле
jqx-105f-4/277ak1z	реле
jqx-105f-4/277ak1zf	реле
jqx-105f-4/277ak1zt	реле
jqx-105f-4/277ak1ztf	реле
jqx-105f-4ack1dnil	реле
jqx-105f-4ack1ds	реле
jqx-105f-4ack1hnil	реле
jqx-105f-4ack1hs	реле

jqx-105f-4ack1znil	реле
jqx-105f-4ack1zs	реле
jqx-105f-4acnil1dnil	реле
jqx-105f-4acnil1ds	реле
jqx-105f-4acnil1hnil	реле
jqx-105f-4acnil1hs	реле
jqx-105f-4acnil1znil	реле
jqx-105f-4acnil1zs	реле
jqx-105f-4dck1dnil	реле
jqx-105f-4dck1ds	реле
jqx-105f-4dck1hnil	реле
jqx-105f-4dck1hs	реле
jqx-105f-4dck1znil	реле
jqx-105f-4dck1zs	реле
jqx-105f-4dcnil1dnil	реле
jqx-105f-4dcnil1ds	реле
jqx-105f-4dcnil1hnil	реле
jqx-105f-4dcnil1hs	реле
jqx-105f-4dcnil1znil	реле
jqx-105f-4dcnil1zs	реле
jqx-105f-4l/005d1d	реле
jqx-105f-4l/005d1df	реле
jqx-105f-4l/005d1dt	реле
jqx-105f-4l/005d1dtf	реле
jqx-105f-4l/005d1h	реле
jqx-105f-4l/005d1hf	реле
jqx-105f-4l/005d1ht	реле
jqx-105f-4l/005d1htf	реле

jqx-105f-4l/005d1z	реле
jqx-105f-4l/005d1zf	реле
jqx-105f-4l/005d1zt	реле
jqx-105f-4l/005d1ztf	реле
jqx-105f-4l/005dk1d	реле
jqx-105f-4l/005dk1df	реле
jqx-105f-4l/005dk1dt	реле
jqx-105f-4l/005dk1dtf	реле
jqx-105f-4l/005dk1h	реле
jqx-105f-4l/005dk1hf	реле
jqx-105f-4l/005dk1ht	реле
jqx-105f-4l/005dk1htf	реле
jqx-105f-4l/005dk1z	реле
jqx-105f-4l/005dk1zf	реле
jqx-105f-4l/005dk1zt	реле
jqx-105f-4l/005dk1ztf	реле
jqx-105f-4l/009d1d	реле
jqx-105f-4l/009d1df	реле
jqx-105f-4l/009d1dt	реле
jqx-105f-4l/009d1dtf	реле
jqx-105f-4l/009d1h	реле
jqx-105f-4l/009d1hf	реле
jqx-105f-4l/009d1ht	реле
jqx-105f-4l/009d1htf	реле
jqx-105f-4l/009d1z	реле
jqx-105f-4l/009d1zf	реле
jqx-105f-4l/009d1zt	реле
jqx-105f-4l/009d1ztf	реле

jqx-105f-4l/009dk1d реле
jqx-105f-4l/009dk1df реле
jqx-105f-4l/009dk1dt реле
jqx-105f-4l/009dk1dtf реле
jqx-105f-4l/009dk1h реле
jqx-105f-4l/009dk1hf реле
jqx-105f-4l/009dk1ht реле
jqx-105f-4l/009dk1htf реле
jqx-105f-4l/009dk1z реле
jqx-105f-4l/009dk1zf реле
jqx-105f-4l/009dk1zt реле
jqx-105f-4l/009dk1ztf реле
jqx-105f-4l/012a1d реле
jqx-105f-4l/012a1df реле
jqx-105f-4l/012a1dt реле
jqx-105f-4l/012a1dtf реле
jqx-105f-4l/012a1h реле
jqx-105f-4l/012a1hf реле
jqx-105f-4l/012a1ht реле
jqx-105f-4l/012a1htf реле
jqx-105f-4l/012a1z реле
jqx-105f-4l/012a1zf реле
jqx-105f-4l/012a1zt реле
jqx-105f-4l/012a1ztf реле
jqx-105f-4l/012ak1d реле
jqx-105f-4l/012ak1df реле
jqx-105f-4l/012ak1dt реле
jqx-105f-4l/012ak1dtf реле

jqx-105f-4l/012ak1h реле
jqx-105f-4l/012ak1hf реле
jqx-105f-4l/012ak1ht реле
jqx-105f-4l/012ak1htf реле
jqx-105f-4l/012ak1z реле
jqx-105f-4l/012ak1zf реле
jqx-105f-4l/012ak1zt реле
jqx-105f-4l/012ak1ztf реле
jqx-105f-4l/018d1d реле
jqx-105f-4l/018d1df реле
jqx-105f-4l/018d1dt реле
jqx-105f-4l/018d1dtf реле
jqx-105f-4l/018d1h реле
jqx-105f-4l/018d1hf реле
jqx-105f-4l/018d1ht реле
jqx-105f-4l/018d1htf реле
jqx-105f-4l/018d1z реле
jqx-105f-4l/018d1zf реле
jqx-105f-4l/018d1zt реле
jqx-105f-4l/018d1ztf реле
jqx-105f-4l/018dk1d реле
jqx-105f-4l/018dk1df реле
jqx-105f-4l/018dk1dt реле
jqx-105f-4l/018dk1dtf реле
jqx-105f-4l/018dk1h реле
jqx-105f-4l/018dk1hf реле
jqx-105f-4l/018dk1ht реле
jqx-105f-4l/018dk1htf реле

jqx-105f-4l/018dk1z реле
jqx-105f-4l/018dk1zf реле
jqx-105f-4l/018dk1zt реле
jqx-105f-4l/018dk1ztf реле
jqx-105f-4l/024a1d реле
jqx-105f-4l/024a1df реле
jqx-105f-4l/024a1dt реле
jqx-105f-4l/024a1dtf реле
jqx-105f-4l/024a1h реле
jqx-105f-4l/024a1hf реле
jqx-105f-4l/024a1ht реле
jqx-105f-4l/024a1htf реле
jqx-105f-4l/024a1z реле
jqx-105f-4l/024a1zf реле
jqx-105f-4l/024a1zt реле
jqx-105f-4l/024a1ztf реле
jqx-105f-4l/024ak1d реле
jqx-105f-4l/024ak1df реле
jqx-105f-4l/024ak1dt реле
jqx-105f-4l/024ak1dtf реле
jqx-105f-4l/024ak1h реле
jqx-105f-4l/024ak1hf реле
jqx-105f-4l/024ak1ht реле
jqx-105f-4l/024ak1htf реле
jqx-105f-4l/024ak1z реле
jqx-105f-4l/024ak1zf реле
jqx-105f-4l/024ak1zt реле
jqx-105f-4l/024ak1ztf реле

jqx-105f-4l/048d1d	реле
jqx-105f-4l/048d1df	реле
jqx-105f-4l/048d1dt	реле
jqx-105f-4l/048d1dtf	реле
jqx-105f-4l/048d1h	реле
jqx-105f-4l/048d1hf	реле
jqx-105f-4l/048d1ht	реле
jqx-105f-4l/048d1htf	реле
jqx-105f-4l/048d1z	реле
jqx-105f-4l/048d1zf	реле
jqx-105f-4l/048d1zt	реле
jqx-105f-4l/048d1ztf	реле
jqx-105f-4l/048dk1d	реле
jqx-105f-4l/048dk1df	реле
jqx-105f-4l/048dk1dt	реле
jqx-105f-4l/048dk1dtf	реле
jqx-105f-4l/048dk1h	реле
jqx-105f-4l/048dk1hf	реле
jqx-105f-4l/048dk1ht	реле
jqx-105f-4l/048dk1htf	реле
jqx-105f-4l/048dk1z	реле
jqx-105f-4l/048dk1zf	реле
jqx-105f-4l/048dk1zt	реле
jqx-105f-4l/048dk1ztf	реле
jqx-105f-4l/070d1d	реле
jqx-105f-4l/070d1df	реле
jqx-105f-4l/070d1dt	реле
jqx-105f-4l/070d1dtf	реле

jqx-105f-4l/070d1h	реле
jqx-105f-4l/070d1hf	реле
jqx-105f-4l/070d1ht	реле
jqx-105f-4l/070d1htf	реле
jqx-105f-4l/070d1z	реле
jqx-105f-4l/070d1zf	реле
jqx-105f-4l/070d1zt	реле
jqx-105f-4l/070d1ztf	реле
jqx-105f-4l/070dk1d	реле
jqx-105f-4l/070dk1df	реле
jqx-105f-4l/070dk1dt	реле
jqx-105f-4l/070dk1dtf	реле
jqx-105f-4l/070dk1h	реле
jqx-105f-4l/070dk1hf	реле
jqx-105f-4l/070dk1ht	реле
jqx-105f-4l/070dk1htf	реле
jqx-105f-4l/070dk1z	реле
jqx-105f-4l/070dk1zf	реле
jqx-105f-4l/070dk1zt	реле
jqx-105f-4l/070dk1ztf	реле
jqx-105f-4l/110d1d	реле
jqx-105f-4l/110d1df	реле
jqx-105f-4l/110d1dt	реле
jqx-105f-4l/110d1dtf	реле
jqx-105f-4l/110d1h	реле
jqx-105f-4l/110d1hf	реле
jqx-105f-4l/110d1ht	реле
jqx-105f-4l/110d1htf	реле

jqx-105f-4l/110d1z	реле
jqx-105f-4l/110d1zf	реле
jqx-105f-4l/110d1zt	реле
jqx-105f-4l/110d1ztf	реле
jqx-105f-4l/110dk1d	реле
jqx-105f-4l/110dk1df	реле
jqx-105f-4l/110dk1dt	реле
jqx-105f-4l/110dk1dtf	реле
jqx-105f-4l/110dk1h	реле
jqx-105f-4l/110dk1hf	реле
jqx-105f-4l/110dk1ht	реле
jqx-105f-4l/110dk1htf	реле
jqx-105f-4l/110dk1z	реле
jqx-105f-4l/110dk1zf	реле
jqx-105f-4l/110dk1zt	реле
jqx-105f-4l/110dk1ztf	реле
jqx-105f-4l/120a1d	реле
jqx-105f-4l/120a1df	реле
jqx-105f-4l/120a1dt	реле
jqx-105f-4l/120a1dtf	реле
jqx-105f-4l/120a1h	реле
jqx-105f-4l/120a1hf	реле
jqx-105f-4l/120a1ht	реле
jqx-105f-4l/120a1htf	реле
jqx-105f-4l/120a1z	реле
jqx-105f-4l/120a1zf	реле
jqx-105f-4l/120a1zt	реле
jqx-105f-4l/120a1ztf	реле

jqx-105f-4l/120ak1d реле
jqx-105f-4l/120ak1df реле
jqx-105f-4l/120ak1dt реле
jqx-105f-4l/120ak1dtf реле
jqx-105f-4l/120ak1h реле
jqx-105f-4l/120ak1hf реле
jqx-105f-4l/120ak1ht реле
jqx-105f-4l/120ak1htf реле
jqx-105f-4l/120ak1z реле
jqx-105f-4l/120ak1zf реле
jqx-105f-4l/120ak1zt реле
jqx-105f-4l/120ak1ztf реле
jqx-105f-4l/277a1d реле
jqx-105f-4l/277a1df реле
jqx-105f-4l/277a1dt реле
jqx-105f-4l/277a1dtf реле
jqx-105f-4l/277a1h реле
jqx-105f-4l/277a1hf реле
jqx-105f-4l/277a1ht реле
jqx-105f-4l/277a1htf реле
jqx-105f-4l/277a1z реле
jqx-105f-4l/277a1zf реле
jqx-105f-4l/277a1zt реле
jqx-105f-4l/277a1ztf реле
jqx-105f-4l/277ak1d реле
jqx-105f-4l/277ak1df реле
jqx-105f-4l/277ak1dt реле
jqx-105f-4l/277ak1dtf реле

jqx-105f-4l/277ak1h	реле
jqx-105f-4l/277ak1hf	реле
jqx-105f-4l/277ak1ht	реле
jqx-105f-4l/277ak1htf	реле
jqx-105f-4l/277ak1z	реле
jqx-105f-4l/277ak1zf	реле
jqx-105f-4l/277ak1zt	реле
jqx-105f-4l/277ak1ztf	реле
jqx-105f-4_04	реле
jqx-105f-5	etc1 [list of unclassified manufacturers], 30a pole board typ
jqx-105f-5l	etc1 [list of unclassified manufacturers], 30a pole board typ
jqx-10ff	реле
jqx-10ff/006a2zd	реле
jqx-10ff/006a2znil	реле
jqx-10ff/006a3z-1d	реле
jqx-10ff/006a3z-1nil	реле
jqx-10ff/006a3zd	реле
jqx-10ff/006a3znil	реле
jqx-10ff/006nil2zd	реле
jqx-10ff/006nil2znil	реле
jqx-10ff/006nil3z-1d	реле
jqx-10ff/006nil3z-1nil	реле
jqx-10ff/006nil3zd	реле
jqx-10ff/006nil3znil	реле
jqx-10ff/012a2zd	реле
jqx-10ff/012a2znil	реле
jqx-10ff/012a3z-1d	реле
jqx-10ff/012a3z-1nil	реле

jqx-10ff/012a3zd	реле
jqx-10ff/012a3znil	реле
jqx-10ff/012nil2zd	реле
jqx-10ff/012nil2znil	реле
jqx-10ff/012nil3z-1d	реле
jqx-10ff/012nil3z-1nil	реле
jqx-10ff/012nil3zd	реле
jqx-10ff/012nil3znil	реле
jqx-10ff/024a2zd	реле
jqx-10ff/024a2znil	реле
jqx-10ff/024a3z-1d	реле
jqx-10ff/024a3z-1nil	реле
jqx-10ff/024a3zd	реле
jqx-10ff/024a3znil	реле
jqx-10ff/024nil2zd	реле
jqx-10ff/024nil2znil	реле
jqx-10ff/024nil3z-1d	реле
jqx-10ff/024nil3z-1nil	реле
jqx-10ff/024nil3zd	реле
jqx-10ff/024nil3znil	реле
jqx-10ff/048a2zd	реле
jqx-10ff/048a2znil	реле
jqx-10ff/048a3z-1d	реле
jqx-10ff/048a3z-1nil	реле
jqx-10ff/048a3zd	реле
jqx-10ff/048a3znil	реле
jqx-10ff/048nil2zd	реле
jqx-10ff/048nil2znil	реле

jqx-10ff/048nil3z-1d	реле
jqx-10ff/048nil3z-1nil	реле
jqx-10ff/048nil3zd	реле
jqx-10ff/048nil3znil	реле
jqx-10ff/100a2zd	реле
jqx-10ff/100a2znil	реле
jqx-10ff/100a3z-1d	реле
jqx-10ff/100a3z-1nil	реле
jqx-10ff/100a3zd	реле
jqx-10ff/100a3znil	реле
jqx-10ff/100nil2zd	реле
jqx-10ff/100nil2znil	реле
jqx-10ff/100nil3z-1d	реле
jqx-10ff/100nil3z-1nil	реле
jqx-10ff/100nil3zd	реле
jqx-10ff/100nil3znil	реле
jqx-10ff/110a2zd	реле
jqx-10ff/110a2znil	реле
jqx-10ff/110a3z-1d	реле
jqx-10ff/110a3z-1nil	реле
jqx-10ff/110a3zd	реле
jqx-10ff/110a3znil	реле
jqx-10ff/110nil2zd	реле
jqx-10ff/110nil2znil	реле
jqx-10ff/110nil3z-1d	реле
jqx-10ff/110nil3z-1nil	реле
jqx-10ff/110nil3zd	реле
jqx-10ff/110nil3znil	реле

jqx-10ff/120a2zd	реле
jqx-10ff/120a2znil	реле
jqx-10ff/120a3z-1d	реле
jqx-10ff/120a3z-1nil	реле
jqx-10ff/120a3zd	реле
jqx-10ff/120a3znil	реле
jqx-10ff/120nil2zd	реле
jqx-10ff/120nil2znil	реле
jqx-10ff/120nil3z-1d	реле
jqx-10ff/120nil3z-1nil	реле
jqx-10ff/120nil3zd	реле
jqx-10ff/120nil3znil	реле
jqx-10ff/220a2zd	реле
jqx-10ff/220a2znil	реле
jqx-10ff/220a3z-1d	реле
jqx-10ff/220a3z-1nil	реле
jqx-10ff/220a3zd	реле
jqx-10ff/220a3znil	реле
jqx-10ff/220nil2zd	реле
jqx-10ff/220nil2znil	реле
jqx-10ff/220nil3z-1d	реле
jqx-10ff/220nil3z-1nil	реле
jqx-10ff/220nil3zd	реле
jqx-10ff/220nil3znil	реле
jqx-10ff/240a2zd	реле
jqx-10ff/240a2znil	реле
jqx-10ff/240a3z-1d	реле
jqx-10ff/240a3z-1nil	реле

jqx-10ff/240a3zd реле

jqx-10ff/240a3znil реле

jqx-10ff/240nil2zd реле

jqx-10ff/240nil2znil реле

jqx-10ff/240nil3z-1d реле

jqx-10ff/240nil3z-1nil реле

jqx-10ff/240nil3zd реле

jqx-10ff/240nil3znil реле

jqx-115 реле

jqx-115-f-i etc1 [list of unclassified manufacturers], 16a pole board typ

jqx-115f реле

jqx-115f-006-1hs3-551 glenair

jqx-115f-012-1hs3-551 glenair

jqx-115f-012-1hs3a(555) glenair

jqx-115f-012-1z1a 555 glenair

jqx-115f-012-1z3a 555 glenair

jqx-115f-012-1zs1 hongfa, dip 2011

jqx-115f-012-1zs3-551 glenair

jqx-115f-012-1zs3a (555) glenair

jqx-115f-012-1zs3b glenair

jqx-115f-012-2zs4 hongfa, dip 2011

jqx-115f-012-2zs4(551) hongfa electroacoustic co.,ltd., реле средней мощности; ик,а =8; ик,в =250вас; ин,в = 12; р,вт = 0.4; кол. ком. гр. =2; вид конт. группы с; иі/о,в =1000; тэкср, °с -40...+85; тип упр. и дс; вр. сраб.

jqx-115f-024-1z3 glenair

jqx-115f-024-1z3a-555 glenair

jqx-115f-024-1zs1 hongfa, dip 2011

jqx-115f-024-1zs3(551) hongfa electroacoustic co.,ltd., реле средней мощности; ик,а =16; ик,в =250вас; ин,в = 24; р,вт = 0.4; кол. ком. гр. = 1; вид конт. группы с; иі/о,в = 1000; тэкср, °с -40...+85; тип упр. и дс; вр. сраб.

jqx-115f-024-2zs4 glenair

jqx-115f-024-2zs4(551) hongfa electroacoustic co.,ltd., реле средней мощности; ик,а =8; ук,в =250вас; ин,в = 24; р,вт =0.4; кол. ком. гр. =2; вид конт. группы с; uі/о,в =1000; тэкср, °с -40...+85; тип упр. и дс; вр. сраб.

jqx-115f-024-2zs4b glenair

jqx-115f-048-2zs4b-610-555 glenair

jqx-115f-i реле

jqx-115f-i0051hs3a реле

jqx-115f-i0061hs3a реле

jqx-115f-i0091hs3a реле

jqx-115f-i0121hs3a реле

jqx-115f-i0181hs3a реле

jqx-115f-i0241hs3a реле

jqx-115f-i0481hs3a реле

jqx-115f-i0601hs3a реле

jqx-115f-i1101hnil3 etc1 [list of unclassified manufacturers], 16a pole board typ

jqx-115f-i1101hs3 etc1 [list of unclassified manufacturers], 16a pole board typ

jqx-115f-i1101hs3a реле

jqx-115f-i121hnil3 etc1 [list of unclassified manufacturers], 16a pole board typ

jqx-115f-i121hs3 etc1 [list of unclassified manufacturers], 16a pole board typ

jqx-115f-i241hnil3 etc1 [list of unclassified manufacturers], 16a pole board typ

jqx-115f-i241hs3 etc1 [list of unclassified manufacturers], 16a pole board typ

jqx-115f-i481hnil3 etc1 [list of unclassified manufacturers], 16a pole board typ

jqx-115f-i481hs3 etc1 [list of unclassified manufacturers], 16a pole board typ

jqx-115f-i51hnil3 etc1 [list of unclassified manufacturers], 16a pole board typ

jqx-115f-i51hs3 etc1 [list of unclassified manufacturers], 16a pole board typ

jqx-115f-i601hnil3 etc1 [list of unclassified manufacturers], 16a pole board typ

jqx-115f-i601hs3 etc1 [list of unclassified manufacturers], 16a pole board typ

jqx-115f-i61hnil3 etc1 [list of unclassified manufacturers], 16a pole board typ

jqx-115f-i61hs3 etc1 [list of unclassified manufacturers], 16a pole board typ

jqx-115f-t реле

jqx-115f-t-005-1z3-551 glenair

jqx-115f-t0051hnil3a реле

jqx-115f-t0051hnil3b реле

jqx-115f-t0051hnil3nil реле

jqx-115f-t0051hs3a реле

jqx-115f-t0051hs3b реле

jqx-115f-t0051hs3nil реле

jqx-115f-t0051znil3a реле

jqx-115f-t0051znil3b реле

jqx-115f-t0051znil3nil реле

jqx-115f-t0051zs3a реле

jqx-115f-t0051zs3b реле

jqx-115f-t0051zs3nil реле

jqx-115f-t0061hnil3a реле

jqx-115f-t0061hnil3b реле

jqx-115f-t0061hnil3nil реле

jqx-115f-t0061hs3a реле

jqx-115f-t0061hs3b реле

jqx-115f-t0061hs3nil реле

jqx-115f-t0061znil3a реле

jqx-115f-t0061znil3b реле

jqx-115f-t0061znil3nil реле

jqx-115f-t0061zs3a реле

jqx-115f-t0061zs3b реле

jqx-115f-t0061zs3nil реле

jqx-115f-t0091hnil3a реле

jqx-115f-t0091hnil3b реле
jqx-115f-t0091hnil3nil реле
jqx-115f-t0091hs3a реле
jqx-115f-t0091hs3b реле
jqx-115f-t0091hs3nil реле
jqx-115f-t0091znil3a реле
jqx-115f-t0091znil3b реле
jqx-115f-t0091znil3nil реле
jqx-115f-t0091zs3a реле
jqx-115f-t0091zs3b реле
jqx-115f-t0091zs3nil реле
jqx-115f-t0121hnil3a реле
jqx-115f-t0121hnil3b реле
jqx-115f-t0121hnil3nil реле
jqx-115f-t0121hs3a реле
jqx-115f-t0121hs3b реле
jqx-115f-t0121hs3nil реле
jqx-115f-t0121znil3a реле
jqx-115f-t0121znil3b реле
jqx-115f-t0121znil3nil реле
jqx-115f-t0121zs3a реле
jqx-115f-t0121zs3b реле
jqx-115f-t0121zs3nil реле
jqx-115f-t0181hnil3a реле
jqx-115f-t0181hnil3b реле
jqx-115f-t0181hnil3nil реле
jqx-115f-t0181hs3a реле
jqx-115f-t0181hs3b реле

jqx-115f-t0181hs3nil	реле
jqx-115f-t0181znil3a	реле
jqx-115f-t0181znil3b	реле
jqx-115f-t0181znil3nil	реле
jqx-115f-t0181zs3a	реле
jqx-115f-t0181zs3b	реле
jqx-115f-t0181zs3nil	реле
jqx-115f-t0241hnil3a	реле
jqx-115f-t0241hnil3b	реле
jqx-115f-t0241hnil3nil	реле
jqx-115f-t0241hs3a	реле
jqx-115f-t0241hs3b	реле
jqx-115f-t0241hs3nil	реле
jqx-115f-t0241znil3a	реле
jqx-115f-t0241znil3b	реле
jqx-115f-t0241znil3nil	реле
jqx-115f-t0241zs3a	реле
jqx-115f-t0241zs3b	реле
jqx-115f-t0241zs3nil	реле
jqx-115f-t0481hnil3a	реле
jqx-115f-t0481hnil3b	реле
jqx-115f-t0481hnil3nil	реле
jqx-115f-t0481hs3a	реле
jqx-115f-t0481hs3b	реле
jqx-115f-t0481hs3nil	реле
jqx-115f-t0481znil3a	реле
jqx-115f-t0481znil3b	реле
jqx-115f-t0481znil3nil	реле

jqx-115f-t0481zs3a реле
jqx-115f-t0481zs3b реле
jqx-115f-t0481zs3nil реле
jqx-115f-t0601hnil3a реле
jqx-115f-t0601hnil3b реле
jqx-115f-t0601hnil3nil реле
jqx-115f-t0601hs3a реле
jqx-115f-t0601hs3b реле
jqx-115f-t0601hs3nil реле
jqx-115f-t0601znil3a реле
jqx-115f-t0601znil3b реле
jqx-115f-t0601znil3nil реле
jqx-115f-t0601zs3a реле
jqx-115f-t0601zs3b реле
jqx-115f-t0601zs3nil реле
jqx-115f-th реле
jqx-115f-th0051hnil3a реле
jqx-115f-th0051hnil3b реле
jqx-115f-th0051hnil3nil реле
jqx-115f-th0051hs3a реле
jqx-115f-th0051hs3b реле
jqx-115f-th0051hs3nil реле
jqx-115f-th0051znil3a реле
jqx-115f-th0051znil3b реле
jqx-115f-th0051znil3nil реле
jqx-115f-th0051zs3a реле
jqx-115f-th0051zs3b реле
jqx-115f-th0051zs3nil реле

jqx-115f-th0061hnil3a реле
jqx-115f-th0061hnil3b реле
jqx-115f-th0061hnil3nil реле
jqx-115f-th0061hs3a реле
jqx-115f-th0061hs3b реле
jqx-115f-th0061hs3nil реле
jqx-115f-th0061znil3a реле
jqx-115f-th0061znil3b реле
jqx-115f-th0061znil3nil реле
jqx-115f-th0061zs3a реле
jqx-115f-th0061zs3b реле
jqx-115f-th0061zs3nil реле
jqx-115f-th0091hnil3a реле
jqx-115f-th0091hnil3b реле
jqx-115f-th0091hnil3nil реле
jqx-115f-th0091hs3a реле
jqx-115f-th0091hs3b реле
jqx-115f-th0091hs3nil реле
jqx-115f-th0091znil3a реле
jqx-115f-th0091znil3b реле
jqx-115f-th0091znil3nil реле
jqx-115f-th0091zs3a реле
jqx-115f-th0091zs3b реле
jqx-115f-th0091zs3nil реле
jqx-115f-th0121hnil3a реле
jqx-115f-th0121hnil3b реле
jqx-115f-th0121hnil3nil реле
jqx-115f-th0121hs3a реле

jqx-115f-th0121hs3b реле
jqx-115f-th0121hs3nil реле
jqx-115f-th0121znil3a реле
jqx-115f-th0121znil3b реле
jqx-115f-th0121znil3nil реле
jqx-115f-th0121zs3a реле
jqx-115f-th0121zs3b реле
jqx-115f-th0121zs3nil реле
jqx-115f-th0181hnil3a реле
jqx-115f-th0181hnil3b реле
jqx-115f-th0181hnil3nil реле
jqx-115f-th0181hs3a реле
jqx-115f-th0181hs3b реле
jqx-115f-th0181hs3nil реле
jqx-115f-th0181znil3a реле
jqx-115f-th0181znil3b реле
jqx-115f-th0181znil3nil реле
jqx-115f-th0181zs3a реле
jqx-115f-th0181zs3b реле
jqx-115f-th0181zs3nil реле
jqx-115f-th0241hnil3a реле
jqx-115f-th0241hnil3b реле
jqx-115f-th0241hnil3nil реле
jqx-115f-th0241hs3a реле
jqx-115f-th0241hs3b реле
jqx-115f-th0241hs3nil реле
jqx-115f-th0241znil3a реле
jqx-115f-th0241znil3b реле

jqx-115f-th0241znil3nil реле
jqx-115f-th0241zs3a реле
jqx-115f-th0241zs3b реле
jqx-115f-th0241zs3nil реле
jqx-115f-th0481hnil3a реле
jqx-115f-th0481hnil3b реле
jqx-115f-th0481hnil3nil реле
jqx-115f-th0481hs3a реле
jqx-115f-th0481hs3b реле
jqx-115f-th0481hs3nil реле
jqx-115f-th0481znil3a реле
jqx-115f-th0481znil3b реле
jqx-115f-th0481znil3nil реле
jqx-115f-th0481zs3a реле
jqx-115f-th0481zs3b реле
jqx-115f-th0481zs3nil реле
jqx-115f-th0601hnil3a реле
jqx-115f-th0601hnil3b реле
jqx-115f-th0601hnil3nil реле
jqx-115f-th0601hs3a реле
jqx-115f-th0601hs3b реле
jqx-115f-th0601hs3nil реле
jqx-115f-th0601znil3a реле
jqx-115f-th0601znil3b реле
jqx-115f-th0601znil3nil реле
jqx-115f-th0601zs3a реле
jqx-115f-th0601zs3b реле
jqx-115f-th0601zs3nil реле

jqx-115f/012-1zs3 (551) hongfa electroacoustic co.,ltd., реле средней мощности; $i_{к,а} = 16$; $u_{к,в} = 250$ vac; $u_{н,в} = 12$; $p_{в,т} = 0.4$; кол. ком. гр. = 1; вид конт. группы с; $u_{i/o,в} = 1000$; тэкср, °с -40...+85; тип упр. и дс; вр. сраб.

jqx-115f/0121ds1 реле

jqx-115f/0121ds2.3 реле

jqx-115f/0121ds4 реле

jqx-115f/0121hs1 реле

jqx-115f/0121hs2.3 реле

jqx-115f/0121hs4 реле

jqx-115f/0121zs1 реле

jqx-115f/0121zs2.3 реле

jqx-115f/0121zs4 реле

jqx-115f/0122ds1 реле

jqx-115f/0122ds2.3 реле

jqx-115f/0122ds4 реле

jqx-115f/0122hs1 реле

jqx-115f/0122hs2.3 реле

jqx-115f/0122hs4 реле

jqx-115f/0122zs1 реле

jqx-115f/0122zs2.3 реле

jqx-115f/0122zs4 реле

jqx-115f/1101ds1 реле

jqx-115f/1101ds2.3 реле

jqx-115f/1101ds4 реле

jqx-115f/1101hs1 реле

jqx-115f/1101hs2.3 реле

jqx-115f/1101hs4 реле

jqx-115f/1101zs1 реле

jqx-115f/1101zs2.3 реле

jqx-115f/1101zs4	реле
jqx-115f/1102ds1	реле
jqx-115f/1102ds2.3	реле
jqx-115f/1102ds4	реле
jqx-115f/1102hs1	реле
jqx-115f/1102hs2.3	реле
jqx-115f/1102hs4	реле
jqx-115f/1102zs1	реле
jqx-115f/1102zs2.3	реле
jqx-115f/1102zs4	реле
jqx-115f/121ds1	реле
jqx-115f/121ds2.3	реле
jqx-115f/121ds4	реле
jqx-115f/121hs1	реле
jqx-115f/121hs2.3	реле
jqx-115f/121hs4	реле
jqx-115f/121zs1	реле
jqx-115f/121zs2.3	реле
jqx-115f/121zs4	реле
jqx-115f/122ds1	реле
jqx-115f/122ds2.3	реле
jqx-115f/122ds4	реле
jqx-115f/122hs1	реле
jqx-115f/122hs2.3	реле
jqx-115f/122hs4	реле
jqx-115f/122zs1	реле
jqx-115f/122zs2.3	реле
jqx-115f/122zs4	реле

jqx-115f/241ds1	реле
jqx-115f/241ds2.3	реле
jqx-115f/241ds4	реле
jqx-115f/241hs1	реле
jqx-115f/241hs2.3	реле
jqx-115f/241hs4	реле
jqx-115f/241zs1	реле
jqx-115f/241zs2.3	реле
jqx-115f/241zs4	реле
jqx-115f/242ds1	реле
jqx-115f/242ds2.3	реле
jqx-115f/242ds4	реле
jqx-115f/242hs1	реле
jqx-115f/242hs2.3	реле
jqx-115f/242hs4	реле
jqx-115f/242zs1	реле
jqx-115f/242zs2.3	реле
jqx-115f/242zs4	реле
jqx-115f/481ds1	реле
jqx-115f/481ds2.3	реле
jqx-115f/481ds4	реле
jqx-115f/481hs1	реле
jqx-115f/481hs2.3	реле
jqx-115f/481hs4	реле
jqx-115f/481zs1	реле
jqx-115f/481zs2.3	реле
jqx-115f/481zs4	реле
jqx-115f/482ds1	реле

jqx-115f/482ds2.3	реле
jqx-115f/482ds4	реле
jqx-115f/482hs1	реле
jqx-115f/482hs2.3	реле
jqx-115f/482hs4	реле
jqx-115f/482zs1	реле
jqx-115f/482zs2.3	реле
jqx-115f/482zs4	реле
jqx-115f/51ds1	реле
jqx-115f/51ds2.3	реле
jqx-115f/51ds4	реле
jqx-115f/51hs1	реле
jqx-115f/51hs2.3	реле
jqx-115f/51hs4	реле
jqx-115f/51zs1	реле
jqx-115f/51zs2.3	реле
jqx-115f/51zs4	реле
jqx-115f/52ds1	реле
jqx-115f/52ds2.3	реле
jqx-115f/52ds4	реле
jqx-115f/52hs1	реле
jqx-115f/52hs2.3	реле
jqx-115f/52hs4	реле
jqx-115f/52zs1	реле
jqx-115f/52zs2.3	реле
jqx-115f/52zs4	реле
jqx-115f/601ds1	реле
jqx-115f/601ds2.3	реле

jqx-115f/601ds4	реле
jqx-115f/601hs1	реле
jqx-115f/601hs2.3	реле
jqx-115f/601hs4	реле
jqx-115f/601zs1	реле
jqx-115f/601zs2.3	реле
jqx-115f/601zs4	реле
jqx-115f/602ds1	реле
jqx-115f/602ds2.3	реле
jqx-115f/602ds4	реле
jqx-115f/602hs1	реле
jqx-115f/602hs2.3	реле
jqx-115f/602hs4	реле
jqx-115f/602zs1	реле
jqx-115f/602zs2.3	реле
jqx-115f/602zs4	реле
jqx-115f/61ds1	реле
jqx-115f/61ds2.3	реле
jqx-115f/61ds4	реле
jqx-115f/61hs1	реле
jqx-115f/61hs2.3	реле
jqx-115f/61hs4	реле
jqx-115f/61zs1	реле
jqx-115f/61zs2.3	реле
jqx-115f/61zs4	реле
jqx-115f/62ds1	реле
jqx-115f/62ds2.3	реле
jqx-115f/62ds4	реле

jqx-115f/62hs1 реле
jqx-115f/62hs2.3 реле
jqx-115f/62hs4 реле
jqx-115f/62zs1 реле
jqx-115f/62zs2.3 реле
jqx-115f/62zs4 реле
jqx-115f012-1zs2
jqx-116f-1 реле
jqx-116f-1/асаа1h реле
jqx-116f-1/асаа2h реле
jqx-116f-1/асаf1h реле
jqx-116f-1/асаf2h реле
jqx-116f-1/асаp1h реле
jqx-116f-1/асаp2h реле
jqx-116f-1/асda1h реле
jqx-116f-1/асda2h реле
jqx-116f-1/асdf1h реле
jqx-116f-1/асdf2h реле
jqx-116f-1/асdp1h реле
jqx-116f-1/асdp2h реле
jqx-116f-1/дсаа1h реле
jqx-116f-1/дсаа2h реле
jqx-116f-1/дсаf1h реле
jqx-116f-1/дсаf2h реле
jqx-116f-1/дсаp1h реле
jqx-116f-1/дсаp2h реле
jqx-116f-1/дсda1h реле
jqx-116f-1/дсda2h реле

jqx-116f-1/dcdf1h	реле
jqx-116f-1/dcdf2h	реле
jqx-116f-1/dcdp1h	реле
jqx-116f-1/dcdp2h	реле
jqx-116f-2	реле
jqx-116f-2/018a1hniltfw	реле
jqx-116f-2/018a1hsnilfw	реле
jqx-116f-2/018a1hstfw	реле
jqx-116f-2/018a2hniltfw	реле
jqx-116f-2/018a2hsnilfw	реле
jqx-116f-2/018a2hstfw	реле
jqx-116f-2/018ap1hniltfw	реле
jqx-116f-2/018ap1hsnilfw	реле
jqx-116f-2/018ap1hstfw	реле
jqx-116f-2/018ap2hniltfw	реле
jqx-116f-2/018ap2hsnilfw	реле
jqx-116f-2/018ap2hstfw	реле
jqx-116f-2/018dl1hniltfw	реле
jqx-116f-2/018dl1hsnilfw	реле
jqx-116f-2/018dl1hstfw	реле
jqx-116f-2/018dl2hniltfw	реле
jqx-116f-2/018dl2hsnilfw	реле
jqx-116f-2/018dl2hstfw	реле
jqx-116f-2/018dp1hniltfw	реле
jqx-116f-2/018dp1hsnilfw	реле
jqx-116f-2/018dp1hstfw	реле
jqx-116f-2/018dp2hniltfw	реле

jqx-116f-2/018dp2hsnilfw	реле
jqx-116f-2/018dp2hstfw	реле
jqx-116f-3	реле
jqx-116f-3/003aa1hnilfw	реле
jqx-116f-3/003aa1hnilnilw	реле
jqx-116f-3/003aa1htfw	реле
jqx-116f-3/003aa1htnilw	реле
jqx-116f-3/003aa2hnilfw	реле
jqx-116f-3/003aa2hnilnilw	реле
jqx-116f-3/003aa2htfw	реле
jqx-116f-3/003aa2htnilw	реле
jqx-116f-3/003af1hnilfw	реле
jqx-116f-3/003af1hnilnilw	реле
jqx-116f-3/003af1htfw	реле
jqx-116f-3/003af1htnilw	реле
jqx-116f-3/003af2hnilfw	реле
jqx-116f-3/003af2hnilnilw	реле
jqx-116f-3/003af2htfw	реле
jqx-116f-3/003af2htnilw	реле
jqx-116f-3/003da1hnilfw	реле
jqx-116f-3/003da1hnilnilw	реле
jqx-116f-3/003da1htfw	реле
jqx-116f-3/003da1htnilw	реле
jqx-116f-3/003da2hnilfw	реле
jqx-116f-3/003da2hnilnilw	реле
jqx-116f-3/003da2htfw	реле
jqx-116f-3/003da2htnilw	реле
jqx-116f-3/003df1hnilfw	реле

jqx-116f-3/003df1hnilnilw	реле
jqx-116f-3/003df1htfw	реле
jqx-116f-3/003df1htnilw	реле
jqx-116f-3/003df2hnilfw	реле
jqx-116f-3/003df2hnilnilw	реле
jqx-116f-3/003df2htfw	реле
jqx-116f-3/003df2htnilw	реле
jqx-116f-3/006aa1hnilfw	реле
jqx-116f-3/006aa1hnilnilw	реле
jqx-116f-3/006aa1htfw	реле
jqx-116f-3/006aa1htnilw	реле
jqx-116f-3/006aa2hnilfw	реле
jqx-116f-3/006aa2hnilnilw	реле
jqx-116f-3/006aa2htfw	реле
jqx-116f-3/006aa2htnilw	реле
jqx-116f-3/006af1hnilfw	реле
jqx-116f-3/006af1hnilnilw	реле
jqx-116f-3/006af1htfw	реле
jqx-116f-3/006af1htnilw	реле
jqx-116f-3/006af2hnilfw	реле
jqx-116f-3/006af2hnilnilw	реле
jqx-116f-3/006af2htfw	реле
jqx-116f-3/006af2htnilw	реле
jqx-116f-3/006da1hnilfw	реле
jqx-116f-3/006da1hnilnilw	реле
jqx-116f-3/006da1htfw	реле
jqx-116f-3/006da1htnilw	реле
jqx-116f-3/006da2hnilfw	реле

jqx-116f-3/006da2hnilnilw	реле
jqx-116f-3/006da2htfw	реле
jqx-116f-3/006da2htnilw	реле
jqx-116f-3/006df1hnilfw	реле
jqx-116f-3/006df1hnilnilw	реле
jqx-116f-3/006df1htfw	реле
jqx-116f-3/006df1htnilw	реле
jqx-116f-3/006df2hnilfw	реле
jqx-116f-3/006df2hnilnilw	реле
jqx-116f-3/006df2htfw	реле
jqx-116f-3/006df2htnilw	реле
jqx-116f-3/018aa1hnilfw	реле
jqx-116f-3/018aa1hnilnilw	реле
jqx-116f-3/018aa1htfw	реле
jqx-116f-3/018aa1htnilw	реле
jqx-116f-3/018aa2hnilfw	реле
jqx-116f-3/018aa2hnilnilw	реле
jqx-116f-3/018aa2htfw	реле
jqx-116f-3/018aa2htnilw	реле
jqx-116f-3/018af1hnilfw	реле
jqx-116f-3/018af1hnilnilw	реле
jqx-116f-3/018af1htfw	реле
jqx-116f-3/018af1htnilw	реле
jqx-116f-3/018af2hnilfw	реле
jqx-116f-3/018af2hnilnilw	реле
jqx-116f-3/018af2htfw	реле
jqx-116f-3/018af2htnilw	реле
jqx-116f-3/018da1hnilfw	реле

jqx-116f-3/018da1hnilnilw	реле
jqx-116f-3/018da1htfw	реле
jqx-116f-3/018da1htnilw	реле
jqx-116f-3/018da2hnilfw	реле
jqx-116f-3/018da2hnilnilw	реле
jqx-116f-3/018da2htfw	реле
jqx-116f-3/018da2htnilw	реле
jqx-116f-3/018df1hnilfw	реле
jqx-116f-3/018df1hnilnilw	реле
jqx-116f-3/018df1htfw	реле
jqx-116f-3/018df1htnilw	реле
jqx-116f-3/018df2hnilfw	реле
jqx-116f-3/018df2hnilnilw	реле
jqx-116f-3/018df2htfw	реле
jqx-116f-3/018df2htnilw	реле
jqx-116f-3/200aa1hnilfw	реле
jqx-116f-3/200aa1hnilnilw	реле
jqx-116f-3/200aa1htfw	реле
jqx-116f-3/200aa1htnilw	реле
jqx-116f-3/200aa2hnilfw	реле
jqx-116f-3/200aa2hnilnilw	реле
jqx-116f-3/200aa2htfw	реле
jqx-116f-3/200aa2htnilw	реле
jqx-116f-3/200af1hnilfw	реле
jqx-116f-3/200af1hnilnilw	реле
jqx-116f-3/200af1htfw	реле
jqx-116f-3/200af1htnilw	реле
jqx-116f-3/200af2hnilfw	реле

jqx-116f-3/200af2hnilnilw	реле
jqx-116f-3/200af2htfw	реле
jqx-116f-3/200af2htnilw	реле
jqx-116f-3/200da1hnilfw	реле
jqx-116f-3/200da1hnilnilw	реле
jqx-116f-3/200da1htfw	реле
jqx-116f-3/200da1htnilw	реле
jqx-116f-3/200da2hnilfw	реле
jqx-116f-3/200da2hnilnilw	реле
jqx-116f-3/200da2htfw	реле
jqx-116f-3/200da2htnilw	реле
jqx-116f-3/200df1hnilfw	реле
jqx-116f-3/200df1hnilnilw	реле
jqx-116f-3/200df1htfw	реле
jqx-116f-3/200df1htnilw	реле
jqx-116f-3/200df2hnilfw	реле
jqx-116f-3/200df2hnilnilw	реле
jqx-116f-3/200df2htfw	реле
jqx-116f-3/200df2htnilw	реле
jqx-116f-3/240aa1hnilfw	реле
jqx-116f-3/240aa1hnilnilw	реле
jqx-116f-3/240aa1htfw	реле
jqx-116f-3/240aa1htnilw	реле
jqx-116f-3/240aa2hnilfw	реле
jqx-116f-3/240aa2hnilnilw	реле
jqx-116f-3/240aa2htfw	реле
jqx-116f-3/240aa2htnilw	реле
jqx-116f-3/240af1hnilfw	реле

jqx-116f-3/240af1hnilnilw реле

jqx-116f-3/240af1htfw реле

jqx-116f-3/240af1htnilw реле

jqx-116f-3/240af2hnilfw реле

jqx-116f-3/240af2hnilnilw реле

jqx-116f-3/240af2htfw реле

jqx-116f-3/240af2htnilw реле

jqx-116f-3/240da1hnilfw реле

jqx-116f-3/240da1hnilnilw реле

jqx-116f-3/240da1htfw реле

jqx-116f-3/240da1htnilw реле

jqx-116f-3/240da2hnilfw реле

jqx-116f-3/240da2hnilnilw реле

jqx-116f-3/240da2htfw реле

jqx-116f-3/240da2htnilw реле

jqx-116f-3/240df1hnilfw реле

jqx-116f-3/240df1hnilnilw реле

jqx-116f-3/240df1htfw реле

jqx-116f-3/240df1htnilw реле

jqx-116f-3/240df2hnilfw реле

jqx-116f-3/240df2hnilnilw реле

jqx-116f-3/240df2htfw реле

jqx-116f-3/240df2htnilw реле

jqx-118f-024-1zs1t-555 glenair

jqx-13f huaxinan [huaxinan electronics co.,ltd], small size, light weight, heavy reverse power

jqx-13f-24vac

jqx-13f-24vdc

jqx-13f/1202z1 etc2 [list of unclassified manufacturers], miniature intermediate power rela

jqx-13f/1202z1d etc2 [list of unclassified manufacturers], miniature intermediate power rela
jqx-13f/1202z2 etc2 [list of unclassified manufacturers], miniature intermediate power rela
jqx-13f/1202z2d etc2 [list of unclassified manufacturers], miniature intermediate power rela
jqx-13f/1202z3 etc2 [list of unclassified manufacturers], miniature intermediate power rela
jqx-13f/1202z3d etc2 [list of unclassified manufacturers], miniature intermediate power rela
jqx-13f/1202z4 etc2 [list of unclassified manufacturers], miniature intermediate power rela
jqx-13f/1202z4d etc2 [list of unclassified manufacturers], miniature intermediate power rela
jqx-13f/1202z5 etc2 [list of unclassified manufacturers], miniature intermediate power rela
jqx-13f/1202z5d etc2 [list of unclassified manufacturers], miniature intermediate power rela
jqx-13f/2201z1 etc2 [list of unclassified manufacturers], miniature intermediate power rela
jqx-13f/2201z1d etc2 [list of unclassified manufacturers], miniature intermediate power rela
jqx-13f/2201z2 etc2 [list of unclassified manufacturers], miniature intermediate power rela
jqx-13f/2201z2d etc2 [list of unclassified manufacturers], miniature intermediate power rela
jqx-13f/2201z3 etc2 [list of unclassified manufacturers], miniature intermediate power rela
jqx-13f/2201z3d etc2 [list of unclassified manufacturers], miniature intermediate power rela
jqx-13f/2201z4 etc2 [list of unclassified manufacturers], miniature intermediate power rela
jqx-13f/2201z4d etc2 [list of unclassified manufacturers], miniature intermediate power rela
jqx-13f/2201z5 etc2 [list of unclassified manufacturers], miniature intermediate power rela
jqx-13f/2201z5d etc2 [list of unclassified manufacturers], miniature intermediate power rela
jqx-13f/2202z1 etc2 [list of unclassified manufacturers], miniature intermediate power rela
jqx-13f/2202z1d etc2 [list of unclassified manufacturers], miniature intermediate power rela
jqx-13f/2202z2 etc2 [list of unclassified manufacturers], miniature intermediate power rela
jqx-13f/2202z2d etc2 [list of unclassified manufacturers], miniature intermediate power rela
jqx-13f/2202z3 etc2 [list of unclassified manufacturers], miniature intermediate power rela
jqx-13f/2202z3d etc2 [list of unclassified manufacturers], miniature intermediate power rela
jqx-13f/2202z4 etc2 [list of unclassified manufacturers], miniature intermediate power rela
jqx-13f/2202z4d etc2 [list of unclassified manufacturers], miniature intermediate power rela
jqx-13f/2202z5 etc2 [list of unclassified manufacturers], miniature intermediate power rela

jqx-13f/2202z5d etc2 [list of unclassified manufacturers], miniature intermediate power rela

jqx-13f/2402z1 etc2 [list of unclassified manufacturers], miniature intermediate power rela

jqx-13f/2402z1d etc2 [list of unclassified manufacturers], miniature intermediate power rela

jqx-13f/2402z2 etc2 [list of unclassified manufacturers], miniature intermediate power rela

jqx-13f/2402z2d etc2 [list of unclassified manufacturers], miniature intermediate power rela

jqx-13f/2402z3 etc2 [list of unclassified manufacturers], miniature intermediate power rela

jqx-13f/2402z3d etc2 [list of unclassified manufacturers], miniature intermediate power rela

jqx-13f/2402z4 etc2 [list of unclassified manufacturers], miniature intermediate power rela

jqx-13f/2402z4d etc2 [list of unclassified manufacturers], miniature intermediate power rela

jqx-13f/2402z5 etc2 [list of unclassified manufacturers], miniature intermediate power rela

jqx-13f/2402z5d etc2 [list of unclassified manufacturers], miniature intermediate power rela

jqx-13f/a0122z1d016 etc2 [list of unclassified manufacturers], miniature intermediate power rela

jqx-13f/a0281z1 etc2 [list of unclassified manufacturers], miniature intermediate power rela

jqx-13f/a0281z1d etc2 [list of unclassified manufacturers], miniature intermediate power rela

jqx-13f/a0281z2 etc2 [list of unclassified manufacturers], miniature intermediate power rela

jqx-13f/a0281z2d etc2 [list of unclassified manufacturers], miniature intermediate power rela

jqx-13f/a0281z3 etc2 [list of unclassified manufacturers], miniature intermediate power rela

jqx-13f/a0281z3d etc2 [list of unclassified manufacturers], miniature intermediate power rela

jqx-13f/a0281z4 etc2 [list of unclassified manufacturers], miniature intermediate power rela

jqx-13f/a0281z4d etc2 [list of unclassified manufacturers], miniature intermediate power rela

jqx-13f/a0281z5 etc2 [list of unclassified manufacturers], miniature intermediate power rela

jqx-13f/a0281z5d etc2 [list of unclassified manufacturers], miniature intermediate power rela

jqx-13f/a0282z1 etc2 [list of unclassified manufacturers], miniature intermediate power rela

jqx-13f/a0282z1d etc2 [list of unclassified manufacturers], miniature intermediate power rela

jqx-13f/a0282z2 etc2 [list of unclassified manufacturers], miniature intermediate power rela

jqx-13f/a0282z2d etc2 [list of unclassified manufacturers], miniature intermediate power rela

jqx-13f/a0282z3 etc2 [list of unclassified manufacturers], miniature intermediate power rela

jqx-13f/a0282z3d etc2 [list of unclassified manufacturers], miniature intermediate power rela

jqx-13f/a0282z4	etc2 [list of unclassified manufacturers], miniature intermediate power rela
jqx-13f/a0282z4d	etc2 [list of unclassified manufacturers], miniature intermediate power rela
jqx-13f/a0282z5	etc2 [list of unclassified manufacturers], miniature intermediate power rela
jqx-13f/a0282z5d	etc2 [list of unclassified manufacturers], miniature intermediate power rela
jqx-13f/a0301z1	etc2 [list of unclassified manufacturers], miniature intermediate power rela
jqx-13f/a0301z1d	etc2 [list of unclassified manufacturers], miniature intermediate power rela
jqx-13f/a0301z2	etc2 [list of unclassified manufacturers], miniature intermediate power rela
jqx-13f/a0301z2d	etc2 [list of unclassified manufacturers], miniature intermediate power rela
jqx-13f/a0301z3	etc2 [list of unclassified manufacturers], miniature intermediate power rela
jqx-13f/a0301z3d	etc2 [list of unclassified manufacturers], miniature intermediate power rela
jqx-13f/a0301z4	etc2 [list of unclassified manufacturers], miniature intermediate power rela
jqx-13f/a0301z4d	etc2 [list of unclassified manufacturers], miniature intermediate power rela
jqx-13f/a0301z5	etc2 [list of unclassified manufacturers], miniature intermediate power rela
jqx-13f/a0301z5d	etc2 [list of unclassified manufacturers], miniature intermediate power rela
jqx-13f/a0302z1	etc2 [list of unclassified manufacturers], miniature intermediate power rela
jqx-13f/a0302z1d	etc2 [list of unclassified manufacturers], miniature intermediate power rela
jqx-13f/a0302z2	etc2 [list of unclassified manufacturers], miniature intermediate power rela
jqx-13f/a0302z2d	etc2 [list of unclassified manufacturers], miniature intermediate power rela
jqx-13f/a0302z3	etc2 [list of unclassified manufacturers], miniature intermediate power rela
jqx-13f/a0302z3d	etc2 [list of unclassified manufacturers], miniature intermediate power rela
jqx-13f/a0302z4	etc2 [list of unclassified manufacturers], miniature intermediate power rela
jqx-13f/a0302z4d	etc2 [list of unclassified manufacturers], miniature intermediate power rela
jqx-13f/a0302z5	etc2 [list of unclassified manufacturers], miniature intermediate power rela
jqx-13f/a0302z5d	etc2 [list of unclassified manufacturers], miniature intermediate power rela
jqx-13f1a	huaxinan [huaxinan electronics co.,ltd], small size, light weight, heavy reverse power
jqx-13f1aac110v1d	реле
jqx-13f1aac110v1l	реле
jqx-13f1aac110v1ld	реле

jqx-13f1aaac110v1nil	реле
jqx-13f1aaac110v2d	реле
jqx-13f1aaac110v2l	реле
jqx-13f1aaac110v2ld	реле
jqx-13f1aaac110v2nil	реле
jqx-13f1aaac12v1d	реле
jqx-13f1aaac12v1l	реле
jqx-13f1aaac12v1ld	реле
jqx-13f1aaac12v1nil	реле
jqx-13f1aaac12v2d	реле
jqx-13f1aaac12v2l	реле
jqx-13f1aaac12v2ld	реле
jqx-13f1aaac12v2nil	реле
jqx-13f1aaac24v1d	реле
jqx-13f1aaac24v1l	реле
jqx-13f1aaac24v1ld	реле
jqx-13f1aaac24v1nil	реле
jqx-13f1aaac24v2d	реле
jqx-13f1aaac24v2l	реле
jqx-13f1aaac24v2ld	реле
jqx-13f1aaac24v2nil	реле
jqx-13f1aaac36v1d	реле
jqx-13f1aaac36v1l	реле
jqx-13f1aaac36v1ld	реле
jqx-13f1aaac36v1nil	реле
jqx-13f1aaac36v2d	реле
jqx-13f1aaac36v2l	реле
jqx-13f1aaac36v2ld	реле

jqx-13f1aaac36v2nil	реле
jqx-13f1aaac48v1d	реле
jqx-13f1aaac48v1l	реле
jqx-13f1aaac48v1ld	реле
jqx-13f1aaac48v1nil	реле
jqx-13f1aaac48v2d	реле
jqx-13f1aaac48v2l	реле
jqx-13f1aaac48v2ld	реле
jqx-13f1aaac48v2nil	реле
jqx-13f1aadc110v1	ningbo forward relay corporation
jqx-13f1aadc110v1d	реле
jqx-13f1aadc110v1l	реле
jqx-13f1aadc110v1ld	реле
jqx-13f1aadc110v1nil	реле
jqx-13f1aadc110v2d	реле
jqx-13f1aadc110v2l	реле
jqx-13f1aadc110v2ld	реле
jqx-13f1aadc110v2nil	реле
jqx-13f1aadc12v1d	реле
jqx-13f1aadc12v1l	реле
jqx-13f1aadc12v1ld	реле
jqx-13f1aadc12v1nil	реле
jqx-13f1aadc12v2d	реле
jqx-13f1aadc12v2l	реле
jqx-13f1aadc12v2ld	реле
jqx-13f1aadc12v2nil	реле
jqx-13f1aadc24v1d	реле
jqx-13f1aadc24v1l	реле

jqx-13f1aacdc24v1d	реле
jqx-13f1aacdc24v1nil	реле
jqx-13f1aacdc24v2d	реле
jqx-13f1aacdc24v2l	реле
jqx-13f1aacdc24v2ld	реле
jqx-13f1aacdc24v2nil	реле
jqx-13f1aacdc36v1d	реле
jqx-13f1aacdc36v1l	реле
jqx-13f1aacdc36v1ld	реле
jqx-13f1aacdc36v1nil	реле
jqx-13f1aacdc36v2d	реле
jqx-13f1aacdc36v2l	реле
jqx-13f1aacdc36v2ld	реле
jqx-13f1aacdc36v2nil	реле
jqx-13f1aacdc48v1d	реле
jqx-13f1aacdc48v1l	реле
jqx-13f1aacdc48v1ld	реле
jqx-13f1aacdc48v1nil	реле
jqx-13f1aacdc48v2d	реле
jqx-13f1aacdc48v2l	реле
jqx-13f1aacdc48v2ld	реле
jqx-13f1aacdc48v2nil	реле
jqx-13f1abac110v1d	реле
jqx-13f1abac110v1l	реле
jqx-13f1abac110v1ld	реле
jqx-13f1abac110v1nil	реле
jqx-13f1abac110v2d	реле
jqx-13f1abac110v2l	реле

jqx-13f1abac110v2ld	реле
jqx-13f1abac110v2nil	реле
jqx-13f1abac12v1d	реле
jqx-13f1abac12v1l	реле
jqx-13f1abac12v1ld	реле
jqx-13f1abac12v1nil	реле
jqx-13f1abac12v2d	реле
jqx-13f1abac12v2l	реле
jqx-13f1abac12v2ld	реле
jqx-13f1abac12v2nil	реле
jqx-13f1abac24v1d	реле
jqx-13f1abac24v1l	реле
jqx-13f1abac24v1ld	реле
jqx-13f1abac24v1nil	реле
jqx-13f1abac24v2d	реле
jqx-13f1abac24v2l	реле
jqx-13f1abac24v2ld	реле
jqx-13f1abac24v2nil	реле
jqx-13f1abac36v1d	реле
jqx-13f1abac36v1l	реле
jqx-13f1abac36v1ld	реле
jqx-13f1abac36v1nil	реле
jqx-13f1abac36v2d	реле
jqx-13f1abac36v2l	реле
jqx-13f1abac36v2ld	реле
jqx-13f1abac36v2nil	реле
jqx-13f1abac48v1d	реле
jqx-13f1abac48v1l	реле

jqx-13f1abac48v1d	реле
jqx-13f1abac48v1nil	реле
jqx-13f1abac48v2d	реле
jqx-13f1abac48v2l	реле
jqx-13f1abac48v2ld	реле
jqx-13f1abac48v2nil	реле
jqx-13f1abdc110v1d	реле
jqx-13f1abdc110v1l	реле
jqx-13f1abdc110v1ld	реле
jqx-13f1abdc110v1nil	реле
jqx-13f1abdc110v2d	реле
jqx-13f1abdc110v2l	реле
jqx-13f1abdc110v2ld	реле
jqx-13f1abdc110v2nil	реле
jqx-13f1abdc12v1d	реле
jqx-13f1abdc12v1l	реле
jqx-13f1abdc12v1ld	реле
jqx-13f1abdc12v1nil	реле
jqx-13f1abdc12v2d	реле
jqx-13f1abdc12v2l	реле
jqx-13f1abdc12v2ld	реле
jqx-13f1abdc12v2nil	реле
jqx-13f1abdc24v1d	реле
jqx-13f1abdc24v1l	реле
jqx-13f1abdc24v1ld	реле
jqx-13f1abdc24v1nil	реле
jqx-13f1abdc24v2d	реле
jqx-13f1abdc24v2l	реле

jqx-13f1abdc24v2d	реле
jqx-13f1abdc24v2nil	реле
jqx-13f1abdc36v1d	реле
jqx-13f1abdc36v1l	реле
jqx-13f1abdc36v1d	реле
jqx-13f1abdc36v1nil	реле
jqx-13f1abdc36v2d	реле
jqx-13f1abdc36v2l	реле
jqx-13f1abdc36v2d	реле
jqx-13f1abdc36v2nil	реле
jqx-13f1abdc48v1d	реле
jqx-13f1abdc48v1l	реле
jqx-13f1abdc48v1d	реле
jqx-13f1abdc48v1nil	реле
jqx-13f1abdc48v2d	реле
jqx-13f1abdc48v2l	реле
jqx-13f1abdc48v2d	реле
jqx-13f1abdc48v2nil	реле
jqx-13f1b	huaxinan [huaxinan electronics co.,ltd], small size, light weight, heavy reverse power
jqx-13f1baac110v1d	реле
jqx-13f1baac110v1l	реле
jqx-13f1baac110v1d	реле
jqx-13f1baac110v1nil	реле
jqx-13f1baac110v2d	реле
jqx-13f1baac110v2l	реле
jqx-13f1baac110v2d	реле
jqx-13f1baac110v2nil	реле
jqx-13f1baac12v1d	реле

jqx-13f1baac12v1l	реле
jqx-13f1baac12v1ld	реле
jqx-13f1baac12v1nil	реле
jqx-13f1baac12v2d	реле
jqx-13f1baac12v2l	реле
jqx-13f1baac12v2ld	реле
jqx-13f1baac12v2nil	реле
jqx-13f1baac24v1d	реле
jqx-13f1baac24v1l	реле
jqx-13f1baac24v1ld	реле
jqx-13f1baac24v1nil	реле
jqx-13f1baac24v2d	реле
jqx-13f1baac24v2l	реле
jqx-13f1baac24v2ld	реле
jqx-13f1baac24v2nil	реле
jqx-13f1baac36v1d	реле
jqx-13f1baac36v1l	реле
jqx-13f1baac36v1ld	реле
jqx-13f1baac36v1nil	реле
jqx-13f1baac36v2d	реле
jqx-13f1baac36v2l	реле
jqx-13f1baac36v2ld	реле
jqx-13f1baac36v2nil	реле
jqx-13f1baac48v1d	реле
jqx-13f1baac48v1l	реле
jqx-13f1baac48v1ld	реле
jqx-13f1baac48v1nil	реле
jqx-13f1baac48v2d	реле

jqx-13f1baac48v2l	реле
jqx-13f1baac48v2ld	реле
jqx-13f1baac48v2nil	реле
jqx-13f1badc110v1d	реле
jqx-13f1badc110v1l	реле
jqx-13f1badc110v1ld	реле
jqx-13f1badc110v1nil	реле
jqx-13f1badc110v2d	реле
jqx-13f1badc110v2l	реле
jqx-13f1badc110v2ld	реле
jqx-13f1badc110v2nil	реле
jqx-13f1badc12v1d	реле
jqx-13f1badc12v1l	реле
jqx-13f1badc12v1ld	реле
jqx-13f1badc12v1nil	реле
jqx-13f1badc12v2d	реле
jqx-13f1badc12v2l	реле
jqx-13f1badc12v2ld	реле
jqx-13f1badc12v2nil	реле
jqx-13f1badc24v1d	реле
jqx-13f1badc24v1l	реле
jqx-13f1badc24v1ld	реле
jqx-13f1badc24v1nil	реле
jqx-13f1badc24v2d	реле
jqx-13f1badc24v2l	реле
jqx-13f1badc24v2ld	реле
jqx-13f1badc24v2nil	реле
jqx-13f1badc36v1d	реле

jqx-13f1badc36v1l	реле
jqx-13f1badc36v1ld	реле
jqx-13f1badc36v1nil	реле
jqx-13f1badc36v2d	реле
jqx-13f1badc36v2l	реле
jqx-13f1badc36v2ld	реле
jqx-13f1badc36v2nil	реле
jqx-13f1badc48v1d	реле
jqx-13f1badc48v1l	реле
jqx-13f1badc48v1ld	реле
jqx-13f1badc48v1nil	реле
jqx-13f1badc48v2d	реле
jqx-13f1badc48v2l	реле
jqx-13f1badc48v2ld	реле
jqx-13f1badc48v2nil	реле
jqx-13f1bbac110v1d	реле
jqx-13f1bbac110v1l	реле
jqx-13f1bbac110v1ld	реле
jqx-13f1bbac110v1nil	реле
jqx-13f1bbac110v2d	реле
jqx-13f1bbac110v2l	реле
jqx-13f1bbac110v2ld	реле
jqx-13f1bbac110v2nil	реле
jqx-13f1bbac12v1d	реле
jqx-13f1bbac12v1l	реле
jqx-13f1bbac12v1ld	реле
jqx-13f1bbac12v1nil	реле
jqx-13f1bbac12v2d	реле

jqx-13f1bbac12v2l	реле
jqx-13f1bbac12v2ld	реле
jqx-13f1bbac12v2nil	реле
jqx-13f1bbac24v1d	реле
jqx-13f1bbac24v1l	реле
jqx-13f1bbac24v1ld	реле
jqx-13f1bbac24v1nil	реле
jqx-13f1bbac24v2d	реле
jqx-13f1bbac24v2l	реле
jqx-13f1bbac24v2ld	реле
jqx-13f1bbac24v2nil	реле
jqx-13f1bbac36v1d	реле
jqx-13f1bbac36v1l	реле
jqx-13f1bbac36v1ld	реле
jqx-13f1bbac36v1nil	реле
jqx-13f1bbac36v2d	реле
jqx-13f1bbac36v2l	реле
jqx-13f1bbac36v2ld	реле
jqx-13f1bbac36v2nil	реле
jqx-13f1bbac48v1d	реле
jqx-13f1bbac48v1l	реле
jqx-13f1bbac48v1ld	реле
jqx-13f1bbac48v1nil	реле
jqx-13f1bbac48v2d	реле
jqx-13f1bbac48v2l	реле
jqx-13f1bbac48v2ld	реле
jqx-13f1bbac48v2nil	реле
jqx-13f1bbdc110v1d	реле

jqx-13f1bbdc110v1l	реле
jqx-13f1bbdc110v1ld	реле
jqx-13f1bbdc110v1nil	реле
jqx-13f1bbdc110v2d	реле
jqx-13f1bbdc110v2l	реле
jqx-13f1bbdc110v2ld	реле
jqx-13f1bbdc110v2nil	реле
jqx-13f1bbdc12v1d	реле
jqx-13f1bbdc12v1l	реле
jqx-13f1bbdc12v1ld	реле
jqx-13f1bbdc12v1nil	реле
jqx-13f1bbdc12v2d	реле
jqx-13f1bbdc12v2l	реле
jqx-13f1bbdc12v2ld	реле
jqx-13f1bbdc12v2nil	реле
jqx-13f1bbdc24v1d	реле
jqx-13f1bbdc24v1l	реле
jqx-13f1bbdc24v1ld	реле
jqx-13f1bbdc24v1nil	реле
jqx-13f1bbdc24v2d	реле
jqx-13f1bbdc24v2l	реле
jqx-13f1bbdc24v2ld	реле
jqx-13f1bbdc24v2nil	реле
jqx-13f1bbdc36v1d	реле
jqx-13f1bbdc36v1l	реле
jqx-13f1bbdc36v1ld	реле
jqx-13f1bbdc36v1nil	реле
jqx-13f1bbdc36v2d	реле

jqx-13f1bbdc36v2l	реле
jqx-13f1bbdc36v2ld	реле
jqx-13f1bbdc36v2nil	реле
jqx-13f1bbdc48v1d	реле
jqx-13f1bbdc48v1l	реле
jqx-13f1bbdc48v1ld	реле
jqx-13f1bbdc48v1nil	реле
jqx-13f1bbdc48v2d	реле
jqx-13f1bbdc48v2l	реле
jqx-13f1bbdc48v2ld	реле
jqx-13f1bbdc48v2nil	реле
jqx-13f1c	huaxinan [huaxinan electronics co.,ltd], small size, light weight, heavy reverse power
jqx-13f1caac110v1d	реле
jqx-13f1caac110v1l	реле
jqx-13f1caac110v1ld	реле
jqx-13f1caac110v1nil	реле
jqx-13f1caac110v2d	реле
jqx-13f1caac110v2l	реле
jqx-13f1caac110v2ld	реле
jqx-13f1caac110v2nil	реле
jqx-13f1caac12v1d	реле
jqx-13f1caac12v1l	реле
jqx-13f1caac12v1ld	реле
jqx-13f1caac12v1nil	реле
jqx-13f1caac12v2d	реле
jqx-13f1caac12v2l	реле
jqx-13f1caac12v2ld	реле
jqx-13f1caac12v2nil	реле

jqx-13f1caac24v1d	реле
jqx-13f1caac24v1l	реле
jqx-13f1caac24v1ld	реле
jqx-13f1caac24v1nil	реле
jqx-13f1caac24v2d	реле
jqx-13f1caac24v2l	реле
jqx-13f1caac24v2ld	реле
jqx-13f1caac24v2nil	реле
jqx-13f1caac36v1d	реле
jqx-13f1caac36v1l	реле
jqx-13f1caac36v1ld	реле
jqx-13f1caac36v1nil	реле
jqx-13f1caac36v2d	реле
jqx-13f1caac36v2l	реле
jqx-13f1caac36v2ld	реле
jqx-13f1caac36v2nil	реле
jqx-13f1caac48v1d	реле
jqx-13f1caac48v1l	реле
jqx-13f1caac48v1ld	реле
jqx-13f1caac48v1nil	реле
jqx-13f1caac48v2d	реле
jqx-13f1caac48v2l	реле
jqx-13f1caac48v2ld	реле
jqx-13f1caac48v2nil	реле
jqx-13f1cadc110v1d	реле
jqx-13f1cadc110v1l	реле
jqx-13f1cadc110v1ld	реле
jqx-13f1cadc110v1nil	реле

jqx-13f1cadc110v2d	реле
jqx-13f1cadc110v2l	реле
jqx-13f1cadc110v2ld	реле
jqx-13f1cadc110v2nil	реле
jqx-13f1cadc12v1d	реле
jqx-13f1cadc12v1l	реле
jqx-13f1cadc12v1ld	реле
jqx-13f1cadc12v1nil	реле
jqx-13f1cadc12v2d	реле
jqx-13f1cadc12v2l	реле
jqx-13f1cadc12v2ld	реле
jqx-13f1cadc12v2nil	реле
jqx-13f1cadc24v1d	реле
jqx-13f1cadc24v1l	реле
jqx-13f1cadc24v1ld	реле
jqx-13f1cadc24v1nil	реле
jqx-13f1cadc24v2d	реле
jqx-13f1cadc24v2l	реле
jqx-13f1cadc24v2ld	реле
jqx-13f1cadc24v2nil	реле
jqx-13f1cadc36v1d	реле
jqx-13f1cadc36v1l	реле
jqx-13f1cadc36v1ld	реле
jqx-13f1cadc36v1nil	реле
jqx-13f1cadc36v2d	реле
jqx-13f1cadc36v2l	реле
jqx-13f1cadc36v2ld	реле
jqx-13f1cadc36v2nil	реле

jqx-13f1cadc48v1d	реле
jqx-13f1cadc48v1l	реле
jqx-13f1cadc48v1ld	реле
jqx-13f1cadc48v1nil	реле
jqx-13f1cadc48v2d	реле
jqx-13f1cadc48v2l	реле
jqx-13f1cadc48v2ld	реле
jqx-13f1cadc48v2nil	реле
jqx-13f1cbac110v1d	реле
jqx-13f1cbac110v1l	реле
jqx-13f1cbac110v1ld	реле
jqx-13f1cbac110v1nil	реле
jqx-13f1cbac110v2d	реле
jqx-13f1cbac110v2l	реле
jqx-13f1cbac110v2ld	реле
jqx-13f1cbac110v2nil	реле
jqx-13f1cbac12v1d	реле
jqx-13f1cbac12v1l	реле
jqx-13f1cbac12v1ld	реле
jqx-13f1cbac12v1nil	реле
jqx-13f1cbac12v2d	реле
jqx-13f1cbac12v2l	реле
jqx-13f1cbac12v2ld	реле
jqx-13f1cbac12v2nil	реле
jqx-13f1cbac24v1d	реле
jqx-13f1cbac24v1l	реле
jqx-13f1cbac24v1ld	реле
jqx-13f1cbac24v1nil	реле

jqx-13f1cbac24v2d	реле
jqx-13f1cbac24v2l	реле
jqx-13f1cbac24v2ld	реле
jqx-13f1cbac24v2nil	реле
jqx-13f1cbac36v1d	реле
jqx-13f1cbac36v1l	реле
jqx-13f1cbac36v1ld	реле
jqx-13f1cbac36v1nil	реле
jqx-13f1cbac36v2d	реле
jqx-13f1cbac36v2l	реле
jqx-13f1cbac36v2ld	реле
jqx-13f1cbac36v2nil	реле
jqx-13f1cbac48v1d	реле
jqx-13f1cbac48v1l	реле
jqx-13f1cbac48v1ld	реле
jqx-13f1cbac48v1nil	реле
jqx-13f1cbac48v2d	реле
jqx-13f1cbac48v2l	реле
jqx-13f1cbac48v2ld	реле
jqx-13f1cbac48v2nil	реле
jqx-13f1cbdc110v1d	реле
jqx-13f1cbdc110v1l	реле
jqx-13f1cbdc110v1ld	реле
jqx-13f1cbdc110v1nil	реле
jqx-13f1cbdc110v2d	реле
jqx-13f1cbdc110v2l	реле
jqx-13f1cbdc110v2ld	реле
jqx-13f1cbdc110v2nil	реле

jqx-13f1cbdc12v1d	реле
jqx-13f1cbdc12v1l	реле
jqx-13f1cbdc12v1ld	реле
jqx-13f1cbdc12v1nil	реле
jqx-13f1cbdc12v2d	реле
jqx-13f1cbdc12v2l	реле
jqx-13f1cbdc12v2ld	реле
jqx-13f1cbdc12v2nil	реле
jqx-13f1cbdc24v1d	реле
jqx-13f1cbdc24v1l	реле
jqx-13f1cbdc24v1ld	реле
jqx-13f1cbdc24v1nil	реле
jqx-13f1cbdc24v2d	реле
jqx-13f1cbdc24v2l	реле
jqx-13f1cbdc24v2ld	реле
jqx-13f1cbdc24v2nil	реле
jqx-13f1cbdc36v1d	реле
jqx-13f1cbdc36v1l	реле
jqx-13f1cbdc36v1ld	реле
jqx-13f1cbdc36v1nil	реле
jqx-13f1cbdc36v2d	реле
jqx-13f1cbdc36v2l	реле
jqx-13f1cbdc36v2ld	реле
jqx-13f1cbdc36v2nil	реле
jqx-13f1cbdc48v1d	реле
jqx-13f1cbdc48v1l	реле
jqx-13f1cbdc48v1ld	реле
jqx-13f1cbdc48v1nil	реле

jqx-13f1cbdc48v2d	реле
jqx-13f1cbdc48v2l	реле
jqx-13f1cbdc48v2ld	реле
jqx-13f1cbdc48v2nil	реле
jqx-13f2a	huaxinan [huaxinan electronics co.,ltd], small size, light weight, heavy reverse power
jqx-13f2aaac110v1d	реле
jqx-13f2aaac110v1l	реле
jqx-13f2aaac110v1ld	реле
jqx-13f2aaac110v1nil	реле
jqx-13f2aaac110v2d	реле
jqx-13f2aaac110v2l	реле
jqx-13f2aaac110v2ld	реле
jqx-13f2aaac110v2nil	реле
jqx-13f2aaac12v1d	реле
jqx-13f2aaac12v1l	реле
jqx-13f2aaac12v1ld	реле
jqx-13f2aaac12v1nil	реле
jqx-13f2aaac12v2d	реле
jqx-13f2aaac12v2l	реле
jqx-13f2aaac12v2ld	реле
jqx-13f2aaac12v2nil	реле
jqx-13f2aaac24v1d	реле
jqx-13f2aaac24v1l	реле
jqx-13f2aaac24v1ld	реле
jqx-13f2aaac24v1nil	реле
jqx-13f2aaac24v2d	реле
jqx-13f2aaac24v2l	реле
jqx-13f2aaac24v2ld	реле

jqx-13f2aaac24v2nil	реле
jqx-13f2aaac36v1d	реле
jqx-13f2aaac36v1l	реле
jqx-13f2aaac36v1ld	реле
jqx-13f2aaac36v1nil	реле
jqx-13f2aaac36v2d	реле
jqx-13f2aaac36v2l	реле
jqx-13f2aaac36v2ld	реле
jqx-13f2aaac36v2nil	реле
jqx-13f2aaac48v1d	реле
jqx-13f2aaac48v1l	реле
jqx-13f2aaac48v1ld	реле
jqx-13f2aaac48v1nil	реле
jqx-13f2aaac48v2d	реле
jqx-13f2aaac48v2l	реле
jqx-13f2aaac48v2ld	реле
jqx-13f2aaac48v2nil	реле
jqx-13f2aadc110v1d	реле
jqx-13f2aadc110v1l	реле
jqx-13f2aadc110v1ld	реле
jqx-13f2aadc110v1nil	реле
jqx-13f2aadc110v2d	реле
jqx-13f2aadc110v2l	реле
jqx-13f2aadc110v2ld	реле
jqx-13f2aadc110v2nil	реле
jqx-13f2aadc12v1d	реле
jqx-13f2aadc12v1l	реле
jqx-13f2aadc12v1ld	реле

jqx-13f2aadc12v1nil	реле
jqx-13f2aadc12v2d	реле
jqx-13f2aadc12v2l	реле
jqx-13f2aadc12v2ld	реле
jqx-13f2aadc12v2nil	реле
jqx-13f2aadc24v1d	реле
jqx-13f2aadc24v1l	реле
jqx-13f2aadc24v1ld	реле
jqx-13f2aadc24v1nil	реле
jqx-13f2aadc24v2d	реле
jqx-13f2aadc24v2l	реле
jqx-13f2aadc24v2ld	реле
jqx-13f2aadc24v2nil	реле
jqx-13f2aadc36v1d	реле
jqx-13f2aadc36v1l	реле
jqx-13f2aadc36v1ld	реле
jqx-13f2aadc36v1nil	реле
jqx-13f2aadc36v2d	реле
jqx-13f2aadc36v2l	реле
jqx-13f2aadc36v2ld	реле
jqx-13f2aadc36v2nil	реле
jqx-13f2aadc48v1d	реле
jqx-13f2aadc48v1l	реле
jqx-13f2aadc48v1ld	реле
jqx-13f2aadc48v1nil	реле
jqx-13f2aadc48v2d	реле
jqx-13f2aadc48v2l	реле
jqx-13f2aadc48v2ld	реле

jqx-13f2aac48v2nil	реле
jqx-13f2abac110v1d	реле
jqx-13f2abac110v1l	реле
jqx-13f2abac110v1ld	реле
jqx-13f2abac110v1nil	реле
jqx-13f2abac110v2d	реле
jqx-13f2abac110v2l	реле
jqx-13f2abac110v2ld	реле
jqx-13f2abac110v2nil	реле
jqx-13f2abac12v1d	реле
jqx-13f2abac12v1l	реле
jqx-13f2abac12v1ld	реле
jqx-13f2abac12v1nil	реле
jqx-13f2abac12v2d	реле
jqx-13f2abac12v2l	реле
jqx-13f2abac12v2ld	реле
jqx-13f2abac12v2nil	реле
jqx-13f2abac24v1d	реле
jqx-13f2abac24v1l	реле
jqx-13f2abac24v1ld	реле
jqx-13f2abac24v1nil	реле
jqx-13f2abac24v2d	реле
jqx-13f2abac24v2l	реле
jqx-13f2abac24v2ld	реле
jqx-13f2abac24v2nil	реле
jqx-13f2abac36v1d	реле
jqx-13f2abac36v1l	реле
jqx-13f2abac36v1ld	реле

jqx-13f2abac36v1nil	реле
jqx-13f2abac36v2d	реле
jqx-13f2abac36v2l	реле
jqx-13f2abac36v2ld	реле
jqx-13f2abac36v2nil	реле
jqx-13f2abac48v1d	реле
jqx-13f2abac48v1l	реле
jqx-13f2abac48v1ld	реле
jqx-13f2abac48v1nil	реле
jqx-13f2abac48v2d	реле
jqx-13f2abac48v2l	реле
jqx-13f2abac48v2ld	реле
jqx-13f2abac48v2nil	реле
jqx-13f2abdc110v1d	реле
jqx-13f2abdc110v1l	реле
jqx-13f2abdc110v1ld	реле
jqx-13f2abdc110v1nil	реле
jqx-13f2abdc110v2d	реле
jqx-13f2abdc110v2l	реле
jqx-13f2abdc110v2ld	реле
jqx-13f2abdc110v2nil	реле
jqx-13f2abdc12v1d	реле
jqx-13f2abdc12v1l	реле
jqx-13f2abdc12v1ld	реле
jqx-13f2abdc12v1nil	реле
jqx-13f2abdc12v2d	реле
jqx-13f2abdc12v2l	реле
jqx-13f2abdc12v2ld	реле

jqx-13f2abdc12v2nil	реле
jqx-13f2abdc24v1d	реле
jqx-13f2abdc24v1l	реле
jqx-13f2abdc24v1ld	реле
jqx-13f2abdc24v1nil	реле
jqx-13f2abdc24v2d	реле
jqx-13f2abdc24v2l	реле
jqx-13f2abdc24v2ld	реле
jqx-13f2abdc24v2nil	реле
jqx-13f2abdc36v1d	реле
jqx-13f2abdc36v1l	реле
jqx-13f2abdc36v1ld	реле
jqx-13f2abdc36v1nil	реле
jqx-13f2abdc36v2d	реле
jqx-13f2abdc36v2l	реле
jqx-13f2abdc36v2ld	реле
jqx-13f2abdc36v2nil	реле
jqx-13f2abdc48v1d	реле
jqx-13f2abdc48v1l	реле
jqx-13f2abdc48v1ld	реле
jqx-13f2abdc48v1nil	реле
jqx-13f2abdc48v2d	реле
jqx-13f2abdc48v2l	реле
jqx-13f2abdc48v2ld	реле
jqx-13f2abdc48v2nil	реле
jqx-13f2b	huaxinan [huaxinan electronics co.,ltd], small size, light weight, heavy reverse power
jqx-13f2baac110v1d	реле
jqx-13f2baac110v1l	реле

jqx-13f2baac110v1d	реле
jqx-13f2baac110v1nil	реле
jqx-13f2baac110v2d	реле
jqx-13f2baac110v2l	реле
jqx-13f2baac110v2ld	реле
jqx-13f2baac110v2nil	реле
jqx-13f2baac12v1d	реле
jqx-13f2baac12v1l	реле
jqx-13f2baac12v1ld	реле
jqx-13f2baac12v1nil	реле
jqx-13f2baac12v2d	реле
jqx-13f2baac12v2l	реле
jqx-13f2baac12v2ld	реле
jqx-13f2baac12v2nil	реле
jqx-13f2baac24v1d	реле
jqx-13f2baac24v1l	реле
jqx-13f2baac24v1ld	реле
jqx-13f2baac24v1nil	реле
jqx-13f2baac24v2d	реле
jqx-13f2baac24v2l	реле
jqx-13f2baac24v2ld	реле
jqx-13f2baac24v2nil	реле
jqx-13f2baac36v1d	реле
jqx-13f2baac36v1l	реле
jqx-13f2baac36v1ld	реле
jqx-13f2baac36v1nil	реле
jqx-13f2baac36v2d	реле
jqx-13f2baac36v2l	реле

jqx-13f2baac36v2d	реле
jqx-13f2baac36v2nil	реле
jqx-13f2baac48v1d	реле
jqx-13f2baac48v1l	реле
jqx-13f2baac48v1d	реле
jqx-13f2baac48v1nil	реле
jqx-13f2baac48v2d	реле
jqx-13f2baac48v2l	реле
jqx-13f2baac48v2d	реле
jqx-13f2baac48v2nil	реле
jqx-13f2badc110v1d	реле
jqx-13f2badc110v1l	реле
jqx-13f2badc110v1d	реле
jqx-13f2badc110v1nil	реле
jqx-13f2badc110v2d	реле
jqx-13f2badc110v2l	реле
jqx-13f2badc110v2d	реле
jqx-13f2badc110v2nil	реле
jqx-13f2badc12v1d	реле
jqx-13f2badc12v1l	реле
jqx-13f2badc12v1d	реле
jqx-13f2badc12v1nil	реле
jqx-13f2badc12v2d	реле
jqx-13f2badc12v2l	реле
jqx-13f2badc12v2d	реле
jqx-13f2badc12v2nil	реле
jqx-13f2badc24v1d	реле
jqx-13f2badc24v1l	реле

jqx-13f2badc24v1d	реле
jqx-13f2badc24v1nil	реле
jqx-13f2badc24v2d	реле
jqx-13f2badc24v2l	реле
jqx-13f2badc24v2ld	реле
jqx-13f2badc24v2nil	реле
jqx-13f2badc36v1d	реле
jqx-13f2badc36v1l	реле
jqx-13f2badc36v1ld	реле
jqx-13f2badc36v1nil	реле
jqx-13f2badc36v2d	реле
jqx-13f2badc36v2l	реле
jqx-13f2badc36v2ld	реле
jqx-13f2badc36v2nil	реле
jqx-13f2badc48v1d	реле
jqx-13f2badc48v1l	реле
jqx-13f2badc48v1ld	реле
jqx-13f2badc48v1nil	реле
jqx-13f2badc48v2d	реле
jqx-13f2badc48v2l	реле
jqx-13f2badc48v2ld	реле
jqx-13f2badc48v2nil	реле
jqx-13f2bbac110v1d	реле
jqx-13f2bbac110v1l	реле
jqx-13f2bbac110v1ld	реле
jqx-13f2bbac110v1nil	реле
jqx-13f2bbac110v2d	реле
jqx-13f2bbac110v2l	реле

jqx-13f2bbac110v2ld	реле
jqx-13f2bbac110v2nil	реле
jqx-13f2bbac12v1d	реле
jqx-13f2bbac12v1l	реле
jqx-13f2bbac12v1ld	реле
jqx-13f2bbac12v1nil	реле
jqx-13f2bbac12v2d	реле
jqx-13f2bbac12v2l	реле
jqx-13f2bbac12v2ld	реле
jqx-13f2bbac12v2nil	реле
jqx-13f2bbac24v1d	реле
jqx-13f2bbac24v1l	реле
jqx-13f2bbac24v1ld	реле
jqx-13f2bbac24v1nil	реле
jqx-13f2bbac24v2d	реле
jqx-13f2bbac24v2l	реле
jqx-13f2bbac24v2ld	реле
jqx-13f2bbac24v2nil	реле
jqx-13f2bbac36v1d	реле
jqx-13f2bbac36v1l	реле
jqx-13f2bbac36v1ld	реле
jqx-13f2bbac36v1nil	реле
jqx-13f2bbac36v2d	реле
jqx-13f2bbac36v2l	реле
jqx-13f2bbac36v2ld	реле
jqx-13f2bbac36v2nil	реле
jqx-13f2bbac48v1d	реле
jqx-13f2bbac48v1l	реле

jqx-13f2bbac48v1d	реле
jqx-13f2bbac48v1nil	реле
jqx-13f2bbac48v2d	реле
jqx-13f2bbac48v2l	реле
jqx-13f2bbac48v2ld	реле
jqx-13f2bbac48v2nil	реле
jqx-13f2bbdc110v1d	реле
jqx-13f2bbdc110v1l	реле
jqx-13f2bbdc110v1ld	реле
jqx-13f2bbdc110v1nil	реле
jqx-13f2bbdc110v2d	реле
jqx-13f2bbdc110v2l	реле
jqx-13f2bbdc110v2ld	реле
jqx-13f2bbdc110v2nil	реле
jqx-13f2bbdc12v1d	реле
jqx-13f2bbdc12v1l	реле
jqx-13f2bbdc12v1ld	реле
jqx-13f2bbdc12v1nil	реле
jqx-13f2bbdc12v2d	реле
jqx-13f2bbdc12v2l	реле
jqx-13f2bbdc12v2ld	реле
jqx-13f2bbdc12v2nil	реле
jqx-13f2bbdc24v1d	реле
jqx-13f2bbdc24v1l	реле
jqx-13f2bbdc24v1ld	реле
jqx-13f2bbdc24v1nil	реле
jqx-13f2bbdc24v2d	реле
jqx-13f2bbdc24v2l	реле

jqx-13f2bbdc24v2d	реле
jqx-13f2bbdc24v2nil	реле
jqx-13f2bbdc36v1d	реле
jqx-13f2bbdc36v1l	реле
jqx-13f2bbdc36v1d	реле
jqx-13f2bbdc36v1nil	реле
jqx-13f2bbdc36v2d	реле
jqx-13f2bbdc36v2l	реле
jqx-13f2bbdc36v2d	реле
jqx-13f2bbdc36v2nil	реле
jqx-13f2bbdc48v1d	реле
jqx-13f2bbdc48v1l	реле
jqx-13f2bbdc48v1d	реле
jqx-13f2bbdc48v1nil	реле
jqx-13f2bbdc48v2d	реле
jqx-13f2bbdc48v2l	реле
jqx-13f2bbdc48v2d	реле
jqx-13f2bbdc48v2nil	реле
jqx-13f2c	huaxinan [huaxinan electronics co.,ltd], small size, light weight, heavy reverse powe
jqx-13f2caac110v1d	реле
jqx-13f2caac110v1l	реле
jqx-13f2caac110v1d	реле
jqx-13f2caac110v1nil	реле
jqx-13f2caac110v2d	реле
jqx-13f2caac110v2l	реле
jqx-13f2caac110v2d	реле
jqx-13f2caac110v2nil	реле
jqx-13f2caac12v1d	реле

jqx-13f2caac12v1l	реле
jqx-13f2caac12v1ld	реле
jqx-13f2caac12v1nil	реле
jqx-13f2caac12v2d	реле
jqx-13f2caac12v2l	реле
jqx-13f2caac12v2ld	реле
jqx-13f2caac12v2nil	реле
jqx-13f2caac24v1d	реле
jqx-13f2caac24v1l	реле
jqx-13f2caac24v1ld	реле
jqx-13f2caac24v1nil	реле
jqx-13f2caac24v2d	реле
jqx-13f2caac24v2l	реле
jqx-13f2caac24v2ld	реле
jqx-13f2caac24v2nil	реле
jqx-13f2caac36v1d	реле
jqx-13f2caac36v1l	реле
jqx-13f2caac36v1ld	реле
jqx-13f2caac36v1nil	реле
jqx-13f2caac36v2d	реле
jqx-13f2caac36v2l	реле
jqx-13f2caac36v2ld	реле
jqx-13f2caac36v2nil	реле
jqx-13f2caac48v1d	реле
jqx-13f2caac48v1l	реле
jqx-13f2caac48v1ld	реле
jqx-13f2caac48v1nil	реле
jqx-13f2caac48v2d	реле

jqx-13f2caac48v2l	реле
jqx-13f2caac48v2ld	реле
jqx-13f2caac48v2nil	реле
jqx-13f2cad110v1d	реле
jqx-13f2cad110v1l	реле
jqx-13f2cad110v1ld	реле
jqx-13f2cad110v1nil	реле
jqx-13f2cad110v2d	реле
jqx-13f2cad110v2l	реле
jqx-13f2cad110v2ld	реле
jqx-13f2cad110v2nil	реле
jqx-13f2cad12v1d	реле
jqx-13f2cad12v1l	реле
jqx-13f2cad12v1ld	реле
jqx-13f2cad12v1nil	реле
jqx-13f2cad12v2d	реле
jqx-13f2cad12v2l	реле
jqx-13f2cad12v2ld	реле
jqx-13f2cad12v2nil	реле
jqx-13f2cad24v1d	реле
jqx-13f2cad24v1l	реле
jqx-13f2cad24v1ld	реле
jqx-13f2cad24v1nil	реле
jqx-13f2cad24v2d	реле
jqx-13f2cad24v2l	реле
jqx-13f2cad24v2ld	реле
jqx-13f2cad24v2nil	реле
jqx-13f2cad36v1d	реле

jqx-13f2cad36v1l	реле
jqx-13f2cad36v1d	реле
jqx-13f2cad36v1nil	реле
jqx-13f2cad36v2d	реле
jqx-13f2cad36v2l	реле
jqx-13f2cad36v2d	реле
jqx-13f2cad36v2nil	реле
jqx-13f2cad48v1d	реле
jqx-13f2cad48v1l	реле
jqx-13f2cad48v1d	реле
jqx-13f2cad48v1nil	реле
jqx-13f2cad48v2d	реле
jqx-13f2cad48v2l	реле
jqx-13f2cad48v2d	реле
jqx-13f2cad48v2nil	реле
jqx-13f2cbac110v1d	реле
jqx-13f2cbac110v1l	реле
jqx-13f2cbac110v1d	реле
jqx-13f2cbac110v1nil	реле
jqx-13f2cbac110v2d	реле
jqx-13f2cbac110v2l	реле
jqx-13f2cbac110v2d	реле
jqx-13f2cbac110v2nil	реле
jqx-13f2cbac12v1d	реле
jqx-13f2cbac12v1l	реле
jqx-13f2cbac12v1d	реле
jqx-13f2cbac12v1nil	реле
jqx-13f2cbac12v2d	реле

jqx-13f2cbac12v2l	реле
jqx-13f2cbac12v2ld	реле
jqx-13f2cbac12v2nil	реле
jqx-13f2cbac24v1d	реле
jqx-13f2cbac24v1l	реле
jqx-13f2cbac24v1ld	реле
jqx-13f2cbac24v1nil	реле
jqx-13f2cbac24v2d	реле
jqx-13f2cbac24v2l	реле
jqx-13f2cbac24v2ld	реле
jqx-13f2cbac24v2nil	реле
jqx-13f2cbac36v1d	реле
jqx-13f2cbac36v1l	реле
jqx-13f2cbac36v1ld	реле
jqx-13f2cbac36v1nil	реле
jqx-13f2cbac36v2d	реле
jqx-13f2cbac36v2l	реле
jqx-13f2cbac36v2ld	реле
jqx-13f2cbac36v2nil	реле
jqx-13f2cbac48v1d	реле
jqx-13f2cbac48v1l	реле
jqx-13f2cbac48v1ld	реле
jqx-13f2cbac48v1nil	реле
jqx-13f2cbac48v2d	реле
jqx-13f2cbac48v2l	реле
jqx-13f2cbac48v2ld	реле
jqx-13f2cbac48v2nil	реле
jqx-13f2cbdc110v1d	реле

jqx-13f2cbdc110v1l	реле
jqx-13f2cbdc110v1ld	реле
jqx-13f2cbdc110v1nil	реле
jqx-13f2cbdc110v2d	реле
jqx-13f2cbdc110v2l	реле
jqx-13f2cbdc110v2ld	реле
jqx-13f2cbdc110v2nil	реле
jqx-13f2cbdc12v1d	реле
jqx-13f2cbdc12v1l	реле
jqx-13f2cbdc12v1ld	реле
jqx-13f2cbdc12v1nil	реле
jqx-13f2cbdc12v2d	реле
jqx-13f2cbdc12v2l	реле
jqx-13f2cbdc12v2ld	реле
jqx-13f2cbdc12v2nil	реле
jqx-13f2cbdc24v1d	реле
jqx-13f2cbdc24v1l	реле
jqx-13f2cbdc24v1ld	реле
jqx-13f2cbdc24v1nil	реле
jqx-13f2cbdc24v2d	реле
jqx-13f2cbdc24v2l	реле
jqx-13f2cbdc24v2ld	реле
jqx-13f2cbdc24v2nil	реле
jqx-13f2cbdc36v1d	реле
jqx-13f2cbdc36v1l	реле
jqx-13f2cbdc36v1ld	реле
jqx-13f2cbdc36v1nil	реле
jqx-13f2cbdc36v2d	реле

jqx-13f2cbdc36v2l	реле
jqx-13f2cbdc36v2ld	реле
jqx-13f2cbdc36v2nil	реле
jqx-13f2cbdc48v1d	реле
jqx-13f2cbdc48v1l	реле
jqx-13f2cbdc48v1ld	реле
jqx-13f2cbdc48v1nil	реле
jqx-13f2cbdc48v2d	реле
jqx-13f2cbdc48v2l	реле
jqx-13f2cbdc48v2ld	реле
jqx-13f2cbdc48v2nil	реле
jqx-13f3c	huaxinan [huaxinan electronics co.,ltd], small size, light weight, heavy reverse power
jqx-13f3caac110v1d	реле
jqx-13f3caac110v1l	реле
jqx-13f3caac110v1ld	реле
jqx-13f3caac110v1nil	реле
jqx-13f3caac110v2d	реле
jqx-13f3caac110v2l	реле
jqx-13f3caac110v2ld	реле
jqx-13f3caac110v2nil	реле
jqx-13f3caac12v1d	реле
jqx-13f3caac12v1l	реле
jqx-13f3caac12v1ld	реле
jqx-13f3caac12v1nil	реле
jqx-13f3caac12v2d	реле
jqx-13f3caac12v2l	реле
jqx-13f3caac12v2ld	реле
jqx-13f3caac12v2nil	реле

jqx-13f3caac24v1d	реле
jqx-13f3caac24v1l	реле
jqx-13f3caac24v1ld	реле
jqx-13f3caac24v1nil	реле
jqx-13f3caac24v2d	реле
jqx-13f3caac24v2l	реле
jqx-13f3caac24v2ld	реле
jqx-13f3caac24v2nil	реле
jqx-13f3caac36v1d	реле
jqx-13f3caac36v1l	реле
jqx-13f3caac36v1ld	реле
jqx-13f3caac36v1nil	реле
jqx-13f3caac36v2d	реле
jqx-13f3caac36v2l	реле
jqx-13f3caac36v2ld	реле
jqx-13f3caac36v2nil	реле
jqx-13f3caac48v1d	реле
jqx-13f3caac48v1l	реле
jqx-13f3caac48v1ld	реле
jqx-13f3caac48v1nil	реле
jqx-13f3caac48v2d	реле
jqx-13f3caac48v2l	реле
jqx-13f3caac48v2ld	реле
jqx-13f3caac48v2nil	реле
jqx-13f3cadc110v1d	реле
jqx-13f3cadc110v1l	реле
jqx-13f3cadc110v1ld	реле
jqx-13f3cadc110v1nil	реле

jqx-13f3cadc110v2d	реле
jqx-13f3cadc110v2l	реле
jqx-13f3cadc110v2ld	реле
jqx-13f3cadc110v2nil	реле
jqx-13f3cadc12v1d	реле
jqx-13f3cadc12v1l	реле
jqx-13f3cadc12v1ld	реле
jqx-13f3cadc12v1nil	реле
jqx-13f3cadc12v2d	реле
jqx-13f3cadc12v2l	реле
jqx-13f3cadc12v2ld	реле
jqx-13f3cadc12v2nil	реле
jqx-13f3cadc24v1d	реле
jqx-13f3cadc24v1l	реле
jqx-13f3cadc24v1ld	реле
jqx-13f3cadc24v1nil	реле
jqx-13f3cadc24v2d	реле
jqx-13f3cadc24v2l	реле
jqx-13f3cadc24v2ld	реле
jqx-13f3cadc24v2nil	реле
jqx-13f3cadc36v1d	реле
jqx-13f3cadc36v1l	реле
jqx-13f3cadc36v1ld	реле
jqx-13f3cadc36v1nil	реле
jqx-13f3cadc36v2d	реле
jqx-13f3cadc36v2l	реле
jqx-13f3cadc36v2ld	реле
jqx-13f3cadc36v2nil	реле

jqx-13f3cad48v1d	реле
jqx-13f3cad48v1l	реле
jqx-13f3cad48v1ld	реле
jqx-13f3cad48v1nil	реле
jqx-13f3cad48v2d	реле
jqx-13f3cad48v2l	реле
jqx-13f3cad48v2ld	реле
jqx-13f3cad48v2nil	реле
jqx-13f3cbac110v1d	реле
jqx-13f3cbac110v1l	реле
jqx-13f3cbac110v1ld	реле
jqx-13f3cbac110v1nil	реле
jqx-13f3cbac110v2d	реле
jqx-13f3cbac110v2l	реле
jqx-13f3cbac110v2ld	реле
jqx-13f3cbac110v2nil	реле
jqx-13f3cbac12v1d	реле
jqx-13f3cbac12v1l	реле
jqx-13f3cbac12v1ld	реле
jqx-13f3cbac12v1nil	реле
jqx-13f3cbac12v2d	реле
jqx-13f3cbac12v2l	реле
jqx-13f3cbac12v2ld	реле
jqx-13f3cbac12v2nil	реле
jqx-13f3cbac24v1d	реле
jqx-13f3cbac24v1l	реле
jqx-13f3cbac24v1ld	реле
jqx-13f3cbac24v1nil	реле

jqx-13f3cbac24v2d	реле
jqx-13f3cbac24v2l	реле
jqx-13f3cbac24v2ld	реле
jqx-13f3cbac24v2nil	реле
jqx-13f3cbac36v1d	реле
jqx-13f3cbac36v1l	реле
jqx-13f3cbac36v1ld	реле
jqx-13f3cbac36v1nil	реле
jqx-13f3cbac36v2d	реле
jqx-13f3cbac36v2l	реле
jqx-13f3cbac36v2ld	реле
jqx-13f3cbac36v2nil	реле
jqx-13f3cbac48v1d	реле
jqx-13f3cbac48v1l	реле
jqx-13f3cbac48v1ld	реле
jqx-13f3cbac48v1nil	реле
jqx-13f3cbac48v2d	реле
jqx-13f3cbac48v2l	реле
jqx-13f3cbac48v2ld	реле
jqx-13f3cbac48v2nil	реле
jqx-13f3cbdc110v1d	реле
jqx-13f3cbdc110v1l	реле
jqx-13f3cbdc110v1ld	реле
jqx-13f3cbdc110v1nil	реле
jqx-13f3cbdc110v2d	реле
jqx-13f3cbdc110v2l	реле
jqx-13f3cbdc110v2ld	реле
jqx-13f3cbdc110v2nil	реле

jqx-13f3cbdc12v1d	реле
jqx-13f3cbdc12v1l	реле
jqx-13f3cbdc12v1ld	реле
jqx-13f3cbdc12v1nil	реле
jqx-13f3cbdc12v2d	реле
jqx-13f3cbdc12v2l	реле
jqx-13f3cbdc12v2ld	реле
jqx-13f3cbdc12v2nil	реле
jqx-13f3cbdc24v1d	реле
jqx-13f3cbdc24v1l	реле
jqx-13f3cbdc24v1ld	реле
jqx-13f3cbdc24v1nil	реле
jqx-13f3cbdc24v2d	реле
jqx-13f3cbdc24v2l	реле
jqx-13f3cbdc24v2ld	реле
jqx-13f3cbdc24v2nil	реле
jqx-13f3cbdc36v1d	реле
jqx-13f3cbdc36v1l	реле
jqx-13f3cbdc36v1ld	реле
jqx-13f3cbdc36v1nil	реле
jqx-13f3cbdc36v2d	реле
jqx-13f3cbdc36v2l	реле
jqx-13f3cbdc36v2ld	реле
jqx-13f3cbdc36v2nil	реле
jqx-13f3cbdc48v1d	реле
jqx-13f3cbdc48v1l	реле
jqx-13f3cbdc48v1ld	реле
jqx-13f3cbdc48v1nil	реле

jqx-13f3cbdc48v2d	реле
jqx-13f3cbdc48v2l	реле
jqx-13f3cbdc48v2ld	реле
jqx-13f3cbdc48v2nil	реле
jqx-13f4c	huaxinan [huaxinan electronics co.,ltd], small size, light weight, heavy reverse power
jqx-13f4caac110v1d	реле
jqx-13f4caac110v1l	реле
jqx-13f4caac110v1ld	реле
jqx-13f4caac110v1nil	реле
jqx-13f4caac110v2d	реле
jqx-13f4caac110v2l	реле
jqx-13f4caac110v2ld	реле
jqx-13f4caac110v2nil	реле
jqx-13f4caac12v1d	реле
jqx-13f4caac12v1l	реле
jqx-13f4caac12v1ld	реле
jqx-13f4caac12v1nil	реле
jqx-13f4caac12v2d	реле
jqx-13f4caac12v2l	реле
jqx-13f4caac12v2ld	реле
jqx-13f4caac12v2nil	реле
jqx-13f4caac24v1d	реле
jqx-13f4caac24v1l	реле
jqx-13f4caac24v1ld	реле
jqx-13f4caac24v1nil	реле
jqx-13f4caac24v2d	реле
jqx-13f4caac24v2l	реле
jqx-13f4caac24v2ld	реле

jqx-13f4caac24v2nil	реле
jqx-13f4caac36v1d	реле
jqx-13f4caac36v1l	реле
jqx-13f4caac36v1ld	реле
jqx-13f4caac36v1nil	реле
jqx-13f4caac36v2d	реле
jqx-13f4caac36v2l	реле
jqx-13f4caac36v2ld	реле
jqx-13f4caac36v2nil	реле
jqx-13f4caac48v1d	реле
jqx-13f4caac48v1l	реле
jqx-13f4caac48v1ld	реле
jqx-13f4caac48v1nil	реле
jqx-13f4caac48v2d	реле
jqx-13f4caac48v2l	реле
jqx-13f4caac48v2ld	реле
jqx-13f4caac48v2nil	реле
jqx-13f4cadc110v1d	реле
jqx-13f4cadc110v1l	реле
jqx-13f4cadc110v1ld	реле
jqx-13f4cadc110v1nil	реле
jqx-13f4cadc110v2d	реле
jqx-13f4cadc110v2l	реле
jqx-13f4cadc110v2ld	реле
jqx-13f4cadc110v2nil	реле
jqx-13f4cadc12v1d	реле
jqx-13f4cadc12v1l	реле
jqx-13f4cadc12v1ld	реле

jqx-13f4cadc12v1nil	реле
jqx-13f4cadc12v2d	реле
jqx-13f4cadc12v2l	реле
jqx-13f4cadc12v2ld	реле
jqx-13f4cadc12v2nil	реле
jqx-13f4cadc24v1d	реле
jqx-13f4cadc24v1l	реле
jqx-13f4cadc24v1ld	реле
jqx-13f4cadc24v1nil	реле
jqx-13f4cadc24v2d	реле
jqx-13f4cadc24v2l	реле
jqx-13f4cadc24v2ld	реле
jqx-13f4cadc24v2nil	реле
jqx-13f4cadc36v1d	реле
jqx-13f4cadc36v1l	реле
jqx-13f4cadc36v1ld	реле
jqx-13f4cadc36v1nil	реле
jqx-13f4cadc36v2d	реле
jqx-13f4cadc36v2l	реле
jqx-13f4cadc36v2ld	реле
jqx-13f4cadc36v2nil	реле
jqx-13f4cadc48v1d	реле
jqx-13f4cadc48v1l	реле
jqx-13f4cadc48v1ld	реле
jqx-13f4cadc48v1nil	реле
jqx-13f4cadc48v2d	реле
jqx-13f4cadc48v2l	реле
jqx-13f4cadc48v2ld	реле

jqx-13f4cadc48v2nil	реле
jqx-13f4cbac110v1d	реле
jqx-13f4cbac110v1l	реле
jqx-13f4cbac110v1ld	реле
jqx-13f4cbac110v1nil	реле
jqx-13f4cbac110v2d	реле
jqx-13f4cbac110v2l	реле
jqx-13f4cbac110v2ld	реле
jqx-13f4cbac110v2nil	реле
jqx-13f4cbac12v1d	реле
jqx-13f4cbac12v1l	реле
jqx-13f4cbac12v1ld	реле
jqx-13f4cbac12v1nil	реле
jqx-13f4cbac12v2d	реле
jqx-13f4cbac12v2l	реле
jqx-13f4cbac12v2ld	реле
jqx-13f4cbac12v2nil	реле
jqx-13f4cbac24v1d	реле
jqx-13f4cbac24v1l	реле
jqx-13f4cbac24v1ld	реле
jqx-13f4cbac24v1nil	реле
jqx-13f4cbac24v2d	реле
jqx-13f4cbac24v2l	реле
jqx-13f4cbac24v2ld	реле
jqx-13f4cbac24v2nil	реле
jqx-13f4cbac36v1d	реле
jqx-13f4cbac36v1l	реле
jqx-13f4cbac36v1ld	реле

jqx-13f4cbac36v1nil	реле
jqx-13f4cbac36v2d	реле
jqx-13f4cbac36v2l	реле
jqx-13f4cbac36v2ld	реле
jqx-13f4cbac36v2nil	реле
jqx-13f4cbac48v1d	реле
jqx-13f4cbac48v1l	реле
jqx-13f4cbac48v1ld	реле
jqx-13f4cbac48v1nil	реле
jqx-13f4cbac48v2d	реле
jqx-13f4cbac48v2l	реле
jqx-13f4cbac48v2ld	реле
jqx-13f4cbac48v2nil	реле
jqx-13f4cbdc110v1d	реле
jqx-13f4cbdc110v1l	реле
jqx-13f4cbdc110v1ld	реле
jqx-13f4cbdc110v1nil	реле
jqx-13f4cbdc110v2d	реле
jqx-13f4cbdc110v2l	реле
jqx-13f4cbdc110v2ld	реле
jqx-13f4cbdc110v2nil	реле
jqx-13f4cbdc12v1d	реле
jqx-13f4cbdc12v1l	реле
jqx-13f4cbdc12v1ld	реле
jqx-13f4cbdc12v1nil	реле
jqx-13f4cbdc12v2d	реле
jqx-13f4cbdc12v2l	реле
jqx-13f4cbdc12v2ld	реле

jqx-13f4cbdc12v2nil	реле
jqx-13f4cbdc24v1d	реле
jqx-13f4cbdc24v1l	реле
jqx-13f4cbdc24v1ld	реле
jqx-13f4cbdc24v1nil	реле
jqx-13f4cbdc24v2d	реле
jqx-13f4cbdc24v2l	реле
jqx-13f4cbdc24v2ld	реле
jqx-13f4cbdc24v2nil	реле
jqx-13f4cbdc36v1d	реле
jqx-13f4cbdc36v1l	реле
jqx-13f4cbdc36v1ld	реле
jqx-13f4cbdc36v1nil	реле
jqx-13f4cbdc36v2d	реле
jqx-13f4cbdc36v2l	реле
jqx-13f4cbdc36v2ld	реле
jqx-13f4cbdc36v2nil	реле
jqx-13f4cbdc48v1d	реле
jqx-13f4cbdc48v1l	реле
jqx-13f4cbdc48v1ld	реле
jqx-13f4cbdc48v1nil	реле
jqx-13f4cbdc48v2d	реле
jqx-13f4cbdc48v2l	реле
jqx-13f4cbdc48v2ld	реле
jqx-13f4cbdc48v2nil	реле
jqx-140ff	etc1 [list of unclassified manufacturers], double-pole, 10a, boar
jqx-141ff	huaxinan [huaxinan electronics co.,ltd], slim type and small occupying area can offer high density p.c.b. techniqu
jqx-141ff/005dnlnilg	реле

jqx-141ff/005dnlnilnil	реле
jqx-141ff/005dnlnilpg	реле
jqx-141ff/005dnlnilpnil	реле
jqx-141ff/005dsnilg	реле
jqx-141ff/005dsnilnil	реле
jqx-141ff/005dspg	реле
jqx-141ff/005dspnil	реле
jqx-141ff/005hlnilnilg	реле
jqx-141ff/005hlnilnilnil	реле
jqx-141ff/005hlnilpg	реле
jqx-141ff/005hlnilpnil	реле
jqx-141ff/005hsnilg	реле
jqx-141ff/005hsnilnil	реле
jqx-141ff/005hspg	реле
jqx-141ff/005hspnil	реле
jqx-141ff/005znlnilnilg	реле
jqx-141ff/005znlnilnilnil	реле
jqx-141ff/005znlnilpg	реле
jqx-141ff/005znlnilpnil	реле
jqx-141ff/005zsnilg	реле
jqx-141ff/005zsnilnil	реле
jqx-141ff/005zspg	реле
jqx-141ff/005zspnil	реле
jqx-141ff/006dnlnilnilg	реле
jqx-141ff/006dnlnilnilnil	реле
jqx-141ff/006dnlnilpg	реле
jqx-141ff/006dnlnilpnil	реле
jqx-141ff/006dsnilg	реле

jqx-141ff/006dsnilnil	реле
jqx-141ff/006dspg	реле
jqx-141ff/006dspnil	реле
jqx-141ff/006hnilnilg	реле
jqx-141ff/006hnilnilnil	реле
jqx-141ff/006hnilpg	реле
jqx-141ff/006hnilpnil	реле
jqx-141ff/006hsnilg	реле
jqx-141ff/006hsnilnil	реле
jqx-141ff/006hspg	реле
jqx-141ff/006hspnil	реле
jqx-141ff/006znilnilg	реле
jqx-141ff/006znilnilnil	реле
jqx-141ff/006znilpg	реле
jqx-141ff/006znilpnil	реле
jqx-141ff/006zsnilg	реле
jqx-141ff/006zsnilnil	реле
jqx-141ff/006zspg	реле
jqx-141ff/006zspnil	реле
jqx-141ff/009dnilnilg	реле
jqx-141ff/009dnilnilnil	реле
jqx-141ff/009dnilpg	реле
jqx-141ff/009dnilpnil	реле
jqx-141ff/009dsnilg	реле
jqx-141ff/009dsnilnil	реле
jqx-141ff/009dspg	реле
jqx-141ff/009dspnil	реле
jqx-141ff/009hnilnilg	реле

jqx-141ff/009hnilnilnil	реле
jqx-141ff/009hnilpg	реле
jqx-141ff/009hnilpnil	реле
jqx-141ff/009hsnilg	реле
jqx-141ff/009hsnilnil	реле
jqx-141ff/009hspg	реле
jqx-141ff/009hspnil	реле
jqx-141ff/009znilnilg	реле
jqx-141ff/009znilnilnil	реле
jqx-141ff/009znilpg	реле
jqx-141ff/009znilpnil	реле
jqx-141ff/009zsnilg	реле
jqx-141ff/009zsnilnil	реле
jqx-141ff/009zspg	реле
jqx-141ff/009zspnil	реле
jqx-141ff/012dnilnilg	реле
jqx-141ff/012dnilnilnil	реле
jqx-141ff/012dnilpg	реле
jqx-141ff/012dnilpnil	реле
jqx-141ff/012dsnilg	реле
jqx-141ff/012dsnilnil	реле
jqx-141ff/012dspg	реле
jqx-141ff/012dspnil	реле
jqx-141ff/012hnilnilg	реле
jqx-141ff/012hnilnilnil	реле
jqx-141ff/012hnilpg	реле
jqx-141ff/012hnilpnil	реле
jqx-141ff/012hsnilg	реле

jqx-141ff/012hsnilnil	реле
jqx-141ff/012hspg	реле
jqx-141ff/012hsnil	реле
jqx-141ff/012znilnilg	реле
jqx-141ff/012znilnilnil	реле
jqx-141ff/012znilpg	реле
jqx-141ff/012znilpnil	реле
jqx-141ff/012zsnilg	реле
jqx-141ff/012zsnilnil	реле
jqx-141ff/012zspg	реле
jqx-141ff/012zspnil	реле
jqx-141ff/018dnilnilg	реле
jqx-141ff/018dnilnilnil	реле
jqx-141ff/018dnilpg	реле
jqx-141ff/018dnilpnil	реле
jqx-141ff/018dsnilg	реле
jqx-141ff/018dsnilnil	реле
jqx-141ff/018dspg	реле
jqx-141ff/018dspnil	реле
jqx-141ff/018hnilnilg	реле
jqx-141ff/018hnilnilnil	реле
jqx-141ff/018hnilpg	реле
jqx-141ff/018hnilpnil	реле
jqx-141ff/018hsnilg	реле
jqx-141ff/018hsnilnil	реле
jqx-141ff/018hspg	реле
jqx-141ff/018hsnil	реле
jqx-141ff/018znilnilg	реле

jqx-141ff/018znilnilnil	реле
jqx-141ff/018znilpg	реле
jqx-141ff/018znilpnil	реле
jqx-141ff/018zsnilg	реле
jqx-141ff/018zsnilnil	реле
jqx-141ff/018zspg	реле
jqx-141ff/018zspnil	реле
jqx-141ff/024dnilnilg	реле
jqx-141ff/024dnilnilnil	реле
jqx-141ff/024dnilpg	реле
jqx-141ff/024dnilpnil	реле
jqx-141ff/024dsnlg	реле
jqx-141ff/024dsnlgnilnil	реле
jqx-141ff/024dspg	реле
jqx-141ff/024dspnil	реле
jqx-141ff/024hnilnilg	реле
jqx-141ff/024hnilnilnil	реле
jqx-141ff/024hnilpg	реле
jqx-141ff/024hnilpnil	реле
jqx-141ff/024hsnlg	реле
jqx-141ff/024hsnlgnilnil	реле
jqx-141ff/024hspg	реле
jqx-141ff/024hspnil	реле
jqx-141ff/024znilnilg	реле
jqx-141ff/024znilnilnil	реле
jqx-141ff/024znilpg	реле
jqx-141ff/024znilpnil	реле
jqx-141ff/024zsnlg	реле

jqx-141ff/024zsnlnil реле
jqx-141ff/024zspg реле
jqx-141ff/024zspnil реле
jqx-141ff/048dnlnilg реле
jqx-141ff/048dnlnilnil реле
jqx-141ff/048dnlnilpg реле
jqx-141ff/048dnlnilpnil реле
jqx-141ff/048dsnilg реле
jqx-141ff/048dsnilnil реле
jqx-141ff/048dspg реле
jqx-141ff/048dspnil реле
jqx-141ff/048hlnilnilg реле
jqx-141ff/048hlnilnilnil реле
jqx-141ff/048hlnilnilpg реле
jqx-141ff/048hlnilnilpnil реле
jqx-141ff/048hsnilg реле
jqx-141ff/048hsnilnil реле
jqx-141ff/048hspg реле
jqx-141ff/048hspnil реле
jqx-141ff/048znlnilnilg реле
jqx-141ff/048znlnilnilnil реле
jqx-141ff/048znlnilnilpg реле
jqx-141ff/048znlnilnilpnil реле
jqx-141ff/048zsnilg реле
jqx-141ff/048zsnilnil реле
jqx-141ff/048zspg реле
jqx-141ff/048zspnil реле

jqx-141ff1a huaxinan [huaxinan electronics co.,ltd], slim type and small occupying area can offer high density p.c.b. techniqu

jqx-141ff1as10adc30.543.3	реле switching capacity from 10a 16
jqx-141ff1as10adc50.543.3	реле switching capacity from 10a 16
jqx-141ff1as10adc60.543.3	реле switching capacity from 10a 16
jqx-141ff1as10adc90.543.3	реле switching capacity from 10a 16
jqx-141ff1as16adc30.543.3	реле switching capacity from 10a 16
jqx-141ff1as16adc50.543.3	реле switching capacity from 10a 16
jqx-141ff1as16adc60.543.3	реле switching capacity from 10a 16
jqx-141ff1as16adc90.543.3	реле switching capacity from 10a 16
jqx-141ff1as5adc120.543.3	реле switching capacity from 10a 16
jqx-141ff1as5adc30.543.3	реле switching capacity from 10a 16
jqx-141ff1as5adc50.543.3	реле switching capacity from 10a 16
jqx-141ff1as5adc60.543.3	реле switching capacity from 10a 16
jqx-141ff1as5adc90.543.3	реле switching capacity from 10a 16
jqx-141ff1as8adc120.543.3	реле switching capacity from 10a 16
jqx-141ff1as8adc30.543.3	реле switching capacity from 10a 16
jqx-141ff1as8adc50.543.3	реле switching capacity from 10a 16
jqx-141ff1as8adc60.543.3	реле switching capacity from 10a 16
jqx-141ff1as8adc90.543.3	реле switching capacity from 10a 16
jqx-141ff1az10adc30.543.3	реле switching capacity from 10a 16
jqx-141ff1az10adc50.543.3	реле switching capacity from 10a 16
jqx-141ff1az10adc60.543.3	реле switching capacity from 10a 16
jqx-141ff1az10adc90.543.3	реле switching capacity from 10a 16
jqx-141ff1az16adc30.543.3	реле switching capacity from 10a 16
jqx-141ff1az16adc50.543.3	реле switching capacity from 10a 16
jqx-141ff1az16adc60.543.3	реле switching capacity from 10a 16
jqx-141ff1az16adc90.543.3	реле switching capacity from 10a 16
jqx-141ff1az5adc120.543.3	реле switching capacity from 10a 16
jqx-141ff1az5adc30.543.3	реле switching capacity from 10a 16

jqx-141ff1az5adc50.543.3	реле switching capacity from 10a 16
jqx-141ff1az5adc60.543.3	реле switching capacity from 10a 16
jqx-141ff1az5adc90.543.3	реле switching capacity from 10a 16
jqx-141ff1az8adc120.543.3	реле switching capacity from 10a 16
jqx-141ff1az8adc30.543.3	реле switching capacity from 10a 16
jqx-141ff1az8adc50.543.3	реле switching capacity from 10a 16
jqx-141ff1az8adc60.543.3	реле switching capacity from 10a 16
jqx-141ff1az8adc90.543.3	реле switching capacity from 10a 16
jqx-141ff1c	huaxinan [huaxinan electronics co.,ltd], slim type and small occupying area can offer high density p.c.b. techniqu
jqx-141ff1cs10adc30.543.3	реле switching capacity from 10a 16
jqx-141ff1cs10adc50.543.3	реле switching capacity from 10a 16
jqx-141ff1cs10adc60.543.3	реле switching capacity from 10a 16
jqx-141ff1cs10adc90.543.3	реле switching capacity from 10a 16
jqx-141ff1cs16adc30.543.3	реле switching capacity from 10a 16
jqx-141ff1cs16adc50.543.3	реле switching capacity from 10a 16
jqx-141ff1cs16adc60.543.3	реле switching capacity from 10a 16
jqx-141ff1cs16adc90.543.3	реле switching capacity from 10a 16
jqx-141ff1cs5adc120.543.3	реле switching capacity from 10a 16
jqx-141ff1cs5adc30.543.3	реле switching capacity from 10a 16
jqx-141ff1cs5adc50.543.3	реле switching capacity from 10a 16
jqx-141ff1cs5adc60.543.3	реле switching capacity from 10a 16
jqx-141ff1cs5adc90.543.3	реле switching capacity from 10a 16
jqx-141ff1cs8adc120.543.3	реле switching capacity from 10a 16
jqx-141ff1cs8adc30.543.3	реле switching capacity from 10a 16
jqx-141ff1cs8adc50.543.3	реле switching capacity from 10a 16
jqx-141ff1cs8adc60.543.3	реле switching capacity from 10a 16
jqx-141ff1cs8adc90.543.3	реле switching capacity from 10a 16
jqx-141ff1cz10adc30.543.3	реле switching capacity from 10a 16

jqx-141ff1cz10adc50.543.3	реле switching capacity from 10a 16
jqx-141ff1cz10adc60.543.3	реле switching capacity from 10a 16
jqx-141ff1cz10adc90.543.3	реле switching capacity from 10a 16
jqx-141ff1cz16adc30.543.3	реле switching capacity from 10a 16
jqx-141ff1cz16adc50.543.3	реле switching capacity from 10a 16
jqx-141ff1cz16adc60.543.3	реле switching capacity from 10a 16
jqx-141ff1cz16adc90.543.3	реле switching capacity from 10a 16
jqx-141ff1cz5adc120.543.3	реле switching capacity from 10a 16
jqx-141ff1cz5adc30.543.3	реле switching capacity from 10a 16
jqx-141ff1cz5adc50.543.3	реле switching capacity from 10a 16
jqx-141ff1cz5adc60.543.3	реле switching capacity from 10a 16
jqx-141ff1cz5adc90.543.3	реле switching capacity from 10a 16
jqx-141ff1cz8adc120.543.3	реле switching capacity from 10a 16
jqx-141ff1cz8adc30.543.3	реле switching capacity from 10a 16
jqx-141ff1cz8adc50.543.3	реле switching capacity from 10a 16
jqx-141ff1cz8adc60.543.3	реле switching capacity from 10a 16
jqx-141ff1cz8adc90.543.3	реле switching capacity from 10a 16
jqx-141ff2a	huaxinan [huaxinan electronics co.,ltd], slim type and small occupying area can offer high density p.c.b. techniqu
jqx-141ff2as10adc30.543.3	реле switching capacity from 10a 16
jqx-141ff2as10adc50.543.3	реле switching capacity from 10a 16
jqx-141ff2as10adc60.543.3	реле switching capacity from 10a 16
jqx-141ff2as10adc90.543.3	реле switching capacity from 10a 16
jqx-141ff2as16adc30.543.3	реле switching capacity from 10a 16
jqx-141ff2as16adc50.543.3	реле switching capacity from 10a 16
jqx-141ff2as16adc60.543.3	реле switching capacity from 10a 16
jqx-141ff2as16adc90.543.3	реле switching capacity from 10a 16
jqx-141ff2as5adc120.543.3	реле switching capacity from 10a 16
jqx-141ff2as5adc30.543.3	реле switching capacity from 10a 16

jqx-141ff2as5adc50.543.3	реле switching capacity from 10a 16
jqx-141ff2as5adc60.543.3	реле switching capacity from 10a 16
jqx-141ff2as5adc90.543.3	реле switching capacity from 10a 16
jqx-141ff2as8adc120.543.3	реле switching capacity from 10a 16
jqx-141ff2as8adc30.543.3	реле switching capacity from 10a 16
jqx-141ff2as8adc50.543.3	реле switching capacity from 10a 16
jqx-141ff2as8adc60.543.3	реле switching capacity from 10a 16
jqx-141ff2as8adc90.543.3	реле switching capacity from 10a 16
jqx-141ff2az10adc30.543.3	реле switching capacity from 10a 16
jqx-141ff2az10adc50.543.3	реле switching capacity from 10a 16
jqx-141ff2az10adc60.543.3	реле switching capacity from 10a 16
jqx-141ff2az10adc90.543.3	реле switching capacity from 10a 16
jqx-141ff2az16adc30.543.3	реле switching capacity from 10a 16
jqx-141ff2az16adc50.543.3	реле switching capacity from 10a 16
jqx-141ff2az16adc60.543.3	реле switching capacity from 10a 16
jqx-141ff2az16adc90.543.3	реле switching capacity from 10a 16
jqx-141ff2az5adc120.543.3	реле switching capacity from 10a 16
jqx-141ff2az5adc30.543.3	реле switching capacity from 10a 16
jqx-141ff2az5adc50.543.3	реле switching capacity from 10a 16
jqx-141ff2az5adc60.543.3	реле switching capacity from 10a 16
jqx-141ff2az5adc90.543.3	реле switching capacity from 10a 16
jqx-141ff2az8adc120.543.3	реле switching capacity from 10a 16
jqx-141ff2az8adc30.543.3	реле switching capacity from 10a 16
jqx-141ff2az8adc50.543.3	реле switching capacity from 10a 16
jqx-141ff2az8adc60.543.3	реле switching capacity from 10a 16
jqx-141ff2az8adc90.543.3	реле switching capacity from 10a 16

jqx-141ff2c huaxinan [huaxinan electronics co.,ltd], slim type and small occupying area can offer high density p.c.b. techniqu

jqx-141ff2cs10adc30.543.3	реле switching capacity from 10a 16
---------------------------	-------------------------------------

jqx-141ff2cs10adc50.543.3	реле switching capacity from 10a 16
jqx-141ff2cs10adc60.543.3	реле switching capacity from 10a 16
jqx-141ff2cs10adc90.543.3	реле switching capacity from 10a 16
jqx-141ff2cs16adc30.543.3	реле switching capacity from 10a 16
jqx-141ff2cs16adc50.543.3	реле switching capacity from 10a 16
jqx-141ff2cs16adc60.543.3	реле switching capacity from 10a 16
jqx-141ff2cs16adc90.543.3	реле switching capacity from 10a 16
jqx-141ff2cs5adc120.543.3	реле switching capacity from 10a 16
jqx-141ff2cs5adc30.543.3	реле switching capacity from 10a 16
jqx-141ff2cs5adc50.543.3	реле switching capacity from 10a 16
jqx-141ff2cs5adc60.543.3	реле switching capacity from 10a 16
jqx-141ff2cs5adc90.543.3	реле switching capacity from 10a 16
jqx-141ff2cs8adc120.543.3	реле switching capacity from 10a 16
jqx-141ff2cs8adc30.543.3	реле switching capacity from 10a 16
jqx-141ff2cs8adc50.543.3	реле switching capacity from 10a 16
jqx-141ff2cs8adc60.543.3	реле switching capacity from 10a 16
jqx-141ff2cs8adc90.543.3	реле switching capacity from 10a 16
jqx-141ff2cz10adc30.543.3	реле switching capacity from 10a 16
jqx-141ff2cz10adc50.543.3	реле switching capacity from 10a 16
jqx-141ff2cz10adc60.543.3	реле switching capacity from 10a 16
jqx-141ff2cz10adc90.543.3	реле switching capacity from 10a 16
jqx-141ff2cz16adc30.543.3	реле switching capacity from 10a 16
jqx-141ff2cz16adc50.543.3	реле switching capacity from 10a 16
jqx-141ff2cz16adc60.543.3	реле switching capacity from 10a 16
jqx-141ff2cz16adc90.543.3	реле switching capacity from 10a 16
jqx-141ff2cz5adc120.543.3	реле switching capacity from 10a 16
jqx-141ff2cz5adc30.543.3	реле switching capacity from 10a 16
jqx-141ff2cz5adc50.543.3	реле switching capacity from 10a 16

jqx-141ff2cz5adc60.543.3 реле switching capacity from 10a 16

jqx-141ff2cz5adc90.543.3 реле switching capacity from 10a 16

jqx-141ff2cz8adc120.543.3 реле switching capacity from 10a 16

jqx-141ff2cz8adc30.543.3 реле switching capacity from 10a 16

jqx-141ff2cz8adc50.543.3 реле switching capacity from 10a 16

jqx-141ff2cz8adc60.543.3 реле switching capacity from 10a 16

jqx-141ff2cz8adc90.543.3 реле switching capacity from 10a 16

jqx-14f-w012-z glenair

jqx-14fc huaxinan [huaxinan electronics co.,ltd], electronic component

jqx-14fc-2c-12v группа: реле, описание: тип контактов: 2с; икатушки: 12в; , габариты: 29х12,8х26мм

jqx-14fc-2c-12v

jqx-14fc-2c-24v

jqx-14fc-2c-24v группа: реле, описание: тип контактов: 2с; икатушки: 24в; , габариты: 29х12,8х26мм

jqx-14fc1 ningbo forward relay corporation

jqx-14fc12as10 реле

jqx-14fc12as16 реле

jqx-14fc12as20 реле

jqx-14fc12as3 реле

jqx-14fc12as5 реле

jqx-14fc12as6 реле

jqx-14fc12as8 реле

jqx-14fc12az10 реле

jqx-14fc12az16 реле

jqx-14fc12az20 реле

jqx-14fc12az3 реле

jqx-14fc12az5 реле

jqx-14fc12az6 реле

jqx-14fc12az8 реле

jqx-14fc12cs10 реле
jqx-14fc12cs16 реле
jqx-14fc12cs20 реле
jqx-14fc12cs3 реле
jqx-14fc12cs5 реле
jqx-14fc12cs6 реле
jqx-14fc12cs8 реле
jqx-14fc12cz10 реле
jqx-14fc12cz16 реле
jqx-14fc12cz20 реле
jqx-14fc12cz3 реле
jqx-14fc12cz5 реле
jqx-14fc12cz6 реле
jqx-14fc12cz8 реле
jqx-14fc1as10 реле
jqx-14fc1as16 реле
jqx-14fc1as20 реле
jqx-14fc1as3 реле
jqx-14fc1as5 реле
jqx-14fc1as6 реле
jqx-14fc1as8 реле
jqx-14fc1az10 реле
jqx-14fc1az16 реле
jqx-14fc1az20 реле
jqx-14fc1az3 реле
jqx-14fc1az5 реле
jqx-14fc1az6 реле
jqx-14fc1az8 реле

jqx-14fc1cs10 реле
jqx-14fc1cs16 реле
jqx-14fc1cs16dc12v5.0 ningbo forward relay corporation ltd
jqx-14fc1cs20 реле
jqx-14fc1cs3 реле
jqx-14fc1cs5 реле
jqx-14fc1cs6 реле
jqx-14fc1cs8 реле
jqx-14fc1cz10 реле
jqx-14fc1cz16 реле
jqx-14fc1cz20 реле
jqx-14fc1cz3 реле
jqx-14fc1cz5 реле
jqx-14fc1cz6 реле
jqx-14fc1cz8 реле
jqx-14fc2 ningbo forward relay corporation
jqx-14fc22as10 реле
jqx-14fc22as16 реле
jqx-14fc22as20 реле
jqx-14fc22as3 реле
jqx-14fc22as5 реле
jqx-14fc22as6 реле
jqx-14fc22as8 реле
jqx-14fc22az10 реле
jqx-14fc22az16 реле
jqx-14fc22az20 реле
jqx-14fc22az3 реле
jqx-14fc22az5 реле

jqx-14fc22az6 реле
jqx-14fc22az8 реле
jqx-14fc22cs10 реле
jqx-14fc22cs16 реле
jqx-14fc22cs20 реле
jqx-14fc22cs3 реле
jqx-14fc22cs5 реле
jqx-14fc22cs6 реле
jqx-14fc22cs8 реле
jqx-14fc22cz10 реле
jqx-14fc22cz16 реле
jqx-14fc22cz20 реле
jqx-14fc22cz3 реле
jqx-14fc22cz5 реле
jqx-14fc22cz6 реле
jqx-14fc22cz8 реле
jqx-14fc2a huaxinan [huaxinan electronics co.,ltd], heavy load, suitable for heavy power reverse
jqx-14fc2as10 реле
jqx-14fc2as10aac120.83.5 реле
jqx-14fc2as10aac120.85 реле
jqx-14fc2as10aac121.23.5 реле
jqx-14fc2as10aac121.25 реле
jqx-14fc2as10aac1213.5 реле
jqx-14fc2as10aac1215 реле
jqx-14fc2as10aac12nil3.5 реле
jqx-14fc2as10aac12nil5 реле
jqx-14fc2as10aac240.83.5 реле
jqx-14fc2as10aac240.85 реле

jqx-14fc2as10aac241.23.5	реле
jqx-14fc2as10aac241.25	реле
jqx-14fc2as10aac2413.5	реле
jqx-14fc2as10aac2415	реле
jqx-14fc2as10aac24nil3.5	реле
jqx-14fc2as10aac24nil5	реле
jqx-14fc2as10aac60.83.5	реле
jqx-14fc2as10aac60.85	реле
jqx-14fc2as10aac61.23.5	реле
jqx-14fc2as10aac61.25	реле
jqx-14fc2as10aac613.5	реле
jqx-14fc2as10aac615	реле
jqx-14fc2as10aac6nil3.5	реле
jqx-14fc2as10aac6nil5	реле
jqx-14fc2as10adc120.83.5	реле
jqx-14fc2as10adc120.85	реле
jqx-14fc2as10adc121.23.5	реле
jqx-14fc2as10adc121.25	реле
jqx-14fc2as10adc1213.5	реле
jqx-14fc2as10adc1215	реле
jqx-14fc2as10adc12nil3.5	реле
jqx-14fc2as10adc12nil5	реле
jqx-14fc2as10adc240.83.5	реле
jqx-14fc2as10adc240.85	реле
jqx-14fc2as10adc241.23.5	реле
jqx-14fc2as10adc241.25	реле
jqx-14fc2as10adc2413.5	реле
jqx-14fc2as10adc2415	реле

jqx-14fc2as10adc24nil3.5 реле
jqx-14fc2as10adc24nil5 реле
jqx-14fc2as10adc60.83.5 реле
jqx-14fc2as10adc60.85 реле
jqx-14fc2as10adc61.23.5 реле
jqx-14fc2as10adc61.25 реле
jqx-14fc2as10adc613.5 реле
jqx-14fc2as10adc615 реле
jqx-14fc2as10adc6nil3.5 реле
jqx-14fc2as10adc6nil5 реле
jqx-14fc2as16 реле
jqx-14fc2as20 реле
jqx-14fc2as20aac120.83.5 реле
jqx-14fc2as20aac120.85 реле
jqx-14fc2as20aac121.23.5 реле
jqx-14fc2as20aac121.25 реле
jqx-14fc2as20aac1213.5 реле
jqx-14fc2as20aac1215 реле
jqx-14fc2as20aac12nil3.5 реле
jqx-14fc2as20aac12nil5 реле
jqx-14fc2as20aac240.83.5 реле
jqx-14fc2as20aac240.85 реле
jqx-14fc2as20aac241.23.5 реле
jqx-14fc2as20aac241.25 реле
jqx-14fc2as20aac2413.5 реле
jqx-14fc2as20aac2415 реле
jqx-14fc2as20aac24nil3.5 реле
jqx-14fc2as20aac24nil5 реле

jqx-14fc2as20aac60.83.5	реле
jqx-14fc2as20aac60.85	реле
jqx-14fc2as20aac61.23.5	реле
jqx-14fc2as20aac61.25	реле
jqx-14fc2as20aac613.5	реле
jqx-14fc2as20aac615	реле
jqx-14fc2as20aac6nil3.5	реле
jqx-14fc2as20aac6nil5	реле
jqx-14fc2as20adc120.83.5	реле
jqx-14fc2as20adc120.85	реле
jqx-14fc2as20adc121.23.5	реле
jqx-14fc2as20adc121.25	реле
jqx-14fc2as20adc1213.5	реле
jqx-14fc2as20adc1215	реле
jqx-14fc2as20adc12nil3.5	реле
jqx-14fc2as20adc12nil5	реле
jqx-14fc2as20adc240.83.5	реле
jqx-14fc2as20adc240.85	реле
jqx-14fc2as20adc241.23.5	реле
jqx-14fc2as20adc241.25	реле
jqx-14fc2as20adc2413.5	реле
jqx-14fc2as20adc2415	реле
jqx-14fc2as20adc24nil3.5	реле
jqx-14fc2as20adc24nil5	реле
jqx-14fc2as20adc60.83.5	реле
jqx-14fc2as20adc60.85	реле
jqx-14fc2as20adc61.23.5	реле
jqx-14fc2as20adc61.25	реле

jqx-14fc2as20adc613.5 реле
jqx-14fc2as20adc615 реле
jqx-14fc2as20adc6nil3.5 реле
jqx-14fc2as20adc6nil5 реле
jqx-14fc2as3 реле
jqx-14fc2as3aac120.83.5 реле
jqx-14fc2as3aac120.85 реле
jqx-14fc2as3aac121.23.5 реле
jqx-14fc2as3aac121.25 реле
jqx-14fc2as3aac1213.5 реле
jqx-14fc2as3aac1215 реле
jqx-14fc2as3aac12nil3.5 реле
jqx-14fc2as3aac12nil5 реле
jqx-14fc2as3aac240.83.5 реле
jqx-14fc2as3aac240.85 реле
jqx-14fc2as3aac241.23.5 реле
jqx-14fc2as3aac241.25 реле
jqx-14fc2as3aac2413.5 реле
jqx-14fc2as3aac2415 реле
jqx-14fc2as3aac24nil3.5 реле
jqx-14fc2as3aac24nil5 реле
jqx-14fc2as3aac60.83.5 реле
jqx-14fc2as3aac60.85 реле
jqx-14fc2as3aac61.23.5 реле
jqx-14fc2as3aac61.25 реле
jqx-14fc2as3aac613.5 реле
jqx-14fc2as3aac615 реле
jqx-14fc2as3aac6nil3.5 реле

jqx-14fc2as3aac6nil5 реле
jqx-14fc2as3adc120.83.5 реле
jqx-14fc2as3adc120.85 реле
jqx-14fc2as3adc121.23.5 реле
jqx-14fc2as3adc121.25 реле
jqx-14fc2as3adc1213.5 реле
jqx-14fc2as3adc1215 реле
jqx-14fc2as3adc12nil3.5 реле
jqx-14fc2as3adc12nil5 реле
jqx-14fc2as3adc240.83.5 реле
jqx-14fc2as3adc240.85 реле
jqx-14fc2as3adc241.23.5 реле
jqx-14fc2as3adc241.25 реле
jqx-14fc2as3adc2413.5 реле
jqx-14fc2as3adc2415 реле
jqx-14fc2as3adc24nil3.5 реле
jqx-14fc2as3adc24nil5 реле
jqx-14fc2as3adc60.83.5 реле
jqx-14fc2as3adc60.85 реле
jqx-14fc2as3adc61.23.5 реле
jqx-14fc2as3adc61.25 реле
jqx-14fc2as3adc613.5 реле
jqx-14fc2as3adc615 реле
jqx-14fc2as3adc6nil3.5 реле
jqx-14fc2as3adc6nil5 реле
jqx-14fc2as5 реле
jqx-14fc2as5aac120.83.5 реле
jqx-14fc2as5aac120.85 реле

jqx-14fc2as5aac121.23.5 реле
jqx-14fc2as5aac121.25 реле
jqx-14fc2as5aac1213.5 реле
jqx-14fc2as5aac1215 реле
jqx-14fc2as5aac12nil3.5 реле
jqx-14fc2as5aac12nil5 реле
jqx-14fc2as5aac240.83.5 реле
jqx-14fc2as5aac240.85 реле
jqx-14fc2as5aac241.23.5 реле
jqx-14fc2as5aac241.25 реле
jqx-14fc2as5aac2413.5 реле
jqx-14fc2as5aac2415 реле
jqx-14fc2as5aac24nil3.5 реле
jqx-14fc2as5aac24nil5 реле
jqx-14fc2as5aac60.83.5 реле
jqx-14fc2as5aac60.85 реле
jqx-14fc2as5aac61.23.5 реле
jqx-14fc2as5aac61.25 реле
jqx-14fc2as5aac613.5 реле
jqx-14fc2as5aac615 реле
jqx-14fc2as5aac6nil3.5 реле
jqx-14fc2as5aac6nil5 реле
jqx-14fc2as5adc120.83.5 реле
jqx-14fc2as5adc120.85 реле
jqx-14fc2as5adc121.23.5 реле
jqx-14fc2as5adc121.25 реле
jqx-14fc2as5adc1213.5 реле
jqx-14fc2as5adc1215 реле

jqx-14fc2as5adc12nil3.5 реле
jqx-14fc2as5adc12nil5 реле
jqx-14fc2as5adc240.83.5 реле
jqx-14fc2as5adc240.85 реле
jqx-14fc2as5adc241.23.5 реле
jqx-14fc2as5adc241.25 реле
jqx-14fc2as5adc2413.5 реле
jqx-14fc2as5adc2415 реле
jqx-14fc2as5adc24nil3.5 реле
jqx-14fc2as5adc24nil5 реле
jqx-14fc2as5adc60.83.5 реле
jqx-14fc2as5adc60.85 реле
jqx-14fc2as5adc61.23.5 реле
jqx-14fc2as5adc61.25 реле
jqx-14fc2as5adc613.5 реле
jqx-14fc2as5adc615 реле
jqx-14fc2as5adc6nil3.5 реле
jqx-14fc2as5adc6nil5 реле
jqx-14fc2as6 реле
jqx-14fc2as6aac120.83.5 реле
jqx-14fc2as6aac120.85 реле
jqx-14fc2as6aac121.23.5 реле
jqx-14fc2as6aac121.25 реле
jqx-14fc2as6aac1213.5 реле
jqx-14fc2as6aac1215 реле
jqx-14fc2as6aac12nil3.5 реле
jqx-14fc2as6aac12nil5 реле
jqx-14fc2as6aac240.83.5 реле

jqx-14fc2as6aac240.85 реле
jqx-14fc2as6aac241.23.5 реле
jqx-14fc2as6aac241.25 реле
jqx-14fc2as6aac2413.5 реле
jqx-14fc2as6aac2415 реле
jqx-14fc2as6aac24nil3.5 реле
jqx-14fc2as6aac24nil5 реле
jqx-14fc2as6aac60.83.5 реле
jqx-14fc2as6aac60.85 реле
jqx-14fc2as6aac61.23.5 реле
jqx-14fc2as6aac61.25 реле
jqx-14fc2as6aac613.5 реле
jqx-14fc2as6aac615 реле
jqx-14fc2as6aac6nil3.5 реле
jqx-14fc2as6aac6nil5 реле
jqx-14fc2as6adc120.83.5 реле
jqx-14fc2as6adc120.85 реле
jqx-14fc2as6adc121.23.5 реле
jqx-14fc2as6adc121.25 реле
jqx-14fc2as6adc1213.5 реле
jqx-14fc2as6adc1215 реле
jqx-14fc2as6adc12nil3.5 реле
jqx-14fc2as6adc12nil5 реле
jqx-14fc2as6adc240.83.5 реле
jqx-14fc2as6adc240.85 реле
jqx-14fc2as6adc241.23.5 реле
jqx-14fc2as6adc241.25 реле
jqx-14fc2as6adc2413.5 реле

jqx-14fc2as6adc2415 реле
jqx-14fc2as6adc24nil3.5 реле
jqx-14fc2as6adc24nil5 реле
jqx-14fc2as6adc60.83.5 реле
jqx-14fc2as6adc60.85 реле
jqx-14fc2as6adc61.23.5 реле
jqx-14fc2as6adc61.25 реле
jqx-14fc2as6adc613.5 реле
jqx-14fc2as6adc615 реле
jqx-14fc2as6adc6nil3.5 реле
jqx-14fc2as6adc6nil5 реле
jqx-14fc2as8 реле
jqx-14fc2az10 реле
jqx-14fc2az10aac120.83.5 реле
jqx-14fc2az10aac120.85 реле
jqx-14fc2az10aac121.23.5 реле
jqx-14fc2az10aac121.25 реле
jqx-14fc2az10aac1213.5 реле
jqx-14fc2az10aac1215 реле
jqx-14fc2az10aac12nil3.5 реле
jqx-14fc2az10aac12nil5 реле
jqx-14fc2az10aac240.83.5 реле
jqx-14fc2az10aac240.85 реле
jqx-14fc2az10aac241.23.5 реле
jqx-14fc2az10aac241.25 реле
jqx-14fc2az10aac2413.5 реле
jqx-14fc2az10aac2415 реле
jqx-14fc2az10aac24nil3.5 реле

jqx-14fc2az10aac24nil5 реле
jqx-14fc2az10aac60.83.5 реле
jqx-14fc2az10aac60.85 реле
jqx-14fc2az10aac61.23.5 реле
jqx-14fc2az10aac61.25 реле
jqx-14fc2az10aac613.5 реле
jqx-14fc2az10aac615 реле
jqx-14fc2az10aac6nil3.5 реле
jqx-14fc2az10aac6nil5 реле
jqx-14fc2az10adc120.83.5 реле
jqx-14fc2az10adc120.85 реле
jqx-14fc2az10adc121.23.5 реле
jqx-14fc2az10adc121.25 реле
jqx-14fc2az10adc1213.5 реле
jqx-14fc2az10adc1215 реле
jqx-14fc2az10adc12nil3.5 реле
jqx-14fc2az10adc12nil5 реле
jqx-14fc2az10adc240.83.5 реле
jqx-14fc2az10adc240.85 реле
jqx-14fc2az10adc241.23.5 реле
jqx-14fc2az10adc241.25 реле
jqx-14fc2az10adc2413.5 реле
jqx-14fc2az10adc2415 реле
jqx-14fc2az10adc24nil3.5 реле
jqx-14fc2az10adc24nil5 реле
jqx-14fc2az10adc60.83.5 реле
jqx-14fc2az10adc60.85 реле
jqx-14fc2az10adc61.23.5 реле

jqx-14fc2az10adc61.25 реле
jqx-14fc2az10adc613.5 реле
jqx-14fc2az10adc615 реле
jqx-14fc2az10adc6nil3.5 реле
jqx-14fc2az10adc6nil5 реле
jqx-14fc2az16 реле
jqx-14fc2az20 реле
jqx-14fc2az20aac120.83.5 реле
jqx-14fc2az20aac120.85 реле
jqx-14fc2az20aac121.23.5 реле
jqx-14fc2az20aac121.25 реле
jqx-14fc2az20aac1213.5 реле
jqx-14fc2az20aac1215 реле
jqx-14fc2az20aac12nil3.5 реле
jqx-14fc2az20aac12nil5 реле
jqx-14fc2az20aac240.83.5 реле
jqx-14fc2az20aac240.85 реле
jqx-14fc2az20aac241.23.5 реле
jqx-14fc2az20aac241.25 реле
jqx-14fc2az20aac2413.5 реле
jqx-14fc2az20aac2415 реле
jqx-14fc2az20aac24nil3.5 реле
jqx-14fc2az20aac24nil5 реле
jqx-14fc2az20aac60.83.5 реле
jqx-14fc2az20aac60.85 реле
jqx-14fc2az20aac61.23.5 реле
jqx-14fc2az20aac61.25 реле
jqx-14fc2az20aac613.5 реле

jqx-14fc2az20aac615 реле
jqx-14fc2az20aac6nil3.5 реле
jqx-14fc2az20aac6nil5 реле
jqx-14fc2az20adc120.83.5 реле
jqx-14fc2az20adc120.85 реле
jqx-14fc2az20adc121.23.5 реле
jqx-14fc2az20adc121.25 реле
jqx-14fc2az20adc1213.5 реле
jqx-14fc2az20adc1215 реле
jqx-14fc2az20adc12nil3.5 реле
jqx-14fc2az20adc12nil5 реле
jqx-14fc2az20adc240.83.5 реле
jqx-14fc2az20adc240.85 реле
jqx-14fc2az20adc241.23.5 реле
jqx-14fc2az20adc241.25 реле
jqx-14fc2az20adc2413.5 реле
jqx-14fc2az20adc2415 реле
jqx-14fc2az20adc24nil3.5 реле
jqx-14fc2az20adc24nil5 реле
jqx-14fc2az20adc60.83.5 реле
jqx-14fc2az20adc60.85 реле
jqx-14fc2az20adc61.23.5 реле
jqx-14fc2az20adc61.25 реле
jqx-14fc2az20adc613.5 реле
jqx-14fc2az20adc615 реле
jqx-14fc2az20adc6nil3.5 реле
jqx-14fc2az20adc6nil5 реле
jqx-14fc2az3 реле

jqx-14fc2az3aac120.83.5 реле
jqx-14fc2az3aac120.85 реле
jqx-14fc2az3aac121.23.5 реле
jqx-14fc2az3aac121.25 реле
jqx-14fc2az3aac1213.5 реле
jqx-14fc2az3aac1215 реле
jqx-14fc2az3aac12nil3.5 реле
jqx-14fc2az3aac12nil5 реле
jqx-14fc2az3aac240.83.5 реле
jqx-14fc2az3aac240.85 реле
jqx-14fc2az3aac241.23.5 реле
jqx-14fc2az3aac241.25 реле
jqx-14fc2az3aac2413.5 реле
jqx-14fc2az3aac2415 реле
jqx-14fc2az3aac24nil3.5 реле
jqx-14fc2az3aac24nil5 реле
jqx-14fc2az3aac60.83.5 реле
jqx-14fc2az3aac60.85 реле
jqx-14fc2az3aac61.23.5 реле
jqx-14fc2az3aac61.25 реле
jqx-14fc2az3aac613.5 реле
jqx-14fc2az3aac615 реле
jqx-14fc2az3aac6nil3.5 реле
jqx-14fc2az3aac6nil5 реле
jqx-14fc2az3adc120.83.5 реле
jqx-14fc2az3adc120.85 реле
jqx-14fc2az3adc121.23.5 реле
jqx-14fc2az3adc121.25 реле

jqx-14fc2az3adc1213.5 реле
jqx-14fc2az3adc1215 реле
jqx-14fc2az3adc12nil3.5 реле
jqx-14fc2az3adc12nil5 реле
jqx-14fc2az3adc240.83.5 реле
jqx-14fc2az3adc240.85 реле
jqx-14fc2az3adc241.23.5 реле
jqx-14fc2az3adc241.25 реле
jqx-14fc2az3adc2413.5 реле
jqx-14fc2az3adc2415 реле
jqx-14fc2az3adc24nil3.5 реле
jqx-14fc2az3adc24nil5 реле
jqx-14fc2az3adc60.83.5 реле
jqx-14fc2az3adc60.85 реле
jqx-14fc2az3adc61.23.5 реле
jqx-14fc2az3adc61.25 реле
jqx-14fc2az3adc613.5 реле
jqx-14fc2az3adc615 реле
jqx-14fc2az3adc6nil3.5 реле
jqx-14fc2az3adc6nil5 реле
jqx-14fc2az5 реле
jqx-14fc2az5aac120.83.5 реле
jqx-14fc2az5aac120.85 реле
jqx-14fc2az5aac121.23.5 реле
jqx-14fc2az5aac121.25 реле
jqx-14fc2az5aac1213.5 реле
jqx-14fc2az5aac1215 реле
jqx-14fc2az5aac12nil3.5 реле

jqx-14fc2az5aac12nil5 реле
jqx-14fc2az5aac240.83.5 реле
jqx-14fc2az5aac240.85 реле
jqx-14fc2az5aac241.23.5 реле
jqx-14fc2az5aac241.25 реле
jqx-14fc2az5aac2413.5 реле
jqx-14fc2az5aac2415 реле
jqx-14fc2az5aac24nil3.5 реле
jqx-14fc2az5aac24nil5 реле
jqx-14fc2az5aac60.83.5 реле
jqx-14fc2az5aac60.85 реле
jqx-14fc2az5aac61.23.5 реле
jqx-14fc2az5aac61.25 реле
jqx-14fc2az5aac613.5 реле
jqx-14fc2az5aac615 реле
jqx-14fc2az5aac6nil3.5 реле
jqx-14fc2az5aac6nil5 реле
jqx-14fc2az5adc120.83.5 реле
jqx-14fc2az5adc120.85 реле
jqx-14fc2az5adc121.23.5 реле
jqx-14fc2az5adc121.25 реле
jqx-14fc2az5adc1213.5 реле
jqx-14fc2az5adc1215 реле
jqx-14fc2az5adc12nil3.5 реле
jqx-14fc2az5adc12nil5 реле
jqx-14fc2az5adc240.83.5 реле
jqx-14fc2az5adc240.85 реле
jqx-14fc2az5adc241.23.5 реле

jqx-14fc2az5adc241.25 реле
jqx-14fc2az5adc2413.5 реле
jqx-14fc2az5adc2415 реле
jqx-14fc2az5adc24nil3.5 реле
jqx-14fc2az5adc24nil5 реле
jqx-14fc2az5adc60.83.5 реле
jqx-14fc2az5adc60.85 реле
jqx-14fc2az5adc61.23.5 реле
jqx-14fc2az5adc61.25 реле
jqx-14fc2az5adc613.5 реле
jqx-14fc2az5adc615 реле
jqx-14fc2az5adc6nil3.5 реле
jqx-14fc2az5adc6nil5 реле
jqx-14fc2az6 реле
jqx-14fc2az6aac120.83.5 реле
jqx-14fc2az6aac120.85 реле
jqx-14fc2az6aac121.23.5 реле
jqx-14fc2az6aac121.25 реле
jqx-14fc2az6aac1213.5 реле
jqx-14fc2az6aac1215 реле
jqx-14fc2az6aac12nil3.5 реле
jqx-14fc2az6aac12nil5 реле
jqx-14fc2az6aac240.83.5 реле
jqx-14fc2az6aac240.85 реле
jqx-14fc2az6aac241.23.5 реле
jqx-14fc2az6aac241.25 реле
jqx-14fc2az6aac2413.5 реле
jqx-14fc2az6aac2415 реле

jqx-14fc2az6aac24nil3.5 реле
jqx-14fc2az6aac24nil5 реле
jqx-14fc2az6aac60.83.5 реле
jqx-14fc2az6aac60.85 реле
jqx-14fc2az6aac61.23.5 реле
jqx-14fc2az6aac61.25 реле
jqx-14fc2az6aac613.5 реле
jqx-14fc2az6aac615 реле
jqx-14fc2az6aac6nil3.5 реле
jqx-14fc2az6aac6nil5 реле
jqx-14fc2az6adc120.83.5 реле
jqx-14fc2az6adc120.85 реле
jqx-14fc2az6adc121.23.5 реле
jqx-14fc2az6adc121.25 реле
jqx-14fc2az6adc1213.5 реле
jqx-14fc2az6adc1215 реле
jqx-14fc2az6adc12nil3.5 реле
jqx-14fc2az6adc12nil5 реле
jqx-14fc2az6adc240.83.5 реле
jqx-14fc2az6adc240.85 реле
jqx-14fc2az6adc241.23.5 реле
jqx-14fc2az6adc241.25 реле
jqx-14fc2az6adc2413.5 реле
jqx-14fc2az6adc2415 реле
jqx-14fc2az6adc24nil3.5 реле
jqx-14fc2az6adc24nil5 реле
jqx-14fc2az6adc60.83.5 реле
jqx-14fc2az6adc60.85 реле

jqx-14fc2az6adc61.23.5 реле
jqx-14fc2az6adc61.25 реле
jqx-14fc2az6adc613.5 реле
jqx-14fc2az6adc615 реле
jqx-14fc2az6adc6nil3.5 реле
jqx-14fc2az6adc6nil5 реле
jqx-14fc2az8 реле
jqx-14fc2c huaxinan [huaxinan electronics co.,ltd], heavy load, suitable for heavy power revers
jqx-14fc2cs10 реле
jqx-14fc2cs10aac120.83.5 реле
jqx-14fc2cs10aac120.85 реле
jqx-14fc2cs10aac121.23.5 реле
jqx-14fc2cs10aac121.25 реле
jqx-14fc2cs10aac1213.5 реле
jqx-14fc2cs10aac1215 реле
jqx-14fc2cs10aac12nil3.5 реле
jqx-14fc2cs10aac12nil5 реле
jqx-14fc2cs10aac240.83.5 реле
jqx-14fc2cs10aac240.85 реле
jqx-14fc2cs10aac241.23.5 реле
jqx-14fc2cs10aac241.25 реле
jqx-14fc2cs10aac2413.5 реле
jqx-14fc2cs10aac2415 реле
jqx-14fc2cs10aac24nil3.5 реле
jqx-14fc2cs10aac24nil5 реле
jqx-14fc2cs10aac60.83.5 реле
jqx-14fc2cs10aac60.85 реле
jqx-14fc2cs10aac61.23.5 реле

jqx-14fc2cs10aac61.25 реле
jqx-14fc2cs10aac613.5 реле
jqx-14fc2cs10aac615 реле
jqx-14fc2cs10aac6nil3.5 реле
jqx-14fc2cs10aac6nil5 реле
jqx-14fc2cs10adc120.83.5 реле
jqx-14fc2cs10adc120.85 реле
jqx-14fc2cs10adc121.23.5 реле
jqx-14fc2cs10adc121.25 реле
jqx-14fc2cs10adc1213.5 реле
jqx-14fc2cs10adc1215 реле
jqx-14fc2cs10adc12nil3.5 реле
jqx-14fc2cs10adc12nil5 реле
jqx-14fc2cs10adc240.83.5 реле
jqx-14fc2cs10adc240.85 реле
jqx-14fc2cs10adc241.23.5 реле
jqx-14fc2cs10adc241.25 реле
jqx-14fc2cs10adc2413.5 реле
jqx-14fc2cs10adc2415 реле
jqx-14fc2cs10adc24nil3.5 реле
jqx-14fc2cs10adc24nil5 реле
jqx-14fc2cs10adc60.83.5 реле
jqx-14fc2cs10adc60.85 реле
jqx-14fc2cs10adc61.23.5 реле
jqx-14fc2cs10adc61.25 реле
jqx-14fc2cs10adc613.5 реле
jqx-14fc2cs10adc615 реле
jqx-14fc2cs10adc6nil3.5 реле

jqx-14fc2cs10adc6nil5 реле
jqx-14fc2cs16 реле
jqx-14fc2cs20 реле
jqx-14fc2cs20aac120.83.5 реле
jqx-14fc2cs20aac120.85 реле
jqx-14fc2cs20aac121.23.5 реле
jqx-14fc2cs20aac121.25 реле
jqx-14fc2cs20aac1213.5 реле
jqx-14fc2cs20aac1215 реле
jqx-14fc2cs20aac12nil3.5 реле
jqx-14fc2cs20aac12nil5 реле
jqx-14fc2cs20aac240.83.5 реле
jqx-14fc2cs20aac240.85 реле
jqx-14fc2cs20aac241.23.5 реле
jqx-14fc2cs20aac241.25 реле
jqx-14fc2cs20aac2413.5 реле
jqx-14fc2cs20aac2415 реле
jqx-14fc2cs20aac24nil3.5 реле
jqx-14fc2cs20aac24nil5 реле
jqx-14fc2cs20aac60.83.5 реле
jqx-14fc2cs20aac60.85 реле
jqx-14fc2cs20aac61.23.5 реле
jqx-14fc2cs20aac61.25 реле
jqx-14fc2cs20aac613.5 реле
jqx-14fc2cs20aac615 реле
jqx-14fc2cs20aac6nil3.5 реле
jqx-14fc2cs20aac6nil5 реле
jqx-14fc2cs20adc120.83.5 реле

jqx-14fc2cs20adc120.85	реле
jqx-14fc2cs20adc121.23.5	реле
jqx-14fc2cs20adc121.25	реле
jqx-14fc2cs20adc1213.5	реле
jqx-14fc2cs20adc1215	реле
jqx-14fc2cs20adc12nil3.5	реле
jqx-14fc2cs20adc12nil5	реле
jqx-14fc2cs20adc240.83.5	реле
jqx-14fc2cs20adc240.85	реле
jqx-14fc2cs20adc241.23.5	реле
jqx-14fc2cs20adc241.25	реле
jqx-14fc2cs20adc2413.5	реле
jqx-14fc2cs20adc2415	реле
jqx-14fc2cs20adc24nil3.5	реле
jqx-14fc2cs20adc24nil5	реле
jqx-14fc2cs20adc60.83.5	реле
jqx-14fc2cs20adc60.85	реле
jqx-14fc2cs20adc61.23.5	реле
jqx-14fc2cs20adc61.25	реле
jqx-14fc2cs20adc613.5	реле
jqx-14fc2cs20adc615	реле
jqx-14fc2cs20adc6nil3.5	реле
jqx-14fc2cs20adc6nil5	реле
jqx-14fc2cs3	реле
jqx-14fc2cs3aac120.83.5	реле
jqx-14fc2cs3aac120.85	реле
jqx-14fc2cs3aac121.23.5	реле
jqx-14fc2cs3aac121.25	реле

jqx-14fc2cs3aac1213.5 реле
jqx-14fc2cs3aac1215 реле
jqx-14fc2cs3aac12nil3.5 реле
jqx-14fc2cs3aac12nil5 реле
jqx-14fc2cs3aac240.83.5 реле
jqx-14fc2cs3aac240.85 реле
jqx-14fc2cs3aac241.23.5 реле
jqx-14fc2cs3aac241.25 реле
jqx-14fc2cs3aac2413.5 реле
jqx-14fc2cs3aac2415 реле
jqx-14fc2cs3aac24nil3.5 реле
jqx-14fc2cs3aac24nil5 реле
jqx-14fc2cs3aac60.83.5 реле
jqx-14fc2cs3aac60.85 реле
jqx-14fc2cs3aac61.23.5 реле
jqx-14fc2cs3aac61.25 реле
jqx-14fc2cs3aac613.5 реле
jqx-14fc2cs3aac615 реле
jqx-14fc2cs3aac6nil3.5 реле
jqx-14fc2cs3aac6nil5 реле
jqx-14fc2cs3adc120.83.5 реле
jqx-14fc2cs3adc120.85 реле
jqx-14fc2cs3adc121.23.5 реле
jqx-14fc2cs3adc121.25 реле
jqx-14fc2cs3adc1213.5 реле
jqx-14fc2cs3adc1215 реле
jqx-14fc2cs3adc12nil3.5 реле
jqx-14fc2cs3adc12nil5 реле

jqx-14fc2cs3adc240.83.5 реле
jqx-14fc2cs3adc240.85 реле
jqx-14fc2cs3adc241.23.5 реле
jqx-14fc2cs3adc241.25 реле
jqx-14fc2cs3adc2413.5 реле
jqx-14fc2cs3adc2415 реле
jqx-14fc2cs3adc24nil3.5 реле
jqx-14fc2cs3adc24nil5 реле
jqx-14fc2cs3adc60.83.5 реле
jqx-14fc2cs3adc60.85 реле
jqx-14fc2cs3adc61.23.5 реле
jqx-14fc2cs3adc61.25 реле
jqx-14fc2cs3adc613.5 реле
jqx-14fc2cs3adc615 реле
jqx-14fc2cs3adc6nil3.5 реле
jqx-14fc2cs3adc6nil5 реле
jqx-14fc2cs5 реле
jqx-14fc2cs5aac120.83.5 реле
jqx-14fc2cs5aac120.85 реле
jqx-14fc2cs5aac121.23.5 реле
jqx-14fc2cs5aac121.25 реле
jqx-14fc2cs5aac1213.5 реле
jqx-14fc2cs5aac1215 реле
jqx-14fc2cs5aac12nil3.5 реле
jqx-14fc2cs5aac12nil5 реле
jqx-14fc2cs5aac240.83.5 реле
jqx-14fc2cs5aac240.85 реле
jqx-14fc2cs5aac241.23.5 реле

jqx-14fc2cs5aac241.25 реле
jqx-14fc2cs5aac2413.5 реле
jqx-14fc2cs5aac2415 реле
jqx-14fc2cs5aac24nil3.5 реле
jqx-14fc2cs5aac24nil5 реле
jqx-14fc2cs5aac60.83.5 реле
jqx-14fc2cs5aac60.85 реле
jqx-14fc2cs5aac61.23.5 реле
jqx-14fc2cs5aac61.25 реле
jqx-14fc2cs5aac613.5 реле
jqx-14fc2cs5aac615 реле
jqx-14fc2cs5aac6nil3.5 реле
jqx-14fc2cs5aac6nil5 реле
jqx-14fc2cs5adc120.83.5 реле
jqx-14fc2cs5adc120.85 реле
jqx-14fc2cs5adc121.23.5 реле
jqx-14fc2cs5adc121.25 реле
jqx-14fc2cs5adc1213.5 реле
jqx-14fc2cs5adc1215 реле
jqx-14fc2cs5adc12nil3.5 реле
jqx-14fc2cs5adc12nil5 реле
jqx-14fc2cs5adc240.83.5 реле
jqx-14fc2cs5adc240.85 реле
jqx-14fc2cs5adc241.23.5 реле
jqx-14fc2cs5adc241.25 реле
jqx-14fc2cs5adc2413.5 реле
jqx-14fc2cs5adc2415 реле
jqx-14fc2cs5adc24nil3.5 реле

jqx-14fc2cs5adc24nil5 реле
jqx-14fc2cs5adc60.83.5 реле
jqx-14fc2cs5adc60.85 реле
jqx-14fc2cs5adc61.23.5 реле
jqx-14fc2cs5adc61.25 реле
jqx-14fc2cs5adc613.5 реле
jqx-14fc2cs5adc615 реле
jqx-14fc2cs5adc6nil3.5 реле
jqx-14fc2cs5adc6nil5 реле
jqx-14fc2cs6 реле
jqx-14fc2cs6aac120.83.5 реле
jqx-14fc2cs6aac120.85 реле
jqx-14fc2cs6aac121.23.5 реле
jqx-14fc2cs6aac121.25 реле
jqx-14fc2cs6aac1213.5 реле
jqx-14fc2cs6aac1215 реле
jqx-14fc2cs6aac12nil3.5 реле
jqx-14fc2cs6aac12nil5 реле
jqx-14fc2cs6aac240.83.5 реле
jqx-14fc2cs6aac240.85 реле
jqx-14fc2cs6aac241.23.5 реле
jqx-14fc2cs6aac241.25 реле
jqx-14fc2cs6aac2413.5 реле
jqx-14fc2cs6aac2415 реле
jqx-14fc2cs6aac24nil3.5 реле
jqx-14fc2cs6aac24nil5 реле
jqx-14fc2cs6aac60.83.5 реле
jqx-14fc2cs6aac60.85 реле

jqx-14fc2cs6aac61.23.5 реле
jqx-14fc2cs6aac61.25 реле
jqx-14fc2cs6aac613.5 реле
jqx-14fc2cs6aac615 реле
jqx-14fc2cs6aac6nil3.5 реле
jqx-14fc2cs6aac6nil5 реле
jqx-14fc2cs6adc120.83.5 реле
jqx-14fc2cs6adc120.85 реле
jqx-14fc2cs6adc121.23.5 реле
jqx-14fc2cs6adc121.25 реле
jqx-14fc2cs6adc1213.5 реле
jqx-14fc2cs6adc1215 реле
jqx-14fc2cs6adc12nil3.5 реле
jqx-14fc2cs6adc12nil5 реле
jqx-14fc2cs6adc240.83.5 реле
jqx-14fc2cs6adc240.85 реле
jqx-14fc2cs6adc241.23.5 реле
jqx-14fc2cs6adc241.25 реле
jqx-14fc2cs6adc2413.5 реле
jqx-14fc2cs6adc2415 реле
jqx-14fc2cs6adc24nil3.5 реле
jqx-14fc2cs6adc24nil5 реле
jqx-14fc2cs6adc60.83.5 реле
jqx-14fc2cs6adc60.85 реле
jqx-14fc2cs6adc61.23.5 реле
jqx-14fc2cs6adc61.25 реле
jqx-14fc2cs6adc613.5 реле
jqx-14fc2cs6adc615 реле

jqx-14fc2cs6adc6nil3.5 реле
jqx-14fc2cs6adc6nil5 реле
jqx-14fc2cs8 реле
jqx-14fc2cz10 реле
jqx-14fc2cz10aac120.83.5 реле
jqx-14fc2cz10aac120.85 реле
jqx-14fc2cz10aac121.23.5 реле
jqx-14fc2cz10aac121.25 реле
jqx-14fc2cz10aac1213.5 реле
jqx-14fc2cz10aac1215 реле
jqx-14fc2cz10aac12nil3.5 реле
jqx-14fc2cz10aac12nil5 реле
jqx-14fc2cz10aac240.83.5 реле
jqx-14fc2cz10aac240.85 реле
jqx-14fc2cz10aac241.23.5 реле
jqx-14fc2cz10aac241.25 реле
jqx-14fc2cz10aac2413.5 реле
jqx-14fc2cz10aac2415 реле
jqx-14fc2cz10aac24nil3.5 реле
jqx-14fc2cz10aac24nil5 реле
jqx-14fc2cz10aac60.83.5 реле
jqx-14fc2cz10aac60.85 реле
jqx-14fc2cz10aac61.23.5 реле
jqx-14fc2cz10aac61.25 реле
jqx-14fc2cz10aac613.5 реле
jqx-14fc2cz10aac615 реле
jqx-14fc2cz10aac6nil3.5 реле
jqx-14fc2cz10aac6nil5 реле

jqx-14fc2cz10adc120.83.5	реле
jqx-14fc2cz10adc120.85	реле
jqx-14fc2cz10adc121.23.5	реле
jqx-14fc2cz10adc121.25	реле
jqx-14fc2cz10adc1213.5	реле
jqx-14fc2cz10adc1215	реле
jqx-14fc2cz10adc12nil3.5	реле
jqx-14fc2cz10adc12nil5	реле
jqx-14fc2cz10adc240.83.5	реле
jqx-14fc2cz10adc240.85	реле
jqx-14fc2cz10adc241.23.5	реле
jqx-14fc2cz10adc241.25	реле
jqx-14fc2cz10adc2413.5	реле
jqx-14fc2cz10adc2415	реле
jqx-14fc2cz10adc24nil3.5	реле
jqx-14fc2cz10adc24nil5	реле
jqx-14fc2cz10adc60.83.5	реле
jqx-14fc2cz10adc60.85	реле
jqx-14fc2cz10adc61.23.5	реле
jqx-14fc2cz10adc61.25	реле
jqx-14fc2cz10adc613.5	реле
jqx-14fc2cz10adc615	реле
jqx-14fc2cz10adc6nil3.5	реле
jqx-14fc2cz10adc6nil5	реле
jqx-14fc2cz16	реле
jqx-14fc2cz20	реле
jqx-14fc2cz20aac120.83.5	реле
jqx-14fc2cz20aac120.85	реле

jqx-14fc2cz20aac121.23.5	реле
jqx-14fc2cz20aac121.25	реле
jqx-14fc2cz20aac1213.5	реле
jqx-14fc2cz20aac1215	реле
jqx-14fc2cz20aac12nil3.5	реле
jqx-14fc2cz20aac12nil5	реле
jqx-14fc2cz20aac240.83.5	реле
jqx-14fc2cz20aac240.85	реле
jqx-14fc2cz20aac241.23.5	реле
jqx-14fc2cz20aac241.25	реле
jqx-14fc2cz20aac2413.5	реле
jqx-14fc2cz20aac2415	реле
jqx-14fc2cz20aac24nil3.5	реле
jqx-14fc2cz20aac24nil5	реле
jqx-14fc2cz20aac60.83.5	реле
jqx-14fc2cz20aac60.85	реле
jqx-14fc2cz20aac61.23.5	реле
jqx-14fc2cz20aac61.25	реле
jqx-14fc2cz20aac613.5	реле
jqx-14fc2cz20aac615	реле
jqx-14fc2cz20aac6nil3.5	реле
jqx-14fc2cz20aac6nil5	реле
jqx-14fc2cz20adc120.83.5	реле
jqx-14fc2cz20adc120.85	реле
jqx-14fc2cz20adc121.23.5	реле
jqx-14fc2cz20adc121.25	реле
jqx-14fc2cz20adc1213.5	реле
jqx-14fc2cz20adc1215	реле

jqx-14fc2cz20adc12nil3.5	реле
jqx-14fc2cz20adc12nil5	реле
jqx-14fc2cz20adc240.83.5	реле
jqx-14fc2cz20adc240.85	реле
jqx-14fc2cz20adc241.23.5	реле
jqx-14fc2cz20adc241.25	реле
jqx-14fc2cz20adc2413.5	реле
jqx-14fc2cz20adc2415	реле
jqx-14fc2cz20adc24nil3.5	реле
jqx-14fc2cz20adc24nil5	реле
jqx-14fc2cz20adc60.83.5	реле
jqx-14fc2cz20adc60.85	реле
jqx-14fc2cz20adc61.23.5	реле
jqx-14fc2cz20adc61.25	реле
jqx-14fc2cz20adc613.5	реле
jqx-14fc2cz20adc615	реле
jqx-14fc2cz20adc6nil3.5	реле
jqx-14fc2cz20adc6nil5	реле
jqx-14fc2cz3	реле
jqx-14fc2cz3aac120.83.5	реле
jqx-14fc2cz3aac120.85	реле
jqx-14fc2cz3aac121.23.5	реле
jqx-14fc2cz3aac121.25	реле
jqx-14fc2cz3aac1213.5	реле
jqx-14fc2cz3aac1215	реле
jqx-14fc2cz3aac12nil3.5	реле
jqx-14fc2cz3aac12nil5	реле
jqx-14fc2cz3aac240.83.5	реле

jqx-14fc2cz3aac240.85 реле
jqx-14fc2cz3aac241.23.5 реле
jqx-14fc2cz3aac241.25 реле
jqx-14fc2cz3aac2413.5 реле
jqx-14fc2cz3aac2415 реле
jqx-14fc2cz3aac24nil3.5 реле
jqx-14fc2cz3aac24nil5 реле
jqx-14fc2cz3aac60.83.5 реле
jqx-14fc2cz3aac60.85 реле
jqx-14fc2cz3aac61.23.5 реле
jqx-14fc2cz3aac61.25 реле
jqx-14fc2cz3aac613.5 реле
jqx-14fc2cz3aac615 реле
jqx-14fc2cz3aac6nil3.5 реле
jqx-14fc2cz3aac6nil5 реле
jqx-14fc2cz3adc120.83.5 реле
jqx-14fc2cz3adc120.85 реле
jqx-14fc2cz3adc121.23.5 реле
jqx-14fc2cz3adc121.25 реле
jqx-14fc2cz3adc1213.5 реле
jqx-14fc2cz3adc1215 реле
jqx-14fc2cz3adc12nil3.5 реле
jqx-14fc2cz3adc12nil5 реле
jqx-14fc2cz3adc240.83.5 реле
jqx-14fc2cz3adc240.85 реле
jqx-14fc2cz3adc241.23.5 реле
jqx-14fc2cz3adc241.25 реле
jqx-14fc2cz3adc2413.5 реле

jqx-14fc2cz3adc2415 реле
jqx-14fc2cz3adc24nil3.5 реле
jqx-14fc2cz3adc24nil5 реле
jqx-14fc2cz3adc60.83.5 реле
jqx-14fc2cz3adc60.85 реле
jqx-14fc2cz3adc61.23.5 реле
jqx-14fc2cz3adc61.25 реле
jqx-14fc2cz3adc613.5 реле
jqx-14fc2cz3adc615 реле
jqx-14fc2cz3adc6nil3.5 реле
jqx-14fc2cz3adc6nil5 реле
jqx-14fc2cz5 реле
jqx-14fc2cz5aac120.83.5 реле
jqx-14fc2cz5aac120.85 реле
jqx-14fc2cz5aac121.23.5 реле
jqx-14fc2cz5aac121.25 реле
jqx-14fc2cz5aac1213.5 реле
jqx-14fc2cz5aac1215 реле
jqx-14fc2cz5aac12nil3.5 реле
jqx-14fc2cz5aac12nil5 реле
jqx-14fc2cz5aac240.83.5 реле
jqx-14fc2cz5aac240.85 реле
jqx-14fc2cz5aac241.23.5 реле
jqx-14fc2cz5aac241.25 реле
jqx-14fc2cz5aac2413.5 реле
jqx-14fc2cz5aac2415 реле
jqx-14fc2cz5aac24nil3.5 реле
jqx-14fc2cz5aac24nil5 реле

jqx-14fc2cz5aac60.83.5 реле
jqx-14fc2cz5aac60.85 реле
jqx-14fc2cz5aac61.23.5 реле
jqx-14fc2cz5aac61.25 реле
jqx-14fc2cz5aac613.5 реле
jqx-14fc2cz5aac615 реле
jqx-14fc2cz5aac6nil3.5 реле
jqx-14fc2cz5aac6nil5 реле
jqx-14fc2cz5adc120.83.5 реле
jqx-14fc2cz5adc120.85 реле
jqx-14fc2cz5adc121.23.5 реле
jqx-14fc2cz5adc121.25 реле
jqx-14fc2cz5adc1213.5 реле
jqx-14fc2cz5adc1215 реле
jqx-14fc2cz5adc12nil3.5 реле
jqx-14fc2cz5adc12nil5 реле
jqx-14fc2cz5adc240.83.5 реле
jqx-14fc2cz5adc240.85 реле
jqx-14fc2cz5adc241.23.5 реле
jqx-14fc2cz5adc241.25 реле
jqx-14fc2cz5adc2413.5 реле
jqx-14fc2cz5adc2415 реле
jqx-14fc2cz5adc24nil3.5 реле
jqx-14fc2cz5adc24nil5 реле
jqx-14fc2cz5adc60.83.5 реле
jqx-14fc2cz5adc60.85 реле
jqx-14fc2cz5adc61.23.5 реле
jqx-14fc2cz5adc61.25 реле

jqx-14fc2cz5adc613.5 реле
jqx-14fc2cz5adc615 реле
jqx-14fc2cz5adc6nil3.5 реле
jqx-14fc2cz5adc6nil5 реле
jqx-14fc2cz6 реле
jqx-14fc2cz6aac120.83.5 реле
jqx-14fc2cz6aac120.85 реле
jqx-14fc2cz6aac121.23.5 реле
jqx-14fc2cz6aac121.25 реле
jqx-14fc2cz6aac1213.5 реле
jqx-14fc2cz6aac1215 реле
jqx-14fc2cz6aac12nil3.5 реле
jqx-14fc2cz6aac12nil5 реле
jqx-14fc2cz6aac240.83.5 реле
jqx-14fc2cz6aac240.85 реле
jqx-14fc2cz6aac241.23.5 реле
jqx-14fc2cz6aac241.25 реле
jqx-14fc2cz6aac2413.5 реле
jqx-14fc2cz6aac2415 реле
jqx-14fc2cz6aac24nil3.5 реле
jqx-14fc2cz6aac24nil5 реле
jqx-14fc2cz6aac60.83.5 реле
jqx-14fc2cz6aac60.85 реле
jqx-14fc2cz6aac61.23.5 реле
jqx-14fc2cz6aac61.25 реле
jqx-14fc2cz6aac613.5 реле
jqx-14fc2cz6aac615 реле
jqx-14fc2cz6aac6nil3.5 реле

jqx-14fc2cz6aac6nil5 реле
jqx-14fc2cz6adc120.83.5 реле
jqx-14fc2cz6adc120.85 реле
jqx-14fc2cz6adc121.23.5 реле
jqx-14fc2cz6adc121.25 реле
jqx-14fc2cz6adc1213.5 реле
jqx-14fc2cz6adc1215 реле
jqx-14fc2cz6adc12nil3.5 реле
jqx-14fc2cz6adc12nil5 реле
jqx-14fc2cz6adc240.83.5 реле
jqx-14fc2cz6adc240.85 реле
jqx-14fc2cz6adc241.23.5 реле
jqx-14fc2cz6adc241.25 реле
jqx-14fc2cz6adc2413.5 реле
jqx-14fc2cz6adc2415 реле
jqx-14fc2cz6adc24nil3.5 реле
jqx-14fc2cz6adc24nil5 реле
jqx-14fc2cz6adc60.83.5 реле
jqx-14fc2cz6adc60.85 реле
jqx-14fc2cz6adc61.23.5 реле
jqx-14fc2cz6adc61.25 реле
jqx-14fc2cz6adc613.5 реле
jqx-14fc2cz6adc615 реле
jqx-14fc2cz6adc6nil3.5 реле
jqx-14fc2cz6adc6nil5 реле
jqx-14fc2cz8 реле
jqx-14fc3 ningbo forward relay corporation
jqx-14fc32as10 реле

jqx-14fc32as16 реле
jqx-14fc32as20 реле
jqx-14fc32as3 реле
jqx-14fc32as5 реле
jqx-14fc32as6 реле
jqx-14fc32as8 реле
jqx-14fc32az10 реле
jqx-14fc32az16 реле
jqx-14fc32az20 реле
jqx-14fc32az3 реле
jqx-14fc32az5 реле
jqx-14fc32az6 реле
jqx-14fc32az8 реле
jqx-14fc32cs10 реле
jqx-14fc32cs16 реле
jqx-14fc32cs20 реле
jqx-14fc32cs3 реле
jqx-14fc32cs5 реле
jqx-14fc32cs6 реле
jqx-14fc32cs8 реле
jqx-14fc32cz10 реле
jqx-14fc32cz16 реле
jqx-14fc32cz20 реле
jqx-14fc32cz3 реле
jqx-14fc32cz5 реле
jqx-14fc32cz6 реле
jqx-14fc32cz8 реле
jqx-14fc3as10 реле

jqx-14fc3as16	реле
jqx-14fc3as20	реле
jqx-14fc3as3	реле
jqx-14fc3as5	реле
jqx-14fc3as6	реле
jqx-14fc3as8	реле
jqx-14fc3az10	реле
jqx-14fc3az16	реле
jqx-14fc3az20	реле
jqx-14fc3az3	реле
jqx-14fc3az5	реле
jqx-14fc3az6	реле
jqx-14fc3az8	реле
jqx-14fc3cs10	реле
jqx-14fc3cs16	реле
jqx-14fc3cs20	реле
jqx-14fc3cs3	реле
jqx-14fc3cs5	реле
jqx-14fc3cs6	реле
jqx-14fc3cs8	реле
jqx-14fc3cz10	реле
jqx-14fc3cz16	реле
jqx-14fc3cz20	реле
jqx-14fc3cz3	реле
jqx-14fc3cz5	реле
jqx-14fc3cz6	реле
jqx-14fc3cz8	реле
jqx-14fca	huaxinan [huaxinan electronics co.,ltd], heavy load, suitable for heavy power revers

jqx-14fcas10aac120.83.5 реле
jqx-14fcas10aac120.85 реле
jqx-14fcas10aac121.23.5 реле
jqx-14fcas10aac121.25 реле
jqx-14fcas10aac1213.5 реле
jqx-14fcas10aac1215 реле
jqx-14fcas10aac12nil3.5 реле
jqx-14fcas10aac12nil5 реле
jqx-14fcas10aac240.83.5 реле
jqx-14fcas10aac240.85 реле
jqx-14fcas10aac241.23.5 реле
jqx-14fcas10aac241.25 реле
jqx-14fcas10aac2413.5 реле
jqx-14fcas10aac2415 реле
jqx-14fcas10aac24nil3.5 реле
jqx-14fcas10aac24nil5 реле
jqx-14fcas10aac60.83.5 реле
jqx-14fcas10aac60.85 реле
jqx-14fcas10aac61.23.5 реле
jqx-14fcas10aac61.25 реле
jqx-14fcas10aac613.5 реле
jqx-14fcas10aac615 реле
jqx-14fcas10aac6nil3.5 реле
jqx-14fcas10aac6nil5 реле
jqx-14fcas10adc120.83.5 реле
jqx-14fcas10adc120.85 реле
jqx-14fcas10adc121.23.5 реле
jqx-14fcas10adc121.25 реле

jqx-14fcas10adc1213.5 реле
jqx-14fcas10adc1215 реле
jqx-14fcas10adc12nil3.5 реле
jqx-14fcas10adc12nil5 реле
jqx-14fcas10adc240.83.5 реле
jqx-14fcas10adc240.85 реле
jqx-14fcas10adc241.23.5 реле
jqx-14fcas10adc241.25 реле
jqx-14fcas10adc2413.5 реле
jqx-14fcas10adc2415 реле
jqx-14fcas10adc24nil3.5 реле
jqx-14fcas10adc24nil5 реле
jqx-14fcas10adc60.83.5 реле
jqx-14fcas10adc60.85 реле
jqx-14fcas10adc61.23.5 реле
jqx-14fcas10adc61.25 реле
jqx-14fcas10adc613.5 реле
jqx-14fcas10adc615 реле
jqx-14fcas10adc6nil3.5 реле
jqx-14fcas10adc6nil5 реле
jqx-14fcas20aac120.83.5 реле
jqx-14fcas20aac120.85 реле
jqx-14fcas20aac121.23.5 реле
jqx-14fcas20aac121.25 реле
jqx-14fcas20aac1213.5 реле
jqx-14fcas20aac1215 реле
jqx-14fcas20aac12nil3.5 реле
jqx-14fcas20aac12nil5 реле

jqx-14fcas20aac240.83.5 реле
jqx-14fcas20aac240.85 реле
jqx-14fcas20aac241.23.5 реле
jqx-14fcas20aac241.25 реле
jqx-14fcas20aac2413.5 реле
jqx-14fcas20aac2415 реле
jqx-14fcas20aac24nil3.5 реле
jqx-14fcas20aac24nil5 реле
jqx-14fcas20aac60.83.5 реле
jqx-14fcas20aac60.85 реле
jqx-14fcas20aac61.23.5 реле
jqx-14fcas20aac61.25 реле
jqx-14fcas20aac613.5 реле
jqx-14fcas20aac615 реле
jqx-14fcas20aac6nil3.5 реле
jqx-14fcas20aac6nil5 реле
jqx-14fcas20adc120.83.5 реле
jqx-14fcas20adc120.85 реле
jqx-14fcas20adc121.23.5 реле
jqx-14fcas20adc121.25 реле
jqx-14fcas20adc1213.5 реле
jqx-14fcas20adc1215 реле
jqx-14fcas20adc12nil3.5 реле
jqx-14fcas20adc12nil5 реле
jqx-14fcas20adc240.83.5 реле
jqx-14fcas20adc240.85 реле
jqx-14fcas20adc241.23.5 реле
jqx-14fcas20adc241.25 реле

jqx-14fcas20adc2413.5 реле
jqx-14fcas20adc2415 реле
jqx-14fcas20adc24nil3.5 реле
jqx-14fcas20adc24nil5 реле
jqx-14fcas20adc60.83.5 реле
jqx-14fcas20adc60.85 реле
jqx-14fcas20adc61.23.5 реле
jqx-14fcas20adc61.25 реле
jqx-14fcas20adc613.5 реле
jqx-14fcas20adc615 реле
jqx-14fcas20adc6nil3.5 реле
jqx-14fcas20adc6nil5 реле
jqx-14fcas3aac120.83.5 реле
jqx-14fcas3aac120.85 реле
jqx-14fcas3aac121.23.5 реле
jqx-14fcas3aac121.25 реле
jqx-14fcas3aac1213.5 реле
jqx-14fcas3aac1215 реле
jqx-14fcas3aac12nil3.5 реле
jqx-14fcas3aac12nil5 реле
jqx-14fcas3aac240.83.5 реле
jqx-14fcas3aac240.85 реле
jqx-14fcas3aac241.23.5 реле
jqx-14fcas3aac241.25 реле
jqx-14fcas3aac2413.5 реле
jqx-14fcas3aac2415 реле
jqx-14fcas3aac24nil3.5 реле
jqx-14fcas3aac24nil5 реле

jqx-14fcas3aac60.83.5 реле
jqx-14fcas3aac60.85 реле
jqx-14fcas3aac61.23.5 реле
jqx-14fcas3aac61.25 реле
jqx-14fcas3aac613.5 реле
jqx-14fcas3aac615 реле
jqx-14fcas3aac6nil3.5 реле
jqx-14fcas3aac6nil5 реле
jqx-14fcas3adc120.83.5 реле
jqx-14fcas3adc120.85 реле
jqx-14fcas3adc121.23.5 реле
jqx-14fcas3adc121.25 реле
jqx-14fcas3adc1213.5 реле
jqx-14fcas3adc1215 реле
jqx-14fcas3adc12nil3.5 реле
jqx-14fcas3adc12nil5 реле
jqx-14fcas3adc240.83.5 реле
jqx-14fcas3adc240.85 реле
jqx-14fcas3adc241.23.5 реле
jqx-14fcas3adc241.25 реле
jqx-14fcas3adc2413.5 реле
jqx-14fcas3adc2415 реле
jqx-14fcas3adc24nil3.5 реле
jqx-14fcas3adc24nil5 реле
jqx-14fcas3adc60.83.5 реле
jqx-14fcas3adc60.85 реле
jqx-14fcas3adc61.23.5 реле
jqx-14fcas3adc61.25 реле

jqx-14fcas3adc613.5 реле
jqx-14fcas3adc615 реле
jqx-14fcas3adc6nil3.5 реле
jqx-14fcas3adc6nil5 реле
jqx-14fcas5aac120.83.5 реле
jqx-14fcas5aac120.85 реле
jqx-14fcas5aac121.23.5 реле
jqx-14fcas5aac121.25 реле
jqx-14fcas5aac1213.5 реле
jqx-14fcas5aac1215 реле
jqx-14fcas5aac12nil3.5 реле
jqx-14fcas5aac12nil5 реле
jqx-14fcas5aac240.83.5 реле
jqx-14fcas5aac240.85 реле
jqx-14fcas5aac241.23.5 реле
jqx-14fcas5aac241.25 реле
jqx-14fcas5aac2413.5 реле
jqx-14fcas5aac2415 реле
jqx-14fcas5aac24nil3.5 реле
jqx-14fcas5aac24nil5 реле
jqx-14fcas5aac60.83.5 реле
jqx-14fcas5aac60.85 реле
jqx-14fcas5aac61.23.5 реле
jqx-14fcas5aac61.25 реле
jqx-14fcas5aac613.5 реле
jqx-14fcas5aac615 реле
jqx-14fcas5aac6nil3.5 реле
jqx-14fcas5aac6nil5 реле

jqx-14fcas5adc120.83.5 реле
jqx-14fcas5adc120.85 реле
jqx-14fcas5adc121.23.5 реле
jqx-14fcas5adc121.25 реле
jqx-14fcas5adc1213.5 реле
jqx-14fcas5adc1215 реле
jqx-14fcas5adc12nil3.5 реле
jqx-14fcas5adc12nil5 реле
jqx-14fcas5adc240.83.5 реле
jqx-14fcas5adc240.85 реле
jqx-14fcas5adc241.23.5 реле
jqx-14fcas5adc241.25 реле
jqx-14fcas5adc2413.5 реле
jqx-14fcas5adc2415 реле
jqx-14fcas5adc24nil3.5 реле
jqx-14fcas5adc24nil5 реле
jqx-14fcas5adc60.83.5 реле
jqx-14fcas5adc60.85 реле
jqx-14fcas5adc61.23.5 реле
jqx-14fcas5adc61.25 реле
jqx-14fcas5adc613.5 реле
jqx-14fcas5adc615 реле
jqx-14fcas5adc6nil3.5 реле
jqx-14fcas5adc6nil5 реле
jqx-14fcas6aac120.83.5 реле
jqx-14fcas6aac120.85 реле
jqx-14fcas6aac121.23.5 реле
jqx-14fcas6aac121.25 реле

jqx-14fcas6aac1213.5 реле
jqx-14fcas6aac1215 реле
jqx-14fcas6aac12nil3.5 реле
jqx-14fcas6aac12nil5 реле
jqx-14fcas6aac240.83.5 реле
jqx-14fcas6aac240.85 реле
jqx-14fcas6aac241.23.5 реле
jqx-14fcas6aac241.25 реле
jqx-14fcas6aac2413.5 реле
jqx-14fcas6aac2415 реле
jqx-14fcas6aac24nil3.5 реле
jqx-14fcas6aac24nil5 реле
jqx-14fcas6aac60.83.5 реле
jqx-14fcas6aac60.85 реле
jqx-14fcas6aac61.23.5 реле
jqx-14fcas6aac61.25 реле
jqx-14fcas6aac613.5 реле
jqx-14fcas6aac615 реле
jqx-14fcas6aac6nil3.5 реле
jqx-14fcas6aac6nil5 реле
jqx-14fcas6adc120.83.5 реле
jqx-14fcas6adc120.85 реле
jqx-14fcas6adc121.23.5 реле
jqx-14fcas6adc121.25 реле
jqx-14fcas6adc1213.5 реле
jqx-14fcas6adc1215 реле
jqx-14fcas6adc12nil3.5 реле
jqx-14fcas6adc12nil5 реле

jqx-14fcas6adc240.83.5 реле
jqx-14fcas6adc240.85 реле
jqx-14fcas6adc241.23.5 реле
jqx-14fcas6adc241.25 реле
jqx-14fcas6adc2413.5 реле
jqx-14fcas6adc2415 реле
jqx-14fcas6adc24nil3.5 реле
jqx-14fcas6adc24nil5 реле
jqx-14fcas6adc60.83.5 реле
jqx-14fcas6adc60.85 реле
jqx-14fcas6adc61.23.5 реле
jqx-14fcas6adc61.25 реле
jqx-14fcas6adc613.5 реле
jqx-14fcas6adc615 реле
jqx-14fcas6adc6nil3.5 реле
jqx-14fcas6adc6nil5 реле
jqx-14fcaz10aac120.83.5 реле
jqx-14fcaz10aac120.85 реле
jqx-14fcaz10aac121.23.5 реле
jqx-14fcaz10aac121.25 реле
jqx-14fcaz10aac1213.5 реле
jqx-14fcaz10aac1215 реле
jqx-14fcaz10aac12nil3.5 реле
jqx-14fcaz10aac12nil5 реле
jqx-14fcaz10aac240.83.5 реле
jqx-14fcaz10aac240.85 реле
jqx-14fcaz10aac241.23.5 реле
jqx-14fcaz10aac241.25 реле

jqx-14fcaz10aac2413.5 реле
jqx-14fcaz10aac2415 реле
jqx-14fcaz10aac24nil3.5 реле
jqx-14fcaz10aac24nil5 реле
jqx-14fcaz10aac60.83.5 реле
jqx-14fcaz10aac60.85 реле
jqx-14fcaz10aac61.23.5 реле
jqx-14fcaz10aac61.25 реле
jqx-14fcaz10aac613.5 реле
jqx-14fcaz10aac615 реле
jqx-14fcaz10aac6nil3.5 реле
jqx-14fcaz10aac6nil5 реле
jqx-14fcaz10adc120.83.5 реле
jqx-14fcaz10adc120.85 реле
jqx-14fcaz10adc121.23.5 реле
jqx-14fcaz10adc121.25 реле
jqx-14fcaz10adc1213.5 реле
jqx-14fcaz10adc1215 реле
jqx-14fcaz10adc12nil3.5 реле
jqx-14fcaz10adc12nil5 реле
jqx-14fcaz10adc240.83.5 реле
jqx-14fcaz10adc240.85 реле
jqx-14fcaz10adc241.23.5 реле
jqx-14fcaz10adc241.25 реле
jqx-14fcaz10adc2413.5 реле
jqx-14fcaz10adc2415 реле
jqx-14fcaz10adc24nil3.5 реле
jqx-14fcaz10adc24nil5 реле

jqx-14fcaz10adc60.83.5 реле
jqx-14fcaz10adc60.85 реле
jqx-14fcaz10adc61.23.5 реле
jqx-14fcaz10adc61.25 реле
jqx-14fcaz10adc613.5 реле
jqx-14fcaz10adc615 реле
jqx-14fcaz10adc6nil3.5 реле
jqx-14fcaz10adc6nil5 реле
jqx-14fcaz20aac120.83.5 реле
jqx-14fcaz20aac120.85 реле
jqx-14fcaz20aac121.23.5 реле
jqx-14fcaz20aac121.25 реле
jqx-14fcaz20aac1213.5 реле
jqx-14fcaz20aac1215 реле
jqx-14fcaz20aac12nil3.5 реле
jqx-14fcaz20aac12nil5 реле
jqx-14fcaz20aac240.83.5 реле
jqx-14fcaz20aac240.85 реле
jqx-14fcaz20aac241.23.5 реле
jqx-14fcaz20aac241.25 реле
jqx-14fcaz20aac2413.5 реле
jqx-14fcaz20aac2415 реле
jqx-14fcaz20aac24nil3.5 реле
jqx-14fcaz20aac24nil5 реле
jqx-14fcaz20aac60.83.5 реле
jqx-14fcaz20aac60.85 реле
jqx-14fcaz20aac61.23.5 реле
jqx-14fcaz20aac61.25 реле

jqx-14fcaz20aac613.5 реле
jqx-14fcaz20aac615 реле
jqx-14fcaz20aac6nil3.5 реле
jqx-14fcaz20aac6nil5 реле
jqx-14fcaz20adc120.83.5 реле
jqx-14fcaz20adc120.85 реле
jqx-14fcaz20adc121.23.5 реле
jqx-14fcaz20adc121.25 реле
jqx-14fcaz20adc1213.5 реле
jqx-14fcaz20adc1215 реле
jqx-14fcaz20adc12nil3.5 реле
jqx-14fcaz20adc12nil5 реле
jqx-14fcaz20adc240.83.5 реле
jqx-14fcaz20adc240.85 реле
jqx-14fcaz20adc241.23.5 реле
jqx-14fcaz20adc241.25 реле
jqx-14fcaz20adc2413.5 реле
jqx-14fcaz20adc2415 реле
jqx-14fcaz20adc24nil3.5 реле
jqx-14fcaz20adc24nil5 реле
jqx-14fcaz20adc60.83.5 реле
jqx-14fcaz20adc60.85 реле
jqx-14fcaz20adc61.23.5 реле
jqx-14fcaz20adc61.25 реле
jqx-14fcaz20adc613.5 реле
jqx-14fcaz20adc615 реле
jqx-14fcaz20adc6nil3.5 реле
jqx-14fcaz20adc6nil5 реле

jqx-14fcaz3aac120.83.5 реле
jqx-14fcaz3aac120.85 реле
jqx-14fcaz3aac121.23.5 реле
jqx-14fcaz3aac121.25 реле
jqx-14fcaz3aac1213.5 реле
jqx-14fcaz3aac1215 реле
jqx-14fcaz3aac12nil3.5 реле
jqx-14fcaz3aac12nil5 реле
jqx-14fcaz3aac240.83.5 реле
jqx-14fcaz3aac240.85 реле
jqx-14fcaz3aac241.23.5 реле
jqx-14fcaz3aac241.25 реле
jqx-14fcaz3aac2413.5 реле
jqx-14fcaz3aac2415 реле
jqx-14fcaz3aac24nil3.5 реле
jqx-14fcaz3aac24nil5 реле
jqx-14fcaz3aac60.83.5 реле
jqx-14fcaz3aac60.85 реле
jqx-14fcaz3aac61.23.5 реле
jqx-14fcaz3aac61.25 реле
jqx-14fcaz3aac613.5 реле
jqx-14fcaz3aac615 реле
jqx-14fcaz3aac6nil3.5 реле
jqx-14fcaz3aac6nil5 реле
jqx-14fcaz3adc120.83.5 реле
jqx-14fcaz3adc120.85 реле
jqx-14fcaz3adc121.23.5 реле
jqx-14fcaz3adc121.25 реле

jqx-14fcaz3adc1213.5 реле
jqx-14fcaz3adc1215 реле
jqx-14fcaz3adc12nil3.5 реле
jqx-14fcaz3adc12nil5 реле
jqx-14fcaz3adc240.83.5 реле
jqx-14fcaz3adc240.85 реле
jqx-14fcaz3adc241.23.5 реле
jqx-14fcaz3adc241.25 реле
jqx-14fcaz3adc2413.5 реле
jqx-14fcaz3adc2415 реле
jqx-14fcaz3adc24nil3.5 реле
jqx-14fcaz3adc24nil5 реле
jqx-14fcaz3adc60.83.5 реле
jqx-14fcaz3adc60.85 реле
jqx-14fcaz3adc61.23.5 реле
jqx-14fcaz3adc61.25 реле
jqx-14fcaz3adc613.5 реле
jqx-14fcaz3adc615 реле
jqx-14fcaz3adc6nil3.5 реле
jqx-14fcaz3adc6nil5 реле
jqx-14fcaz5aac120.83.5 реле
jqx-14fcaz5aac120.85 реле
jqx-14fcaz5aac121.23.5 реле
jqx-14fcaz5aac121.25 реле
jqx-14fcaz5aac1213.5 реле
jqx-14fcaz5aac1215 реле
jqx-14fcaz5aac12nil3.5 реле
jqx-14fcaz5aac12nil5 реле

jqx-14fcaz5aac240.83.5 реле
jqx-14fcaz5aac240.85 реле
jqx-14fcaz5aac241.23.5 реле
jqx-14fcaz5aac241.25 реле
jqx-14fcaz5aac2413.5 реле
jqx-14fcaz5aac2415 реле
jqx-14fcaz5aac24nil3.5 реле
jqx-14fcaz5aac24nil5 реле
jqx-14fcaz5aac60.83.5 реле
jqx-14fcaz5aac60.85 реле
jqx-14fcaz5aac61.23.5 реле
jqx-14fcaz5aac61.25 реле
jqx-14fcaz5aac613.5 реле
jqx-14fcaz5aac615 реле
jqx-14fcaz5aac6nil3.5 реле
jqx-14fcaz5aac6nil5 реле
jqx-14fcaz5adc120.83.5 реле
jqx-14fcaz5adc120.85 реле
jqx-14fcaz5adc121.23.5 реле
jqx-14fcaz5adc121.25 реле
jqx-14fcaz5adc1213.5 реле
jqx-14fcaz5adc1215 реле
jqx-14fcaz5adc12nil3.5 реле
jqx-14fcaz5adc12nil5 реле
jqx-14fcaz5adc240.83.5 реле
jqx-14fcaz5adc240.85 реле
jqx-14fcaz5adc241.23.5 реле
jqx-14fcaz5adc241.25 реле

jqx-14fcaz5adc2413.5 реле
jqx-14fcaz5adc2415 реле
jqx-14fcaz5adc24nil3.5 реле
jqx-14fcaz5adc24nil5 реле
jqx-14fcaz5adc60.83.5 реле
jqx-14fcaz5adc60.85 реле
jqx-14fcaz5adc61.23.5 реле
jqx-14fcaz5adc61.25 реле
jqx-14fcaz5adc613.5 реле
jqx-14fcaz5adc615 реле
jqx-14fcaz5adc6nil3.5 реле
jqx-14fcaz5adc6nil5 реле
jqx-14fcaz6aac120.83.5 реле
jqx-14fcaz6aac120.85 реле
jqx-14fcaz6aac121.23.5 реле
jqx-14fcaz6aac121.25 реле
jqx-14fcaz6aac1213.5 реле
jqx-14fcaz6aac1215 реле
jqx-14fcaz6aac12nil3.5 реле
jqx-14fcaz6aac12nil5 реле
jqx-14fcaz6aac240.83.5 реле
jqx-14fcaz6aac240.85 реле
jqx-14fcaz6aac241.23.5 реле
jqx-14fcaz6aac241.25 реле
jqx-14fcaz6aac2413.5 реле
jqx-14fcaz6aac2415 реле
jqx-14fcaz6aac24nil3.5 реле
jqx-14fcaz6aac24nil5 реле

jqx-14fcaz6aac60.83.5 реле
jqx-14fcaz6aac60.85 реле
jqx-14fcaz6aac61.23.5 реле
jqx-14fcaz6aac61.25 реле
jqx-14fcaz6aac613.5 реле
jqx-14fcaz6aac615 реле
jqx-14fcaz6aac6nil3.5 реле
jqx-14fcaz6aac6nil5 реле
jqx-14fcaz6adc120.83.5 реле
jqx-14fcaz6adc120.85 реле
jqx-14fcaz6adc121.23.5 реле
jqx-14fcaz6adc121.25 реле
jqx-14fcaz6adc1213.5 реле
jqx-14fcaz6adc1215 реле
jqx-14fcaz6adc12nil3.5 реле
jqx-14fcaz6adc12nil5 реле
jqx-14fcaz6adc240.83.5 реле
jqx-14fcaz6adc240.85 реле
jqx-14fcaz6adc241.23.5 реле
jqx-14fcaz6adc241.25 реле
jqx-14fcaz6adc2413.5 реле
jqx-14fcaz6adc2415 реле
jqx-14fcaz6adc24nil3.5 реле
jqx-14fcaz6adc24nil5 реле
jqx-14fcaz6adc60.83.5 реле
jqx-14fcaz6adc60.85 реле
jqx-14fcaz6adc61.23.5 реле
jqx-14fcaz6adc61.25 реле

jqx-14fcaz6adc613.5 реле
jqx-14fcaz6adc615 реле
jqx-14fcaz6adc6nil3.5 реле
jqx-14fcaz6adc6nil5 реле
jqx-14fcc huaxinan [huaxinan electronics co.,ltd], heavy load, suitable for heavy power revers
jqx-14fcss10aac120.83.5 реле
jqx-14fcss10aac120.85 реле
jqx-14fcss10aac121.23.5 реле
jqx-14fcss10aac121.25 реле
jqx-14fcss10aac1213.5 реле
jqx-14fcss10aac1215 реле
jqx-14fcss10aac12nil3.5 реле
jqx-14fcss10aac12nil5 реле
jqx-14fcss10aac240.83.5 реле
jqx-14fcss10aac240.85 реле
jqx-14fcss10aac241.23.5 реле
jqx-14fcss10aac241.25 реле
jqx-14fcss10aac2413.5 реле
jqx-14fcss10aac2415 реле
jqx-14fcss10aac24nil3.5 реле
jqx-14fcss10aac24nil5 реле
jqx-14fcss10aac60.83.5 реле
jqx-14fcss10aac60.85 реле
jqx-14fcss10aac61.23.5 реле
jqx-14fcss10aac61.25 реле
jqx-14fcss10aac613.5 реле
jqx-14fcss10aac615 реле
jqx-14fcss10aac6nil3.5 реле

jqx-14fcss10aac6nil5 реле
jqx-14fcss10adc120.83.5 реле
jqx-14fcss10adc120.85 реле
jqx-14fcss10adc121.23.5 реле
jqx-14fcss10adc121.25 реле
jqx-14fcss10adc1213.5 реле
jqx-14fcss10adc1215 реле
jqx-14fcss10adc12nil3.5 реле
jqx-14fcss10adc12nil5 реле
jqx-14fcss10adc240.83.5 реле
jqx-14fcss10adc240.85 реле
jqx-14fcss10adc241.23.5 реле
jqx-14fcss10adc241.25 реле
jqx-14fcss10adc2413.5 реле
jqx-14fcss10adc2415 реле
jqx-14fcss10adc24nil3.5 реле
jqx-14fcss10adc24nil5 реле
jqx-14fcss10adc60.83.5 реле
jqx-14fcss10adc60.85 реле
jqx-14fcss10adc61.23.5 реле
jqx-14fcss10adc61.25 реле
jqx-14fcss10adc613.5 реле
jqx-14fcss10adc615 реле
jqx-14fcss10adc6nil3.5 реле
jqx-14fcss10adc6nil5 реле
jqx-14fcss10dc12v0.83.5 ningbo forward relay corporation
jqx-14fcss20aac120.83.5 реле
jqx-14fcss20aac120.85 реле

jqx-14fcss20aac121.23.5 реле
jqx-14fcss20aac121.25 реле
jqx-14fcss20aac1213.5 реле
jqx-14fcss20aac1215 реле
jqx-14fcss20aac12nil3.5 реле
jqx-14fcss20aac12nil5 реле
jqx-14fcss20aac240.83.5 реле
jqx-14fcss20aac240.85 реле
jqx-14fcss20aac241.23.5 реле
jqx-14fcss20aac241.25 реле
jqx-14fcss20aac2413.5 реле
jqx-14fcss20aac2415 реле
jqx-14fcss20aac24nil3.5 реле
jqx-14fcss20aac24nil5 реле
jqx-14fcss20aac60.83.5 реле
jqx-14fcss20aac60.85 реле
jqx-14fcss20aac61.23.5 реле
jqx-14fcss20aac61.25 реле
jqx-14fcss20aac613.5 реле
jqx-14fcss20aac615 реле
jqx-14fcss20aac6nil3.5 реле
jqx-14fcss20aac6nil5 реле
jqx-14fcss20adc120.83.5 реле
jqx-14fcss20adc120.85 реле
jqx-14fcss20adc121.23.5 реле
jqx-14fcss20adc121.25 реле
jqx-14fcss20adc1213.5 реле
jqx-14fcss20adc1215 реле

jqx-14fcss20adc12nil3.5 реле
jqx-14fcss20adc12nil5 реле
jqx-14fcss20adc240.83.5 реле
jqx-14fcss20adc240.85 реле
jqx-14fcss20adc241.23.5 реле
jqx-14fcss20adc241.25 реле
jqx-14fcss20adc2413.5 реле
jqx-14fcss20adc2415 реле
jqx-14fcss20adc24nil3.5 реле
jqx-14fcss20adc24nil5 реле
jqx-14fcss20adc60.83.5 реле
jqx-14fcss20adc60.85 реле
jqx-14fcss20adc61.23.5 реле
jqx-14fcss20adc61.25 реле
jqx-14fcss20adc613.5 реле
jqx-14fcss20adc615 реле
jqx-14fcss20adc6nil3.5 реле
jqx-14fcss20adc6nil5 реле
jqx-14fcss3aac120.83.5 реле
jqx-14fcss3aac120.85 реле
jqx-14fcss3aac121.23.5 реле
jqx-14fcss3aac121.25 реле
jqx-14fcss3aac1213.5 реле
jqx-14fcss3aac1215 реле
jqx-14fcss3aac12nil3.5 реле
jqx-14fcss3aac12nil5 реле
jqx-14fcss3aac240.83.5 реле
jqx-14fcss3aac240.85 реле

jqx-14fcss3aac241.23.5 реле
jqx-14fcss3aac241.25 реле
jqx-14fcss3aac2413.5 реле
jqx-14fcss3aac2415 реле
jqx-14fcss3aac24nil3.5 реле
jqx-14fcss3aac24nil5 реле
jqx-14fcss3aac60.83.5 реле
jqx-14fcss3aac60.85 реле
jqx-14fcss3aac61.23.5 реле
jqx-14fcss3aac61.25 реле
jqx-14fcss3aac613.5 реле
jqx-14fcss3aac615 реле
jqx-14fcss3aac6nil3.5 реле
jqx-14fcss3aac6nil5 реле
jqx-14fcss3adc120.83.5 реле
jqx-14fcss3adc120.85 реле
jqx-14fcss3adc121.23.5 реле
jqx-14fcss3adc121.25 реле
jqx-14fcss3adc1213.5 реле
jqx-14fcss3adc1215 реле
jqx-14fcss3adc12nil3.5 реле
jqx-14fcss3adc12nil5 реле
jqx-14fcss3adc240.83.5 реле
jqx-14fcss3adc240.85 реле
jqx-14fcss3adc241.23.5 реле
jqx-14fcss3adc241.25 реле
jqx-14fcss3adc2413.5 реле
jqx-14fcss3adc2415 реле

jqx-14fccc3adc24nil3.5 реле
jqx-14fccc3adc24nil5 реле
jqx-14fccc3adc60.83.5 реле
jqx-14fccc3adc60.85 реле
jqx-14fccc3adc61.23.5 реле
jqx-14fccc3adc61.25 реле
jqx-14fccc3adc613.5 реле
jqx-14fccc3adc615 реле
jqx-14fccc3adc6nil3.5 реле
jqx-14fccc3adc6nil5 реле
jqx-14fccc5aac120.83.5 реле
jqx-14fccc5aac120.85 реле
jqx-14fccc5aac121.23.5 реле
jqx-14fccc5aac121.25 реле
jqx-14fccc5aac1213.5 реле
jqx-14fccc5aac1215 реле
jqx-14fccc5aac12nil3.5 реле
jqx-14fccc5aac12nil5 реле
jqx-14fccc5aac240.83.5 реле
jqx-14fccc5aac240.85 реле
jqx-14fccc5aac241.23.5 реле
jqx-14fccc5aac241.25 реле
jqx-14fccc5aac2413.5 реле
jqx-14fccc5aac2415 реле
jqx-14fccc5aac24nil3.5 реле
jqx-14fccc5aac24nil5 реле
jqx-14fccc5aac60.83.5 реле
jqx-14fccc5aac60.85 реле

jqx-14fcss5aac61.23.5 реле
jqx-14fcss5aac61.25 реле
jqx-14fcss5aac613.5 реле
jqx-14fcss5aac615 реле
jqx-14fcss5aac6nil3.5 реле
jqx-14fcss5aac6nil5 реле
jqx-14fcss5adc120.83.5 реле
jqx-14fcss5adc120.85 реле
jqx-14fcss5adc121.23.5 реле
jqx-14fcss5adc121.25 реле
jqx-14fcss5adc1213.5 реле
jqx-14fcss5adc1215 реле
jqx-14fcss5adc12nil3.5 реле
jqx-14fcss5adc12nil5 реле
jqx-14fcss5adc240.83.5 реле
jqx-14fcss5adc240.85 реле
jqx-14fcss5adc241.23.5 реле
jqx-14fcss5adc241.25 реле
jqx-14fcss5adc2413.5 реле
jqx-14fcss5adc2415 реле
jqx-14fcss5adc24nil3.5 реле
jqx-14fcss5adc24nil5 реле
jqx-14fcss5adc60.83.5 реле
jqx-14fcss5adc60.85 реле
jqx-14fcss5adc61.23.5 реле
jqx-14fcss5adc61.25 реле
jqx-14fcss5adc613.5 реле
jqx-14fcss5adc615 реле

jqx-14fcss5adc6nil3.5 реле
jqx-14fcss5adc6nil5 реле
jqx-14fcss6aac120.83.5 реле
jqx-14fcss6aac120.85 реле
jqx-14fcss6aac121.23.5 реле
jqx-14fcss6aac121.25 реле
jqx-14fcss6aac1213.5 реле
jqx-14fcss6aac1215 реле
jqx-14fcss6aac12nil3.5 реле
jqx-14fcss6aac12nil5 реле
jqx-14fcss6aac240.83.5 реле
jqx-14fcss6aac240.85 реле
jqx-14fcss6aac241.23.5 реле
jqx-14fcss6aac241.25 реле
jqx-14fcss6aac2413.5 реле
jqx-14fcss6aac2415 реле
jqx-14fcss6aac24nil3.5 реле
jqx-14fcss6aac24nil5 реле
jqx-14fcss6aac60.83.5 реле
jqx-14fcss6aac60.85 реле
jqx-14fcss6aac61.23.5 реле
jqx-14fcss6aac61.25 реле
jqx-14fcss6aac613.5 реле
jqx-14fcss6aac615 реле
jqx-14fcss6aac6nil3.5 реле
jqx-14fcss6aac6nil5 реле
jqx-14fcss6adc120.83.5 реле
jqx-14fcss6adc120.85 реле

jqx-14fcss6adc121.23.5 реле
jqx-14fcss6adc121.25 реле
jqx-14fcss6adc1213.5 реле
jqx-14fcss6adc1215 реле
jqx-14fcss6adc12nil3.5 реле
jqx-14fcss6adc12nil5 реле
jqx-14fcss6adc240.83.5 реле
jqx-14fcss6adc240.85 реле
jqx-14fcss6adc241.23.5 реле
jqx-14fcss6adc241.25 реле
jqx-14fcss6adc2413.5 реле
jqx-14fcss6adc2415 реле
jqx-14fcss6adc24nil3.5 реле
jqx-14fcss6adc24nil5 реле
jqx-14fcss6adc60.83.5 реле
jqx-14fcss6adc60.85 реле
jqx-14fcss6adc61.23.5 реле
jqx-14fcss6adc61.25 реле
jqx-14fcss6adc613.5 реле
jqx-14fcss6adc615 реле
jqx-14fcss6adc6nil3.5 реле
jqx-14fcss6adc6nil5 реле
jqx-14fccz10aac120.83.5 реле
jqx-14fccz10aac120.85 реле
jqx-14fccz10aac121.23.5 реле
jqx-14fccz10aac121.25 реле
jqx-14fccz10aac1213.5 реле
jqx-14fccz10aac1215 реле

jqx-14fccz10aac12nil3.5 реле
jqx-14fccz10aac12nil5 реле
jqx-14fccz10aac240.83.5 реле
jqx-14fccz10aac240.85 реле
jqx-14fccz10aac241.23.5 реле
jqx-14fccz10aac241.25 реле
jqx-14fccz10aac2413.5 реле
jqx-14fccz10aac2415 реле
jqx-14fccz10aac24nil3.5 реле
jqx-14fccz10aac24nil5 реле
jqx-14fccz10aac60.83.5 реле
jqx-14fccz10aac60.85 реле
jqx-14fccz10aac61.23.5 реле
jqx-14fccz10aac61.25 реле
jqx-14fccz10aac613.5 реле
jqx-14fccz10aac615 реле
jqx-14fccz10aac6nil3.5 реле
jqx-14fccz10aac6nil5 реле
jqx-14fccz10adc120.83.5 реле
jqx-14fccz10adc120.85 реле
jqx-14fccz10adc121.23.5 реле
jqx-14fccz10adc121.25 реле
jqx-14fccz10adc1213.5 реле
jqx-14fccz10adc1215 реле
jqx-14fccz10adc12nil3.5 реле
jqx-14fccz10adc12nil5 реле
jqx-14fccz10adc240.83.5 реле
jqx-14fccz10adc240.85 реле

jqx-14fccz10adc241.23.5 реле
jqx-14fccz10adc241.25 реле
jqx-14fccz10adc2413.5 реле
jqx-14fccz10adc2415 реле
jqx-14fccz10adc24nil3.5 реле
jqx-14fccz10adc24nil5 реле
jqx-14fccz10adc60.83.5 реле
jqx-14fccz10adc60.85 реле
jqx-14fccz10adc61.23.5 реле
jqx-14fccz10adc61.25 реле
jqx-14fccz10adc613.5 реле
jqx-14fccz10adc615 реле
jqx-14fccz10adc6nil3.5 реле
jqx-14fccz10adc6nil5 реле
jqx-14fccz20aac120.83.5 реле
jqx-14fccz20aac120.85 реле
jqx-14fccz20aac121.23.5 реле
jqx-14fccz20aac121.25 реле
jqx-14fccz20aac1213.5 реле
jqx-14fccz20aac1215 реле
jqx-14fccz20aac12nil3.5 реле
jqx-14fccz20aac12nil5 реле
jqx-14fccz20aac240.83.5 реле
jqx-14fccz20aac240.85 реле
jqx-14fccz20aac241.23.5 реле
jqx-14fccz20aac241.25 реле
jqx-14fccz20aac2413.5 реле
jqx-14fccz20aac2415 реле

jqx-14fccz20aac24nil3.5 реле
jqx-14fccz20aac24nil5 реле
jqx-14fccz20aac60.83.5 реле
jqx-14fccz20aac60.85 реле
jqx-14fccz20aac61.23.5 реле
jqx-14fccz20aac61.25 реле
jqx-14fccz20aac613.5 реле
jqx-14fccz20aac615 реле
jqx-14fccz20aac6nil3.5 реле
jqx-14fccz20aac6nil5 реле
jqx-14fccz20adc120.83.5 реле
jqx-14fccz20adc120.85 реле
jqx-14fccz20adc121.23.5 реле
jqx-14fccz20adc121.25 реле
jqx-14fccz20adc1213.5 реле
jqx-14fccz20adc1215 реле
jqx-14fccz20adc12nil3.5 реле
jqx-14fccz20adc12nil5 реле
jqx-14fccz20adc240.83.5 реле
jqx-14fccz20adc240.85 реле
jqx-14fccz20adc241.23.5 реле
jqx-14fccz20adc241.25 реле
jqx-14fccz20adc2413.5 реле
jqx-14fccz20adc2415 реле
jqx-14fccz20adc24nil3.5 реле
jqx-14fccz20adc24nil5 реле
jqx-14fccz20adc60.83.5 реле
jqx-14fccz20adc60.85 реле

jqx-14fccz20adc61.23.5 реле
jqx-14fccz20adc61.25 реле
jqx-14fccz20adc613.5 реле
jqx-14fccz20adc615 реле
jqx-14fccz20adc6nil3.5 реле
jqx-14fccz20adc6nil5 реле
jqx-14fccz3aac120.83.5 реле
jqx-14fccz3aac120.85 реле
jqx-14fccz3aac121.23.5 реле
jqx-14fccz3aac121.25 реле
jqx-14fccz3aac1213.5 реле
jqx-14fccz3aac1215 реле
jqx-14fccz3aac12nil3.5 реле
jqx-14fccz3aac12nil5 реле
jqx-14fccz3aac240.83.5 реле
jqx-14fccz3aac240.85 реле
jqx-14fccz3aac241.23.5 реле
jqx-14fccz3aac241.25 реле
jqx-14fccz3aac2413.5 реле
jqx-14fccz3aac2415 реле
jqx-14fccz3aac24nil3.5 реле
jqx-14fccz3aac24nil5 реле
jqx-14fccz3aac60.83.5 реле
jqx-14fccz3aac60.85 реле
jqx-14fccz3aac61.23.5 реле
jqx-14fccz3aac61.25 реле
jqx-14fccz3aac613.5 реле
jqx-14fccz3aac615 реле

jqx-14fccz3aac6nil3.5 реле
jqx-14fccz3aac6nil5 реле
jqx-14fccz3adc120.83.5 реле
jqx-14fccz3adc120.85 реле
jqx-14fccz3adc121.23.5 реле
jqx-14fccz3adc121.25 реле
jqx-14fccz3adc1213.5 реле
jqx-14fccz3adc1215 реле
jqx-14fccz3adc12nil3.5 реле
jqx-14fccz3adc12nil5 реле
jqx-14fccz3adc240.83.5 реле
jqx-14fccz3adc240.85 реле
jqx-14fccz3adc241.23.5 реле
jqx-14fccz3adc241.25 реле
jqx-14fccz3adc2413.5 реле
jqx-14fccz3adc2415 реле
jqx-14fccz3adc24nil3.5 реле
jqx-14fccz3adc24nil5 реле
jqx-14fccz3adc60.83.5 реле
jqx-14fccz3adc60.85 реле
jqx-14fccz3adc61.23.5 реле
jqx-14fccz3adc61.25 реле
jqx-14fccz3adc613.5 реле
jqx-14fccz3adc615 реле
jqx-14fccz3adc6nil3.5 реле
jqx-14fccz3adc6nil5 реле
jqx-14fccz5aac120.83.5 реле
jqx-14fccz5aac120.85 реле

jqx-14fccz5aac121.23.5 реле
jqx-14fccz5aac121.25 реле
jqx-14fccz5aac1213.5 реле
jqx-14fccz5aac1215 реле
jqx-14fccz5aac12nil3.5 реле
jqx-14fccz5aac12nil5 реле
jqx-14fccz5aac240.83.5 реле
jqx-14fccz5aac240.85 реле
jqx-14fccz5aac241.23.5 реле
jqx-14fccz5aac241.25 реле
jqx-14fccz5aac2413.5 реле
jqx-14fccz5aac2415 реле
jqx-14fccz5aac24nil3.5 реле
jqx-14fccz5aac24nil5 реле
jqx-14fccz5aac60.83.5 реле
jqx-14fccz5aac60.85 реле
jqx-14fccz5aac61.23.5 реле
jqx-14fccz5aac61.25 реле
jqx-14fccz5aac613.5 реле
jqx-14fccz5aac615 реле
jqx-14fccz5aac6nil3.5 реле
jqx-14fccz5aac6nil5 реле
jqx-14fccz5adc120.83.5 реле
jqx-14fccz5adc120.85 реле
jqx-14fccz5adc121.23.5 реле
jqx-14fccz5adc121.25 реле
jqx-14fccz5adc1213.5 реле
jqx-14fccz5adc1215 реле

jqx-14fccz5adc12nil3.5 реле
jqx-14fccz5adc12nil5 реле
jqx-14fccz5adc240.83.5 реле
jqx-14fccz5adc240.85 реле
jqx-14fccz5adc241.23.5 реле
jqx-14fccz5adc241.25 реле
jqx-14fccz5adc2413.5 реле
jqx-14fccz5adc2415 реле
jqx-14fccz5adc24nil3.5 реле
jqx-14fccz5adc24nil5 реле
jqx-14fccz5adc60.83.5 реле
jqx-14fccz5adc60.85 реле
jqx-14fccz5adc61.23.5 реле
jqx-14fccz5adc61.25 реле
jqx-14fccz5adc613.5 реле
jqx-14fccz5adc615 реле
jqx-14fccz5adc6nil3.5 реле
jqx-14fccz5adc6nil5 реле
jqx-14fccz6aac120.83.5 реле
jqx-14fccz6aac120.85 реле
jqx-14fccz6aac121.23.5 реле
jqx-14fccz6aac121.25 реле
jqx-14fccz6aac1213.5 реле
jqx-14fccz6aac1215 реле
jqx-14fccz6aac12nil3.5 реле
jqx-14fccz6aac12nil5 реле
jqx-14fccz6aac240.83.5 реле
jqx-14fccz6aac240.85 реле

jqx-14fccz6aac241.23.5 реле
jqx-14fccz6aac241.25 реле
jqx-14fccz6aac2413.5 реле
jqx-14fccz6aac2415 реле
jqx-14fccz6aac24nil3.5 реле
jqx-14fccz6aac24nil5 реле
jqx-14fccz6aac60.83.5 реле
jqx-14fccz6aac60.85 реле
jqx-14fccz6aac61.23.5 реле
jqx-14fccz6aac61.25 реле
jqx-14fccz6aac613.5 реле
jqx-14fccz6aac615 реле
jqx-14fccz6aac6nil3.5 реле
jqx-14fccz6aac6nil5 реле
jqx-14fccz6adc120.83.5 реле
jqx-14fccz6adc120.85 реле
jqx-14fccz6adc121.23.5 реле
jqx-14fccz6adc121.25 реле
jqx-14fccz6adc1213.5 реле
jqx-14fccz6adc1215 реле
jqx-14fccz6adc12nil3.5 реле
jqx-14fccz6adc12nil5 реле
jqx-14fccz6adc240.83.5 реле
jqx-14fccz6adc240.85 реле
jqx-14fccz6adc241.23.5 реле
jqx-14fccz6adc241.25 реле
jqx-14fccz6adc2413.5 реле
jqx-14fccz6adc2415 реле

jqx-14fccz6adc24nil3.5 реле
jqx-14fccz6adc24nil5 реле
jqx-14fccz6adc60.83.5 реле
jqx-14fccz6adc60.85 реле
jqx-14fccz6adc61.23.5 реле
jqx-14fccz6adc61.25 реле
jqx-14fccz6adc613.5 реле
jqx-14fccz6adc615 реле
jqx-14fccz6adc6nil3.5 реле
jqx-14fccz6adc6nil5 реле
jqx-14fc_07 реле
jqx-14ff реле
jqx-14ff/012-1zw hongfa, dip 2010
jqx-14ff/121h реле
jqx-14ff/121hs реле
jqx-14ff/121z реле
jqx-14ff/121zs реле
jqx-14ff/181h реле
jqx-14ff/181hs реле
jqx-14ff/181z реле
jqx-14ff/181zs реле
jqx-14ff/241h реле
jqx-14ff/241hs реле
jqx-14ff/241z реле
jqx-14ff/241zs реле
jqx-14ff/31h реле
jqx-14ff/31hs реле
jqx-14ff/31z реле

jqx-14ff/31zs реле
jqx-14ff/481h реле
jqx-14ff/481hs реле
jqx-14ff/481z реле
jqx-14ff/481zs реле
jqx-14ff/51h реле
jqx-14ff/51hs реле
jqx-14ff/51z реле
jqx-14ff/51zs реле
jqx-14ff/601h реле
jqx-14ff/601hs реле
jqx-14ff/601z реле
jqx-14ff/601zs реле
jqx-14ff/61h реле
jqx-14ff/61hs реле
jqx-14ff/61z реле
jqx-14ff/61zs реле
jqx-14ff/91h реле
jqx-14ff/91hs реле
jqx-14ff/91z реле
jqx-14ff/91zs реле

jqx-14ff121hnil etc1 [list of unclassified manufacturers], single-pole, 10a, borad termina
jqx-14ff121hqc etc1 [list of unclassified manufacturers], single-pole, 10a, borad termina
jqx-14ff121hs etc1 [list of unclassified manufacturers], single-pole, 10a, borad termina
jqx-14ff121znil etc1 [list of unclassified manufacturers], single-pole, 10a, borad termina
jqx-14ff121zqc etc1 [list of unclassified manufacturers], single-pole, 10a, borad termina
jqx-14ff121zs etc1 [list of unclassified manufacturers], single-pole, 10a, borad termina
jqx-14ff181hnil etc1 [list of unclassified manufacturers], single-pole, 10a, borad termina

jqx-14ff181hqc etc1 [list of unclassified manufacturers], single-pole, 10a, borad termina
jqx-14ff181hs etc1 [list of unclassified manufacturers], single-pole, 10a, borad termina
jqx-14ff181znil etc1 [list of unclassified manufacturers], single-pole, 10a, borad termina
jqx-14ff181zqc etc1 [list of unclassified manufacturers], single-pole, 10a, borad termina
jqx-14ff181zs etc1 [list of unclassified manufacturers], single-pole, 10a, borad termina
jqx-14ff241hnil etc1 [list of unclassified manufacturers], single-pole, 10a, borad termina
jqx-14ff241hqc etc1 [list of unclassified manufacturers], single-pole, 10a, borad termina
jqx-14ff241hs etc1 [list of unclassified manufacturers], single-pole, 10a, borad termina
jqx-14ff241znil etc1 [list of unclassified manufacturers], single-pole, 10a, borad termina
jqx-14ff241zqc etc1 [list of unclassified manufacturers], single-pole, 10a, borad termina
jqx-14ff241zs etc1 [list of unclassified manufacturers], single-pole, 10a, borad termina
jqx-14ff31hnil etc1 [list of unclassified manufacturers], single-pole, 10a, borad termina
jqx-14ff31hqc etc1 [list of unclassified manufacturers], single-pole, 10a, borad termina
jqx-14ff31hs etc1 [list of unclassified manufacturers], single-pole, 10a, borad termina
jqx-14ff31znil etc1 [list of unclassified manufacturers], single-pole, 10a, borad termina
jqx-14ff31zqc etc1 [list of unclassified manufacturers], single-pole, 10a, borad termina
jqx-14ff31zs etc1 [list of unclassified manufacturers], single-pole, 10a, borad termina
jqx-14ff481hnil etc1 [list of unclassified manufacturers], single-pole, 10a, borad termina
jqx-14ff481hqc etc1 [list of unclassified manufacturers], single-pole, 10a, borad termina
jqx-14ff481hs etc1 [list of unclassified manufacturers], single-pole, 10a, borad termina
jqx-14ff481znil etc1 [list of unclassified manufacturers], single-pole, 10a, borad termina
jqx-14ff481zqc etc1 [list of unclassified manufacturers], single-pole, 10a, borad termina
jqx-14ff481zs etc1 [list of unclassified manufacturers], single-pole, 10a, borad termina
jqx-14ff51hnil etc1 [list of unclassified manufacturers], single-pole, 10a, borad termina
jqx-14ff51hqc etc1 [list of unclassified manufacturers], single-pole, 10a, borad termina
jqx-14ff51hs etc1 [list of unclassified manufacturers], single-pole, 10a, borad termina
jqx-14ff51znil etc1 [list of unclassified manufacturers], single-pole, 10a, borad termina
jqx-14ff51zqc etc1 [list of unclassified manufacturers], single-pole, 10a, borad termina

jqx-14ff51zs etc1 [list of unclassified manufacturers], single-pole, 10a, borad termina
jqx-14ff601hnil etc1 [list of unclassified manufacturers], single-pole, 10a, borad termina
jqx-14ff601hqc etc1 [list of unclassified manufacturers], single-pole, 10a, borad termina
jqx-14ff601hs etc1 [list of unclassified manufacturers], single-pole, 10a, borad termina
jqx-14ff601znil etc1 [list of unclassified manufacturers], single-pole, 10a, borad termina
jqx-14ff601zqc etc1 [list of unclassified manufacturers], single-pole, 10a, borad termina
jqx-14ff601zs etc1 [list of unclassified manufacturers], single-pole, 10a, borad termina
jqx-14ff61hnil etc1 [list of unclassified manufacturers], single-pole, 10a, borad termina
jqx-14ff61hqc etc1 [list of unclassified manufacturers], single-pole, 10a, borad termina
jqx-14ff61hs etc1 [list of unclassified manufacturers], single-pole, 10a, borad termina
jqx-14ff61znil etc1 [list of unclassified manufacturers], single-pole, 10a, borad termina
jqx-14ff61zqc etc1 [list of unclassified manufacturers], single-pole, 10a, borad termina
jqx-14ff61zs etc1 [list of unclassified manufacturers], single-pole, 10a, borad termina
jqx-14ff91hnil etc1 [list of unclassified manufacturers], single-pole, 10a, borad termina
jqx-14ff91hqc etc1 [list of unclassified manufacturers], single-pole, 10a, borad termina
jqx-14ff91hs etc1 [list of unclassified manufacturers], single-pole, 10a, borad termina
jqx-14ff91znil etc1 [list of unclassified manufacturers], single-pole, 10a, borad termina
jqx-14ff91zqc etc1 [list of unclassified manufacturers], single-pole, 10a, borad termina
jqx-14ff91zs etc1 [list of unclassified manufacturers], single-pole, 10a, borad termina
jqx-14fl-1c-12vdc -, количество в упаковке: 10 шт
jqx-14fw etc1 [list of unclassified manufacturers], single-pole, 20a, boar
jqx-14fw12dnlnil etc1 [list of unclassified manufacturers], single-pole, 20a, boar
jqx-14fw12dnlp etc1 [list of unclassified manufacturers], single-pole, 20a, boar
jqx-14fw12dsnil etc1 [list of unclassified manufacturers], single-pole, 20a, boar
jqx-14fw12dsp etc1 [list of unclassified manufacturers], single-pole, 20a, boar
jqx-14fw12hlnil etc1 [list of unclassified manufacturers], single-pole, 20a, boar
jqx-14fw12hnlp etc1 [list of unclassified manufacturers], single-pole, 20a, boar
jqx-14fw12hsnil etc1 [list of unclassified manufacturers], single-pole, 20a, boar

jqx-14fw12hsp etc1 [list of unclassified manufacturers], single-pole, 20a, boar
jqx-14fw12znilnil etc1 [list of unclassified manufacturers], single-pole, 20a, boar
jqx-14fw12znilp etc1 [list of unclassified manufacturers], single-pole, 20a, boar
jqx-14fw12zsnil etc1 [list of unclassified manufacturers], single-pole, 20a, boar
jqx-14fw12zsp etc1 [list of unclassified manufacturers], single-pole, 20a, boar
jqx-14fw18dnlnil etc1 [list of unclassified manufacturers], single-pole, 20a, boar
jqx-14fw18dnlp etc1 [list of unclassified manufacturers], single-pole, 20a, boar
jqx-14fw18dsnlnil etc1 [list of unclassified manufacturers], single-pole, 20a, boar
jqx-14fw18dsp etc1 [list of unclassified manufacturers], single-pole, 20a, boar
jqx-14fw18hlnlnil etc1 [list of unclassified manufacturers], single-pole, 20a, boar
jqx-14fw18hlnlp etc1 [list of unclassified manufacturers], single-pole, 20a, boar
jqx-14fw18hlnil etc1 [list of unclassified manufacturers], single-pole, 20a, boar
jqx-14fw18hsp etc1 [list of unclassified manufacturers], single-pole, 20a, boar
jqx-14fw18znilnil etc1 [list of unclassified manufacturers], single-pole, 20a, boar
jqx-14fw18znilp etc1 [list of unclassified manufacturers], single-pole, 20a, boar
jqx-14fw18zsnil etc1 [list of unclassified manufacturers], single-pole, 20a, boar
jqx-14fw18zsp etc1 [list of unclassified manufacturers], single-pole, 20a, boar
jqx-14fw24dnlnil etc1 [list of unclassified manufacturers], single-pole, 20a, boar
jqx-14fw24dnlp etc1 [list of unclassified manufacturers], single-pole, 20a, boar
jqx-14fw24dsnlnil etc1 [list of unclassified manufacturers], single-pole, 20a, boar
jqx-14fw24dsp etc1 [list of unclassified manufacturers], single-pole, 20a, boar
jqx-14fw24hlnlnil etc1 [list of unclassified manufacturers], single-pole, 20a, boar
jqx-14fw24hlnlp etc1 [list of unclassified manufacturers], single-pole, 20a, boar
jqx-14fw24hlnil etc1 [list of unclassified manufacturers], single-pole, 20a, boar
jqx-14fw24hsp etc1 [list of unclassified manufacturers], single-pole, 20a, boar
jqx-14fw24znilnil etc1 [list of unclassified manufacturers], single-pole, 20a, boar
jqx-14fw24znilp etc1 [list of unclassified manufacturers], single-pole, 20a, boar
jqx-14fw24zsnil etc1 [list of unclassified manufacturers], single-pole, 20a, boar

jqx-14fw24zsp etc1 [list of unclassified manufacturers], single-pole, 20a, boar
jqx-14fw48dnlnil etc1 [list of unclassified manufacturers], single-pole, 20a, boar
jqx-14fw48dnlp etc1 [list of unclassified manufacturers], single-pole, 20a, boar
jqx-14fw48dsnlnil etc1 [list of unclassified manufacturers], single-pole, 20a, boar
jqx-14fw48dsp etc1 [list of unclassified manufacturers], single-pole, 20a, boar
jqx-14fw48hlnlnil etc1 [list of unclassified manufacturers], single-pole, 20a, boar
jqx-14fw48hlnlp etc1 [list of unclassified manufacturers], single-pole, 20a, boar
jqx-14fw48hsnlnil etc1 [list of unclassified manufacturers], single-pole, 20a, boar
jqx-14fw48hsp etc1 [list of unclassified manufacturers], single-pole, 20a, boar
jqx-14fw48zlnlnil etc1 [list of unclassified manufacturers], single-pole, 20a, boar
jqx-14fw48zlnlp etc1 [list of unclassified manufacturers], single-pole, 20a, boar
jqx-14fw48zsnlnil etc1 [list of unclassified manufacturers], single-pole, 20a, boar
jqx-14fw48zsp etc1 [list of unclassified manufacturers], single-pole, 20a, boar
jqx-14fw5dnlnlnil etc1 [list of unclassified manufacturers], single-pole, 20a, boar
jqx-14fw5dnlp etc1 [list of unclassified manufacturers], single-pole, 20a, boar
jqx-14fw5dsnlnil etc1 [list of unclassified manufacturers], single-pole, 20a, boar
jqx-14fw5dsp etc1 [list of unclassified manufacturers], single-pole, 20a, boar
jqx-14fw5hlnlnil etc1 [list of unclassified manufacturers], single-pole, 20a, boar
jqx-14fw5hlnlp etc1 [list of unclassified manufacturers], single-pole, 20a, boar
jqx-14fw5hsnlnil etc1 [list of unclassified manufacturers], single-pole, 20a, boar
jqx-14fw5hsp etc1 [list of unclassified manufacturers], single-pole, 20a, boar
jqx-14fw5zlnlnil etc1 [list of unclassified manufacturers], single-pole, 20a, boar
jqx-14fw5zlnlp etc1 [list of unclassified manufacturers], single-pole, 20a, boar
jqx-14fw5zsnlnil etc1 [list of unclassified manufacturers], single-pole, 20a, boar
jqx-14fw5zsp etc1 [list of unclassified manufacturers], single-pole, 20a, boar
jqx-14fw60dnlnlnil etc1 [list of unclassified manufacturers], single-pole, 20a, boar
jqx-14fw60dnlp etc1 [list of unclassified manufacturers], single-pole, 20a, boar
jqx-14fw60dsnlnil etc1 [list of unclassified manufacturers], single-pole, 20a, boar

jqx-14fw60dsp etc1 [list of unclassified manufacturers], single-pole, 20a, boar
jqx-14fw60hnilnil etc1 [list of unclassified manufacturers], single-pole, 20a, boar
jqx-14fw60hnilp etc1 [list of unclassified manufacturers], single-pole, 20a, boar
jqx-14fw60hsnil etc1 [list of unclassified manufacturers], single-pole, 20a, boar
jqx-14fw60hsp etc1 [list of unclassified manufacturers], single-pole, 20a, boar
jqx-14fw60znilnil etc1 [list of unclassified manufacturers], single-pole, 20a, boar
jqx-14fw60znilp etc1 [list of unclassified manufacturers], single-pole, 20a, boar
jqx-14fw60zsnil etc1 [list of unclassified manufacturers], single-pole, 20a, boar
jqx-14fw60zsp etc1 [list of unclassified manufacturers], single-pole, 20a, boar
jqx-14fw6dnilnil etc1 [list of unclassified manufacturers], single-pole, 20a, boar
jqx-14fw6dnilp etc1 [list of unclassified manufacturers], single-pole, 20a, boar
jqx-14fw6dsnil etc1 [list of unclassified manufacturers], single-pole, 20a, boar
jqx-14fw6dsp etc1 [list of unclassified manufacturers], single-pole, 20a, boar
jqx-14fw6hnilnil etc1 [list of unclassified manufacturers], single-pole, 20a, boar
jqx-14fw6hnilp etc1 [list of unclassified manufacturers], single-pole, 20a, boar
jqx-14fw6hsnil etc1 [list of unclassified manufacturers], single-pole, 20a, boar
jqx-14fw6hsp etc1 [list of unclassified manufacturers], single-pole, 20a, boar
jqx-14fw6znilnil etc1 [list of unclassified manufacturers], single-pole, 20a, boar
jqx-14fw6znilp etc1 [list of unclassified manufacturers], single-pole, 20a, boar
jqx-14fw6zsnil etc1 [list of unclassified manufacturers], single-pole, 20a, boar
jqx-14fw6zsp etc1 [list of unclassified manufacturers], single-pole, 20a, boar
jqx-14fw9dnilnil etc1 [list of unclassified manufacturers], single-pole, 20a, boar
jqx-14fw9dnilp etc1 [list of unclassified manufacturers], single-pole, 20a, boar
jqx-14fw9dsnil etc1 [list of unclassified manufacturers], single-pole, 20a, boar
jqx-14fw9dsp etc1 [list of unclassified manufacturers], single-pole, 20a, boar
jqx-14fw9hnilnil etc1 [list of unclassified manufacturers], single-pole, 20a, boar
jqx-14fw9hnilp etc1 [list of unclassified manufacturers], single-pole, 20a, boar
jqx-14fw9hsnil etc1 [list of unclassified manufacturers], single-pole, 20a, boar

jqx-14fw9hsp etc1 [list of unclassified manufacturers], single-pole, 20a, boar

jqx-14fw9zniil etc1 [list of unclassified manufacturers], single-pole, 20a, boar

jqx-14fw9zniip etc1 [list of unclassified manufacturers], single-pole, 20a, boar

jqx-14fw9zsnil etc1 [list of unclassified manufacturers], single-pole, 20a, boar

jqx-14fw9zsp etc1 [list of unclassified manufacturers], single-pole, 20a, boar

jqx-15f

jqx-15f-24vdc-c hwe

jqx-15f-24vdc-c hwe, группа: реле, описание: 277vac / 28vdc, 20a, 30a, габариты: 32x27x20мм

jqx-15f-l-12v жи°екћ, dip 2010

jqx-15f-l-dc12v жи°екћ, dip 2010

jqx-29f-1c-12vdc wanjia electric

jqx-29f-1c-12vdc

jqx-29f-1c-24vdc wanjia electric

jqx-30f-1c-12vdc wanjia electric

jqx-30f-2c-12vdc группа: реле, описание: тип контактов: 2с; икатушки: 12в; ікомм: 30а, габариты: 38x36x48мм

jqx-30f-2c-12vdc

jqx-30f-2c-220vac

jqx-37f реле

jqx-37f0051h реле

jqx-37f0051ht реле

jqx-37f0061h реле

jqx-37f0061ht реле

jqx-37f0091h реле

jqx-37f0091ht реле

jqx-37f0121h реле

jqx-37f0121ht реле

jqx-37f0241h реле

jqx-37f0241ht реле

jqx-37f0481h реле

jqx-37f0481ht реле

jqx-37f0601h реле

jqx-37f0601ht реле

jqx-38fa-12v

jqx-40f-2z-ac220v

jqx-52f-1c-220vac wanjia electric

jqx-54fe dblectro [db lectro inc], compact high capacity relay for inductive load, rushing current 70a and steady-state current 20a

jqx-54fe/12h3nil реле

jqx-54fe/12h3t реле

jqx-54fe/24h3nil реле

jqx-54fe/24h3t реле

jqx-54fe/48h3nil реле

jqx-54fe/48h3t реле

jqx-54fe/5h3nil реле

jqx-54fe/5h3t реле

jqx-54fe/6h3nil реле

jqx-54fe/6h3t реле

jqx-54fea huaxinan [huaxinan electronics co.,ltd], can welded directly onto pc

jqx-54feaz20bdc12vc dblectro [db lectro inc], compact high capacity relay for inductive load, rushing current 70a and steady-state current 20a

jqx-54feaz20bdc24vc dblectro [db lectro inc], compact high capacity relay for inductive load, rushing current 70a and steady-state current 20a

jqx-54feaz20bdc48vc dblectro [db lectro inc], compact high capacity relay for inductive load, rushing current 70a and steady-state current 20a

jqx-54feaz20bdc6vc dblectro [db lectro inc], compact high capacity relay for inductive load, rushing current 70a and steady-state current 20a

jqx-54feaz20bdc9vc dblectro [db lectro inc], compact high capacity relay for inductive load, rushing current 70a and steady-state current 20a

jqx-54feaz250bdc12vc dblectro [db lectro inc], compact high capacity relay for inductive load, rushing current 70a and steady-state current 20a

jqx-54feaz250bdc24vc dblectro [db lectro inc], compact high capacity relay for inductive load, rushing current 70a and steady-state current 20a

jqx-54feaz250bdc48vc dblectro [db lectro inc], compact high capacity relay for inductive load, rushing current 70a and steady-state current 20a

jqx-54feaz250bdc6vc dblectro [db lectro inc], compact high capacity relay for inductive load, rushing current 70a and steady-state current 20a

jqx-54feaz250bdc9vc dblectro [db lectro inc], compact high capacity relay for inductive load, rushing current 70a and steady-state current 20a

jqx-54feaz25bdc12vc dblectro [db lectro inc], compact high capacity relay for inductive load, rushing current 70a and steady-state current 20a

jqx-54feaz25bdc24vc dblectro [db lectro inc], compact high capacity relay for inductive load, rushing current 70a and steady-state current 20a

jqx-54feaz25bdc48vc dblectro [db lectro inc], compact high capacity relay for inductive load, rushing current 70a and steady-state current 20a

jqx-54feaz25bdc6vc dblectro [db lectro inc], compact high capacity relay for inductive load, rushing current 70a and steady-state current 20a

jqx-54feaz25bdc9vc dblectro [db lectro inc], compact high capacity relay for inductive load, rushing current 70a and steady-state current 20a

jqx-54feaz277bdc12vc dblectro [db lectro inc], compact high capacity relay for inductive load, rushing current 70a and steady-state current 20a

jqx-54feaz277bdc24vc dblectro [db lectro inc], compact high capacity relay for inductive load, rushing current 70a and steady-state current 20a

jqx-54feaz277bdc48vc dblectro [db lectro inc], compact high capacity relay for inductive load, rushing current 70a and steady-state current 20a

jqx-54feaz277bdc6vc dblectro [db lectro inc], compact high capacity relay for inductive load, rushing current 70a and steady-state current 20a

jqx-54feaz277bdc9vc dblectro [db lectro inc], compact high capacity relay for inductive load, rushing current 70a and steady-state current 20a

jqx-54w реле

jqx-54wa20dc110vcb реле

jqx-54wa20dc110vcf реле

jqx-54wa20dc12vcb реле

jqx-54wa20dc12vcf	реле
jqx-54wa20dc24vcb	реле
jqx-54wa20dc24vcf	реле
jqx-54wa20dc48vcb	реле
jqx-54wa20dc48vcf	реле
jqx-54wa20dc5vcb	реле
jqx-54wa20dc5vcf	реле
jqx-54wa20dc6vcb	реле
jqx-54wa20dc6vcf	реле
jqx-54wa20dc9vcb	реле
jqx-54wa20dc9vcf	реле
jqx-54wa250dc110vcb	реле
jqx-54wa250dc110vcf	реле
jqx-54wa250dc12vcb	реле
jqx-54wa250dc12vcf	реле
jqx-54wa250dc24vcb	реле
jqx-54wa250dc24vcf	реле
jqx-54wa250dc48vcb	реле
jqx-54wa250dc48vcf	реле
jqx-54wa250dc5vcb	реле
jqx-54wa250dc5vcf	реле
jqx-54wa250dc6vcb	реле
jqx-54wa250dc6vcf	реле
jqx-54wa250dc9vcb	реле
jqx-54wa250dc9vcf	реле
jqx-54wa25dc110vcb	реле
jqx-54wa25dc110vcf	реле
jqx-54wa25dc12vcb	реле

jqx-54wa25dc12vcf	реле
jqx-54wa25dc24vcb	реле
jqx-54wa25dc24vcf	реле
jqx-54wa25dc48vcb	реле
jqx-54wa25dc48vcf	реле
jqx-54wa25dc5vcb	реле
jqx-54wa25dc5vcf	реле
jqx-54wa25dc6vcb	реле
jqx-54wa25dc6vcf	реле
jqx-54wa25dc9vcb	реле
jqx-54wa25dc9vcf	реле
jqx-54wa277dc110vcb	реле
jqx-54wa277dc110vcf	реле
jqx-54wa277dc12vcb	реле
jqx-54wa277dc12vcf	реле
jqx-54wa277dc24vcb	реле
jqx-54wa277dc24vcf	реле
jqx-54wa277dc48vcb	реле
jqx-54wa277dc48vcf	реле
jqx-54wa277dc5vcb	реле
jqx-54wa277dc5vcf	реле
jqx-54wa277dc6vcb	реле
jqx-54wa277dc6vcf	реле
jqx-54wa277dc9vcb	реле
jqx-54wa277dc9vcf	реле
jqx-58f-1c-12vdc pbf	wanjia electric
jqx-59f-1z-80a-220vac	wanjia electric
jqx-62-1c-12vdc	wanjia electric

jqx-62-1c-12vdc pbf	wanjia electric
jqx-62f реле	
jqx-62f-2c-12vdc	wanjia electric
jqx-62f/0051hf реле	
jqx-62f/0051hnil	реле
jqx-62f/0061hf реле	
jqx-62f/0061hnil	реле
jqx-62f/0091hf реле	
jqx-62f/0091hnil	реле
jqx-62f/0121hf реле	
jqx-62f/0121hnil	реле
jqx-62f/0181hf реле	
jqx-62f/0181hnil	реле
jqx-62f/0241hf реле	
jqx-62f/0241hnil	реле
jqx-62f/0481hf реле	
jqx-62f/0481hnil	реле
jqx-62faz16cdc12v	реле
jqx-62faz16cdc18v	реле
jqx-62faz16cdc24v	реле
jqx-62faz16cdc48v	реле
jqx-62faz16cdc5v	реле
jqx-62faz16cdc6v	реле
jqx-62faz16cdc9v	реле
jqx-62faz16dc12v	реле
jqx-62faz16dc18v	реле
jqx-62faz16dc24v	реле
jqx-62faz16dc48v	реле

jqx-62faz16dc5v	реле
jqx-62faz16dc6v	реле
jqx-62faz16dc9v	реле
jqx-62faz20cdc12v	реле
jqx-62faz20cdc18v	реле
jqx-62faz20cdc24v	реле
jqx-62faz20cdc48v	реле
jqx-62faz20cdc5v	реле
jqx-62faz20cdc6v	реле
jqx-62faz20cdc9v	реле
jqx-62faz20dc12v	реле
jqx-62faz20dc18v	реле
jqx-62faz20dc24v	реле
jqx-62faz20dc48v	реле
jqx-62faz20dc5v	реле
jqx-62faz20dc6v	реле
jqx-62faz20dc9v	реле
jqx-68	реле
jqx-68f	реле
jqx-68f-006-1hs-551	glenair
jqx-68f-012-1zs-551	glenair
jqx-68f-012-1zsb-555	glenair
jqx-68f-024-1zs hongfa, dip 2010	
jqx-68f-024-1zs-551	glenair
jqx-68f-024-1zsb-555	glenair
jqx-68f-12v-1zs hongfa, dip 2011	
jqx-68f-12vdc-1zs	hongfa, dip 2011
jqx-68f-1zs-12v hongfa, dip 2011	

jqx-68f-1zs-12vdc hongfa, dip 2011

jqx-68f-1zs-24v hongfa, dip 2011

jqx-68f-1zs-24vdc hongfa, dip 2011

jqx-68f-24v-1zs hongfa, dip 2011

jqx-68f-24vdc-1zs hongfa, dip 2011

jqx115-f etc1 [list of unclassified manufacturers], 16a pole board typ

jqx115-f-i etc1 [list of unclassified manufacturers], 16a pole board typ

jqx115f0121hs3 glenair

jqx115f024-2zs4 hongfa relay, jqx115f024-2zs4 miniature electromagnetic relays

jqx115f110vdc

jqx13f-1c-a-dc24v-1 группа: реле, описание: тип контактов:1с; катушки:24b; ток: 20а

jqx13f-1c-a-dc24v-1

jqx13f-2c-a-dc12v-1 группа: реле, описание: тип контактов:2с; катушки:12b; ток:10а

jqx14-ff etc1 [list of unclassified manufacturers], single-pole, 10a, board termina

s-8354a38mc-jqxt2g sii semiconductor corporation, ic reg boost 3.8v 0.3a sot23-5

s-8354a38mc-jqxt2u sii semiconductor corporation, ic reg boost 3.8v 0.3a sot23-5

smjq-xc95w4px seoul [seoul semiconductor], integrated led solutio

smjq-xca5w4px seoul [seoul semiconductor], integrated led solutio

wj175-3z socket [jqx-38fa] wanjia electric

14f1 (jqx-14f1) реле 12v / 10a, 12vdc

832-1a-c 24vdc реле 24в / 30а, 240v (jqx-15f, t90)

jqx-40f/2z-220vac реле

jqx-13f 220vac jqx-13f 220vac реле 2 группы 10а

jqx-13f 24vdc jqx-13f 24vdc реле 2 группы 10а

jqx40f1z jqx40f1z 12vdc реле 1 группа 40а

jqx60f2z jqx60f2z 220vac реле 2 группы 60а

13f-1 (jqx-13f1) 240vac 10а

14f1 (jqx-14f1) 12vdc 10а

s-8354a38mc-jqxt2g

14ff-2z-c3-2 (h=21mm) для реле hf-141fh, jqx-141ff hongfa, реле

14ff-2z-c3-3 (h=26mm) для реле hf140ff/hf14fw, jqx14fc. hf-115fp hongfa, реле

jqx-102f-az-20-dc12v-0.9 rohs forward, реле

jqx-13f-2c-a-12vdc-1 forward, реле

jqx-13f-2c-a-24vdc-1 forward, реле

jqx-13f-2c-a-ac220v-1l forward, реле

jqx-141ff-2c-16a-dc48v forward, реле

jqx-141ff-2c-z-5a-12vdc-0.54 forward, реле

jqx-141ff-2c-z-5a-24vdc-0.54 pbf forward, реле

jqx-141ff-2c-z-5a-48vdc-0.54 forward, реле

jqx-14fc-2c-24vac asiaon, реле

jqx-14fc-2c-24vdc asiaon, реле

jqx-14fc-2z-230vac asiaon, реле

jqx-14fc2-2c-z-5-dc12v-5 forward, реле

jqx-29f-1c-12vdc реле электромеханическое псг, реле

jqx-38f/3z-220vac 3гр перекл 250в 40а реле

jqx-40f/2z-220vac 2гр 250в 40а реле

jqx-58f-1c-12vdc реле электромеханическое псг, реле

jqx-80f/1z-220vac 1гр перекл 250в 80а реле

jqx-115f-005-1hs3f реле 5v (б/г) (hongfa)

jqx-118f 012-1zs1t (2005г.) (hf) без/упак

14ff-2z-c3-2 (h=21mm) для реле hf-141fh, jqx-141ff hongfa, панель для реле на дин-рейку

14ff-2z-c3-3 (h=26mm) для реле hf140ff/hf14fw, jqx14fc. hf-115fp hongfa, панель для реле на дин-рейку

jqx-102f-az-20-dc12v-0.9 rohs forward

jqx-13f-2c-a-12vdc-1 forward

jqx-13f-2c-a-24vdc-1 forward

jqx-13f-2c-a-ac220v-1l forward

jqx-141ff-2c-16a-dc48v forward

jqx-141ff-2c-z-5a-12vdc-0.54 forward, снято с производства. nt75 в замен.

jqx-141ff-2c-z-5a-24vdc-0.54 pbf forward, снято с производства. nt75 в замен.

jqx-141ff-2c-z-5a-48vdc-0.54 forward, снято с производства. nt75 в замен.

jqx-14fc-2c-24vac asiaon

jqx-14fc-2c-24vdc asiaon

jqx-14fc-2z-230vac asiaon

jqx-14fc2-2c-z-5-dc12v-5 forward

jqx-29f-1c-12vdc ncr

jqx-29f-1c-12vdc ncr, реле электромеханическое

jqx-30f/2z-12vdc реле, 2 переключающих контакта 250в 30а, катушка 12в постоянного напряжения потребление катушки 1.5w

jqx-30f/2z-220vac реле, 2 переключающих контакта 250в 30а, катушка 220в переменного напряжения, потребление катушки 2.5w

jqx-30f/2z-24vdc реле, 2 переключающих контакта 250в 30а, катушка 24в постоянного напряжения

jqx-38f/3z-220vac реле, 3 переключающих группы контактов 250в 30а, катушка 220в переменного напряжения

jqx-40f/2z-220vac реле, 2 переключающих контакта 250vac 40а, катушка 220в переменного напряжения

jqx-40f/2z-24vdc реле, 2 переключающих контакта 250vac 40а, катушка 24vdc постоянного напряжения

jqx-80f/1z-220vac реле, 1 переключающий контакт 250vac 80а

14ff-2z-c3-2 (h=21mm) для реле hf-141fh, jqx-141ff hongfa

14ff-2z-c3-3 (h=26mm) для реле hf140ff/hf14fw, jqx14fc. hf-115fp hongfa

jqx-102f-az-20-dc12v-0.9 rohs forward

jqx-13f-2c-a-12vdc-1 forward

jqx-13f-2c-a-24vdc-1 forward

jqx-13f-2c-a-ac220v-1l forward

jqx-141ff-2c-16a-dc48v forward

jqx-141ff-2c-z-5a-12vdc-0.54 forward

jqx-141ff-2c-z-5a-24vdc-0.54 pbf forward

jqx-141ff-2c-z-5a-48vdc-0.54 forward

jqx-14fc-2c-24vac asiaon

jqx-14fc-2c-24vdc asiaon

jqx-14fc-2z-230vac asiaon

jqx-14fc2-2c-z-5-dc12v-5 forward

jqx-29f-1c-12vdc ncr

jqx-29f-1c-24vdc ncr

jqx-30f/2z-220vac

jqx-40f/2z-220vac

jqx-62-1c-12vdc wanjia

14ff-2z-c3-2 (h=21mm) для реле hf-141fh, jqx-141ff hongfa, панель для реле на дин-рейку

14ff-2z-c3-3 (h=26mm) для реле hf140ff/hf14fw, jqx hongfa, 14ff-2z-c3-3 (h=26mm) для реле hf140ff/hf14fw, jqx14fc, hf-115fp, панель для реле на дин-рейку

jqx-102f-az-20-dc12v-0.9 rohs forward, 891wp-1a-c-12vdc, gi-s-112dmfh, jm1an-tmp-dc12v-f, g4a-1a-e 12vdc, trk-12vdc-sd-ap-r, ftr-k3jb012w, traf-12vdc-s-h, hf102f/12vdc, sfk-1-12dm, 948-1a-12d

jqx-12f-2z-ac220 2гр 250в 30а гориз. крепление

jqx-13f-2c-a-12vdc-1 forward, scl-dpdt-12vdc, 56.32.9.012.0000, hl2-h-dc12v-f, ly2, 12vdc, trl-12vdc-s-2c, hjq-2z/12vdc, hf13f/012-2z1, nrg51-2c-12vdc, sme-212dt, hk13f-dc12v-2cp, 951-2c-12d

jqx-13f-2c-a-24vdc-1 forward, scl-dpdt-24vdc, 56.32.9.024.0000, hl2-h-dc24v-f, ly2, 24vdc, trl-24vdc-s-2c, hjq-2z/24vdc, hf13f/024-2z1, nrg51-2c-24vdc, sme-224dt, hk13f-dc24v-2cp, 951-2c-24d

jqx-13f-2c-a-ac220v-1l forward, scl-l-dpdt-220vac, 56.32.8.230.0030, hl2-l-ac240v-f, ly2n, 220/240vac, trl-220vac-s-2cl, hjq-2z/ 220/240vac, hf13f/a220/240-2z1d, sme-2220atd, hk13f-ac220/240v-2cpl, 951-2c-240an

jqx-141ff-2c-16a-dc48v forward, подробную информацию уточняйте у наших менеджеров.

jqx-141ff-2c-z-5a-12vdc-0.54 forward, снято с производства. nt75 в замен., mi-ss-212l, jw2sn-dc12v, tri-12vdc-fx-2cl-m, tra3-l-12vdc-s-2z, nrp-13-c-12d-h, smi-s-212l, hk14fd-dc12v-h2cg, trih-12vdc-xx-2cm, nt75-2-c-z-8-dc12v-0.41-5.0, nt75-1-c-s-16-dc24v-0.41-5.0, n

jqx-141ff-2c-z-5a-24vdc-0.54 pbf forward, снято с производства. nt75 в замен., mi-ss-224l, jw2sn-dc24v, tri-24vdc-fx-2cl-m, tra3-l-24vdc-s-2z, nrp-13-c-24d-h, smi-s-224l, hk14fd-dc24v-h2cg, nt75-2c-z-8-dc24v-0.41-5.0, hf140ff/024-2zs3, hf140ff/024-2zt, hls-14f3-24vdc-c

jqx-141ff-2c-z-5a-48vdc-0.54 forward, снято с производства. nt75 в замен., mi-ss-248l, jw2sn-dc48v, tri-48vdc-fx-2cl-m, tra3-l-48vdc-s-2z, nrp-13-c-48d-h, smi-s-248l, hk14fd-dc48v-h2c

г.Минск www.fotorele.net www.tiristor.by email mins17@tut.by тел.+375447584780

jqx-14fc-2c-230vac asiaon, подробную информацию уточняйте у наших менеджеров.

jqx-14fc-2c-24vac asiaon, подробную информацию уточняйте у наших менеджеров.

jqx-14fc-2c-24vdc asiaon, подробную информацию уточняйте у наших менеджеров.

jqx-14fc2-2c-z-5-dc12v-5 forward, trih-12vdc-xx-2cm, hf140ff/012-2z, jqx-141ff-2c-z-5a-12vdc-0.54

jqx-29f-1c-12vdc ncr

jqx-30f/2z-220vac 2гр 250в 30а

jqx-40f/2z-220vac 2гр 250в 40а

14ff-2z-c3-2 (h=21mm) для реле hf-141fh, jqx-141ff hongfa

14ff-2z-c3-3 (h=26mm) для реле hf140ff/hf14fw, jqx14fc. hf-115fp hongfa

jqx-102f-az-20-dc12v-0.9 rohs forward

jqx-115f-005-1hs3f реле 5v hongfa

jqx-118f 012-1zs1t hf

jqx-13f-2c-a-12vdc-1 forward

jqx-13f-2c-a-24vdc-1 forward

jqx-13f-2c-a-ac220v-1l forward

jqx-141ff-2c-16a-dc48v forward

jqx-141ff-2c-z-5a-12vdc-0.54 forward

jqx-141ff-2c-z-5a-24vdc-0.54 pbf forward

jqx-141ff-2c-z-5a-48vdc-0.54 forward

jqx-14fc-2c-24vac asiaon

jqx-14fc-2c-24vdc asiaon

jqx-14fc-2z-230vac asiaon

jqx-14fc2-2c-z-5-dc12v-5 forward

jqx-29f-1c-12vdc ncr

jqx-29f-1c-24vdc ncr

jqx-30f/2z-220vac

jqx-40f/2z-220vac

jqx-58f-1c-12vdc ncr

jqx-62-1c-12vdc wanjia
реле jqx-14f1 5vdc 10a
реле jqx-30f/2z 220vac
14ff2zc32(h=21mm)длярелеhf141fhjqx141ff hongfa electroacoustic xiamen
dsl3510lsjqx intel
jqx13f2ca12vdc1 forward relay
jqx13f2ca24vdc1 forward relay
jqx13f2caac220v1l forward relay
jqx141ff2cz5a12vdc054 forward relay
jqx141ff2cz5a24vdc054 forward relay
jqx141ff2cz5a48vdc054 forward relay
jqx14fc22cz5dc12v5 forward relay
jqx29f1c12vdc ncr industrial and electrical components
jqx29f1c24vdc ncr industrial and electrical components
13f-1 (jqx-13f1) 12vdc 10a
13f-1 (jqx-13f1) 240vac 10a
13f-1 (jqx-13f1) 24vdc 10a
14f1 (jqx-14f1) 12vdc 10a
14f1 (jqx-14f1) 12vdc 10a
14f1 (jqx-14f1) 24vdc 10a
14f1 (jqx-14f1) 5vdc 10a
14f1 (jqx-14f1) реле 12v / 10a, 12vdc
14ff-2z-c3-2 (h=21mm) для реле hf-141fh, jqx-141ff
14ff-2z-c3-3 (h=26mm) для реле hf140ff/hf14fw, jqx14fc. hf-115fp
832-1a-c 24vdc реле 24в / 30а, 240v (jqx-15f, t90)
jqx-102f-az-20-dc12v-0.9 rohs
jqx-115f-005-1hs3f реле 5v (б/гр)
jqx-115f-005-1hs3f реле 5вб/г

jqx-13f 220vac

jqx-13f 24vdc

jqx-13f 4z (3a/220в)

jqx-13f-2c-a-12vdc-1

jqx-13f-2c-a-24vdc-1

jqx-13f-2c-a-ac220v-1l

jqx-141ff-2c-16a-dc48v

jqx-141ff-2c-z-5a-12vdc-0.54

jqx-141ff-2c-z-5a-24vdc-0.54 pbf

jqx-141ff-2c-z-5a-48vdc-0.54

jqx-14fc-2c-24vac

jqx-14fc-2c-24vdc

jqx-14fc-2z-230vac

jqx-14fc2-2c-z-5-dc12v-5

jqx-29f-1c-12vdc

jqx-30f/2z-220vac

jqx-38f/3z-220vac

jqx-40f/2z-220vac

jqx-58f-1c-12vdc

jqx-68f-024-1zst, реле 24vdc, 8a/250vac

jqx-80f/1z-220vac

jqx40f1z

jqx60f2z

wj175-3z socket [jqx-38fa]

реле ~220vac 30a 2+6 pin jqx-30f/2z-220vac два перекидных контакта. на заказ

реле 12v 10a 8 pin (общ. назнач.) (под ptf08a-01) jqx-13f-1c

реле 12v 16/20a 4 pin+2 клеммы (на плату) jqx-62f 012-1h(555) на водонагреватель

реле 12v 16/20a 4 pin+2 клеммы (на плату) jqx-62f 012-1h(555) на водонагреватель от 3шт

реле 12v 30a 4 pin (на плату) jqx-105f-1-012d-1hs (jt105f-1-012d-1hs t90)

реле 12v 30a 6pin (на плату) jqx-15f (t90) (832)=t9as1d12-12=832a-1a-c-b 12v

реле 24v 5 pin (на плату) az761-1c-24de 12a (jqx-14f1)

реле 24v 5 pin (на плату) az761-1cb-24d 12a (jqx-14f1)

реле 24v 5 pin (на плату) az761-1cb-24de 12a (jqx-14f1)

реле 24v 5 pin (на плату) frm10n-1cs1 dc24v 12a (jqx-14f1)

реле 24v 5 pin (на плату) jqx-115f 024-1zs1(551) 12a (jqx-14f1)

реле 24v 60a 2 pin +3 клеммы hhc71g-1c-24vdc 250vac jqx-60f-1z под динрейку

реле 48v 30a 6pin (на плату) jqx-15f(t90)-1h

реле 48v 4 pin (на плату) 457170480310 16a 250v finder =hf115f-q / 048-1h jqx-115f-q (hf115f-q) 048-1h (555) 48vdc 18a 250vac 4pin

реле 5v 5 pin (на плату) jqx-14fc-1z dc5v 10a

реле 5v 5 pin (на плату) smi-05vdc-sl-c 10a (jqx-14f1)

реле 5v 8 pin (на плату) smih-05vdc-sl-c 16a (jqx-14f2)

реле jqx-13f 4z (3a/220в)

реле имп. 24v jqx-141ff-2c-z

реле~220v ac 10a 8 pin (общ. назнач.) jqx-13f-2 (под ptf08a-01)

реле~220vac 30a (2 клеммы +2клеммы) jqx-105f-4 / 220ak-1hs (hf105f-4)

14ff-2z-c3-2 (h=21mm) для реле hf-141fh, jqx-141ff hongfa

14ff-2z-c3-3 (h=26mm) для реле hf140ff/hf14fw, jqx14fc. hf-115fp hongfa

jqx-102f-az-20-dc12v-0.9 rohs forward

jqx-115f-005-1hs3f реле 5v hongfa

jqx-118f 012-1zs1t hf

jqx-13f-2c-a-12vdc-1 forward

jqx-13f-2c-a-24vdc-1 forward

jqx-13f-2c-a-ac220v-1l forward

jqx-141ff-2c-16a-dc48v forward

jqx-141ff-2c-z-5a-12vdc-0.54 forward

jqx-141ff-2c-z-5a-24vdc-0.54 pbf forward

jqx-141ff-2c-z-5a-48vdc-0.54 forward

jqx-14fc-2c-24vac asiaon

jqx-14fc-2c-24vdc asiaon

jqx-14fc-2z-230vac asiaon

jqx-14fc2-2c-z-5-dc12v-5 forward

jqx-29f-1c-12vdc ncr

jqx-29f-1c-24vdc ncr

jqx-30f/2z-220vac

jqx-40f/2z-220vac

jqx-58f-1c-12vdc ncr

jqx-62-1c-12vdc wanjia

реле jqx-14f1 5vdc 10a

реле jqx-30f/2z 220vac

13f-1 (jqx-13f1) 240vac 10a

13f-1 (jqx-13f1) 24vdc 10a

14f1 (jqx-14f1) 12vdc 10a

14ff-2z-c3-2 (h=21mm) для реле hf-141fh, jqx-141ff hongfa, панель для реле на дин-рейку

14ff-2z-c3-3 (h=26mm) для реле hf140ff/hf14fw, jqx14fc, hf-115fp hongfa, панель для реле на дин-рейку

jqx-13f-2c-a-24vdc-1 forward electronics

jqx-13f-2c-a-ac220v-1l forward electronics

jqx-141ff-2c-z-5a-24vdc-0.54 pbf forward electronics, снято с производства. nt75 в замен.

jqx-141ff-2c-z-5a-48vdc-0.54 forward electronics, снято с производства. nt75 в замен.

jqx-14fc-2c-24vac asiaon

jqx-14fc-2c-24vdc asiaon

jqx-14fc2-2c-z-5-dc12v-5 forward electronics

jqx-29f-1c-12vdc ncr

jqx-30f/2z-220vac 2гр 250в 30а. jqx-30f/2z-220vac

jqx-30f/2z-220vac wanjia

jqx-38f/3z-220vac 3гр перекл 250в 40а.

jqx-40f/2z-220vac 2гр 250в 40а.

jqx-58f-1c-12vdc ncr

jqx-80f/1z-220vac 1гр перекл 250в 80а.

acvx1220-freq-l-j-qxx abрасон

dsl3510l s ljqx intel, ис, контроллер интерфейса ввода вывода thunderbolt - 4 ch controller fc-csp288

hnc68a(jqx-13f)-2z-24vdc glenair, available

jqx-102f реле

jqx-102f/012 hongfa, dip 2006

jqx-102f005 реле

jqx-102f012 реле

jqx-102f024 реле

jqx-102f048 реле

jqx-102faz20bdc12c0.9 реле,

jqx-102faz20bdc12v0.9 dblectro [db lectro inc], used in household appliance like air conditioning , .

jqx-102faz20bdc24c0.9 реле,

jqx-102faz20bdc24v0.9 dblectro [db lectro inc], used in household appliance like air conditioning , .

jqx-102faz20bdc48c0.9 реле,

jqx-102faz20bdc48v0.9 dblectro [db lectro inc], used in household appliance like air conditioning , .

jqx-102faz20bdc5c0.9 реле,

jqx-102faz20bdc5v0.9 dblectro [db lectro inc], used in household appliance like air conditioning , .

jqx-102faz20nildc12v0.9 dblectro [db lectro inc], used in household appliance like air conditioning , .

jqx-102faz20nildc24v0.9 dblectro [db lectro inc], used in household appliance like air conditioning , .

jqx-102faz20nildc48v0.9 dblectro [db lectro inc], used in household appliance like air conditioning , .

jqx-102faz20nildc5v0.9 dblectro [db lectro inc], used in household appliance like air conditioning , .

jqx-102faz250bdc12c0.9 реле,

jqx-102faz250bdc24c0.9 реле,
jqx-102faz250bdc48c0.9 реле,
jqx-102faz250bdc5c0.9 реле,
jqx-102fp005 реле
jqx-102fp012 реле
jqx-102fp024 реле
jqx-102fp048 реле
jqx-102fpt005 реле
jqx-102fpt012 реле
jqx-102fpt024 реле
jqx-102fpt048 реле
jqx-102ft005 реле
jqx-102ft012 реле
jqx-102ft024 реле
jqx-102ft048 реле
jqx-102f_05 реле,
jqx-105-4lack1dnil реле
jqx-105-4lack1ds реле
jqx-105-4lack1hnil реле
jqx-105-4lack1hs реле
jqx-105-4lack1znil реле
jqx-105-4lack1zs реле
jqx-105-4lacnil1dnil реле
jqx-105-4lacnil1ds реле
jqx-105-4lacnil1hnil реле
jqx-105-4lacnil1hs реле
jqx-105-4lacnil1znil реле
jqx-105-4lacnil1zs реле

jqx-105-4ldck1dnil	реле	
jqx-105-4ldck1ds	реле	
jqx-105-4ldck1hnil	реле	
jqx-105-4ldck1hs	реле	
jqx-105-4ldck1znil	реле	
jqx-105-4ldck1zs	реле	
jqx-105-4ldcnil1dnil	реле	
jqx-105-4ldcnil1ds	реле	
jqx-105-4ldcnil1hnil	реле	
jqx-105-4ldcnil1hs	реле	
jqx-105-4ldcnil1znil	реле	
jqx-105-4ldcnil1zs	реле	
jqx-105f-1	реле	
jqx-105f-1-012-d1hst-555		glenair
jqx-105f-1018a61dstf	реле	
jqx-105f-1018a61hstf	реле	
jqx-105f-1018a61zstf	реле	
jqx-105f-1018at1dstf	реле	
jqx-105f-1018at1hstf	реле	
jqx-105f-1018at1zstf	реле	
jqx-105f-1018d61dstf	реле	
jqx-105f-1018d61hstf	реле	
jqx-105f-1018d61zstf	реле	
jqx-105f-1018dt1dstf	реле	
jqx-105f-1018dt1hstf	реле	
jqx-105f-1018dt1zstf	реле	
jqx-105f-2	etc1 [list of unclassified manufacturers], 30a 1 pole pcb&qс terminals	
jqx-105f-2l	etc1 [list of unclassified manufacturers], 30a 1 pole pcb&qс terminals	

jqx-105f-4	реле
jqx-105f-4/005d1d	реле
jqx-105f-4/005d1df	реле
jqx-105f-4/005d1dt	реле
jqx-105f-4/005d1dtf	реле
jqx-105f-4/005d1h	реле
jqx-105f-4/005d1hf	реле
jqx-105f-4/005d1ht	реле
jqx-105f-4/005d1htf	реле
jqx-105f-4/005d1z	реле
jqx-105f-4/005d1zf	реле
jqx-105f-4/005d1zt	реле
jqx-105f-4/005d1ztf	реле
jqx-105f-4/005dk1d	реле
jqx-105f-4/005dk1df	реле
jqx-105f-4/005dk1dt	реле
jqx-105f-4/005dk1dtf	реле
jqx-105f-4/005dk1h	реле
jqx-105f-4/005dk1hf	реле
jqx-105f-4/005dk1ht	реле
jqx-105f-4/005dk1htf	реле
jqx-105f-4/005dk1z	реле
jqx-105f-4/005dk1zf	реле
jqx-105f-4/005dk1zt	реле
jqx-105f-4/005dk1ztf	реле
jqx-105f-4/009d1d	реле
jqx-105f-4/009d1df	реле
jqx-105f-4/009d1dt	реле

jqx-105f-4/009d1dtf	реле
jqx-105f-4/009d1h	реле
jqx-105f-4/009d1hf	реле
jqx-105f-4/009d1ht	реле
jqx-105f-4/009d1htf	реле
jqx-105f-4/009d1z	реле
jqx-105f-4/009d1zf	реле
jqx-105f-4/009d1zt	реле
jqx-105f-4/009d1ztf	реле
jqx-105f-4/009dk1d	реле
jqx-105f-4/009dk1df	реле
jqx-105f-4/009dk1dt	реле
jqx-105f-4/009dk1dtf	реле
jqx-105f-4/009dk1h	реле
jqx-105f-4/009dk1hf	реле
jqx-105f-4/009dk1ht	реле
jqx-105f-4/009dk1htf	реле
jqx-105f-4/009dk1z	реле
jqx-105f-4/009dk1zf	реле
jqx-105f-4/009dk1zt	реле
jqx-105f-4/009dk1ztf	реле
jqx-105f-4/012a1d	реле
jqx-105f-4/012a1df	реле
jqx-105f-4/012a1dt	реле
jqx-105f-4/012a1dtf	реле
jqx-105f-4/012a1h	реле
jqx-105f-4/012a1hf	реле
jqx-105f-4/012a1ht	реле

jqx-105f-4/012a1htf	реле
jqx-105f-4/012a1z	реле
jqx-105f-4/012a1zf	реле
jqx-105f-4/012a1zt	реле
jqx-105f-4/012a1ztf	реле
jqx-105f-4/012ak1d	реле
jqx-105f-4/012ak1df	реле
jqx-105f-4/012ak1dt	реле
jqx-105f-4/012ak1dtf	реле
jqx-105f-4/012ak1h	реле
jqx-105f-4/012ak1hf	реле
jqx-105f-4/012ak1ht	реле
jqx-105f-4/012ak1htf	реле
jqx-105f-4/012ak1z	реле
jqx-105f-4/012ak1zf	реле
jqx-105f-4/012ak1zt	реле
jqx-105f-4/012ak1ztf	реле
jqx-105f-4/018d1d	реле
jqx-105f-4/018d1df	реле
jqx-105f-4/018d1dt	реле
jqx-105f-4/018d1dtf	реле
jqx-105f-4/018d1h	реле
jqx-105f-4/018d1hf	реле
jqx-105f-4/018d1ht	реле
jqx-105f-4/018d1htf	реле
jqx-105f-4/018d1z	реле
jqx-105f-4/018d1zf	реле
jqx-105f-4/018d1zt	реле

jqx-105f-4/018d1ztf	реле
jqx-105f-4/018dk1d	реле
jqx-105f-4/018dk1df	реле
jqx-105f-4/018dk1dt	реле
jqx-105f-4/018dk1dtf	реле
jqx-105f-4/018dk1h	реле
jqx-105f-4/018dk1hf	реле
jqx-105f-4/018dk1ht	реле
jqx-105f-4/018dk1htf	реле
jqx-105f-4/018dk1z	реле
jqx-105f-4/018dk1zf	реле
jqx-105f-4/018dk1zt	реле
jqx-105f-4/018dk1ztf	реле
jqx-105f-4/024a1d	реле
jqx-105f-4/024a1df	реле
jqx-105f-4/024a1dt	реле
jqx-105f-4/024a1dtf	реле
jqx-105f-4/024a1h	реле
jqx-105f-4/024a1hf	реле
jqx-105f-4/024a1ht	реле
jqx-105f-4/024a1htf	реле
jqx-105f-4/024a1z	реле
jqx-105f-4/024a1zf	реле
jqx-105f-4/024a1zt	реле
jqx-105f-4/024a1ztf	реле
jqx-105f-4/024ak1d	реле
jqx-105f-4/024ak1df	реле
jqx-105f-4/024ak1dt	реле

jqx-105f-4/024ak1dtf	реле
jqx-105f-4/024ak1h	реле
jqx-105f-4/024ak1hf	реле
jqx-105f-4/024ak1ht	реле
jqx-105f-4/024ak1htf	реле
jqx-105f-4/024ak1z	реле
jqx-105f-4/024ak1zf	реле
jqx-105f-4/024ak1zt	реле
jqx-105f-4/024ak1ztf	реле
jqx-105f-4/048d1d	реле
jqx-105f-4/048d1df	реле
jqx-105f-4/048d1dt	реле
jqx-105f-4/048d1dtf	реле
jqx-105f-4/048d1h	реле
jqx-105f-4/048d1hf	реле
jqx-105f-4/048d1ht	реле
jqx-105f-4/048d1htf	реле
jqx-105f-4/048d1z	реле
jqx-105f-4/048d1zf	реле
jqx-105f-4/048d1zt	реле
jqx-105f-4/048d1ztf	реле
jqx-105f-4/048dk1d	реле
jqx-105f-4/048dk1df	реле
jqx-105f-4/048dk1dt	реле
jqx-105f-4/048dk1dtf	реле
jqx-105f-4/048dk1h	реле
jqx-105f-4/048dk1hf	реле
jqx-105f-4/048dk1ht	реле

jqx-105f-4/048dk1htf	реле
jqx-105f-4/048dk1z	реле
jqx-105f-4/048dk1zf	реле
jqx-105f-4/048dk1zt	реле
jqx-105f-4/048dk1ztf	реле
jqx-105f-4/070d1d	реле
jqx-105f-4/070d1df	реле
jqx-105f-4/070d1dt	реле
jqx-105f-4/070d1dtf	реле
jqx-105f-4/070d1h	реле
jqx-105f-4/070d1hf	реле
jqx-105f-4/070d1ht	реле
jqx-105f-4/070d1htf	реле
jqx-105f-4/070d1z	реле
jqx-105f-4/070d1zf	реле
jqx-105f-4/070d1zt	реле
jqx-105f-4/070d1ztf	реле
jqx-105f-4/070dk1d	реле
jqx-105f-4/070dk1df	реле
jqx-105f-4/070dk1dt	реле
jqx-105f-4/070dk1dtf	реле
jqx-105f-4/070dk1h	реле
jqx-105f-4/070dk1hf	реле
jqx-105f-4/070dk1ht	реле
jqx-105f-4/070dk1htf	реле
jqx-105f-4/070dk1z	реле
jqx-105f-4/070dk1zf	реле
jqx-105f-4/070dk1zt	реле

jqx-105f-4/070dk1ztf	реле
jqx-105f-4/110d1d	реле
jqx-105f-4/110d1df	реле
jqx-105f-4/110d1dt	реле
jqx-105f-4/110d1dtf	реле
jqx-105f-4/110d1h	реле
jqx-105f-4/110d1hf	реле
jqx-105f-4/110d1ht	реле
jqx-105f-4/110d1htf	реле
jqx-105f-4/110d1z	реле
jqx-105f-4/110d1zf	реле
jqx-105f-4/110d1zt	реле
jqx-105f-4/110d1ztf	реле
jqx-105f-4/110dk1d	реле
jqx-105f-4/110dk1df	реле
jqx-105f-4/110dk1dt	реле
jqx-105f-4/110dk1dtf	реле
jqx-105f-4/110dk1h	реле
jqx-105f-4/110dk1hf	реле
jqx-105f-4/110dk1ht	реле
jqx-105f-4/110dk1htf	реле
jqx-105f-4/110dk1z	реле
jqx-105f-4/110dk1zf	реле
jqx-105f-4/110dk1zt	реле
jqx-105f-4/110dk1ztf	реле
jqx-105f-4/120a1d	реле
jqx-105f-4/120a1df	реле
jqx-105f-4/120a1dt	реле

jqx-105f-4/120a1dtf	реле
jqx-105f-4/120a1h	реле
jqx-105f-4/120a1hf	реле
jqx-105f-4/120a1ht	реле
jqx-105f-4/120a1htf	реле
jqx-105f-4/120a1z	реле
jqx-105f-4/120a1zf	реле
jqx-105f-4/120a1zt	реле
jqx-105f-4/120a1ztf	реле
jqx-105f-4/120ak1d	реле
jqx-105f-4/120ak1df	реле
jqx-105f-4/120ak1dt	реле
jqx-105f-4/120ak1dtf	реле
jqx-105f-4/120ak1h	реле
jqx-105f-4/120ak1hf	реле
jqx-105f-4/120ak1ht	реле
jqx-105f-4/120ak1htf	реле
jqx-105f-4/120ak1z	реле
jqx-105f-4/120ak1zf	реле
jqx-105f-4/120ak1zt	реле
jqx-105f-4/120ak1ztf	реле
jqx-105f-4/277a1d	реле
jqx-105f-4/277a1df	реле
jqx-105f-4/277a1dt	реле
jqx-105f-4/277a1dtf	реле
jqx-105f-4/277a1h	реле
jqx-105f-4/277a1hf	реле
jqx-105f-4/277a1ht	реле

jqx-105f-4/277a1htf	реле
jqx-105f-4/277a1z	реле
jqx-105f-4/277a1zf	реле
jqx-105f-4/277a1zt	реле
jqx-105f-4/277a1ztf	реле
jqx-105f-4/277ak1d	реле
jqx-105f-4/277ak1df	реле
jqx-105f-4/277ak1dt	реле
jqx-105f-4/277ak1dtf	реле
jqx-105f-4/277ak1h	реле
jqx-105f-4/277ak1hf	реле
jqx-105f-4/277ak1ht	реле
jqx-105f-4/277ak1htf	реле
jqx-105f-4/277ak1z	реле
jqx-105f-4/277ak1zf	реле
jqx-105f-4/277ak1zt	реле
jqx-105f-4/277ak1ztf	реле
jqx-105f-4ack1dnil	реле
jqx-105f-4ack1ds	реле
jqx-105f-4ack1hnil	реле
jqx-105f-4ack1hs	реле
jqx-105f-4ack1znil	реле
jqx-105f-4ack1zs	реле
jqx-105f-4acnil1dnil	реле
jqx-105f-4acnil1ds	реле
jqx-105f-4acnil1hnil	реле
jqx-105f-4acnil1hs	реле
jqx-105f-4acnil1znil	реле

jqx-105f-4acnil1zs	реле
jqx-105f-4dck1dnil	реле
jqx-105f-4dck1ds	реле
jqx-105f-4dck1hnil	реле
jqx-105f-4dck1hs	реле
jqx-105f-4dck1znil	реле
jqx-105f-4dck1zs	реле
jqx-105f-4dcnil1dnil	реле
jqx-105f-4dcnil1ds	реле
jqx-105f-4dcnil1hnil	реле
jqx-105f-4dcnil1hs	реле
jqx-105f-4dcnil1znil	реле
jqx-105f-4dcnil1zs	реле
jqx-105f-4l/005d1d	реле
jqx-105f-4l/005d1df	реле
jqx-105f-4l/005d1dt	реле
jqx-105f-4l/005d1dtf	реле
jqx-105f-4l/005d1h	реле
jqx-105f-4l/005d1hf	реле
jqx-105f-4l/005d1ht	реле
jqx-105f-4l/005d1htf	реле
jqx-105f-4l/005d1z	реле
jqx-105f-4l/005d1zf	реле
jqx-105f-4l/005d1zt	реле
jqx-105f-4l/005d1ztf	реле
jqx-105f-4l/005dk1d	реле
jqx-105f-4l/005dk1df	реле
jqx-105f-4l/005dk1dt	реле

jqx-105f-4l/005dk1dtf реле
jqx-105f-4l/005dk1h реле
jqx-105f-4l/005dk1hf реле
jqx-105f-4l/005dk1ht реле
jqx-105f-4l/005dk1htf реле
jqx-105f-4l/005dk1z реле
jqx-105f-4l/005dk1zf реле
jqx-105f-4l/005dk1zt реле
jqx-105f-4l/005dk1ztf реле
jqx-105f-4l/009d1d реле
jqx-105f-4l/009d1df реле
jqx-105f-4l/009d1dt реле
jqx-105f-4l/009d1dtf реле
jqx-105f-4l/009d1h реле
jqx-105f-4l/009d1hf реле
jqx-105f-4l/009d1ht реле
jqx-105f-4l/009d1htf реле
jqx-105f-4l/009d1z реле
jqx-105f-4l/009d1zf реле
jqx-105f-4l/009d1zt реле
jqx-105f-4l/009d1ztf реле
jqx-105f-4l/009dk1d реле
jqx-105f-4l/009dk1df реле
jqx-105f-4l/009dk1dt реле
jqx-105f-4l/009dk1dtf реле
jqx-105f-4l/009dk1h реле
jqx-105f-4l/009dk1hf реле
jqx-105f-4l/009dk1ht реле

jqx-105f-4l/009dk1htf реле
jqx-105f-4l/009dk1z реле
jqx-105f-4l/009dk1zf реле
jqx-105f-4l/009dk1zt реле
jqx-105f-4l/009dk1ztf реле
jqx-105f-4l/012a1d реле
jqx-105f-4l/012a1df реле
jqx-105f-4l/012a1dt реле
jqx-105f-4l/012a1dtf реле
jqx-105f-4l/012a1h реле
jqx-105f-4l/012a1hf реле
jqx-105f-4l/012a1ht реле
jqx-105f-4l/012a1htf реле
jqx-105f-4l/012a1z реле
jqx-105f-4l/012a1zf реле
jqx-105f-4l/012a1zt реле
jqx-105f-4l/012a1ztf реле
jqx-105f-4l/012ak1d реле
jqx-105f-4l/012ak1df реле
jqx-105f-4l/012ak1dt реле
jqx-105f-4l/012ak1dtf реле
jqx-105f-4l/012ak1h реле
jqx-105f-4l/012ak1hf реле
jqx-105f-4l/012ak1ht реле
jqx-105f-4l/012ak1htf реле
jqx-105f-4l/012ak1z реле
jqx-105f-4l/012ak1zf реле
jqx-105f-4l/012ak1zt реле

jqx-105f-4l/012ak1ztf	реле
jqx-105f-4l/018d1d	реле
jqx-105f-4l/018d1df	реле
jqx-105f-4l/018d1dt	реле
jqx-105f-4l/018d1dtf	реле
jqx-105f-4l/018d1h	реле
jqx-105f-4l/018d1hf	реле
jqx-105f-4l/018d1ht	реле
jqx-105f-4l/018d1htf	реле
jqx-105f-4l/018d1z	реле
jqx-105f-4l/018d1zf	реле
jqx-105f-4l/018d1zt	реле
jqx-105f-4l/018d1ztf	реле
jqx-105f-4l/018dk1d	реле
jqx-105f-4l/018dk1df	реле
jqx-105f-4l/018dk1dt	реле
jqx-105f-4l/018dk1dtf	реле
jqx-105f-4l/018dk1h	реле
jqx-105f-4l/018dk1hf	реле
jqx-105f-4l/018dk1ht	реле
jqx-105f-4l/018dk1htf	реле
jqx-105f-4l/018dk1z	реле
jqx-105f-4l/018dk1zf	реле
jqx-105f-4l/018dk1zt	реле
jqx-105f-4l/018dk1ztf	реле
jqx-105f-4l/024a1d	реле
jqx-105f-4l/024a1df	реле
jqx-105f-4l/024a1dt	реле

jqx-105f-4l/024a1dtf	реле
jqx-105f-4l/024a1h	реле
jqx-105f-4l/024a1hf	реле
jqx-105f-4l/024a1ht	реле
jqx-105f-4l/024a1htf	реле
jqx-105f-4l/024a1z	реле
jqx-105f-4l/024a1zf	реле
jqx-105f-4l/024a1zt	реле
jqx-105f-4l/024a1ztf	реле
jqx-105f-4l/024ak1d	реле
jqx-105f-4l/024ak1df	реле
jqx-105f-4l/024ak1dt	реле
jqx-105f-4l/024ak1dtf	реле
jqx-105f-4l/024ak1h	реле
jqx-105f-4l/024ak1hf	реле
jqx-105f-4l/024ak1ht	реле
jqx-105f-4l/024ak1htf	реле
jqx-105f-4l/024ak1z	реле
jqx-105f-4l/024ak1zf	реле
jqx-105f-4l/024ak1zt	реле
jqx-105f-4l/024ak1ztf	реле
jqx-105f-4l/048d1d	реле
jqx-105f-4l/048d1df	реле
jqx-105f-4l/048d1dt	реле
jqx-105f-4l/048d1dtf	реле
jqx-105f-4l/048d1h	реле
jqx-105f-4l/048d1hf	реле
jqx-105f-4l/048d1ht	реле

jqx-105f-4l/048d1htf	реле
jqx-105f-4l/048d1z	реле
jqx-105f-4l/048d1zf	реле
jqx-105f-4l/048d1zt	реле
jqx-105f-4l/048d1ztf	реле
jqx-105f-4l/048dk1d	реле
jqx-105f-4l/048dk1df	реле
jqx-105f-4l/048dk1dt	реле
jqx-105f-4l/048dk1dtf	реле
jqx-105f-4l/048dk1h	реле
jqx-105f-4l/048dk1hf	реле
jqx-105f-4l/048dk1ht	реле
jqx-105f-4l/048dk1htf	реле
jqx-105f-4l/048dk1z	реле
jqx-105f-4l/048dk1zf	реле
jqx-105f-4l/048dk1zt	реле
jqx-105f-4l/048dk1ztf	реле
jqx-105f-4l/070d1d	реле
jqx-105f-4l/070d1df	реле
jqx-105f-4l/070d1dt	реле
jqx-105f-4l/070d1dtf	реле
jqx-105f-4l/070d1h	реле
jqx-105f-4l/070d1hf	реле
jqx-105f-4l/070d1ht	реле
jqx-105f-4l/070d1htf	реле
jqx-105f-4l/070d1z	реле
jqx-105f-4l/070d1zf	реле
jqx-105f-4l/070d1zt	реле

jqx-105f-4l/070d1ztf реле
jqx-105f-4l/070dk1d реле
jqx-105f-4l/070dk1df реле
jqx-105f-4l/070dk1dt реле
jqx-105f-4l/070dk1dtf реле
jqx-105f-4l/070dk1h реле
jqx-105f-4l/070dk1hf реле
jqx-105f-4l/070dk1ht реле
jqx-105f-4l/070dk1htf реле
jqx-105f-4l/070dk1z реле
jqx-105f-4l/070dk1zf реле
jqx-105f-4l/070dk1zt реле
jqx-105f-4l/070dk1ztf реле
jqx-105f-4l/110d1d реле
jqx-105f-4l/110d1df реле
jqx-105f-4l/110d1dt реле
jqx-105f-4l/110d1dtf реле
jqx-105f-4l/110d1h реле
jqx-105f-4l/110d1hf реле
jqx-105f-4l/110d1ht реле
jqx-105f-4l/110d1htf реле
jqx-105f-4l/110d1z реле
jqx-105f-4l/110d1zf реле
jqx-105f-4l/110d1zt реле
jqx-105f-4l/110d1ztf реле
jqx-105f-4l/110dk1d реле
jqx-105f-4l/110dk1df реле
jqx-105f-4l/110dk1dt реле

jqx-105f-4l/110dk1dtf реле
jqx-105f-4l/110dk1h реле
jqx-105f-4l/110dk1hf реле
jqx-105f-4l/110dk1ht реле
jqx-105f-4l/110dk1htf реле
jqx-105f-4l/110dk1z реле
jqx-105f-4l/110dk1zf реле
jqx-105f-4l/110dk1zt реле
jqx-105f-4l/110dk1ztf реле
jqx-105f-4l/120a1d реле
jqx-105f-4l/120a1df реле
jqx-105f-4l/120a1dt реле
jqx-105f-4l/120a1dtf реле
jqx-105f-4l/120a1h реле
jqx-105f-4l/120a1hf реле
jqx-105f-4l/120a1ht реле
jqx-105f-4l/120a1htf реле
jqx-105f-4l/120a1z реле
jqx-105f-4l/120a1zf реле
jqx-105f-4l/120a1zt реле
jqx-105f-4l/120a1ztf реле
jqx-105f-4l/120ak1d реле
jqx-105f-4l/120ak1df реле
jqx-105f-4l/120ak1dt реле
jqx-105f-4l/120ak1dtf реле
jqx-105f-4l/120ak1h реле
jqx-105f-4l/120ak1hf реле
jqx-105f-4l/120ak1ht реле

jqx-105f-4l/120ak1htf реле
jqx-105f-4l/120ak1z реле
jqx-105f-4l/120ak1zf реле
jqx-105f-4l/120ak1zt реле
jqx-105f-4l/120ak1ztf реле
jqx-105f-4l/277a1d реле
jqx-105f-4l/277a1df реле
jqx-105f-4l/277a1dt реле
jqx-105f-4l/277a1dtf реле
jqx-105f-4l/277a1h реле
jqx-105f-4l/277a1hf реле
jqx-105f-4l/277a1ht реле
jqx-105f-4l/277a1htf реле
jqx-105f-4l/277a1z реле
jqx-105f-4l/277a1zf реле
jqx-105f-4l/277a1zt реле
jqx-105f-4l/277a1ztf реле
jqx-105f-4l/277ak1d реле
jqx-105f-4l/277ak1df реле
jqx-105f-4l/277ak1dt реле
jqx-105f-4l/277ak1dtf реле
jqx-105f-4l/277ak1h реле
jqx-105f-4l/277ak1hf реле
jqx-105f-4l/277ak1ht реле
jqx-105f-4l/277ak1htf реле
jqx-105f-4l/277ak1z реле
jqx-105f-4l/277ak1zf реле
jqx-105f-4l/277ak1zt реле

jqx-105f-4l/277ak1ztf реле
jqx-105f-4_04 реле
jqx-105f-5 etc1 [list of unclassified manufacturers], 30a 1 pole pc board type
jqx-105f-5l etc1 [list of unclassified manufacturers], 30a 1 pole pc board type
jqx-10ff реле
jqx-10ff/006a2zd реле
jqx-10ff/006a2znil реле
jqx-10ff/006a3z-1d реле
jqx-10ff/006a3z-1nil реле
jqx-10ff/006a3zd реле
jqx-10ff/006a3znil реле
jqx-10ff/006nil2zd реле
jqx-10ff/006nil2znil реле
jqx-10ff/006nil3z-1d реле
jqx-10ff/006nil3z-1nil реле
jqx-10ff/006nil3zd реле
jqx-10ff/006nil3znil реле
jqx-10ff/012a2zd реле
jqx-10ff/012a2znil реле
jqx-10ff/012a3z-1d реле
jqx-10ff/012a3z-1nil реле
jqx-10ff/012a3zd реле
jqx-10ff/012a3znil реле
jqx-10ff/012nil2zd реле
jqx-10ff/012nil2znil реле
jqx-10ff/012nil3z-1d реле
jqx-10ff/012nil3z-1nil реле
jqx-10ff/012nil3zd реле

jqx-10ff/012nil3znil	реле
jqx-10ff/024a2zd	реле
jqx-10ff/024a2znil	реле
jqx-10ff/024a3z-1d	реле
jqx-10ff/024a3z-1nil	реле
jqx-10ff/024a3zd	реле
jqx-10ff/024a3znil	реле
jqx-10ff/024nil2zd	реле
jqx-10ff/024nil2znil	реле
jqx-10ff/024nil3z-1d	реле
jqx-10ff/024nil3z-1nil	реле
jqx-10ff/024nil3zd	реле
jqx-10ff/024nil3znil	реле
jqx-10ff/048a2zd	реле
jqx-10ff/048a2znil	реле
jqx-10ff/048a3z-1d	реле
jqx-10ff/048a3z-1nil	реле
jqx-10ff/048a3zd	реле
jqx-10ff/048a3znil	реле
jqx-10ff/048nil2zd	реле
jqx-10ff/048nil2znil	реле
jqx-10ff/048nil3z-1d	реле
jqx-10ff/048nil3z-1nil	реле
jqx-10ff/048nil3zd	реле
jqx-10ff/048nil3znil	реле
jqx-10ff/100a2zd	реле
jqx-10ff/100a2znil	реле
jqx-10ff/100a3z-1d	реле

jqx-10ff/100a3z-1nil	реле
jqx-10ff/100a3zd	реле
jqx-10ff/100a3znil	реле
jqx-10ff/100nil2zd	реле
jqx-10ff/100nil2znil	реле
jqx-10ff/100nil3z-1d	реле
jqx-10ff/100nil3z-1nil	реле
jqx-10ff/100nil3zd	реле
jqx-10ff/100nil3znil	реле
jqx-10ff/110a2zd	реле
jqx-10ff/110a2znil	реле
jqx-10ff/110a3z-1d	реле
jqx-10ff/110a3z-1nil	реле
jqx-10ff/110a3zd	реле
jqx-10ff/110a3znil	реле
jqx-10ff/110nil2zd	реле
jqx-10ff/110nil2znil	реле
jqx-10ff/110nil3z-1d	реле
jqx-10ff/110nil3z-1nil	реле
jqx-10ff/110nil3zd	реле
jqx-10ff/110nil3znil	реле
jqx-10ff/120a2zd	реле
jqx-10ff/120a2znil	реле
jqx-10ff/120a3z-1d	реле
jqx-10ff/120a3z-1nil	реле
jqx-10ff/120a3zd	реле
jqx-10ff/120a3znil	реле
jqx-10ff/120nil2zd	реле

jqx-10ff/120nil2znil	реле
jqx-10ff/120nil3z-1d	реле
jqx-10ff/120nil3z-1nil	реле
jqx-10ff/120nil3zd	реле
jqx-10ff/120nil3znil	реле
jqx-10ff/220a2zd	реле
jqx-10ff/220a2znil	реле
jqx-10ff/220a3z-1d	реле
jqx-10ff/220a3z-1nil	реле
jqx-10ff/220a3zd	реле
jqx-10ff/220a3znil	реле
jqx-10ff/220nil2zd	реле
jqx-10ff/220nil2znil	реле
jqx-10ff/220nil3z-1d	реле
jqx-10ff/220nil3z-1nil	реле
jqx-10ff/220nil3zd	реле
jqx-10ff/220nil3znil	реле
jqx-10ff/240a2zd	реле
jqx-10ff/240a2znil	реле
jqx-10ff/240a3z-1d	реле
jqx-10ff/240a3z-1nil	реле
jqx-10ff/240a3zd	реле
jqx-10ff/240a3znil	реле
jqx-10ff/240nil2zd	реле
jqx-10ff/240nil2znil	реле
jqx-10ff/240nil3z-1d	реле
jqx-10ff/240nil3z-1nil	реле
jqx-10ff/240nil3zd	реле

jqx-10ff/240nil3znll реле

jqx-115 реле

jqx-115-f-i etc1 [list of unclassified manufacturers], 16a 1 pole pc board type

jqx-115f реле

jqx-115f-006-1hs3-551 glenair

jqx-115f-012-1hs3-551 glenair

jqx-115f-012-1hs3a(555) glenair

jqx-115f-012-1z1a 555 glenair

jqx-115f-012-1z3a 555 glenair

jqx-115f-012-1zs1 hongfa, dip 2011

jqx-115f-012-1zs3-551 glenair

jqx-115f-012-1zs3a (555) glenair

jqx-115f-012-1zs3b glenair

jqx-115f-012-2zs4 hongfa, dip 2011

jqx-115f-012-2zs4(551) hongfa electroacoustic co.,ltd., реле средней мощности; ик,а =8; ик,в =250вас; ии,в = 12; р,вт = 0.4; кол. ком. гр. =2; вид конт. группы с; ии/о,в =1000; тэкср, °с -40...+85; тип упр. и дс; вр. сраб. <15ms; тип монт. pcb; 29x12,7x15

jqx-115f-024-1z3 glenair

jqx-115f-024-1z3a-555 glenair

jqx-115f-024-1zs1 hongfa, dip 2011

jqx-115f-024-1zs3(551) hongfa electroacoustic co.,ltd., реле средней мощности; ик,а =16; ик,в =250вас; ии,в = 24; р,вт = 0.4; кол. ком. гр. = 1; вид конт. группы с; ии/о,в = 1000; тэкср, °с -40...+85; тип упр. и дс; вр. сраб. <15ms; тип монт. pcb; 29x12,7

jqx-115f-024-2zs4 glenair

jqx-115f-024-2zs4(551) hongfa electroacoustic co.,ltd., реле средней мощности; ик,а =8; ик,в =250вас; ии,в = 24; р,вт =0.4; кол. ком. гр. =2; вид конт. группы с; ии/о,в =1000; тэкср, °с -40...+85; тип упр. и дс; вр. сраб. <15ms; тип монт. pcb; 29x12,7x15,

jqx-115f-024-2zs4b glenair

jqx-115f-048-2zs4b-610-555 glenair

jqx-115f-i реле

jqx-115f-i0051hs3a реле

jqx-115f-i0061hs3a	реле
jqx-115f-i0091hs3a	реле
jqx-115f-i0121hs3a	реле
jqx-115f-i0181hs3a	реле
jqx-115f-i0241hs3a	реле
jqx-115f-i0481hs3a	реле
jqx-115f-i0601hs3a	реле
jqx-115f-i1101hnil3	etc1 [list of unclassified manufacturers], 16a 1 pole pc board type
jqx-115f-i1101hs3	etc1 [list of unclassified manufacturers], 16a 1 pole pc board type
jqx-115f-i1101hs3a	реле
jqx-115f-i121hnil3	etc1 [list of unclassified manufacturers], 16a 1 pole pc board type
jqx-115f-i121hs3	etc1 [list of unclassified manufacturers], 16a 1 pole pc board type
jqx-115f-i241hnil3	etc1 [list of unclassified manufacturers], 16a 1 pole pc board type
jqx-115f-i241hs3	etc1 [list of unclassified manufacturers], 16a 1 pole pc board type
jqx-115f-i481hnil3	etc1 [list of unclassified manufacturers], 16a 1 pole pc board type
jqx-115f-i481hs3	etc1 [list of unclassified manufacturers], 16a 1 pole pc board type
jqx-115f-i51hnil3	etc1 [list of unclassified manufacturers], 16a 1 pole pc board type
jqx-115f-i51hs3	etc1 [list of unclassified manufacturers], 16a 1 pole pc board type
jqx-115f-i601hnil3	etc1 [list of unclassified manufacturers], 16a 1 pole pc board type
jqx-115f-i601hs3	etc1 [list of unclassified manufacturers], 16a 1 pole pc board type
jqx-115f-i61hnil3	etc1 [list of unclassified manufacturers], 16a 1 pole pc board type
jqx-115f-i61hs3	etc1 [list of unclassified manufacturers], 16a 1 pole pc board type
jqx-115f-t	реле
jqx-115f-t-005-1z3-551	glenair
jqx-115f-t0051hnil3a	реле
jqx-115f-t0051hnil3b	реле
jqx-115f-t0051hnil3nil	реле
jqx-115f-t0051hs3a	реле

jqx-115f-t0051hs3b	реле
jqx-115f-t0051hs3nil	реле
jqx-115f-t0051znil3a	реле
jqx-115f-t0051znil3b	реле
jqx-115f-t0051znil3nil	реле
jqx-115f-t0051zs3a	реле
jqx-115f-t0051zs3b	реле
jqx-115f-t0051zs3nil	реле
jqx-115f-t0061hnil3a	реле
jqx-115f-t0061hnil3b	реле
jqx-115f-t0061hnil3nil	реле
jqx-115f-t0061hs3a	реле
jqx-115f-t0061hs3b	реле
jqx-115f-t0061hs3nil	реле
jqx-115f-t0061znil3a	реле
jqx-115f-t0061znil3b	реле
jqx-115f-t0061znil3nil	реле
jqx-115f-t0061zs3a	реле
jqx-115f-t0061zs3b	реле
jqx-115f-t0061zs3nil	реле
jqx-115f-t0091hnil3a	реле
jqx-115f-t0091hnil3b	реле
jqx-115f-t0091hnil3nil	реле
jqx-115f-t0091hs3a	реле
jqx-115f-t0091hs3b	реле
jqx-115f-t0091hs3nil	реле
jqx-115f-t0091znil3a	реле
jqx-115f-t0091znil3b	реле

jqx-115f-t0091znil3nil	реле
jqx-115f-t0091zs3a	реле
jqx-115f-t0091zs3b	реле
jqx-115f-t0091zs3nil	реле
jqx-115f-t0121hnil3a	реле
jqx-115f-t0121hnil3b	реле
jqx-115f-t0121hnil3nil	реле
jqx-115f-t0121hs3a	реле
jqx-115f-t0121hs3b	реле
jqx-115f-t0121hs3nil	реле
jqx-115f-t0121znil3a	реле
jqx-115f-t0121znil3b	реле
jqx-115f-t0121znil3nil	реле
jqx-115f-t0121zs3a	реле
jqx-115f-t0121zs3b	реле
jqx-115f-t0121zs3nil	реле
jqx-115f-t0181hnil3a	реле
jqx-115f-t0181hnil3b	реле
jqx-115f-t0181hnil3nil	реле
jqx-115f-t0181hs3a	реле
jqx-115f-t0181hs3b	реле
jqx-115f-t0181hs3nil	реле
jqx-115f-t0181znil3a	реле
jqx-115f-t0181znil3b	реле
jqx-115f-t0181znil3nil	реле
jqx-115f-t0181zs3a	реле
jqx-115f-t0181zs3b	реле
jqx-115f-t0181zs3nil	реле

jqx-115f-t0241hnil3a реле
jqx-115f-t0241hnil3b реле
jqx-115f-t0241hnil3nil реле
jqx-115f-t0241hs3a реле
jqx-115f-t0241hs3b реле
jqx-115f-t0241hs3nil реле
jqx-115f-t0241znil3a реле
jqx-115f-t0241znil3b реле
jqx-115f-t0241znil3nil реле
jqx-115f-t0241zs3a реле
jqx-115f-t0241zs3b реле
jqx-115f-t0241zs3nil реле
jqx-115f-t0481hnil3a реле
jqx-115f-t0481hnil3b реле
jqx-115f-t0481hnil3nil реле
jqx-115f-t0481hs3a реле
jqx-115f-t0481hs3b реле
jqx-115f-t0481hs3nil реле
jqx-115f-t0481znil3a реле
jqx-115f-t0481znil3b реле
jqx-115f-t0481znil3nil реле
jqx-115f-t0481zs3a реле
jqx-115f-t0481zs3b реле
jqx-115f-t0481zs3nil реле
jqx-115f-t0601hnil3a реле
jqx-115f-t0601hnil3b реле
jqx-115f-t0601hnil3nil реле
jqx-115f-t0601hs3a реле

jqx-115f-t0601hs3b реле
jqx-115f-t0601hs3nil реле
jqx-115f-t0601znil3a реле
jqx-115f-t0601znil3b реле
jqx-115f-t0601znil3nil реле
jqx-115f-t0601zs3a реле
jqx-115f-t0601zs3b реле
jqx-115f-t0601zs3nil реле
jqx-115f-th реле
jqx-115f-th0051hnil3a реле
jqx-115f-th0051hnil3b реле
jqx-115f-th0051hnil3nil реле
jqx-115f-th0051hs3a реле
jqx-115f-th0051hs3b реле
jqx-115f-th0051hs3nil реле
jqx-115f-th0051znil3a реле
jqx-115f-th0051znil3b реле
jqx-115f-th0051znil3nil реле
jqx-115f-th0051zs3a реле
jqx-115f-th0051zs3b реле
jqx-115f-th0051zs3nil реле
jqx-115f-th0061hnil3a реле
jqx-115f-th0061hnil3b реле
jqx-115f-th0061hnil3nil реле
jqx-115f-th0061hs3a реле
jqx-115f-th0061hs3b реле
jqx-115f-th0061hs3nil реле
jqx-115f-th0061znil3a реле

jqx-115f-th0061znil3b реле
jqx-115f-th0061znil3nil реле
jqx-115f-th0061zs3a реле
jqx-115f-th0061zs3b реле
jqx-115f-th0061zs3nil реле
jqx-115f-th0091hnil3a реле
jqx-115f-th0091hnil3b реле
jqx-115f-th0091hnil3nil реле
jqx-115f-th0091hs3a реле
jqx-115f-th0091hs3b реле
jqx-115f-th0091hs3nil реле
jqx-115f-th0091znil3a реле
jqx-115f-th0091znil3b реле
jqx-115f-th0091znil3nil реле
jqx-115f-th0091zs3a реле
jqx-115f-th0091zs3b реле
jqx-115f-th0091zs3nil реле
jqx-115f-th0121hnil3a реле
jqx-115f-th0121hnil3b реле
jqx-115f-th0121hnil3nil реле
jqx-115f-th0121hs3a реле
jqx-115f-th0121hs3b реле
jqx-115f-th0121hs3nil реле
jqx-115f-th0121znil3a реле
jqx-115f-th0121znil3b реле
jqx-115f-th0121znil3nil реле
jqx-115f-th0121zs3a реле
jqx-115f-th0121zs3b реле

jqx-115f-th0121zs3nil реле
jqx-115f-th0181hnil3a реле
jqx-115f-th0181hnil3b реле
jqx-115f-th0181hnil3nil реле
jqx-115f-th0181hs3a реле
jqx-115f-th0181hs3b реле
jqx-115f-th0181hs3nil реле
jqx-115f-th0181znil3a реле
jqx-115f-th0181znil3b реле
jqx-115f-th0181znil3nil реле
jqx-115f-th0181zs3a реле
jqx-115f-th0181zs3b реле
jqx-115f-th0181zs3nil реле
jqx-115f-th0241hnil3a реле
jqx-115f-th0241hnil3b реле
jqx-115f-th0241hnil3nil реле
jqx-115f-th0241hs3a реле
jqx-115f-th0241hs3b реле
jqx-115f-th0241hs3nil реле
jqx-115f-th0241znil3a реле
jqx-115f-th0241znil3b реле
jqx-115f-th0241znil3nil реле
jqx-115f-th0241zs3a реле
jqx-115f-th0241zs3b реле
jqx-115f-th0241zs3nil реле
jqx-115f-th0481hnil3a реле
jqx-115f-th0481hnil3b реле
jqx-115f-th0481hnil3nil реле

jqx-115f-th0481hs3a реле
jqx-115f-th0481hs3b реле
jqx-115f-th0481hs3nil реле
jqx-115f-th0481znil3a реле
jqx-115f-th0481znil3b реле
jqx-115f-th0481znil3nil реле
jqx-115f-th0481zs3a реле
jqx-115f-th0481zs3b реле
jqx-115f-th0481zs3nil реле
jqx-115f-th0601hnil3a реле
jqx-115f-th0601hnil3b реле
jqx-115f-th0601hnil3nil реле
jqx-115f-th0601hs3a реле
jqx-115f-th0601hs3b реле
jqx-115f-th0601hs3nil реле
jqx-115f-th0601znil3a реле
jqx-115f-th0601znil3b реле
jqx-115f-th0601znil3nil реле
jqx-115f-th0601zs3a реле
jqx-115f-th0601zs3b реле
jqx-115f-th0601zs3nil реле

jqx-115f/012-1zs3 (551) hongfa electroacoustic co.,ltd., реле средней мощности; $i_{к,а} = 16$; $u_{к,в} = 250$ vac; $i_{н,в} = 12$; $p_{вт} = 0.4$; кол. ком. гр. = 1; вид конт. группы с; $u_{i/o,в} = 1000$; тэкср, °с -40...+85; тип упр. и дс; вр. сраб. <15ms; тип монт. pcb; 29x12,

jqx-115f/0121ds1 реле
jqx-115f/0121ds2.3 реле
jqx-115f/0121ds4 реле
jqx-115f/0121hs1 реле
jqx-115f/0121hs2.3 реле

jqx-115f/0121hs4	реле
jqx-115f/0121zs1	реле
jqx-115f/0121zs2.3	реле
jqx-115f/0121zs4	реле
jqx-115f/0122ds1	реле
jqx-115f/0122ds2.3	реле
jqx-115f/0122ds4	реле
jqx-115f/0122hs1	реле
jqx-115f/0122hs2.3	реле
jqx-115f/0122hs4	реле
jqx-115f/0122zs1	реле
jqx-115f/0122zs2.3	реле
jqx-115f/0122zs4	реле
jqx-115f/1101ds1	реле
jqx-115f/1101ds2.3	реле
jqx-115f/1101ds4	реле
jqx-115f/1101hs1	реле
jqx-115f/1101hs2.3	реле
jqx-115f/1101hs4	реле
jqx-115f/1101zs1	реле
jqx-115f/1101zs2.3	реле
jqx-115f/1101zs4	реле
jqx-115f/1102ds1	реле
jqx-115f/1102ds2.3	реле
jqx-115f/1102ds4	реле
jqx-115f/1102hs1	реле
jqx-115f/1102hs2.3	реле
jqx-115f/1102hs4	реле

jqx-115f/1102zs1	реле
jqx-115f/1102zs2.3	реле
jqx-115f/1102zs4	реле
jqx-115f/121ds1	реле
jqx-115f/121ds2.3	реле
jqx-115f/121ds4	реле
jqx-115f/121hs1	реле
jqx-115f/121hs2.3	реле
jqx-115f/121hs4	реле
jqx-115f/121zs1	реле
jqx-115f/121zs2.3	реле
jqx-115f/121zs4	реле
jqx-115f/122ds1	реле
jqx-115f/122ds2.3	реле
jqx-115f/122ds4	реле
jqx-115f/122hs1	реле
jqx-115f/122hs2.3	реле
jqx-115f/122hs4	реле
jqx-115f/122zs1	реле
jqx-115f/122zs2.3	реле
jqx-115f/122zs4	реле
jqx-115f/241ds1	реле
jqx-115f/241ds2.3	реле
jqx-115f/241ds4	реле
jqx-115f/241hs1	реле
jqx-115f/241hs2.3	реле
jqx-115f/241hs4	реле
jqx-115f/241zs1	реле

jqx-115f/241zs2.3	реле
jqx-115f/241zs4	реле
jqx-115f/242ds1	реле
jqx-115f/242ds2.3	реле
jqx-115f/242ds4	реле
jqx-115f/242hs1	реле
jqx-115f/242hs2.3	реле
jqx-115f/242hs4	реле
jqx-115f/242zs1	реле
jqx-115f/242zs2.3	реле
jqx-115f/242zs4	реле
jqx-115f/481ds1	реле
jqx-115f/481ds2.3	реле
jqx-115f/481ds4	реле
jqx-115f/481hs1	реле
jqx-115f/481hs2.3	реле
jqx-115f/481hs4	реле
jqx-115f/481zs1	реле
jqx-115f/481zs2.3	реле
jqx-115f/481zs4	реле
jqx-115f/482ds1	реле
jqx-115f/482ds2.3	реле
jqx-115f/482ds4	реле
jqx-115f/482hs1	реле
jqx-115f/482hs2.3	реле
jqx-115f/482hs4	реле
jqx-115f/482zs1	реле
jqx-115f/482zs2.3	реле

jqx-115f/482zs4	реле
jqx-115f/51ds1	реле
jqx-115f/51ds2.3	реле
jqx-115f/51ds4	реле
jqx-115f/51hs1	реле
jqx-115f/51hs2.3	реле
jqx-115f/51hs4	реле
jqx-115f/51zs1	реле
jqx-115f/51zs2.3	реле
jqx-115f/51zs4	реле
jqx-115f/52ds1	реле
jqx-115f/52ds2.3	реле
jqx-115f/52ds4	реле
jqx-115f/52hs1	реле
jqx-115f/52hs2.3	реле
jqx-115f/52hs4	реле
jqx-115f/52zs1	реле
jqx-115f/52zs2.3	реле
jqx-115f/52zs4	реле
jqx-115f/601ds1	реле
jqx-115f/601ds2.3	реле
jqx-115f/601ds4	реле
jqx-115f/601hs1	реле
jqx-115f/601hs2.3	реле
jqx-115f/601hs4	реле
jqx-115f/601zs1	реле
jqx-115f/601zs2.3	реле
jqx-115f/601zs4	реле

jqx-115f/602ds1	реле
jqx-115f/602ds2.3	реле
jqx-115f/602ds4	реле
jqx-115f/602hs1	реле
jqx-115f/602hs2.3	реле
jqx-115f/602hs4	реле
jqx-115f/602zs1	реле
jqx-115f/602zs2.3	реле
jqx-115f/602zs4	реле
jqx-115f/61ds1	реле
jqx-115f/61ds2.3	реле
jqx-115f/61ds4	реле
jqx-115f/61hs1	реле
jqx-115f/61hs2.3	реле
jqx-115f/61hs4	реле
jqx-115f/61zs1	реле
jqx-115f/61zs2.3	реле
jqx-115f/61zs4	реле
jqx-115f/62ds1	реле
jqx-115f/62ds2.3	реле
jqx-115f/62ds4	реле
jqx-115f/62hs1	реле
jqx-115f/62hs2.3	реле
jqx-115f/62hs4	реле
jqx-115f/62zs1	реле
jqx-115f/62zs2.3	реле
jqx-115f/62zs4	реле
jqx-115f012-1zs2	

jqx-116f-1	реле
jqx-116f-1/асаа1h	реле
jqx-116f-1/асаа2h	реле
jqx-116f-1/асаf1h	реле
jqx-116f-1/асаf2h	реле
jqx-116f-1/асаp1h	реле
jqx-116f-1/асаp2h	реле
jqx-116f-1/асda1h	реле
jqx-116f-1/асda2h	реле
jqx-116f-1/асdf1h	реле
jqx-116f-1/асdf2h	реле
jqx-116f-1/асdp1h	реле
jqx-116f-1/асdp2h	реле
jqx-116f-1/dcaа1h	реле
jqx-116f-1/dcaа2h	реле
jqx-116f-1/dcaf1h	реле
jqx-116f-1/dcaf2h	реле
jqx-116f-1/dcap1h	реле
jqx-116f-1/dcap2h	реле
jqx-116f-1/dcda1h	реле
jqx-116f-1/dcda2h	реле
jqx-116f-1/dcdf1h	реле
jqx-116f-1/dcdf2h	реле
jqx-116f-1/dcdp1h	реле
jqx-116f-1/dcdp2h	реле
jqx-116f-2	реле
jqx-116f-2/018a1hniltfw	реле
jqx-116f-2/018a1hsnilfw	реле

jqx-116f-2/018a1hstfw	реле
jqx-116f-2/018a2hniltfw	реле
jqx-116f-2/018a2hsnilfw	реле
jqx-116f-2/018a2hstfw	реле
jqx-116f-2/018ap1hniltfw	реле
jqx-116f-2/018ap1hsnilfw	реле
jqx-116f-2/018ap1hstfw	реле
jqx-116f-2/018ap2hniltfw	реле
jqx-116f-2/018ap2hsnilfw	реле
jqx-116f-2/018ap2hstfw	реле
jqx-116f-2/018dl1hniltfw	реле
jqx-116f-2/018dl1hsnilfw	реле
jqx-116f-2/018dl1hstfw	реле
jqx-116f-2/018dl2hniltfw	реле
jqx-116f-2/018dl2hsnilfw	реле
jqx-116f-2/018dl2hstfw	реле
jqx-116f-2/018dp1hnilfw	реле
jqx-116f-2/018dp1hniltfw	реле
jqx-116f-2/018dp1hsnilfw	реле
jqx-116f-2/018dp1hstfw	реле
jqx-116f-2/018dp2hniltfw	реле
jqx-116f-2/018dp2hsnilfw	реле
jqx-116f-2/018dp2hstfw	реле
jqx-116f-3	реле
jqx-116f-3/003aa1hnilfw	реле
jqx-116f-3/003aa1hnilfw	реле
jqx-116f-3/003aa1htfw	реле
jqx-116f-3/003aa1htnilw	реле

jqx-116f-3/003aa2hnilfw	реле
jqx-116f-3/003aa2hnilnilw	реле
jqx-116f-3/003aa2htfw	реле
jqx-116f-3/003aa2htnilw	реле
jqx-116f-3/003af1hnilfw	реле
jqx-116f-3/003af1hnilnilw	реле
jqx-116f-3/003af1htfw	реле
jqx-116f-3/003af1htnilw	реле
jqx-116f-3/003af2hnilfw	реле
jqx-116f-3/003af2hnilnilw	реле
jqx-116f-3/003af2htfw	реле
jqx-116f-3/003af2htnilw	реле
jqx-116f-3/003da1hnilfw	реле
jqx-116f-3/003da1hnilnilw	реле
jqx-116f-3/003da1htfw	реле
jqx-116f-3/003da1htnilw	реле
jqx-116f-3/003da2hnilfw	реле
jqx-116f-3/003da2hnilnilw	реле
jqx-116f-3/003da2htfw	реле
jqx-116f-3/003da2htnilw	реле
jqx-116f-3/003df1hnilfw	реле
jqx-116f-3/003df1hnilnilw	реле
jqx-116f-3/003df1htfw	реле
jqx-116f-3/003df1htnilw	реле
jqx-116f-3/003df2hnilfw	реле
jqx-116f-3/003df2hnilnilw	реле
jqx-116f-3/003df2htfw	реле
jqx-116f-3/003df2htnilw	реле

jqx-116f-3/006aa1hnilfw	реле
jqx-116f-3/006aa1hnilnilw	реле
jqx-116f-3/006aa1htfw	реле
jqx-116f-3/006aa1htnilw	реле
jqx-116f-3/006aa2hnilfw	реле
jqx-116f-3/006aa2hnilnilw	реле
jqx-116f-3/006aa2htfw	реле
jqx-116f-3/006aa2htnilw	реле
jqx-116f-3/006af1hnilfw	реле
jqx-116f-3/006af1hnilnilw	реле
jqx-116f-3/006af1htfw	реле
jqx-116f-3/006af1htnilw	реле
jqx-116f-3/006af2hnilfw	реле
jqx-116f-3/006af2hnilnilw	реле
jqx-116f-3/006af2htfw	реле
jqx-116f-3/006af2htnilw	реле
jqx-116f-3/006da1hnilfw	реле
jqx-116f-3/006da1hnilnilw	реле
jqx-116f-3/006da1htfw	реле
jqx-116f-3/006da1htnilw	реле
jqx-116f-3/006da2hnilfw	реле
jqx-116f-3/006da2hnilnilw	реле
jqx-116f-3/006da2htfw	реле
jqx-116f-3/006da2htnilw	реле
jqx-116f-3/006df1hnilfw	реле
jqx-116f-3/006df1hnilnilw	реле
jqx-116f-3/006df1htfw	реле
jqx-116f-3/006df1htnilw	реле

jqx-116f-3/006df2hnilfw	реле
jqx-116f-3/006df2hnilnilw	реле
jqx-116f-3/006df2htfw	реле
jqx-116f-3/006df2htnilw	реле
jqx-116f-3/018aa1hnilfw	реле
jqx-116f-3/018aa1hnilnilw	реле
jqx-116f-3/018aa1htfw	реле
jqx-116f-3/018aa1htnilw	реле
jqx-116f-3/018aa2hnilfw	реле
jqx-116f-3/018aa2hnilnilw	реле
jqx-116f-3/018aa2htfw	реле
jqx-116f-3/018aa2htnilw	реле
jqx-116f-3/018af1hnilfw	реле
jqx-116f-3/018af1hnilnilw	реле
jqx-116f-3/018af1htfw	реле
jqx-116f-3/018af1htnilw	реле
jqx-116f-3/018af2hnilfw	реле
jqx-116f-3/018af2hnilnilw	реле
jqx-116f-3/018af2htfw	реле
jqx-116f-3/018af2htnilw	реле
jqx-116f-3/018da1hnilfw	реле
jqx-116f-3/018da1hnilnilw	реле
jqx-116f-3/018da1htfw	реле
jqx-116f-3/018da1htnilw	реле
jqx-116f-3/018da2hnilfw	реле
jqx-116f-3/018da2hnilnilw	реле
jqx-116f-3/018da2htfw	реле
jqx-116f-3/018da2htnilw	реле

jqx-116f-3/018df1hnilfw	реле
jqx-116f-3/018df1hnilnilw	реле
jqx-116f-3/018df1htfw	реле
jqx-116f-3/018df1htnilw	реле
jqx-116f-3/018df2hnilfw	реле
jqx-116f-3/018df2hnilnilw	реле
jqx-116f-3/018df2htfw	реле
jqx-116f-3/018df2htnilw	реле
jqx-116f-3/200aa1hnilfw	реле
jqx-116f-3/200aa1hnilnilw	реле
jqx-116f-3/200aa1htfw	реле
jqx-116f-3/200aa1htnilw	реле
jqx-116f-3/200aa2hnilfw	реле
jqx-116f-3/200aa2hnilnilw	реле
jqx-116f-3/200aa2htfw	реле
jqx-116f-3/200aa2htnilw	реле
jqx-116f-3/200af1hnilfw	реле
jqx-116f-3/200af1hnilnilw	реле
jqx-116f-3/200af1htfw	реле
jqx-116f-3/200af1htnilw	реле
jqx-116f-3/200af2hnilfw	реле
jqx-116f-3/200af2hnilnilw	реле
jqx-116f-3/200af2htfw	реле
jqx-116f-3/200af2htnilw	реле
jqx-116f-3/200da1hnilfw	реле
jqx-116f-3/200da1hnilnilw	реле
jqx-116f-3/200da1htfw	реле
jqx-116f-3/200da1htnilw	реле

jqx-116f-3/200da2hnilfw	реле
jqx-116f-3/200da2hnilnilw	реле
jqx-116f-3/200da2htfw	реле
jqx-116f-3/200da2htnilw	реле
jqx-116f-3/200df1hnilfw	реле
jqx-116f-3/200df1hnilnilw	реле
jqx-116f-3/200df1htfw	реле
jqx-116f-3/200df1htnilw	реле
jqx-116f-3/200df2hnilfw	реле
jqx-116f-3/200df2hnilnilw	реле
jqx-116f-3/200df2htfw	реле
jqx-116f-3/200df2htnilw	реле
jqx-116f-3/240aa1hnilfw	реле
jqx-116f-3/240aa1hnilnilw	реле
jqx-116f-3/240aa1htfw	реле
jqx-116f-3/240aa1htnilw	реле
jqx-116f-3/240aa2hnilfw	реле
jqx-116f-3/240aa2hnilnilw	реле
jqx-116f-3/240aa2htfw	реле
jqx-116f-3/240aa2htnilw	реле
jqx-116f-3/240af1hnilfw	реле
jqx-116f-3/240af1hnilnilw	реле
jqx-116f-3/240af1htfw	реле
jqx-116f-3/240af1htnilw	реле
jqx-116f-3/240af2hnilfw	реле
jqx-116f-3/240af2hnilnilw	реле
jqx-116f-3/240af2htfw	реле
jqx-116f-3/240af2htnilw	реле

jqx-116f-3/240da1hnilfw реле
jqx-116f-3/240da1hnilnilw реле
jqx-116f-3/240da1htfw реле
jqx-116f-3/240da1htnilw реле
jqx-116f-3/240da2hnilfw реле
jqx-116f-3/240da2hnilnilw реле
jqx-116f-3/240da2htfw реле
jqx-116f-3/240da2htnilw реле
jqx-116f-3/240df1hnilfw реле
jqx-116f-3/240df1hnilnilw реле
jqx-116f-3/240df1htfw реле
jqx-116f-3/240df1htnilw реле
jqx-116f-3/240df2hnilfw реле
jqx-116f-3/240df2hnilnilw реле
jqx-116f-3/240df2htfw реле
jqx-116f-3/240df2htnilw реле
jqx-118f-024-1zs1t-555 glenair
jqx-13f glenair, available
jqx-13f-24vac
jqx-13f-24vdc
jqx-13f/1202z1 etc2 [list of unclassified manufacturers], miniature intermediate power relay
jqx-13f/1202z1d etc2 [list of unclassified manufacturers], miniature intermediate power relay
jqx-13f/1202z2 etc2 [list of unclassified manufacturers], miniature intermediate power relay
jqx-13f/1202z2d etc2 [list of unclassified manufacturers], miniature intermediate power relay
jqx-13f/1202z3 etc2 [list of unclassified manufacturers], miniature intermediate power relay
jqx-13f/1202z3d etc2 [list of unclassified manufacturers], miniature intermediate power relay
jqx-13f/1202z4 etc2 [list of unclassified manufacturers], miniature intermediate power relay
jqx-13f/1202z4d etc2 [list of unclassified manufacturers], miniature intermediate power relay

jqx-13f/1202z5 etc2 [list of unclassified manufacturers], miniature intermediate power relay
jqx-13f/1202z5d etc2 [list of unclassified manufacturers], miniature intermediate power relay
jqx-13f/2201z1 etc2 [list of unclassified manufacturers], miniature intermediate power relay
jqx-13f/2201z1d etc2 [list of unclassified manufacturers], miniature intermediate power relay
jqx-13f/2201z2 etc2 [list of unclassified manufacturers], miniature intermediate power relay
jqx-13f/2201z2d etc2 [list of unclassified manufacturers], miniature intermediate power relay
jqx-13f/2201z3 etc2 [list of unclassified manufacturers], miniature intermediate power relay
jqx-13f/2201z3d etc2 [list of unclassified manufacturers], miniature intermediate power relay
jqx-13f/2201z4 etc2 [list of unclassified manufacturers], miniature intermediate power relay
jqx-13f/2201z4d etc2 [list of unclassified manufacturers], miniature intermediate power relay
jqx-13f/2201z5 etc2 [list of unclassified manufacturers], miniature intermediate power relay
jqx-13f/2201z5d etc2 [list of unclassified manufacturers], miniature intermediate power relay
jqx-13f/2202z1 etc2 [list of unclassified manufacturers], miniature intermediate power relay
jqx-13f/2202z1d etc2 [list of unclassified manufacturers], miniature intermediate power relay
jqx-13f/2202z2 etc2 [list of unclassified manufacturers], miniature intermediate power relay
jqx-13f/2202z2d etc2 [list of unclassified manufacturers], miniature intermediate power relay
jqx-13f/2202z3 etc2 [list of unclassified manufacturers], miniature intermediate power relay
jqx-13f/2202z3d etc2 [list of unclassified manufacturers], miniature intermediate power relay
jqx-13f/2202z4 etc2 [list of unclassified manufacturers], miniature intermediate power relay
jqx-13f/2202z4d etc2 [list of unclassified manufacturers], miniature intermediate power relay
jqx-13f/2202z5 etc2 [list of unclassified manufacturers], miniature intermediate power relay
jqx-13f/2202z5d etc2 [list of unclassified manufacturers], miniature intermediate power relay
jqx-13f/2402z1 etc2 [list of unclassified manufacturers], miniature intermediate power relay
jqx-13f/2402z1d etc2 [list of unclassified manufacturers], miniature intermediate power relay
jqx-13f/2402z2 etc2 [list of unclassified manufacturers], miniature intermediate power relay
jqx-13f/2402z2d etc2 [list of unclassified manufacturers], miniature intermediate power relay
jqx-13f/2402z3 etc2 [list of unclassified manufacturers], miniature intermediate power relay
jqx-13f/2402z3d etc2 [list of unclassified manufacturers], miniature intermediate power relay

jqx-13f/2402z4 etc2 [list of unclassified manufacturers], miniature intermediate power relay

jqx-13f/2402z4d etc2 [list of unclassified manufacturers], miniature intermediate power relay

jqx-13f/2402z5 etc2 [list of unclassified manufacturers], miniature intermediate power relay

jqx-13f/2402z5d etc2 [list of unclassified manufacturers], miniature intermediate power relay

jqx-13f/a0122z1d016 etc2 [list of unclassified manufacturers], miniature intermediate power relay

jqx-13f/a0281z1 etc2 [list of unclassified manufacturers], miniature intermediate power relay

jqx-13f/a0281z1d etc2 [list of unclassified manufacturers], miniature intermediate power relay

jqx-13f/a0281z2 etc2 [list of unclassified manufacturers], miniature intermediate power relay

jqx-13f/a0281z2d etc2 [list of unclassified manufacturers], miniature intermediate power relay

jqx-13f/a0281z3 etc2 [list of unclassified manufacturers], miniature intermediate power relay

jqx-13f/a0281z3d etc2 [list of unclassified manufacturers], miniature intermediate power relay

jqx-13f/a0281z4 etc2 [list of unclassified manufacturers], miniature intermediate power relay

jqx-13f/a0281z4d etc2 [list of unclassified manufacturers], miniature intermediate power relay

jqx-13f/a0281z5 etc2 [list of unclassified manufacturers], miniature intermediate power relay

jqx-13f/a0281z5d etc2 [list of unclassified manufacturers], miniature intermediate power relay

jqx-13f/a0282z1 etc2 [list of unclassified manufacturers], miniature intermediate power relay

jqx-13f/a0282z1d etc2 [list of unclassified manufacturers], miniature intermediate power relay

jqx-13f/a0282z2 etc2 [list of unclassified manufacturers], miniature intermediate power relay

jqx-13f/a0282z2d etc2 [list of unclassified manufacturers], miniature intermediate power relay

jqx-13f/a0282z3 etc2 [list of unclassified manufacturers], miniature intermediate power relay

jqx-13f/a0282z3d etc2 [list of unclassified manufacturers], miniature intermediate power relay

jqx-13f/a0282z4 etc2 [list of unclassified manufacturers], miniature intermediate power relay

jqx-13f/a0282z4d etc2 [list of unclassified manufacturers], miniature intermediate power relay

jqx-13f/a0282z5 etc2 [list of unclassified manufacturers], miniature intermediate power relay

jqx-13f/a0282z5d etc2 [list of unclassified manufacturers], miniature intermediate power relay

jqx-13f/a0301z1 etc2 [list of unclassified manufacturers], miniature intermediate power relay

jqx-13f/a0301z1d etc2 [list of unclassified manufacturers], miniature intermediate power relay

jqx-13f/a0301z2 etc2 [list of unclassified manufacturers], miniature intermediate power relay

jqx-13f/a0301z2d	etc2 [list of unclassified manufacturers], miniature intermediate power relay
jqx-13f/a0301z3	etc2 [list of unclassified manufacturers], miniature intermediate power relay
jqx-13f/a0301z3d	etc2 [list of unclassified manufacturers], miniature intermediate power relay
jqx-13f/a0301z4	etc2 [list of unclassified manufacturers], miniature intermediate power relay
jqx-13f/a0301z4d	etc2 [list of unclassified manufacturers], miniature intermediate power relay
jqx-13f/a0301z5	etc2 [list of unclassified manufacturers], miniature intermediate power relay
jqx-13f/a0301z5d	etc2 [list of unclassified manufacturers], miniature intermediate power relay
jqx-13f/a0302z1	etc2 [list of unclassified manufacturers], miniature intermediate power relay
jqx-13f/a0302z1d	etc2 [list of unclassified manufacturers], miniature intermediate power relay
jqx-13f/a0302z2	etc2 [list of unclassified manufacturers], miniature intermediate power relay
jqx-13f/a0302z2d	etc2 [list of unclassified manufacturers], miniature intermediate power relay
jqx-13f/a0302z3	etc2 [list of unclassified manufacturers], miniature intermediate power relay
jqx-13f/a0302z3d	etc2 [list of unclassified manufacturers], miniature intermediate power relay
jqx-13f/a0302z4	etc2 [list of unclassified manufacturers], miniature intermediate power relay
jqx-13f/a0302z4d	etc2 [list of unclassified manufacturers], miniature intermediate power relay
jqx-13f/a0302z5	etc2 [list of unclassified manufacturers], miniature intermediate power relay
jqx-13f/a0302z5d	etc2 [list of unclassified manufacturers], miniature intermediate power relay
jqx-13f1aaac110v1d	реле
jqx-13f1aaac110v1l	реле
jqx-13f1aaac110v1ld	реле
jqx-13f1aaac110v1nil	реле
jqx-13f1aaac110v2d	реле
jqx-13f1aaac110v2l	реле
jqx-13f1aaac110v2ld	реле
jqx-13f1aaac110v2nil	реле
jqx-13f1aaac12v1d	реле
jqx-13f1aaac12v1l	реле
jqx-13f1aaac12v1ld	реле

jqx-13f1aaac12v1nil	реле
jqx-13f1aaac12v2d	реле
jqx-13f1aaac12v2l	реле
jqx-13f1aaac12v2ld	реле
jqx-13f1aaac12v2nil	реле
jqx-13f1aaac24v1d	реле
jqx-13f1aaac24v1l	реле
jqx-13f1aaac24v1ld	реле
jqx-13f1aaac24v1nil	реле
jqx-13f1aaac24v2d	реле
jqx-13f1aaac24v2l	реле
jqx-13f1aaac24v2ld	реле
jqx-13f1aaac24v2nil	реле
jqx-13f1aaac36v1d	реле
jqx-13f1aaac36v1l	реле
jqx-13f1aaac36v1ld	реле
jqx-13f1aaac36v1nil	реле
jqx-13f1aaac36v2d	реле
jqx-13f1aaac36v2l	реле
jqx-13f1aaac36v2ld	реле
jqx-13f1aaac36v2nil	реле
jqx-13f1aaac48v1d	реле
jqx-13f1aaac48v1l	реле
jqx-13f1aaac48v1ld	реле
jqx-13f1aaac48v1nil	реле
jqx-13f1aaac48v2d	реле
jqx-13f1aaac48v2l	реле
jqx-13f1aaac48v2ld	реле

jqx-13f1aac48v2nil	реле
jqx-13f1aad110v1	ningbo forward relay corporation
jqx-13f1aad110v1d	реле
jqx-13f1aad110v1l	реле
jqx-13f1aad110v1d	реле
jqx-13f1aad110v1nil	реле
jqx-13f1aad110v2d	реле
jqx-13f1aad110v2l	реле
jqx-13f1aad110v2d	реле
jqx-13f1aad110v2nil	реле
jqx-13f1aad12v1d	реле
jqx-13f1aad12v1l	реле
jqx-13f1aad12v1d	реле
jqx-13f1aad12v1nil	реле
jqx-13f1aad12v2d	реле
jqx-13f1aad12v2l	реле
jqx-13f1aad12v2d	реле
jqx-13f1aad12v2nil	реле
jqx-13f1aad24v1d	реле
jqx-13f1aad24v1l	реле
jqx-13f1aad24v1d	реле
jqx-13f1aad24v1nil	реле
jqx-13f1aad24v2d	реле
jqx-13f1aad24v2l	реле
jqx-13f1aad24v2d	реле
jqx-13f1aad24v2nil	реле
jqx-13f1aad36v1d	реле
jqx-13f1aad36v1l	реле

jqx-13f1aacdc36v1d	реле
jqx-13f1aacdc36v1nil	реле
jqx-13f1aacdc36v2d	реле
jqx-13f1aacdc36v2l	реле
jqx-13f1aacdc36v2ld	реле
jqx-13f1aacdc36v2nil	реле
jqx-13f1aacdc48v1d	реле
jqx-13f1aacdc48v1l	реле
jqx-13f1aacdc48v1ld	реле
jqx-13f1aacdc48v1nil	реле
jqx-13f1aacdc48v2d	реле
jqx-13f1aacdc48v2l	реле
jqx-13f1aacdc48v2ld	реле
jqx-13f1aacdc48v2nil	реле
jqx-13f1abac110v1d	реле
jqx-13f1abac110v1l	реле
jqx-13f1abac110v1ld	реле
jqx-13f1abac110v1nil	реле
jqx-13f1abac110v2d	реле
jqx-13f1abac110v2l	реле
jqx-13f1abac110v2ld	реле
jqx-13f1abac110v2nil	реле
jqx-13f1abac12v1d	реле
jqx-13f1abac12v1l	реле
jqx-13f1abac12v1ld	реле
jqx-13f1abac12v1nil	реле
jqx-13f1abac12v2d	реле
jqx-13f1abac12v2l	реле

jqx-13f1abac12v2ld	реле
jqx-13f1abac12v2nil	реле
jqx-13f1abac24v1d	реле
jqx-13f1abac24v1l	реле
jqx-13f1abac24v1ld	реле
jqx-13f1abac24v1nil	реле
jqx-13f1abac24v2d	реле
jqx-13f1abac24v2l	реле
jqx-13f1abac24v2ld	реле
jqx-13f1abac24v2nil	реле
jqx-13f1abac36v1d	реле
jqx-13f1abac36v1l	реле
jqx-13f1abac36v1ld	реле
jqx-13f1abac36v1nil	реле
jqx-13f1abac36v2d	реле
jqx-13f1abac36v2l	реле
jqx-13f1abac36v2ld	реле
jqx-13f1abac36v2nil	реле
jqx-13f1abac48v1d	реле
jqx-13f1abac48v1l	реле
jqx-13f1abac48v1ld	реле
jqx-13f1abac48v1nil	реле
jqx-13f1abac48v2d	реле
jqx-13f1abac48v2l	реле
jqx-13f1abac48v2ld	реле
jqx-13f1abac48v2nil	реле
jqx-13f1abdc110v1d	реле
jqx-13f1abdc110v1l	реле

jqx-13f1abdc110v1ld	реле
jqx-13f1abdc110v1nil	реле
jqx-13f1abdc110v2d	реле
jqx-13f1abdc110v2l	реле
jqx-13f1abdc110v2ld	реле
jqx-13f1abdc110v2nil	реле
jqx-13f1abdc12v1d	реле
jqx-13f1abdc12v1l	реле
jqx-13f1abdc12v1ld	реле
jqx-13f1abdc12v1nil	реле
jqx-13f1abdc12v2d	реле
jqx-13f1abdc12v2l	реле
jqx-13f1abdc12v2ld	реле
jqx-13f1abdc12v2nil	реле
jqx-13f1abdc24v1d	реле
jqx-13f1abdc24v1l	реле
jqx-13f1abdc24v1ld	реле
jqx-13f1abdc24v1nil	реле
jqx-13f1abdc24v2d	реле
jqx-13f1abdc24v2l	реле
jqx-13f1abdc24v2ld	реле
jqx-13f1abdc24v2nil	реле
jqx-13f1abdc36v1d	реле
jqx-13f1abdc36v1l	реле
jqx-13f1abdc36v1ld	реле
jqx-13f1abdc36v1nil	реле
jqx-13f1abdc36v2d	реле
jqx-13f1abdc36v2l	реле

jqx-13f1abdc36v2ld	реле
jqx-13f1abdc36v2nil	реле
jqx-13f1abdc48v1d	реле
jqx-13f1abdc48v1l	реле
jqx-13f1abdc48v1ld	реле
jqx-13f1abdc48v1nil	реле
jqx-13f1abdc48v2d	реле
jqx-13f1abdc48v2l	реле
jqx-13f1abdc48v2ld	реле
jqx-13f1abdc48v2nil	реле
jqx-13f1baac110v1d	реле
jqx-13f1baac110v1l	реле
jqx-13f1baac110v1ld	реле
jqx-13f1baac110v1nil	реле
jqx-13f1baac110v2d	реле
jqx-13f1baac110v2l	реле
jqx-13f1baac110v2ld	реле
jqx-13f1baac110v2nil	реле
jqx-13f1baac12v1d	реле
jqx-13f1baac12v1l	реле
jqx-13f1baac12v1ld	реле
jqx-13f1baac12v1nil	реле
jqx-13f1baac12v2d	реле
jqx-13f1baac12v2l	реле
jqx-13f1baac12v2ld	реле
jqx-13f1baac12v2nil	реле
jqx-13f1baac24v1d	реле
jqx-13f1baac24v1l	реле

jqx-13f1baac24v1d	реле
jqx-13f1baac24v1nil	реле
jqx-13f1baac24v2d	реле
jqx-13f1baac24v2l	реле
jqx-13f1baac24v2ld	реле
jqx-13f1baac24v2nil	реле
jqx-13f1baac36v1d	реле
jqx-13f1baac36v1l	реле
jqx-13f1baac36v1ld	реле
jqx-13f1baac36v1nil	реле
jqx-13f1baac36v2d	реле
jqx-13f1baac36v2l	реле
jqx-13f1baac36v2ld	реле
jqx-13f1baac36v2nil	реле
jqx-13f1baac48v1d	реле
jqx-13f1baac48v1l	реле
jqx-13f1baac48v1ld	реле
jqx-13f1baac48v1nil	реле
jqx-13f1baac48v2d	реле
jqx-13f1baac48v2l	реле
jqx-13f1baac48v2ld	реле
jqx-13f1baac48v2nil	реле
jqx-13f1badc110v1d	реле
jqx-13f1badc110v1l	реле
jqx-13f1badc110v1ld	реле
jqx-13f1badc110v1nil	реле
jqx-13f1badc110v2d	реле
jqx-13f1badc110v2l	реле

jqx-13f1badc110v2ld	реле
jqx-13f1badc110v2nil	реле
jqx-13f1badc12v1d	реле
jqx-13f1badc12v1l	реле
jqx-13f1badc12v1ld	реле
jqx-13f1badc12v1nil	реле
jqx-13f1badc12v2d	реле
jqx-13f1badc12v2l	реле
jqx-13f1badc12v2ld	реле
jqx-13f1badc12v2nil	реле
jqx-13f1badc24v1d	реле
jqx-13f1badc24v1l	реле
jqx-13f1badc24v1ld	реле
jqx-13f1badc24v1nil	реле
jqx-13f1badc24v2d	реле
jqx-13f1badc24v2l	реле
jqx-13f1badc24v2ld	реле
jqx-13f1badc24v2nil	реле
jqx-13f1badc36v1d	реле
jqx-13f1badc36v1l	реле
jqx-13f1badc36v1ld	реле
jqx-13f1badc36v1nil	реле
jqx-13f1badc36v2d	реле
jqx-13f1badc36v2l	реле
jqx-13f1badc36v2ld	реле
jqx-13f1badc36v2nil	реле
jqx-13f1badc48v1d	реле
jqx-13f1badc48v1l	реле

jqx-13f1badc48v1d	реле
jqx-13f1badc48v1nil	реле
jqx-13f1badc48v2d	реле
jqx-13f1badc48v2l	реле
jqx-13f1badc48v2ld	реле
jqx-13f1badc48v2nil	реле
jqx-13f1bbac110v1d	реле
jqx-13f1bbac110v1l	реле
jqx-13f1bbac110v1ld	реле
jqx-13f1bbac110v1nil	реле
jqx-13f1bbac110v2d	реле
jqx-13f1bbac110v2l	реле
jqx-13f1bbac110v2ld	реле
jqx-13f1bbac110v2nil	реле
jqx-13f1bbac12v1d	реле
jqx-13f1bbac12v1l	реле
jqx-13f1bbac12v1ld	реле
jqx-13f1bbac12v1nil	реле
jqx-13f1bbac12v2d	реле
jqx-13f1bbac12v2l	реле
jqx-13f1bbac12v2ld	реле
jqx-13f1bbac12v2nil	реле
jqx-13f1bbac24v1d	реле
jqx-13f1bbac24v1l	реле
jqx-13f1bbac24v1ld	реле
jqx-13f1bbac24v1nil	реле
jqx-13f1bbac24v2d	реле
jqx-13f1bbac24v2l	реле

jqx-13f1bbac24v2ld	реле
jqx-13f1bbac24v2nil	реле
jqx-13f1bbac36v1d	реле
jqx-13f1bbac36v1l	реле
jqx-13f1bbac36v1ld	реле
jqx-13f1bbac36v1nil	реле
jqx-13f1bbac36v2d	реле
jqx-13f1bbac36v2l	реле
jqx-13f1bbac36v2ld	реле
jqx-13f1bbac36v2nil	реле
jqx-13f1bbac48v1d	реле
jqx-13f1bbac48v1l	реле
jqx-13f1bbac48v1ld	реле
jqx-13f1bbac48v1nil	реле
jqx-13f1bbac48v2d	реле
jqx-13f1bbac48v2l	реле
jqx-13f1bbac48v2ld	реле
jqx-13f1bbac48v2nil	реле
jqx-13f1bbdc110v1d	реле
jqx-13f1bbdc110v1l	реле
jqx-13f1bbdc110v1ld	реле
jqx-13f1bbdc110v1nil	реле
jqx-13f1bbdc110v2d	реле
jqx-13f1bbdc110v2l	реле
jqx-13f1bbdc110v2ld	реле
jqx-13f1bbdc110v2nil	реле
jqx-13f1bbdc12v1d	реле
jqx-13f1bbdc12v1l	реле

jqx-13f1bbdc12v1d	реле
jqx-13f1bbdc12v1nil	реле
jqx-13f1bbdc12v2d	реле
jqx-13f1bbdc12v2l	реле
jqx-13f1bbdc12v2d	реле
jqx-13f1bbdc12v2nil	реле
jqx-13f1bbdc24v1d	реле
jqx-13f1bbdc24v1l	реле
jqx-13f1bbdc24v1d	реле
jqx-13f1bbdc24v1nil	реле
jqx-13f1bbdc24v2d	реле
jqx-13f1bbdc24v2l	реле
jqx-13f1bbdc24v2d	реле
jqx-13f1bbdc24v2nil	реле
jqx-13f1bbdc36v1d	реле
jqx-13f1bbdc36v1l	реле
jqx-13f1bbdc36v1d	реле
jqx-13f1bbdc36v1nil	реле
jqx-13f1bbdc36v2d	реле
jqx-13f1bbdc36v2l	реле
jqx-13f1bbdc36v2d	реле
jqx-13f1bbdc36v2nil	реле
jqx-13f1bbdc48v1d	реле
jqx-13f1bbdc48v1l	реле
jqx-13f1bbdc48v1d	реле
jqx-13f1bbdc48v1nil	реле
jqx-13f1bbdc48v2d	реле
jqx-13f1bbdc48v2l	реле

jqx-13f1bbdc48v2ld	реле
jqx-13f1bbdc48v2nil	реле
jqx-13f1caac110v1d	реле
jqx-13f1caac110v1l	реле
jqx-13f1caac110v1ld	реле
jqx-13f1caac110v1nil	реле
jqx-13f1caac110v2d	реле
jqx-13f1caac110v2l	реле
jqx-13f1caac110v2ld	реле
jqx-13f1caac110v2nil	реле
jqx-13f1caac12v1d	реле
jqx-13f1caac12v1l	реле
jqx-13f1caac12v1ld	реле
jqx-13f1caac12v1nil	реле
jqx-13f1caac12v2d	реле
jqx-13f1caac12v2l	реле
jqx-13f1caac12v2ld	реле
jqx-13f1caac12v2nil	реле
jqx-13f1caac24v1d	реле
jqx-13f1caac24v1l	реле
jqx-13f1caac24v1ld	реле
jqx-13f1caac24v1nil	реле
jqx-13f1caac24v2d	реле
jqx-13f1caac24v2l	реле
jqx-13f1caac24v2ld	реле
jqx-13f1caac24v2nil	реле
jqx-13f1caac36v1d	реле
jqx-13f1caac36v1l	реле

jqx-13f1caac36v1d	реле
jqx-13f1caac36v1nil	реле
jqx-13f1caac36v2d	реле
jqx-13f1caac36v2l	реле
jqx-13f1caac36v2ld	реле
jqx-13f1caac36v2nil	реле
jqx-13f1caac48v1d	реле
jqx-13f1caac48v1l	реле
jqx-13f1caac48v1ld	реле
jqx-13f1caac48v1nil	реле
jqx-13f1caac48v2d	реле
jqx-13f1caac48v2l	реле
jqx-13f1caac48v2ld	реле
jqx-13f1caac48v2nil	реле
jqx-13f1cadc110v1d	реле
jqx-13f1cadc110v1l	реле
jqx-13f1cadc110v1ld	реле
jqx-13f1cadc110v1nil	реле
jqx-13f1cadc110v2d	реле
jqx-13f1cadc110v2l	реле
jqx-13f1cadc110v2ld	реле
jqx-13f1cadc110v2nil	реле
jqx-13f1cadc12v1d	реле
jqx-13f1cadc12v1l	реле
jqx-13f1cadc12v1ld	реле
jqx-13f1cadc12v1nil	реле
jqx-13f1cadc12v2d	реле
jqx-13f1cadc12v2l	реле

jqx-13f1cadc12v2ld	реле
jqx-13f1cadc12v2nil	реле
jqx-13f1cadc24v1d	реле
jqx-13f1cadc24v1l	реле
jqx-13f1cadc24v1ld	реле
jqx-13f1cadc24v1nil	реле
jqx-13f1cadc24v2d	реле
jqx-13f1cadc24v2l	реле
jqx-13f1cadc24v2ld	реле
jqx-13f1cadc24v2nil	реле
jqx-13f1cadc36v1d	реле
jqx-13f1cadc36v1l	реле
jqx-13f1cadc36v1ld	реле
jqx-13f1cadc36v1nil	реле
jqx-13f1cadc36v2d	реле
jqx-13f1cadc36v2l	реле
jqx-13f1cadc36v2ld	реле
jqx-13f1cadc36v2nil	реле
jqx-13f1cadc48v1d	реле
jqx-13f1cadc48v1l	реле
jqx-13f1cadc48v1ld	реле
jqx-13f1cadc48v1nil	реле
jqx-13f1cadc48v2d	реле
jqx-13f1cadc48v2l	реле
jqx-13f1cadc48v2ld	реле
jqx-13f1cadc48v2nil	реле
jqx-13f1cbac110v1d	реле
jqx-13f1cbac110v1l	реле

jqx-13f1cbac110v1ld	реле
jqx-13f1cbac110v1nil	реле
jqx-13f1cbac110v2d	реле
jqx-13f1cbac110v2l	реле
jqx-13f1cbac110v2ld	реле
jqx-13f1cbac110v2nil	реле
jqx-13f1cbac12v1d	реле
jqx-13f1cbac12v1l	реле
jqx-13f1cbac12v1ld	реле
jqx-13f1cbac12v1nil	реле
jqx-13f1cbac12v2d	реле
jqx-13f1cbac12v2l	реле
jqx-13f1cbac12v2ld	реле
jqx-13f1cbac12v2nil	реле
jqx-13f1cbac24v1d	реле
jqx-13f1cbac24v1l	реле
jqx-13f1cbac24v1ld	реле
jqx-13f1cbac24v1nil	реле
jqx-13f1cbac24v2d	реле
jqx-13f1cbac24v2l	реле
jqx-13f1cbac24v2ld	реле
jqx-13f1cbac24v2nil	реле
jqx-13f1cbac36v1d	реле
jqx-13f1cbac36v1l	реле
jqx-13f1cbac36v1ld	реле
jqx-13f1cbac36v1nil	реле
jqx-13f1cbac36v2d	реле
jqx-13f1cbac36v2l	реле

jqx-13f1cbac36v2ld	реле
jqx-13f1cbac36v2nil	реле
jqx-13f1cbac48v1d	реле
jqx-13f1cbac48v1l	реле
jqx-13f1cbac48v1ld	реле
jqx-13f1cbac48v1nil	реле
jqx-13f1cbac48v2d	реле
jqx-13f1cbac48v2l	реле
jqx-13f1cbac48v2ld	реле
jqx-13f1cbac48v2nil	реле
jqx-13f1cbdc110v1d	реле
jqx-13f1cbdc110v1l	реле
jqx-13f1cbdc110v1ld	реле
jqx-13f1cbdc110v1nil	реле
jqx-13f1cbdc110v2d	реле
jqx-13f1cbdc110v2l	реле
jqx-13f1cbdc110v2ld	реле
jqx-13f1cbdc110v2nil	реле
jqx-13f1cbdc12v1d	реле
jqx-13f1cbdc12v1l	реле
jqx-13f1cbdc12v1ld	реле
jqx-13f1cbdc12v1nil	реле
jqx-13f1cbdc12v2d	реле
jqx-13f1cbdc12v2l	реле
jqx-13f1cbdc12v2ld	реле
jqx-13f1cbdc12v2nil	реле
jqx-13f1cbdc24v1d	реле
jqx-13f1cbdc24v1l	реле

jqx-13f1cbdc24v1d	реле
jqx-13f1cbdc24v1nil	реле
jqx-13f1cbdc24v2d	реле
jqx-13f1cbdc24v2l	реле
jqx-13f1cbdc24v2ld	реле
jqx-13f1cbdc24v2nil	реле
jqx-13f1cbdc36v1d	реле
jqx-13f1cbdc36v1l	реле
jqx-13f1cbdc36v1ld	реле
jqx-13f1cbdc36v1nil	реле
jqx-13f1cbdc36v2d	реле
jqx-13f1cbdc36v2l	реле
jqx-13f1cbdc36v2ld	реле
jqx-13f1cbdc36v2nil	реле
jqx-13f1cbdc48v1d	реле
jqx-13f1cbdc48v1l	реле
jqx-13f1cbdc48v1ld	реле
jqx-13f1cbdc48v1nil	реле
jqx-13f1cbdc48v2d	реле
jqx-13f1cbdc48v2l	реле
jqx-13f1cbdc48v2ld	реле
jqx-13f1cbdc48v2nil	реле
jqx-13f2aaac110v1d	реле
jqx-13f2aaac110v1l	реле
jqx-13f2aaac110v1ld	реле
jqx-13f2aaac110v1nil	реле
jqx-13f2aaac110v2d	реле
jqx-13f2aaac110v2l	реле

jqx-13f2aaac110v2ld	реле
jqx-13f2aaac110v2nil	реле
jqx-13f2aaac12v1d	реле
jqx-13f2aaac12v1l	реле
jqx-13f2aaac12v1ld	реле
jqx-13f2aaac12v1nil	реле
jqx-13f2aaac12v2d	реле
jqx-13f2aaac12v2l	реле
jqx-13f2aaac12v2ld	реле
jqx-13f2aaac12v2nil	реле
jqx-13f2aaac24v1d	реле
jqx-13f2aaac24v1l	реле
jqx-13f2aaac24v1ld	реле
jqx-13f2aaac24v1nil	реле
jqx-13f2aaac24v2d	реле
jqx-13f2aaac24v2l	реле
jqx-13f2aaac24v2ld	реле
jqx-13f2aaac24v2nil	реле
jqx-13f2aaac36v1d	реле
jqx-13f2aaac36v1l	реле
jqx-13f2aaac36v1ld	реле
jqx-13f2aaac36v1nil	реле
jqx-13f2aaac36v2d	реле
jqx-13f2aaac36v2l	реле
jqx-13f2aaac36v2ld	реле
jqx-13f2aaac36v2nil	реле
jqx-13f2aaac48v1d	реле
jqx-13f2aaac48v1l	реле

jqx-13f2aaac48v1d	реле
jqx-13f2aaac48v1nil	реле
jqx-13f2aaac48v2d	реле
jqx-13f2aaac48v2l	реле
jqx-13f2aaac48v2ld	реле
jqx-13f2aaac48v2nil	реле
jqx-13f2aac110v1d	реле
jqx-13f2aac110v1l	реле
jqx-13f2aac110v1ld	реле
jqx-13f2aac110v1nil	реле
jqx-13f2aac110v2d	реле
jqx-13f2aac110v2l	реле
jqx-13f2aac110v2ld	реле
jqx-13f2aac110v2nil	реле
jqx-13f2aac12v1d	реле
jqx-13f2aac12v1l	реле
jqx-13f2aac12v1ld	реле
jqx-13f2aac12v1nil	реле
jqx-13f2aac12v2d	реле
jqx-13f2aac12v2l	реле
jqx-13f2aac12v2ld	реле
jqx-13f2aac12v2nil	реле
jqx-13f2aac24v1d	реле
jqx-13f2aac24v1l	реле
jqx-13f2aac24v1ld	реле
jqx-13f2aac24v1nil	реле
jqx-13f2aac24v2d	реле
jqx-13f2aac24v2l	реле

jqx-13f2aacdc24v2ld	реле
jqx-13f2aacdc24v2nil	реле
jqx-13f2aacdc36v1d	реле
jqx-13f2aacdc36v1l	реле
jqx-13f2aacdc36v1ld	реле
jqx-13f2aacdc36v1nil	реле
jqx-13f2aacdc36v2d	реле
jqx-13f2aacdc36v2l	реле
jqx-13f2aacdc36v2ld	реле
jqx-13f2aacdc36v2nil	реле
jqx-13f2aacdc48v1d	реле
jqx-13f2aacdc48v1l	реле
jqx-13f2aacdc48v1ld	реле
jqx-13f2aacdc48v1nil	реле
jqx-13f2aacdc48v2d	реле
jqx-13f2aacdc48v2l	реле
jqx-13f2aacdc48v2ld	реле
jqx-13f2aacdc48v2nil	реле
jqx-13f2abac110v1d	реле
jqx-13f2abac110v1l	реле
jqx-13f2abac110v1ld	реле
jqx-13f2abac110v1nil	реле
jqx-13f2abac110v2d	реле
jqx-13f2abac110v2l	реле
jqx-13f2abac110v2ld	реле
jqx-13f2abac110v2nil	реле
jqx-13f2abac12v1d	реле
jqx-13f2abac12v1l	реле

jqx-13f2abac12v1d	реле
jqx-13f2abac12v1nil	реле
jqx-13f2abac12v2d	реле
jqx-13f2abac12v2l	реле
jqx-13f2abac12v2ld	реле
jqx-13f2abac12v2nil	реле
jqx-13f2abac24v1d	реле
jqx-13f2abac24v1l	реле
jqx-13f2abac24v1ld	реле
jqx-13f2abac24v1nil	реле
jqx-13f2abac24v2d	реле
jqx-13f2abac24v2l	реле
jqx-13f2abac24v2ld	реле
jqx-13f2abac24v2nil	реле
jqx-13f2abac36v1d	реле
jqx-13f2abac36v1l	реле
jqx-13f2abac36v1ld	реле
jqx-13f2abac36v1nil	реле
jqx-13f2abac36v2d	реле
jqx-13f2abac36v2l	реле
jqx-13f2abac36v2ld	реле
jqx-13f2abac36v2nil	реле
jqx-13f2abac48v1d	реле
jqx-13f2abac48v1l	реле
jqx-13f2abac48v1ld	реле
jqx-13f2abac48v1nil	реле
jqx-13f2abac48v2d	реле
jqx-13f2abac48v2l	реле

jqx-13f2abac48v2ld	реле
jqx-13f2abac48v2nil	реле
jqx-13f2abdc110v1d	реле
jqx-13f2abdc110v1l	реле
jqx-13f2abdc110v1ld	реле
jqx-13f2abdc110v1nil	реле
jqx-13f2abdc110v2d	реле
jqx-13f2abdc110v2l	реле
jqx-13f2abdc110v2ld	реле
jqx-13f2abdc110v2nil	реле
jqx-13f2abdc12v1d	реле
jqx-13f2abdc12v1l	реле
jqx-13f2abdc12v1ld	реле
jqx-13f2abdc12v1nil	реле
jqx-13f2abdc12v2d	реле
jqx-13f2abdc12v2l	реле
jqx-13f2abdc12v2ld	реле
jqx-13f2abdc12v2nil	реле
jqx-13f2abdc24v1d	реле
jqx-13f2abdc24v1l	реле
jqx-13f2abdc24v1ld	реле
jqx-13f2abdc24v1nil	реле
jqx-13f2abdc24v2d	реле
jqx-13f2abdc24v2l	реле
jqx-13f2abdc24v2ld	реле
jqx-13f2abdc24v2nil	реле
jqx-13f2abdc36v1d	реле
jqx-13f2abdc36v1l	реле

jqx-13f2abdc36v1d	реле
jqx-13f2abdc36v1nil	реле
jqx-13f2abdc36v2d	реле
jqx-13f2abdc36v2l	реле
jqx-13f2abdc36v2ld	реле
jqx-13f2abdc36v2nil	реле
jqx-13f2abdc48v1d	реле
jqx-13f2abdc48v1l	реле
jqx-13f2abdc48v1ld	реле
jqx-13f2abdc48v1nil	реле
jqx-13f2abdc48v2d	реле
jqx-13f2abdc48v2l	реле
jqx-13f2abdc48v2ld	реле
jqx-13f2abdc48v2nil	реле
jqx-13f2baac110v1d	реле
jqx-13f2baac110v1l	реле
jqx-13f2baac110v1ld	реле
jqx-13f2baac110v1nil	реле
jqx-13f2baac110v2d	реле
jqx-13f2baac110v2l	реле
jqx-13f2baac110v2ld	реле
jqx-13f2baac110v2nil	реле
jqx-13f2baac12v1d	реле
jqx-13f2baac12v1l	реле
jqx-13f2baac12v1ld	реле
jqx-13f2baac12v1nil	реле
jqx-13f2baac12v2d	реле
jqx-13f2baac12v2l	реле

jqx-13f2baac12v2ld	реле
jqx-13f2baac12v2nil	реле
jqx-13f2baac24v1d	реле
jqx-13f2baac24v1l	реле
jqx-13f2baac24v1ld	реле
jqx-13f2baac24v1nil	реле
jqx-13f2baac24v2d	реле
jqx-13f2baac24v2l	реле
jqx-13f2baac24v2ld	реле
jqx-13f2baac24v2nil	реле
jqx-13f2baac36v1d	реле
jqx-13f2baac36v1l	реле
jqx-13f2baac36v1ld	реле
jqx-13f2baac36v1nil	реле
jqx-13f2baac36v2d	реле
jqx-13f2baac36v2l	реле
jqx-13f2baac36v2ld	реле
jqx-13f2baac36v2nil	реле
jqx-13f2baac48v1d	реле
jqx-13f2baac48v1l	реле
jqx-13f2baac48v1ld	реле
jqx-13f2baac48v1nil	реле
jqx-13f2baac48v2d	реле
jqx-13f2baac48v2l	реле
jqx-13f2baac48v2ld	реле
jqx-13f2baac48v2nil	реле
jqx-13f2badc110v1d	реле
jqx-13f2badc110v1l	реле

jqx-13f2badc110v1d	реле
jqx-13f2badc110v1nil	реле
jqx-13f2badc110v2d	реле
jqx-13f2badc110v2l	реле
jqx-13f2badc110v2ld	реле
jqx-13f2badc110v2nil	реле
jqx-13f2badc12v1d	реле
jqx-13f2badc12v1l	реле
jqx-13f2badc12v1ld	реле
jqx-13f2badc12v1nil	реле
jqx-13f2badc12v2d	реле
jqx-13f2badc12v2l	реле
jqx-13f2badc12v2ld	реле
jqx-13f2badc12v2nil	реле
jqx-13f2badc24v1d	реле
jqx-13f2badc24v1l	реле
jqx-13f2badc24v1ld	реле
jqx-13f2badc24v1nil	реле
jqx-13f2badc24v2d	реле
jqx-13f2badc24v2l	реле
jqx-13f2badc24v2ld	реле
jqx-13f2badc24v2nil	реле
jqx-13f2badc36v1d	реле
jqx-13f2badc36v1l	реле
jqx-13f2badc36v1ld	реле
jqx-13f2badc36v1nil	реле
jqx-13f2badc36v2d	реле
jqx-13f2badc36v2l	реле

jqx-13f2badc36v2d	реле
jqx-13f2badc36v2nil	реле
jqx-13f2badc48v1d	реле
jqx-13f2badc48v1l	реле
jqx-13f2badc48v1d	реле
jqx-13f2badc48v1nil	реле
jqx-13f2badc48v2d	реле
jqx-13f2badc48v2l	реле
jqx-13f2badc48v2d	реле
jqx-13f2badc48v2nil	реле
jqx-13f2bbac110v1d	реле
jqx-13f2bbac110v1l	реле
jqx-13f2bbac110v1d	реле
jqx-13f2bbac110v1nil	реле
jqx-13f2bbac110v2d	реле
jqx-13f2bbac110v2l	реле
jqx-13f2bbac110v2d	реле
jqx-13f2bbac110v2nil	реле
jqx-13f2bbac12v1d	реле
jqx-13f2bbac12v1l	реле
jqx-13f2bbac12v1d	реле
jqx-13f2bbac12v1nil	реле
jqx-13f2bbac12v2d	реле
jqx-13f2bbac12v2l	реле
jqx-13f2bbac12v2d	реле
jqx-13f2bbac12v2nil	реле
jqx-13f2bbac24v1d	реле
jqx-13f2bbac24v1l	реле

jqx-13f2bbac24v1d	реле
jqx-13f2bbac24v1nil	реле
jqx-13f2bbac24v2d	реле
jqx-13f2bbac24v2l	реле
jqx-13f2bbac24v2ld	реле
jqx-13f2bbac24v2nil	реле
jqx-13f2bbac36v1d	реле
jqx-13f2bbac36v1l	реле
jqx-13f2bbac36v1ld	реле
jqx-13f2bbac36v1nil	реле
jqx-13f2bbac36v2d	реле
jqx-13f2bbac36v2l	реле
jqx-13f2bbac36v2ld	реле
jqx-13f2bbac36v2nil	реле
jqx-13f2bbac48v1d	реле
jqx-13f2bbac48v1l	реле
jqx-13f2bbac48v1ld	реле
jqx-13f2bbac48v1nil	реле
jqx-13f2bbac48v2d	реле
jqx-13f2bbac48v2l	реле
jqx-13f2bbac48v2ld	реле
jqx-13f2bbac48v2nil	реле
jqx-13f2bbdc110v1d	реле
jqx-13f2bbdc110v1l	реле
jqx-13f2bbdc110v1ld	реле
jqx-13f2bbdc110v1nil	реле
jqx-13f2bbdc110v2d	реле
jqx-13f2bbdc110v2l	реле

jqx-13f2bbdc110v2ld	реле
jqx-13f2bbdc110v2nil	реле
jqx-13f2bbdc12v1d	реле
jqx-13f2bbdc12v1l	реле
jqx-13f2bbdc12v1ld	реле
jqx-13f2bbdc12v1nil	реле
jqx-13f2bbdc12v2d	реле
jqx-13f2bbdc12v2l	реле
jqx-13f2bbdc12v2ld	реле
jqx-13f2bbdc12v2nil	реле
jqx-13f2bbdc24v1d	реле
jqx-13f2bbdc24v1l	реле
jqx-13f2bbdc24v1ld	реле
jqx-13f2bbdc24v1nil	реле
jqx-13f2bbdc24v2d	реле
jqx-13f2bbdc24v2l	реле
jqx-13f2bbdc24v2ld	реле
jqx-13f2bbdc24v2nil	реле
jqx-13f2bbdc36v1d	реле
jqx-13f2bbdc36v1l	реле
jqx-13f2bbdc36v1ld	реле
jqx-13f2bbdc36v1nil	реле
jqx-13f2bbdc36v2d	реле
jqx-13f2bbdc36v2l	реле
jqx-13f2bbdc36v2ld	реле
jqx-13f2bbdc36v2nil	реле
jqx-13f2bbdc48v1d	реле
jqx-13f2bbdc48v1l	реле

jqx-13f2bbdc48v1d	реле
jqx-13f2bbdc48v1nil	реле
jqx-13f2bbdc48v2d	реле
jqx-13f2bbdc48v2l	реле
jqx-13f2bbdc48v2ld	реле
jqx-13f2bbdc48v2nil	реле
jqx-13f2caac110v1d	реле
jqx-13f2caac110v1l	реле
jqx-13f2caac110v1ld	реле
jqx-13f2caac110v1nil	реле
jqx-13f2caac110v2d	реле
jqx-13f2caac110v2l	реле
jqx-13f2caac110v2ld	реле
jqx-13f2caac110v2nil	реле
jqx-13f2caac12v1d	реле
jqx-13f2caac12v1l	реле
jqx-13f2caac12v1ld	реле
jqx-13f2caac12v1nil	реле
jqx-13f2caac12v2d	реле
jqx-13f2caac12v2l	реле
jqx-13f2caac12v2ld	реле
jqx-13f2caac12v2nil	реле
jqx-13f2caac24v1d	реле
jqx-13f2caac24v1l	реле
jqx-13f2caac24v1ld	реле
jqx-13f2caac24v1nil	реле
jqx-13f2caac24v2d	реле
jqx-13f2caac24v2l	реле

jqx-13f2caac24v2ld	реле
jqx-13f2caac24v2nil	реле
jqx-13f2caac36v1d	реле
jqx-13f2caac36v1l	реле
jqx-13f2caac36v1ld	реле
jqx-13f2caac36v1nil	реле
jqx-13f2caac36v2d	реле
jqx-13f2caac36v2l	реле
jqx-13f2caac36v2ld	реле
jqx-13f2caac36v2nil	реле
jqx-13f2caac48v1d	реле
jqx-13f2caac48v1l	реле
jqx-13f2caac48v1ld	реле
jqx-13f2caac48v1nil	реле
jqx-13f2caac48v2d	реле
jqx-13f2caac48v2l	реле
jqx-13f2caac48v2ld	реле
jqx-13f2caac48v2nil	реле
jqx-13f2cadc110v1d	реле
jqx-13f2cadc110v1l	реле
jqx-13f2cadc110v1ld	реле
jqx-13f2cadc110v1nil	реле
jqx-13f2cadc110v2d	реле
jqx-13f2cadc110v2l	реле
jqx-13f2cadc110v2ld	реле
jqx-13f2cadc110v2nil	реле
jqx-13f2cadc12v1d	реле
jqx-13f2cadc12v1l	реле

jqx-13f2cadc12v1d	реле
jqx-13f2cadc12v1nil	реле
jqx-13f2cadc12v2d	реле
jqx-13f2cadc12v2l	реле
jqx-13f2cadc12v2ld	реле
jqx-13f2cadc12v2nil	реле
jqx-13f2cadc24v1d	реле
jqx-13f2cadc24v1l	реле
jqx-13f2cadc24v1ld	реле
jqx-13f2cadc24v1nil	реле
jqx-13f2cadc24v2d	реле
jqx-13f2cadc24v2l	реле
jqx-13f2cadc24v2ld	реле
jqx-13f2cadc24v2nil	реле
jqx-13f2cadc36v1d	реле
jqx-13f2cadc36v1l	реле
jqx-13f2cadc36v1ld	реле
jqx-13f2cadc36v1nil	реле
jqx-13f2cadc36v2d	реле
jqx-13f2cadc36v2l	реле
jqx-13f2cadc36v2ld	реле
jqx-13f2cadc36v2nil	реле
jqx-13f2cadc48v1d	реле
jqx-13f2cadc48v1l	реле
jqx-13f2cadc48v1ld	реле
jqx-13f2cadc48v1nil	реле
jqx-13f2cadc48v2d	реле
jqx-13f2cadc48v2l	реле

jqx-13f2cad48v2ld	реле
jqx-13f2cad48v2nil	реле
jqx-13f2cbac110v1d	реле
jqx-13f2cbac110v1l	реле
jqx-13f2cbac110v1ld	реле
jqx-13f2cbac110v1nil	реле
jqx-13f2cbac110v2d	реле
jqx-13f2cbac110v2l	реле
jqx-13f2cbac110v2ld	реле
jqx-13f2cbac110v2nil	реле
jqx-13f2cbac12v1d	реле
jqx-13f2cbac12v1l	реле
jqx-13f2cbac12v1ld	реле
jqx-13f2cbac12v1nil	реле
jqx-13f2cbac12v2d	реле
jqx-13f2cbac12v2l	реле
jqx-13f2cbac12v2ld	реле
jqx-13f2cbac12v2nil	реле
jqx-13f2cbac24v1d	реле
jqx-13f2cbac24v1l	реле
jqx-13f2cbac24v1ld	реле
jqx-13f2cbac24v1nil	реле
jqx-13f2cbac24v2d	реле
jqx-13f2cbac24v2l	реле
jqx-13f2cbac24v2ld	реле
jqx-13f2cbac24v2nil	реле
jqx-13f2cbac36v1d	реле
jqx-13f2cbac36v1l	реле

jqx-13f2cbac36v1d	реле
jqx-13f2cbac36v1nil	реле
jqx-13f2cbac36v2d	реле
jqx-13f2cbac36v2l	реле
jqx-13f2cbac36v2ld	реле
jqx-13f2cbac36v2nil	реле
jqx-13f2cbac48v1d	реле
jqx-13f2cbac48v1l	реле
jqx-13f2cbac48v1ld	реле
jqx-13f2cbac48v1nil	реле
jqx-13f2cbac48v2d	реле
jqx-13f2cbac48v2l	реле
jqx-13f2cbac48v2ld	реле
jqx-13f2cbac48v2nil	реле
jqx-13f2cbdc110v1d	реле
jqx-13f2cbdc110v1l	реле
jqx-13f2cbdc110v1ld	реле
jqx-13f2cbdc110v1nil	реле
jqx-13f2cbdc110v2d	реле
jqx-13f2cbdc110v2l	реле
jqx-13f2cbdc110v2ld	реле
jqx-13f2cbdc110v2nil	реле
jqx-13f2cbdc12v1d	реле
jqx-13f2cbdc12v1l	реле
jqx-13f2cbdc12v1ld	реле
jqx-13f2cbdc12v1nil	реле
jqx-13f2cbdc12v2d	реле
jqx-13f2cbdc12v2l	реле

jqx-13f2cbdc12v2ld	реле
jqx-13f2cbdc12v2nil	реле
jqx-13f2cbdc24v1d	реле
jqx-13f2cbdc24v1l	реле
jqx-13f2cbdc24v1ld	реле
jqx-13f2cbdc24v1nil	реле
jqx-13f2cbdc24v2d	реле
jqx-13f2cbdc24v2l	реле
jqx-13f2cbdc24v2ld	реле
jqx-13f2cbdc24v2nil	реле
jqx-13f2cbdc36v1d	реле
jqx-13f2cbdc36v1l	реле
jqx-13f2cbdc36v1ld	реле
jqx-13f2cbdc36v1nil	реле
jqx-13f2cbdc36v2d	реле
jqx-13f2cbdc36v2l	реле
jqx-13f2cbdc36v2ld	реле
jqx-13f2cbdc36v2nil	реле
jqx-13f2cbdc48v1d	реле
jqx-13f2cbdc48v1l	реле
jqx-13f2cbdc48v1ld	реле
jqx-13f2cbdc48v1nil	реле
jqx-13f2cbdc48v2d	реле
jqx-13f2cbdc48v2l	реле
jqx-13f2cbdc48v2ld	реле
jqx-13f2cbdc48v2nil	реле
jqx-13f3саас110v1d	реле
jqx-13f3саас110v1l	реле

jqx-13f3caac110v1ld	реле
jqx-13f3caac110v1nil	реле
jqx-13f3caac110v2d	реле
jqx-13f3caac110v2l	реле
jqx-13f3caac110v2ld	реле
jqx-13f3caac110v2nil	реле
jqx-13f3caac12v1d	реле
jqx-13f3caac12v1l	реле
jqx-13f3caac12v1ld	реле
jqx-13f3caac12v1nil	реле
jqx-13f3caac12v2d	реле
jqx-13f3caac12v2l	реле
jqx-13f3caac12v2ld	реле
jqx-13f3caac12v2nil	реле
jqx-13f3caac24v1d	реле
jqx-13f3caac24v1l	реле
jqx-13f3caac24v1ld	реле
jqx-13f3caac24v1nil	реле
jqx-13f3caac24v2d	реле
jqx-13f3caac24v2l	реле
jqx-13f3caac24v2ld	реле
jqx-13f3caac24v2nil	реле
jqx-13f3caac36v1d	реле
jqx-13f3caac36v1l	реле
jqx-13f3caac36v1ld	реле
jqx-13f3caac36v1nil	реле
jqx-13f3caac36v2d	реле
jqx-13f3caac36v2l	реле

jqx-13f3caac36v2ld	реле
jqx-13f3caac36v2nil	реле
jqx-13f3caac48v1d	реле
jqx-13f3caac48v1l	реле
jqx-13f3caac48v1ld	реле
jqx-13f3caac48v1nil	реле
jqx-13f3caac48v2d	реле
jqx-13f3caac48v2l	реле
jqx-13f3caac48v2ld	реле
jqx-13f3caac48v2nil	реле
jqx-13f3cadc110v1d	реле
jqx-13f3cadc110v1l	реле
jqx-13f3cadc110v1ld	реле
jqx-13f3cadc110v1nil	реле
jqx-13f3cadc110v2d	реле
jqx-13f3cadc110v2l	реле
jqx-13f3cadc110v2ld	реле
jqx-13f3cadc110v2nil	реле
jqx-13f3cadc12v1d	реле
jqx-13f3cadc12v1l	реле
jqx-13f3cadc12v1ld	реле
jqx-13f3cadc12v1nil	реле
jqx-13f3cadc12v2d	реле
jqx-13f3cadc12v2l	реле
jqx-13f3cadc12v2ld	реле
jqx-13f3cadc12v2nil	реле
jqx-13f3cadc24v1d	реле
jqx-13f3cadc24v1l	реле

jqx-13f3cadc24v1d	реле
jqx-13f3cadc24v1nil	реле
jqx-13f3cadc24v2d	реле
jqx-13f3cadc24v2l	реле
jqx-13f3cadc24v2ld	реле
jqx-13f3cadc24v2nil	реле
jqx-13f3cadc36v1d	реле
jqx-13f3cadc36v1l	реле
jqx-13f3cadc36v1ld	реле
jqx-13f3cadc36v1nil	реле
jqx-13f3cadc36v2d	реле
jqx-13f3cadc36v2l	реле
jqx-13f3cadc36v2ld	реле
jqx-13f3cadc36v2nil	реле
jqx-13f3cadc48v1d	реле
jqx-13f3cadc48v1l	реле
jqx-13f3cadc48v1ld	реле
jqx-13f3cadc48v1nil	реле
jqx-13f3cadc48v2d	реле
jqx-13f3cadc48v2l	реле
jqx-13f3cadc48v2ld	реле
jqx-13f3cadc48v2nil	реле
jqx-13f3cbac110v1d	реле
jqx-13f3cbac110v1l	реле
jqx-13f3cbac110v1ld	реле
jqx-13f3cbac110v1nil	реле
jqx-13f3cbac110v2d	реле
jqx-13f3cbac110v2l	реле

jqx-13f3cbac110v2ld	реле
jqx-13f3cbac110v2nil	реле
jqx-13f3cbac12v1d	реле
jqx-13f3cbac12v1l	реле
jqx-13f3cbac12v1ld	реле
jqx-13f3cbac12v1nil	реле
jqx-13f3cbac12v2d	реле
jqx-13f3cbac12v2l	реле
jqx-13f3cbac12v2ld	реле
jqx-13f3cbac12v2nil	реле
jqx-13f3cbac24v1d	реле
jqx-13f3cbac24v1l	реле
jqx-13f3cbac24v1ld	реле
jqx-13f3cbac24v1nil	реле
jqx-13f3cbac24v2d	реле
jqx-13f3cbac24v2l	реле
jqx-13f3cbac24v2ld	реле
jqx-13f3cbac24v2nil	реле
jqx-13f3cbac36v1d	реле
jqx-13f3cbac36v1l	реле
jqx-13f3cbac36v1ld	реле
jqx-13f3cbac36v1nil	реле
jqx-13f3cbac36v2d	реле
jqx-13f3cbac36v2l	реле
jqx-13f3cbac36v2ld	реле
jqx-13f3cbac36v2nil	реле
jqx-13f3cbac48v1d	реле
jqx-13f3cbac48v1l	реле

jqx-13f3cbac48v1d	реле
jqx-13f3cbac48v1nil	реле
jqx-13f3cbac48v2d	реле
jqx-13f3cbac48v2l	реле
jqx-13f3cbac48v2ld	реле
jqx-13f3cbac48v2nil	реле
jqx-13f3cbdc110v1d	реле
jqx-13f3cbdc110v1l	реле
jqx-13f3cbdc110v1ld	реле
jqx-13f3cbdc110v1nil	реле
jqx-13f3cbdc110v2d	реле
jqx-13f3cbdc110v2l	реле
jqx-13f3cbdc110v2ld	реле
jqx-13f3cbdc110v2nil	реле
jqx-13f3cbdc12v1d	реле
jqx-13f3cbdc12v1l	реле
jqx-13f3cbdc12v1ld	реле
jqx-13f3cbdc12v1nil	реле
jqx-13f3cbdc12v2d	реле
jqx-13f3cbdc12v2l	реле
jqx-13f3cbdc12v2ld	реле
jqx-13f3cbdc12v2nil	реле
jqx-13f3cbdc24v1d	реле
jqx-13f3cbdc24v1l	реле
jqx-13f3cbdc24v1ld	реле
jqx-13f3cbdc24v1nil	реле
jqx-13f3cbdc24v2d	реле
jqx-13f3cbdc24v2l	реле

jqx-13f3cbdc24v2ld	реле
jqx-13f3cbdc24v2nil	реле
jqx-13f3cbdc36v1d	реле
jqx-13f3cbdc36v1l	реле
jqx-13f3cbdc36v1ld	реле
jqx-13f3cbdc36v1nil	реле
jqx-13f3cbdc36v2d	реле
jqx-13f3cbdc36v2l	реле
jqx-13f3cbdc36v2ld	реле
jqx-13f3cbdc36v2nil	реле
jqx-13f3cbdc48v1d	реле
jqx-13f3cbdc48v1l	реле
jqx-13f3cbdc48v1ld	реле
jqx-13f3cbdc48v1nil	реле
jqx-13f3cbdc48v2d	реле
jqx-13f3cbdc48v2l	реле
jqx-13f3cbdc48v2ld	реле
jqx-13f3cbdc48v2nil	реле
jqx-13f4саас110v1d	реле
jqx-13f4саас110v1l	реле
jqx-13f4саас110v1ld	реле
jqx-13f4саас110v1nil	реле
jqx-13f4саас110v2d	реле
jqx-13f4саас110v2l	реле
jqx-13f4саас110v2ld	реле
jqx-13f4саас110v2nil	реле
jqx-13f4саас12v1d	реле
jqx-13f4саас12v1l	реле

jqx-13f4caac12v1ld	реле
jqx-13f4caac12v1nil	реле
jqx-13f4caac12v2d	реле
jqx-13f4caac12v2l	реле
jqx-13f4caac12v2ld	реле
jqx-13f4caac12v2nil	реле
jqx-13f4caac24v1d	реле
jqx-13f4caac24v1l	реле
jqx-13f4caac24v1ld	реле
jqx-13f4caac24v1nil	реле
jqx-13f4caac24v2d	реле
jqx-13f4caac24v2l	реле
jqx-13f4caac24v2ld	реле
jqx-13f4caac24v2nil	реле
jqx-13f4caac36v1d	реле
jqx-13f4caac36v1l	реле
jqx-13f4caac36v1ld	реле
jqx-13f4caac36v1nil	реле
jqx-13f4caac36v2d	реле
jqx-13f4caac36v2l	реле
jqx-13f4caac36v2ld	реле
jqx-13f4caac36v2nil	реле
jqx-13f4caac48v1d	реле
jqx-13f4caac48v1l	реле
jqx-13f4caac48v1ld	реле
jqx-13f4caac48v1nil	реле
jqx-13f4caac48v2d	реле
jqx-13f4caac48v2l	реле

jqx-13f4caac48v2ld	реле
jqx-13f4caac48v2nil	реле
jqx-13f4cadc110v1d	реле
jqx-13f4cadc110v1l	реле
jqx-13f4cadc110v1ld	реле
jqx-13f4cadc110v1nil	реле
jqx-13f4cadc110v2d	реле
jqx-13f4cadc110v2l	реле
jqx-13f4cadc110v2ld	реле
jqx-13f4cadc110v2nil	реле
jqx-13f4cadc12v1d	реле
jqx-13f4cadc12v1l	реле
jqx-13f4cadc12v1ld	реле
jqx-13f4cadc12v1nil	реле
jqx-13f4cadc12v2d	реле
jqx-13f4cadc12v2l	реле
jqx-13f4cadc12v2ld	реле
jqx-13f4cadc12v2nil	реле
jqx-13f4cadc24v1d	реле
jqx-13f4cadc24v1l	реле
jqx-13f4cadc24v1ld	реле
jqx-13f4cadc24v1nil	реле
jqx-13f4cadc24v2d	реле
jqx-13f4cadc24v2l	реле
jqx-13f4cadc24v2ld	реле
jqx-13f4cadc24v2nil	реле
jqx-13f4cadc36v1d	реле
jqx-13f4cadc36v1l	реле

jqx-13f4cad36v1d	реле
jqx-13f4cad36v1nil	реле
jqx-13f4cad36v2d	реле
jqx-13f4cad36v2l	реле
jqx-13f4cad36v2ld	реле
jqx-13f4cad36v2nil	реле
jqx-13f4cad48v1d	реле
jqx-13f4cad48v1l	реле
jqx-13f4cad48v1ld	реле
jqx-13f4cad48v1nil	реле
jqx-13f4cad48v2d	реле
jqx-13f4cad48v2l	реле
jqx-13f4cad48v2ld	реле
jqx-13f4cad48v2nil	реле
jqx-13f4cbac110v1d	реле
jqx-13f4cbac110v1l	реле
jqx-13f4cbac110v1ld	реле
jqx-13f4cbac110v1nil	реле
jqx-13f4cbac110v2d	реле
jqx-13f4cbac110v2l	реле
jqx-13f4cbac110v2ld	реле
jqx-13f4cbac110v2nil	реле
jqx-13f4cbac12v1d	реле
jqx-13f4cbac12v1l	реле
jqx-13f4cbac12v1ld	реле
jqx-13f4cbac12v1nil	реле
jqx-13f4cbac12v2d	реле
jqx-13f4cbac12v2l	реле

jqx-13f4cbac12v2ld	реле
jqx-13f4cbac12v2nil	реле
jqx-13f4cbac24v1d	реле
jqx-13f4cbac24v1l	реле
jqx-13f4cbac24v1ld	реле
jqx-13f4cbac24v1nil	реле
jqx-13f4cbac24v2d	реле
jqx-13f4cbac24v2l	реле
jqx-13f4cbac24v2ld	реле
jqx-13f4cbac24v2nil	реле
jqx-13f4cbac36v1d	реле
jqx-13f4cbac36v1l	реле
jqx-13f4cbac36v1ld	реле
jqx-13f4cbac36v1nil	реле
jqx-13f4cbac36v2d	реле
jqx-13f4cbac36v2l	реле
jqx-13f4cbac36v2ld	реле
jqx-13f4cbac36v2nil	реле
jqx-13f4cbac48v1d	реле
jqx-13f4cbac48v1l	реле
jqx-13f4cbac48v1ld	реле
jqx-13f4cbac48v1nil	реле
jqx-13f4cbac48v2d	реле
jqx-13f4cbac48v2l	реле
jqx-13f4cbac48v2ld	реле
jqx-13f4cbac48v2nil	реле
jqx-13f4cbdc110v1d	реле
jqx-13f4cbdc110v1l	реле

jqx-13f4cbdc110v1d	реле
jqx-13f4cbdc110v1nil	реле
jqx-13f4cbdc110v2d	реле
jqx-13f4cbdc110v2l	реле
jqx-13f4cbdc110v2ld	реле
jqx-13f4cbdc110v2nil	реле
jqx-13f4cbdc12v1d	реле
jqx-13f4cbdc12v1l	реле
jqx-13f4cbdc12v1ld	реле
jqx-13f4cbdc12v1nil	реле
jqx-13f4cbdc12v2d	реле
jqx-13f4cbdc12v2l	реле
jqx-13f4cbdc12v2ld	реле
jqx-13f4cbdc12v2nil	реле
jqx-13f4cbdc24v1d	реле
jqx-13f4cbdc24v1l	реле
jqx-13f4cbdc24v1ld	реле
jqx-13f4cbdc24v1nil	реле
jqx-13f4cbdc24v2d	реле
jqx-13f4cbdc24v2l	реле
jqx-13f4cbdc24v2ld	реле
jqx-13f4cbdc24v2nil	реле
jqx-13f4cbdc36v1d	реле
jqx-13f4cbdc36v1l	реле
jqx-13f4cbdc36v1ld	реле
jqx-13f4cbdc36v1nil	реле
jqx-13f4cbdc36v2d	реле
jqx-13f4cbdc36v2l	реле

jqx-13f4cbdc36v2ld	реле
jqx-13f4cbdc36v2nil	реле
jqx-13f4cbdc48v1d	реле
jqx-13f4cbdc48v1l	реле
jqx-13f4cbdc48v1ld	реле
jqx-13f4cbdc48v1nil	реле
jqx-13f4cbdc48v2d	реле
jqx-13f4cbdc48v2l	реле
jqx-13f4cbdc48v2ld	реле
jqx-13f4cbdc48v2nil	реле
jqx-140ff	etc1 [list of unclassified manufacturers], double-pole, 10a, pc board
jqx-141ff	реле
jqx-141ff/005dnlnilg	реле
jqx-141ff/005dnlnlnil	реле
jqx-141ff/005dnlnpg	реле
jqx-141ff/005dnlnpnil	реле
jqx-141ff/005dsnilg	реле
jqx-141ff/005dsnilnil	реле
jqx-141ff/005dspg	реле
jqx-141ff/005dspnil	реле
jqx-141ff/005hlnilng	реле
jqx-141ff/005hlnlnilnil	реле
jqx-141ff/005hlnlnpg	реле
jqx-141ff/005hlnlnpnil	реле
jqx-141ff/005hsnilg	реле
jqx-141ff/005hsnilnil	реле
jqx-141ff/005hsnpg	реле
jqx-141ff/005hsnlnil	реле

jqx-141ff/005znilnilg	реле
jqx-141ff/005znilnilnil	реле
jqx-141ff/005znilpg	реле
jqx-141ff/005znilpnil	реле
jqx-141ff/005zsnilg	реле
jqx-141ff/005zsnilnil	реле
jqx-141ff/005zspg	реле
jqx-141ff/005zspnil	реле
jqx-141ff/006dnilnilg	реле
jqx-141ff/006dnilnilnil	реле
jqx-141ff/006dnilpg	реле
jqx-141ff/006dnilpnil	реле
jqx-141ff/006dsnilg	реле
jqx-141ff/006dsnilnil	реле
jqx-141ff/006dspg	реле
jqx-141ff/006dspnil	реле
jqx-141ff/006hnilnilg	реле
jqx-141ff/006hnilnilnil	реле
jqx-141ff/006hnilpg	реле
jqx-141ff/006hnilpnil	реле
jqx-141ff/006hsnilg	реле
jqx-141ff/006hsnilnil	реле
jqx-141ff/006hspg	реле
jqx-141ff/006hspnil	реле
jqx-141ff/006znilnilg	реле
jqx-141ff/006znilnilnil	реле
jqx-141ff/006znilpg	реле
jqx-141ff/006znilpnil	реле

jqx-141ff/006zsnilg	реле
jqx-141ff/006zsnilnil	реле
jqx-141ff/006zspg	реле
jqx-141ff/006zspnil	реле
jqx-141ff/009dnilnilg	реле
jqx-141ff/009dnilnilnil	реле
jqx-141ff/009dnilpg	реле
jqx-141ff/009dnilpnil	реле
jqx-141ff/009dsnild	реле
jqx-141ff/009dsnildnil	реле
jqx-141ff/009dspg	реле
jqx-141ff/009dspnil	реле
jqx-141ff/009hnilnilg	реле
jqx-141ff/009hnilnilnil	реле
jqx-141ff/009hnilpg	реле
jqx-141ff/009hnilpnil	реле
jqx-141ff/009hsnild	реле
jqx-141ff/009hsnildnil	реле
jqx-141ff/009hspg	реле
jqx-141ff/009hspnil	реле
jqx-141ff/009znildnilg	реле
jqx-141ff/009znildnilnil	реле
jqx-141ff/009znildpg	реле
jqx-141ff/009znildpnil	реле
jqx-141ff/009zsnild	реле
jqx-141ff/009zsnildnil	реле
jqx-141ff/009zspg	реле
jqx-141ff/009zspnil	реле

jqx-141ff/012dnlnilg реле
jqx-141ff/012dnlnlnil реле
jqx-141ff/012dnlnpg реле
jqx-141ff/012dnlnpnil реле
jqx-141ff/012dsnilg реле
jqx-141ff/012dsnilnil реле
jqx-141ff/012dspg реле
jqx-141ff/012dspnil реле
jqx-141ff/012hlnilng реле
jqx-141ff/012hlnlnlnil реле
jqx-141ff/012hlnlnpg реле
jqx-141ff/012hlnlnpnil реле
jqx-141ff/012hsnilg реле
jqx-141ff/012hsnilnil реле
jqx-141ff/012hspg реле
jqx-141ff/012hspnil реле
jqx-141ff/012znlnilg реле
jqx-141ff/012znlnlnlnil реле
jqx-141ff/012znlnpg реле
jqx-141ff/012znlnpnil реле
jqx-141ff/012zsnilg реле
jqx-141ff/012zsnlnlnil реле
jqx-141ff/012zspg реле
jqx-141ff/012zspnil реле
jqx-141ff/018dnlnilg реле
jqx-141ff/018dnlnlnlnil реле
jqx-141ff/018dnlnpg реле
jqx-141ff/018dnlnpnil реле

jqx-141ff/018dsnilg	реле
jqx-141ff/018dsnilnil	реле
jqx-141ff/018dspg	реле
jqx-141ff/018dspnil	реле
jqx-141ff/018hnilnilg	реле
jqx-141ff/018hnilnilnil	реле
jqx-141ff/018hnilpg	реле
jqx-141ff/018hnilpnil	реле
jqx-141ff/018hsnilg	реле
jqx-141ff/018hsnilnil	реле
jqx-141ff/018hspg	реле
jqx-141ff/018hspnil	реле
jqx-141ff/018znilnilg	реле
jqx-141ff/018znilnilnil	реле
jqx-141ff/018znilpg	реле
jqx-141ff/018znilpnil	реле
jqx-141ff/018zsnilg	реле
jqx-141ff/018zsnilnil	реле
jqx-141ff/018zspg	реле
jqx-141ff/018zspnil	реле
jqx-141ff/024dnilnilg	реле
jqx-141ff/024dnilnilnil	реле
jqx-141ff/024dnilpg	реле
jqx-141ff/024dnilpnil	реле
jqx-141ff/024dsnilg	реле
jqx-141ff/024dsnilnil	реле
jqx-141ff/024dspg	реле
jqx-141ff/024dspnil	реле

jqx-141ff/024hnilnilg	реле
jqx-141ff/024hnilnilnil	реле
jqx-141ff/024hnilpg	реле
jqx-141ff/024hnilpnil	реле
jqx-141ff/024hsnilg	реле
jqx-141ff/024hsnilnil	реле
jqx-141ff/024hspg	реле
jqx-141ff/024hspnil	реле
jqx-141ff/024znilnilg	реле
jqx-141ff/024znilnilnil	реле
jqx-141ff/024znilpg	реле
jqx-141ff/024znilpnil	реле
jqx-141ff/024zsnilg	реле
jqx-141ff/024zsnilnil	реле
jqx-141ff/024zspg	реле
jqx-141ff/024zspnil	реле
jqx-141ff/048dnilnilg	реле
jqx-141ff/048dnilnilnil	реле
jqx-141ff/048dnilpg	реле
jqx-141ff/048dnilpnil	реле
jqx-141ff/048dsnlg	реле
jqx-141ff/048dsnlg	реле
jqx-141ff/048dspg	реле
jqx-141ff/048dspnil	реле
jqx-141ff/048hnilnilg	реле
jqx-141ff/048hnilnilnil	реле
jqx-141ff/048hnilpg	реле
jqx-141ff/048hnilpnil	реле

jqx-141ff/048hsnilg	реле
jqx-141ff/048hsnilnil	реле
jqx-141ff/048hspg	реле
jqx-141ff/048hsnil	реле
jqx-141ff/048znilnilg	реле
jqx-141ff/048znilnilnil	реле
jqx-141ff/048znilpg	реле
jqx-141ff/048znilpnil	реле
jqx-141ff/048zsnilg	реле
jqx-141ff/048zsnilnil	реле
jqx-141ff/048zspg	реле
jqx-141ff/048zspnil	реле
jqx-141ff1as10adc30.543.3	реле switching capacity from 10a to 16a
jqx-141ff1as10adc50.543.3	реле switching capacity from 10a to 16a
jqx-141ff1as10adc60.543.3	реле switching capacity from 10a to 16a
jqx-141ff1as10adc90.543.3	реле switching capacity from 10a to 16a
jqx-141ff1as16adc30.543.3	реле switching capacity from 10a to 16a
jqx-141ff1as16adc50.543.3	реле switching capacity from 10a to 16a
jqx-141ff1as16adc60.543.3	реле switching capacity from 10a to 16a
jqx-141ff1as16adc90.543.3	реле switching capacity from 10a to 16a
jqx-141ff1as5adc120.543.3	реле switching capacity from 10a to 16a
jqx-141ff1as5adc30.543.3	реле switching capacity from 10a to 16a
jqx-141ff1as5adc50.543.3	реле switching capacity from 10a to 16a
jqx-141ff1as5adc60.543.3	реле switching capacity from 10a to 16a
jqx-141ff1as5adc90.543.3	реле switching capacity from 10a to 16a
jqx-141ff1as8adc120.543.3	реле switching capacity from 10a to 16a
jqx-141ff1as8adc30.543.3	реле switching capacity from 10a to 16a
jqx-141ff1as8adc50.543.3	реле switching capacity from 10a to 16a

jqx-141ff1as8adc60.543.3	реле switching capacity from 10a to 16a
jqx-141ff1as8adc90.543.3	реле switching capacity from 10a to 16a
jqx-141ff1az10adc30.543.3	реле switching capacity from 10a to 16a
jqx-141ff1az10adc50.543.3	реле switching capacity from 10a to 16a
jqx-141ff1az10adc60.543.3	реле switching capacity from 10a to 16a
jqx-141ff1az10adc90.543.3	реле switching capacity from 10a to 16a
jqx-141ff1az16adc30.543.3	реле switching capacity from 10a to 16a
jqx-141ff1az16adc50.543.3	реле switching capacity from 10a to 16a
jqx-141ff1az16adc60.543.3	реле switching capacity from 10a to 16a
jqx-141ff1az16adc90.543.3	реле switching capacity from 10a to 16a
jqx-141ff1az5adc120.543.3	реле switching capacity from 10a to 16a
jqx-141ff1az5adc30.543.3	реле switching capacity from 10a to 16a
jqx-141ff1az5adc50.543.3	реле switching capacity from 10a to 16a
jqx-141ff1az5adc60.543.3	реле switching capacity from 10a to 16a
jqx-141ff1az5adc90.543.3	реле switching capacity from 10a to 16a
jqx-141ff1az8adc120.543.3	реле switching capacity from 10a to 16a
jqx-141ff1az8adc30.543.3	реле switching capacity from 10a to 16a
jqx-141ff1az8adc50.543.3	реле switching capacity from 10a to 16a
jqx-141ff1az8adc60.543.3	реле switching capacity from 10a to 16a
jqx-141ff1az8adc90.543.3	реле switching capacity from 10a to 16a
jqx-141ff1cs10adc30.543.3	реле switching capacity from 10a to 16a
jqx-141ff1cs10adc50.543.3	реле switching capacity from 10a to 16a
jqx-141ff1cs10adc60.543.3	реле switching capacity from 10a to 16a
jqx-141ff1cs10adc90.543.3	реле switching capacity from 10a to 16a
jqx-141ff1cs16adc30.543.3	реле switching capacity from 10a to 16a
jqx-141ff1cs16adc50.543.3	реле switching capacity from 10a to 16a
jqx-141ff1cs16adc60.543.3	реле switching capacity from 10a to 16a
jqx-141ff1cs16adc90.543.3	реле switching capacity from 10a to 16a

jqx-141ff1cs5adc120.543.3	реле switching capacity from 10a to 16a
jqx-141ff1cs5adc30.543.3	реле switching capacity from 10a to 16a
jqx-141ff1cs5adc50.543.3	реле switching capacity from 10a to 16a
jqx-141ff1cs5adc60.543.3	реле switching capacity from 10a to 16a
jqx-141ff1cs5adc90.543.3	реле switching capacity from 10a to 16a
jqx-141ff1cs8adc120.543.3	реле switching capacity from 10a to 16a
jqx-141ff1cs8adc30.543.3	реле switching capacity from 10a to 16a
jqx-141ff1cs8adc50.543.3	реле switching capacity from 10a to 16a
jqx-141ff1cs8adc60.543.3	реле switching capacity from 10a to 16a
jqx-141ff1cs8adc90.543.3	реле switching capacity from 10a to 16a
jqx-141ff1cz10adc30.543.3	реле switching capacity from 10a to 16a
jqx-141ff1cz10adc50.543.3	реле switching capacity from 10a to 16a
jqx-141ff1cz10adc60.543.3	реле switching capacity from 10a to 16a
jqx-141ff1cz10adc90.543.3	реле switching capacity from 10a to 16a
jqx-141ff1cz16adc30.543.3	реле switching capacity from 10a to 16a
jqx-141ff1cz16adc50.543.3	реле switching capacity from 10a to 16a
jqx-141ff1cz16adc60.543.3	реле switching capacity from 10a to 16a
jqx-141ff1cz16adc90.543.3	реле switching capacity from 10a to 16a
jqx-141ff1cz5adc120.543.3	реле switching capacity from 10a to 16a
jqx-141ff1cz5adc30.543.3	реле switching capacity from 10a to 16a
jqx-141ff1cz5adc50.543.3	реле switching capacity from 10a to 16a
jqx-141ff1cz5adc60.543.3	реле switching capacity from 10a to 16a
jqx-141ff1cz5adc90.543.3	реле switching capacity from 10a to 16a
jqx-141ff1cz8adc120.543.3	реле switching capacity from 10a to 16a
jqx-141ff1cz8adc30.543.3	реле switching capacity from 10a to 16a
jqx-141ff1cz8adc50.543.3	реле switching capacity from 10a to 16a
jqx-141ff1cz8adc60.543.3	реле switching capacity from 10a to 16a
jqx-141ff1cz8adc90.543.3	реле switching capacity from 10a to 16a

jqx-141ff2as10adc30.543.3	реле switching capacity from 10a to 16a
jqx-141ff2as10adc50.543.3	реле switching capacity from 10a to 16a
jqx-141ff2as10adc60.543.3	реле switching capacity from 10a to 16a
jqx-141ff2as10adc90.543.3	реле switching capacity from 10a to 16a
jqx-141ff2as16adc30.543.3	реле switching capacity from 10a to 16a
jqx-141ff2as16adc50.543.3	реле switching capacity from 10a to 16a
jqx-141ff2as16adc60.543.3	реле switching capacity from 10a to 16a
jqx-141ff2as16adc90.543.3	реле switching capacity from 10a to 16a
jqx-141ff2as5adc120.543.3	реле switching capacity from 10a to 16a
jqx-141ff2as5adc30.543.3	реле switching capacity from 10a to 16a
jqx-141ff2as5adc50.543.3	реле switching capacity from 10a to 16a
jqx-141ff2as5adc60.543.3	реле switching capacity from 10a to 16a
jqx-141ff2as5adc90.543.3	реле switching capacity from 10a to 16a
jqx-141ff2as8adc120.543.3	реле switching capacity from 10a to 16a
jqx-141ff2as8adc30.543.3	реле switching capacity from 10a to 16a
jqx-141ff2as8adc50.543.3	реле switching capacity from 10a to 16a
jqx-141ff2as8adc60.543.3	реле switching capacity from 10a to 16a
jqx-141ff2as8adc90.543.3	реле switching capacity from 10a to 16a
jqx-141ff2az10adc30.543.3	реле switching capacity from 10a to 16a
jqx-141ff2az10adc50.543.3	реле switching capacity from 10a to 16a
jqx-141ff2az10adc60.543.3	реле switching capacity from 10a to 16a
jqx-141ff2az10adc90.543.3	реле switching capacity from 10a to 16a
jqx-141ff2az16adc30.543.3	реле switching capacity from 10a to 16a
jqx-141ff2az16adc50.543.3	реле switching capacity from 10a to 16a
jqx-141ff2az16adc60.543.3	реле switching capacity from 10a to 16a
jqx-141ff2az16adc90.543.3	реле switching capacity from 10a to 16a
jqx-141ff2az5adc120.543.3	реле switching capacity from 10a to 16a
jqx-141ff2az5adc30.543.3	реле switching capacity from 10a to 16a

jqx-141ff2az5adc50.543.3	реле switching capacity from 10a to 16a
jqx-141ff2az5adc60.543.3	реле switching capacity from 10a to 16a
jqx-141ff2az5adc90.543.3	реле switching capacity from 10a to 16a
jqx-141ff2az8adc120.543.3	реле switching capacity from 10a to 16a
jqx-141ff2az8adc30.543.3	реле switching capacity from 10a to 16a
jqx-141ff2az8adc50.543.3	реле switching capacity from 10a to 16a
jqx-141ff2az8adc60.543.3	реле switching capacity from 10a to 16a
jqx-141ff2az8adc90.543.3	реле switching capacity from 10a to 16a
jqx-141ff2cs10adc30.543.3	реле switching capacity from 10a to 16a
jqx-141ff2cs10adc50.543.3	реле switching capacity from 10a to 16a
jqx-141ff2cs10adc60.543.3	реле switching capacity from 10a to 16a
jqx-141ff2cs10adc90.543.3	реле switching capacity from 10a to 16a
jqx-141ff2cs16adc30.543.3	реле switching capacity from 10a to 16a
jqx-141ff2cs16adc50.543.3	реле switching capacity from 10a to 16a
jqx-141ff2cs16adc60.543.3	реле switching capacity from 10a to 16a
jqx-141ff2cs16adc90.543.3	реле switching capacity from 10a to 16a
jqx-141ff2cs5adc120.543.3	реле switching capacity from 10a to 16a
jqx-141ff2cs5adc30.543.3	реле switching capacity from 10a to 16a
jqx-141ff2cs5adc50.543.3	реле switching capacity from 10a to 16a
jqx-141ff2cs5adc60.543.3	реле switching capacity from 10a to 16a
jqx-141ff2cs5adc90.543.3	реле switching capacity from 10a to 16a
jqx-141ff2cs8adc120.543.3	реле switching capacity from 10a to 16a
jqx-141ff2cs8adc30.543.3	реле switching capacity from 10a to 16a
jqx-141ff2cs8adc50.543.3	реле switching capacity from 10a to 16a
jqx-141ff2cs8adc60.543.3	реле switching capacity from 10a to 16a
jqx-141ff2cs8adc90.543.3	реле switching capacity from 10a to 16a
jqx-141ff2cz10adc30.543.3	реле switching capacity from 10a to 16a
jqx-141ff2cz10adc50.543.3	реле switching capacity from 10a to 16a

jqx-141ff2cz10adc60.543.3	реле switching capacity from 10a to 16a
jqx-141ff2cz10adc90.543.3	реле switching capacity from 10a to 16a
jqx-141ff2cz16adc30.543.3	реле switching capacity from 10a to 16a
jqx-141ff2cz16adc50.543.3	реле switching capacity from 10a to 16a
jqx-141ff2cz16adc60.543.3	реле switching capacity from 10a to 16a
jqx-141ff2cz16adc90.543.3	реле switching capacity from 10a to 16a
jqx-141ff2cz5adc120.543.3	реле switching capacity from 10a to 16a
jqx-141ff2cz5adc30.543.3	реле switching capacity from 10a to 16a
jqx-141ff2cz5adc50.543.3	реле switching capacity from 10a to 16a
jqx-141ff2cz5adc60.543.3	реле switching capacity from 10a to 16a
jqx-141ff2cz5adc90.543.3	реле switching capacity from 10a to 16a
jqx-141ff2cz8adc120.543.3	реле switching capacity from 10a to 16a
jqx-141ff2cz8adc30.543.3	реле switching capacity from 10a to 16a
jqx-141ff2cz8adc50.543.3	реле switching capacity from 10a to 16a
jqx-141ff2cz8adc60.543.3	реле switching capacity from 10a to 16a
jqx-141ff2cz8adc90.543.3	реле switching capacity from 10a to 16a
jqx-14f-w012-z glenair	
jqx-14fc	релес
jqx-14fc-2c-12v группа:	реле, описание: тип контактов: 2с; икатушки: 12в; , габариты: 29x12,8x26мм
jqx-14fc-2c-24v группа:	реле, описание: тип контактов: 2с; икатушки: 24в; , габариты: 29x12,8x26мм
jqx-14fc1	ningbo forward relay corporation
jqx-14fc12as10	релес
jqx-14fc12as16	релес
jqx-14fc12as20	релес
jqx-14fc12as3	релес
jqx-14fc12as5	релес
jqx-14fc12as6	релес
jqx-14fc12as8	релес

jqx-14fc12az10 релес
jqx-14fc12az16 релес
jqx-14fc12az20 релес
jqx-14fc12az3 релес
jqx-14fc12az5 релес
jqx-14fc12az6 релес
jqx-14fc12az8 релес
jqx-14fc12cs10 релес
jqx-14fc12cs16 релес
jqx-14fc12cs20 релес
jqx-14fc12cs3 релес
jqx-14fc12cs5 релес
jqx-14fc12cs6 релес
jqx-14fc12cs8 релес
jqx-14fc12cz10 релес
jqx-14fc12cz16 релес
jqx-14fc12cz20 релес
jqx-14fc12cz3 релес
jqx-14fc12cz5 релес
jqx-14fc12cz6 релес
jqx-14fc12cz8 релес
jqx-14fc1as10 релес
jqx-14fc1as16 релес
jqx-14fc1as20 релес
jqx-14fc1as3 релес
jqx-14fc1as5 релес
jqx-14fc1as6 релес
jqx-14fc1as8 релес

jqx-14fc1az10 релес
jqx-14fc1az16 релес
jqx-14fc1az20 релес
jqx-14fc1az3 релес
jqx-14fc1az5 релес
jqx-14fc1az6 релес
jqx-14fc1az8 релес
jqx-14fc1cs10 релес
jqx-14fc1cs16 релес
jqx-14fc1cs16dc12v5.0 ningbo forward relay corporation ltd
jqx-14fc1cs20 релес
jqx-14fc1cs3 релес
jqx-14fc1cs5 релес
jqx-14fc1cs6 релес
jqx-14fc1cs8 релес
jqx-14fc1cz10 релес
jqx-14fc1cz16 релес
jqx-14fc1cz20 релес
jqx-14fc1cz3 релес
jqx-14fc1cz5 релес
jqx-14fc1cz6 релес
jqx-14fc1cz8 релес
jqx-14fc2 ningbo forward relay corporation
jqx-14fc22as10 релес
jqx-14fc22as16 релес
jqx-14fc22as20 релес
jqx-14fc22as3 релес
jqx-14fc22as5 релес

jqx-14fc22as6 релес
jqx-14fc22as8 релес
jqx-14fc22az10 релес
jqx-14fc22az16 релес
jqx-14fc22az20 релес
jqx-14fc22az3 релес
jqx-14fc22az5 релес
jqx-14fc22az6 релес
jqx-14fc22az8 релес
jqx-14fc22cs10 релес
jqx-14fc22cs16 релес
jqx-14fc22cs20 релес
jqx-14fc22cs3 релес
jqx-14fc22cs5 релес
jqx-14fc22cs6 релес
jqx-14fc22cs8 релес
jqx-14fc22cz10 релес
jqx-14fc22cz16 релес
jqx-14fc22cz20 релес
jqx-14fc22cz3 релес
jqx-14fc22cz5 релес
jqx-14fc22cz6 релес
jqx-14fc22cz8 релес
jqx-14fc2as10 релес
jqx-14fc2as10aac120.83.5 реле
jqx-14fc2as10aac120.85 реле
jqx-14fc2as10aac121.23.5 реле
jqx-14fc2as10aac121.25 реле

jqx-14fc2as10aac1213.5	реле
jqx-14fc2as10aac1215	реле
jqx-14fc2as10aac12nil3.5	реле
jqx-14fc2as10aac12nil5	реле
jqx-14fc2as10aac240.83.5	реле
jqx-14fc2as10aac240.85	реле
jqx-14fc2as10aac241.23.5	реле
jqx-14fc2as10aac241.25	реле
jqx-14fc2as10aac2413.5	реле
jqx-14fc2as10aac2415	реле
jqx-14fc2as10aac24nil3.5	реле
jqx-14fc2as10aac24nil5	реле
jqx-14fc2as10aac60.83.5	реле
jqx-14fc2as10aac60.85	реле
jqx-14fc2as10aac61.23.5	реле
jqx-14fc2as10aac61.25	реле
jqx-14fc2as10aac613.5	реле
jqx-14fc2as10aac615	реле
jqx-14fc2as10aac6nil3.5	реле
jqx-14fc2as10aac6nil5	реле
jqx-14fc2as10adc120.83.5	реле
jqx-14fc2as10adc120.85	реле
jqx-14fc2as10adc121.23.5	реле
jqx-14fc2as10adc121.25	реле
jqx-14fc2as10adc1213.5	реле
jqx-14fc2as10adc1215	реле
jqx-14fc2as10adc12nil3.5	реле
jqx-14fc2as10adc12nil5	реле

jqx-14fc2as10adc240.83.5	реле
jqx-14fc2as10adc240.85	реле
jqx-14fc2as10adc241.23.5	реле
jqx-14fc2as10adc241.25	реле
jqx-14fc2as10adc2413.5	реле
jqx-14fc2as10adc2415	реле
jqx-14fc2as10adc24nil3.5	реле
jqx-14fc2as10adc24nil5	реле
jqx-14fc2as10adc60.83.5	реле
jqx-14fc2as10adc60.85	реле
jqx-14fc2as10adc61.23.5	реле
jqx-14fc2as10adc61.25	реле
jqx-14fc2as10adc613.5	реле
jqx-14fc2as10adc615	реле
jqx-14fc2as10adc6nil3.5	реле
jqx-14fc2as10adc6nil5	реле
jqx-14fc2as16	релес
jqx-14fc2as20	релес
jqx-14fc2as20aac120.83.5	реле
jqx-14fc2as20aac120.85	реле
jqx-14fc2as20aac121.23.5	реле
jqx-14fc2as20aac121.25	реле
jqx-14fc2as20aac1213.5	реле
jqx-14fc2as20aac1215	реле
jqx-14fc2as20aac12nil3.5	реле
jqx-14fc2as20aac12nil5	реле
jqx-14fc2as20aac240.83.5	реле
jqx-14fc2as20aac240.85	реле

jqx-14fc2as20aac241.23.5	реле
jqx-14fc2as20aac241.25	реле
jqx-14fc2as20aac2413.5	реле
jqx-14fc2as20aac2415	реле
jqx-14fc2as20aac24nil3.5	реле
jqx-14fc2as20aac24nil5	реле
jqx-14fc2as20aac60.83.5	реле
jqx-14fc2as20aac60.85	реле
jqx-14fc2as20aac61.23.5	реле
jqx-14fc2as20aac61.25	реле
jqx-14fc2as20aac613.5	реле
jqx-14fc2as20aac615	реле
jqx-14fc2as20aac6nil3.5	реле
jqx-14fc2as20aac6nil5	реле
jqx-14fc2as20adc120.83.5	реле
jqx-14fc2as20adc120.85	реле
jqx-14fc2as20adc121.23.5	реле
jqx-14fc2as20adc121.25	реле
jqx-14fc2as20adc1213.5	реле
jqx-14fc2as20adc1215	реле
jqx-14fc2as20adc12nil3.5	реле
jqx-14fc2as20adc12nil5	реле
jqx-14fc2as20adc240.83.5	реле
jqx-14fc2as20adc240.85	реле
jqx-14fc2as20adc241.23.5	реле
jqx-14fc2as20adc241.25	реле
jqx-14fc2as20adc2413.5	реле
jqx-14fc2as20adc2415	реле

jqx-14fc2as20adc24nil3.5 реле
jqx-14fc2as20adc24nil5 реле
jqx-14fc2as20adc60.83.5 реле
jqx-14fc2as20adc60.85 реле
jqx-14fc2as20adc61.23.5 реле
jqx-14fc2as20adc61.25 реле
jqx-14fc2as20adc613.5 реле
jqx-14fc2as20adc615 реле
jqx-14fc2as20adc6nil3.5 реле
jqx-14fc2as20adc6nil5 реле
jqx-14fc2as3 релес
jqx-14fc2as3aac120.83.5 реле
jqx-14fc2as3aac120.85 реле
jqx-14fc2as3aac121.23.5 реле
jqx-14fc2as3aac121.25 реле
jqx-14fc2as3aac1213.5 реле
jqx-14fc2as3aac1215 реле
jqx-14fc2as3aac12nil3.5 реле
jqx-14fc2as3aac12nil5 реле
jqx-14fc2as3aac240.83.5 реле
jqx-14fc2as3aac240.85 реле
jqx-14fc2as3aac241.23.5 реле
jqx-14fc2as3aac241.25 реле
jqx-14fc2as3aac2413.5 реле
jqx-14fc2as3aac2415 реле
jqx-14fc2as3aac24nil3.5 реле
jqx-14fc2as3aac24nil5 реле
jqx-14fc2as3aac60.83.5 реле

jqx-14fc2as3aac60.85 реле
jqx-14fc2as3aac61.23.5 реле
jqx-14fc2as3aac61.25 реле
jqx-14fc2as3aac613.5 реле
jqx-14fc2as3aac615 реле
jqx-14fc2as3aac6nil3.5 реле
jqx-14fc2as3aac6nil5 реле
jqx-14fc2as3adc120.83.5 реле
jqx-14fc2as3adc120.85 реле
jqx-14fc2as3adc121.23.5 реле
jqx-14fc2as3adc121.25 реле
jqx-14fc2as3adc1213.5 реле
jqx-14fc2as3adc1215 реле
jqx-14fc2as3adc12nil3.5 реле
jqx-14fc2as3adc12nil5 реле
jqx-14fc2as3adc240.83.5 реле
jqx-14fc2as3adc240.85 реле
jqx-14fc2as3adc241.23.5 реле
jqx-14fc2as3adc241.25 реле
jqx-14fc2as3adc2413.5 реле
jqx-14fc2as3adc2415 реле
jqx-14fc2as3adc24nil3.5 реле
jqx-14fc2as3adc24nil5 реле
jqx-14fc2as3adc60.83.5реле
jqx-14fc2as3adc60.85 реле
jqx-14fc2as3adc61.23.5реле
jqx-14fc2as3adc61.25 реле
jqx-14fc2as3adc613.5 реле

jqx-14fc2as3adc615 реле
jqx-14fc2as3adc6nil3.5 реле
jqx-14fc2as3adc6nil5 реле
jqx-14fc2as5 релес
jqx-14fc2as5aac120.83.5 реле
jqx-14fc2as5aac120.85 реле
jqx-14fc2as5aac121.23.5 реле
jqx-14fc2as5aac121.25 реле
jqx-14fc2as5aac1213.5 реле
jqx-14fc2as5aac1215 реле
jqx-14fc2as5aac12nil3.5 реле
jqx-14fc2as5aac12nil5 реле
jqx-14fc2as5aac240.83.5 реле
jqx-14fc2as5aac240.85 реле
jqx-14fc2as5aac241.23.5 реле
jqx-14fc2as5aac241.25 реле
jqx-14fc2as5aac2413.5 реле
jqx-14fc2as5aac2415 реле
jqx-14fc2as5aac24nil3.5 реле
jqx-14fc2as5aac24nil5 реле
jqx-14fc2as5aac60.83.5 реле
jqx-14fc2as5aac60.85 реле
jqx-14fc2as5aac61.23.5 реле
jqx-14fc2as5aac61.25 реле
jqx-14fc2as5aac613.5 реле
jqx-14fc2as5aac615 реле
jqx-14fc2as5aac6nil3.5 реле
jqx-14fc2as5aac6nil5 реле

jqx-14fc2as5adc120.83.5 реле
jqx-14fc2as5adc120.85 реле
jqx-14fc2as5adc121.23.5 реле
jqx-14fc2as5adc121.25 реле
jqx-14fc2as5adc1213.5 реле
jqx-14fc2as5adc1215 реле
jqx-14fc2as5adc12nil3.5 реле
jqx-14fc2as5adc12nil5 реле
jqx-14fc2as5adc240.83.5 реле
jqx-14fc2as5adc240.85 реле
jqx-14fc2as5adc241.23.5 реле
jqx-14fc2as5adc241.25 реле
jqx-14fc2as5adc2413.5 реле
jqx-14fc2as5adc2415 реле
jqx-14fc2as5adc24nil3.5 реле
jqx-14fc2as5adc24nil5 реле
jqx-14fc2as5adc60.83.5реле
jqx-14fc2as5adc60.85 реле
jqx-14fc2as5adc61.23.5реле
jqx-14fc2as5adc61.25 реле
jqx-14fc2as5adc613.5 реле
jqx-14fc2as5adc615 реле
jqx-14fc2as5adc6nil3.5 реле
jqx-14fc2as5adc6nil5 реле
jqx-14fc2as6 релес
jqx-14fc2as6aac120.83.5 реле
jqx-14fc2as6aac120.85 реле
jqx-14fc2as6aac121.23.5 реле

jqx-14fc2as6aac121.25 реле
jqx-14fc2as6aac1213.5 реле
jqx-14fc2as6aac1215 реле
jqx-14fc2as6aac12nil3.5 реле
jqx-14fc2as6aac12nil5 реле
jqx-14fc2as6aac240.83.5 реле
jqx-14fc2as6aac240.85 реле
jqx-14fc2as6aac241.23.5 реле
jqx-14fc2as6aac241.25 реле
jqx-14fc2as6aac2413.5 реле
jqx-14fc2as6aac2415 реле
jqx-14fc2as6aac24nil3.5 реле
jqx-14fc2as6aac24nil5 реле
jqx-14fc2as6aac60.83.5 реле
jqx-14fc2as6aac60.85 реле
jqx-14fc2as6aac61.23.5 реле
jqx-14fc2as6aac61.25 реле
jqx-14fc2as6aac613.5 реле
jqx-14fc2as6aac615 реле
jqx-14fc2as6aac6nil3.5 реле
jqx-14fc2as6aac6nil5 реле
jqx-14fc2as6adc120.83.5 реле
jqx-14fc2as6adc120.85 реле
jqx-14fc2as6adc121.23.5 реле
jqx-14fc2as6adc121.25 реле
jqx-14fc2as6adc1213.5 реле
jqx-14fc2as6adc1215 реле
jqx-14fc2as6adc12nil3.5 реле

jqx-14fc2as6adc12nil5 реле
jqx-14fc2as6adc240.83.5 реле
jqx-14fc2as6adc240.85 реле
jqx-14fc2as6adc241.23.5 реле
jqx-14fc2as6adc241.25 реле
jqx-14fc2as6adc2413.5 реле
jqx-14fc2as6adc2415 реле
jqx-14fc2as6adc24nil3.5 реле
jqx-14fc2as6adc24nil5 реле
jqx-14fc2as6adc60.83.5реле
jqx-14fc2as6adc60.85 реле
jqx-14fc2as6adc61.23.5реле
jqx-14fc2as6adc61.25 реле
jqx-14fc2as6adc613.5 реле
jqx-14fc2as6adc615 реле
jqx-14fc2as6adc6nil3.5 реле
jqx-14fc2as6adc6nil5 реле
jqx-14fc2as8 релес
jqx-14fc2az10 релес
jqx-14fc2az10aac120.83.5 реле
jqx-14fc2az10aac120.85 реле
jqx-14fc2az10aac121.23.5 реле
jqx-14fc2az10aac121.25 реле
jqx-14fc2az10aac1213.5 реле
jqx-14fc2az10aac1215 реле
jqx-14fc2az10aac12nil3.5 реле
jqx-14fc2az10aac12nil5 реле
jqx-14fc2az10aac240.83.5 реле

jqx-14fc2az10aac240.85	реле
jqx-14fc2az10aac241.23.5	реле
jqx-14fc2az10aac241.25	реле
jqx-14fc2az10aac2413.5	реле
jqx-14fc2az10aac2415	реле
jqx-14fc2az10aac24nil3.5	реле
jqx-14fc2az10aac24nil5	реле
jqx-14fc2az10aac60.83.5	реле
jqx-14fc2az10aac60.85	реле
jqx-14fc2az10aac61.23.5	реле
jqx-14fc2az10aac61.25	реле
jqx-14fc2az10aac613.5	реле
jqx-14fc2az10aac615	реле
jqx-14fc2az10aac6nil3.5	реле
jqx-14fc2az10aac6nil5	реле
jqx-14fc2az10adc120.83.5	реле
jqx-14fc2az10adc120.85	реле
jqx-14fc2az10adc121.23.5	реле
jqx-14fc2az10adc121.25	реле
jqx-14fc2az10adc1213.5	реле
jqx-14fc2az10adc1215	реле
jqx-14fc2az10adc12nil3.5	реле
jqx-14fc2az10adc12nil5	реле
jqx-14fc2az10adc240.83.5	реле
jqx-14fc2az10adc240.85	реле
jqx-14fc2az10adc241.23.5	реле
jqx-14fc2az10adc241.25	реле
jqx-14fc2az10adc2413.5	реле

jqx-14fc2az10adc2415 реле
jqx-14fc2az10adc24nil3.5 реле
jqx-14fc2az10adc24nil5 реле
jqx-14fc2az10adc60.83.5 реле
jqx-14fc2az10adc60.85 реле
jqx-14fc2az10adc61.23.5 реле
jqx-14fc2az10adc61.25 реле
jqx-14fc2az10adc613.5 реле
jqx-14fc2az10adc615 реле
jqx-14fc2az10adc6nil3.5 реле
jqx-14fc2az10adc6nil5 реле
jqx-14fc2az16 релес
jqx-14fc2az20 релес
jqx-14fc2az20aac120.83.5 реле
jqx-14fc2az20aac120.85 реле
jqx-14fc2az20aac121.23.5 реле
jqx-14fc2az20aac121.25 реле
jqx-14fc2az20aac1213.5 реле
jqx-14fc2az20aac1215 реле
jqx-14fc2az20aac12nil3.5 реле
jqx-14fc2az20aac12nil5 реле
jqx-14fc2az20aac240.83.5 реле
jqx-14fc2az20aac240.85 реле
jqx-14fc2az20aac241.23.5 реле
jqx-14fc2az20aac241.25 реле
jqx-14fc2az20aac2413.5 реле
jqx-14fc2az20aac2415 реле
jqx-14fc2az20aac24nil3.5 реле

jqx-14fc2az20aac24nil5 реле
jqx-14fc2az20aac60.83.5 реле
jqx-14fc2az20aac60.85 реле
jqx-14fc2az20aac61.23.5 реле
jqx-14fc2az20aac61.25 реле
jqx-14fc2az20aac613.5 реле
jqx-14fc2az20aac615 реле
jqx-14fc2az20aac6nil3.5 реле
jqx-14fc2az20aac6nil5 реле
jqx-14fc2az20adc120.83.5 реле
jqx-14fc2az20adc120.85 реле
jqx-14fc2az20adc121.23.5 реле
jqx-14fc2az20adc121.25 реле
jqx-14fc2az20adc1213.5 реле
jqx-14fc2az20adc1215 реле
jqx-14fc2az20adc12nil3.5 реле
jqx-14fc2az20adc12nil5 реле
jqx-14fc2az20adc240.83.5 реле
jqx-14fc2az20adc240.85 реле
jqx-14fc2az20adc241.23.5 реле
jqx-14fc2az20adc241.25 реле
jqx-14fc2az20adc2413.5 реле
jqx-14fc2az20adc2415 реле
jqx-14fc2az20adc24nil3.5 реле
jqx-14fc2az20adc24nil5 реле
jqx-14fc2az20adc60.83.5 реле
jqx-14fc2az20adc60.85 реле
jqx-14fc2az20adc61.23.5 реле

jqx-14fc2az20adc61.25 реле
jqx-14fc2az20adc613.5 реле
jqx-14fc2az20adc615 реле
jqx-14fc2az20adc6nil3.5 реле
jqx-14fc2az20adc6nil5 реле
jqx-14fc2az3 релес
jqx-14fc2az3aac120.83.5 реле
jqx-14fc2az3aac120.85 реле
jqx-14fc2az3aac121.23.5 реле
jqx-14fc2az3aac121.25 реле
jqx-14fc2az3aac1213.5 реле
jqx-14fc2az3aac1215 реле
jqx-14fc2az3aac12nil3.5 реле
jqx-14fc2az3aac12nil5 реле
jqx-14fc2az3aac240.83.5 реле
jqx-14fc2az3aac240.85 реле
jqx-14fc2az3aac241.23.5 реле
jqx-14fc2az3aac241.25 реле
jqx-14fc2az3aac2413.5 реле
jqx-14fc2az3aac2415 реле
jqx-14fc2az3aac24nil3.5 реле
jqx-14fc2az3aac24nil5 реле
jqx-14fc2az3aac60.83.5 реле
jqx-14fc2az3aac60.85 реле
jqx-14fc2az3aac61.23.5 реле
jqx-14fc2az3aac61.25 реле
jqx-14fc2az3aac613.5 реле
jqx-14fc2az3aac615 реле

jqx-14fc2az3aac6nil3.5 реле
jqx-14fc2az3aac6nil5 реле
jqx-14fc2az3adc120.83.5 реле
jqx-14fc2az3adc120.85 реле
jqx-14fc2az3adc121.23.5 реле
jqx-14fc2az3adc121.25 реле
jqx-14fc2az3adc1213.5 реле
jqx-14fc2az3adc1215 реле
jqx-14fc2az3adc12nil3.5 реле
jqx-14fc2az3adc12nil5 реле
jqx-14fc2az3adc240.83.5 реле
jqx-14fc2az3adc240.85 реле
jqx-14fc2az3adc241.23.5 реле
jqx-14fc2az3adc241.25 реле
jqx-14fc2az3adc2413.5 реле
jqx-14fc2az3adc2415 реле
jqx-14fc2az3adc24nil3.5 реле
jqx-14fc2az3adc24nil5 реле
jqx-14fc2az3adc60.83.5реле
jqx-14fc2az3adc60.85 реле
jqx-14fc2az3adc61.23.5реле
jqx-14fc2az3adc61.25 реле
jqx-14fc2az3adc613.5 реле
jqx-14fc2az3adc615 реле
jqx-14fc2az3adc6nil3.5 реле
jqx-14fc2az3adc6nil5 реле
jqx-14fc2az5 релес
jqx-14fc2az5aac120.83.5 реле

jqx-14fc2az5aac120.85 реле
jqx-14fc2az5aac121.23.5 реле
jqx-14fc2az5aac121.25 реле
jqx-14fc2az5aac1213.5 реле
jqx-14fc2az5aac1215 реле
jqx-14fc2az5aac12nil3.5 реле
jqx-14fc2az5aac12nil5 реле
jqx-14fc2az5aac240.83.5 реле
jqx-14fc2az5aac240.85 реле
jqx-14fc2az5aac241.23.5 реле
jqx-14fc2az5aac241.25 реле
jqx-14fc2az5aac2413.5 реле
jqx-14fc2az5aac2415 реле
jqx-14fc2az5aac24nil3.5 реле
jqx-14fc2az5aac24nil5 реле
jqx-14fc2az5aac60.83.5 реле
jqx-14fc2az5aac60.85 реле
jqx-14fc2az5aac61.23.5 реле
jqx-14fc2az5aac61.25 реле
jqx-14fc2az5aac613.5 реле
jqx-14fc2az5aac615 реле
jqx-14fc2az5aac6nil3.5 реле
jqx-14fc2az5aac6nil5 реле
jqx-14fc2az5adc120.83.5 реле
jqx-14fc2az5adc120.85 реле
jqx-14fc2az5adc121.23.5 реле
jqx-14fc2az5adc121.25 реле
jqx-14fc2az5adc1213.5 реле

jqx-14fc2az5adc1215 реле
jqx-14fc2az5adc12nil3.5 реле
jqx-14fc2az5adc12nil5 реле
jqx-14fc2az5adc240.83.5 реле
jqx-14fc2az5adc240.85 реле
jqx-14fc2az5adc241.23.5 реле
jqx-14fc2az5adc241.25 реле
jqx-14fc2az5adc2413.5 реле
jqx-14fc2az5adc2415 реле
jqx-14fc2az5adc24nil3.5 реле
jqx-14fc2az5adc24nil5 реле
jqx-14fc2az5adc60.83.5реле
jqx-14fc2az5adc60.85 реле
jqx-14fc2az5adc61.23.5реле
jqx-14fc2az5adc61.25 реле
jqx-14fc2az5adc613.5 реле
jqx-14fc2az5adc615 реле
jqx-14fc2az5adc6nil3.5 реле
jqx-14fc2az5adc6nil5 реле
jqx-14fc2az6 релес
jqx-14fc2az6aac120.83.5 реле
jqx-14fc2az6aac120.85 реле
jqx-14fc2az6aac121.23.5 реле
jqx-14fc2az6aac121.25 реле
jqx-14fc2az6aac1213.5 реле
jqx-14fc2az6aac1215 реле
jqx-14fc2az6aac12nil3.5 реле
jqx-14fc2az6aac12nil5 реле

jqx-14fc2az6aac240.83.5 реле
jqx-14fc2az6aac240.85 реле
jqx-14fc2az6aac241.23.5 реле
jqx-14fc2az6aac241.25 реле
jqx-14fc2az6aac2413.5 реле
jqx-14fc2az6aac2415 реле
jqx-14fc2az6aac24nil3.5 реле
jqx-14fc2az6aac24nil5 реле
jqx-14fc2az6aac60.83.5 реле
jqx-14fc2az6aac60.85 реле
jqx-14fc2az6aac61.23.5 реле
jqx-14fc2az6aac61.25 реле
jqx-14fc2az6aac613.5 реле
jqx-14fc2az6aac615 реле
jqx-14fc2az6aac6nil3.5 реле
jqx-14fc2az6aac6nil5 реле
jqx-14fc2az6adc120.83.5 реле
jqx-14fc2az6adc120.85 реле
jqx-14fc2az6adc121.23.5 реле
jqx-14fc2az6adc121.25 реле
jqx-14fc2az6adc1213.5 реле
jqx-14fc2az6adc1215 реле
jqx-14fc2az6adc12nil3.5 реле
jqx-14fc2az6adc12nil5 реле
jqx-14fc2az6adc240.83.5 реле
jqx-14fc2az6adc240.85 реле
jqx-14fc2az6adc241.23.5 реле
jqx-14fc2az6adc241.25 реле

jqx-14fc2az6adc2413.5 реле
jqx-14fc2az6adc2415 реле
jqx-14fc2az6adc24nil3.5 реле
jqx-14fc2az6adc24nil5 реле
jqx-14fc2az6adc60.83.5реле
jqx-14fc2az6adc60.85 реле
jqx-14fc2az6adc61.23.5реле
jqx-14fc2az6adc61.25 реле
jqx-14fc2az6adc613.5 реле
jqx-14fc2az6adc615 реле
jqx-14fc2az6adc6nil3.5 реле
jqx-14fc2az6adc6nil5 реле
jqx-14fc2az8 релес
jqx-14fc2cs10 релес
jqx-14fc2cs10аас120.83.5 реле
jqx-14fc2cs10аас120.85 реле
jqx-14fc2cs10аас121.23.5 реле
jqx-14fc2cs10аас121.25 реле
jqx-14fc2cs10аас1213.5 реле
jqx-14fc2cs10аас1215 реле
jqx-14fc2cs10аас12nil3.5 реле
jqx-14fc2cs10аас12nil5 реле
jqx-14fc2cs10аас240.83.5 реле
jqx-14fc2cs10аас240.85 реле
jqx-14fc2cs10аас241.23.5 реле
jqx-14fc2cs10аас241.25 реле
jqx-14fc2cs10аас2413.5 реле
jqx-14fc2cs10аас2415 реле

jqx-14fc2cs10aac24nil3.5	реле
jqx-14fc2cs10aac24nil5	реле
jqx-14fc2cs10aac60.83.5	реле
jqx-14fc2cs10aac60.85	реле
jqx-14fc2cs10aac61.23.5	реле
jqx-14fc2cs10aac61.25	реле
jqx-14fc2cs10aac613.5	реле
jqx-14fc2cs10aac615	реле
jqx-14fc2cs10aac6nil3.5	реле
jqx-14fc2cs10aac6nil5	реле
jqx-14fc2cs10adc120.83.5	реле
jqx-14fc2cs10adc120.85	реле
jqx-14fc2cs10adc121.23.5	реле
jqx-14fc2cs10adc121.25	реле
jqx-14fc2cs10adc1213.5	реле
jqx-14fc2cs10adc1215	реле
jqx-14fc2cs10adc12nil3.5	реле
jqx-14fc2cs10adc12nil5	реле
jqx-14fc2cs10adc240.83.5	реле
jqx-14fc2cs10adc240.85	реле
jqx-14fc2cs10adc241.23.5	реле
jqx-14fc2cs10adc241.25	реле
jqx-14fc2cs10adc2413.5	реле
jqx-14fc2cs10adc2415	реле
jqx-14fc2cs10adc24nil3.5	реле
jqx-14fc2cs10adc24nil5	реле
jqx-14fc2cs10adc60.83.5	реле
jqx-14fc2cs10adc60.85	реле

jqx-14fc2cs10adc61.23.5 реле
jqx-14fc2cs10adc61.25 реле
jqx-14fc2cs10adc613.5 реле
jqx-14fc2cs10adc615 реле
jqx-14fc2cs10adc6nil3.5 реле
jqx-14fc2cs10adc6nil5 реле
jqx-14fc2cs16 релес
jqx-14fc2cs20 релес
jqx-14fc2cs20aac120.83.5 реле
jqx-14fc2cs20aac120.85 реле
jqx-14fc2cs20aac121.23.5 реле
jqx-14fc2cs20aac121.25 реле
jqx-14fc2cs20aac1213.5 реле
jqx-14fc2cs20aac1215 реле
jqx-14fc2cs20aac12nil3.5 реле
jqx-14fc2cs20aac12nil5 реле
jqx-14fc2cs20aac240.83.5 реле
jqx-14fc2cs20aac240.85 реле
jqx-14fc2cs20aac241.23.5 реле
jqx-14fc2cs20aac241.25 реле
jqx-14fc2cs20aac2413.5 реле
jqx-14fc2cs20aac2415 реле
jqx-14fc2cs20aac24nil3.5 реле
jqx-14fc2cs20aac24nil5 реле
jqx-14fc2cs20aac60.83.5 реле
jqx-14fc2cs20aac60.85 реле
jqx-14fc2cs20aac61.23.5 реле
jqx-14fc2cs20aac61.25 реле

jqx-14fc2cs20aac613.5 реле
jqx-14fc2cs20aac615 реле
jqx-14fc2cs20aac6nil3.5 реле
jqx-14fc2cs20aac6nil5 реле
jqx-14fc2cs20adc120.83.5 реле
jqx-14fc2cs20adc120.85 реле
jqx-14fc2cs20adc121.23.5 реле
jqx-14fc2cs20adc121.25 реле
jqx-14fc2cs20adc1213.5 реле
jqx-14fc2cs20adc1215 реле
jqx-14fc2cs20adc12nil3.5 реле
jqx-14fc2cs20adc12nil5 реле
jqx-14fc2cs20adc240.83.5 реле
jqx-14fc2cs20adc240.85 реле
jqx-14fc2cs20adc241.23.5 реле
jqx-14fc2cs20adc241.25 реле
jqx-14fc2cs20adc2413.5 реле
jqx-14fc2cs20adc2415 реле
jqx-14fc2cs20adc24nil3.5 реле
jqx-14fc2cs20adc24nil5 реле
jqx-14fc2cs20adc60.83.5 реле
jqx-14fc2cs20adc60.85 реле
jqx-14fc2cs20adc61.23.5 реле
jqx-14fc2cs20adc61.25 реле
jqx-14fc2cs20adc613.5 реле
jqx-14fc2cs20adc615 реле
jqx-14fc2cs20adc6nil3.5 реле
jqx-14fc2cs20adc6nil5 реле

jqx-14fc2cs3 релес
jqx-14fc2cs3aac120.83.5 реле
jqx-14fc2cs3aac120.85 реле
jqx-14fc2cs3aac121.23.5 реле
jqx-14fc2cs3aac121.25 реле
jqx-14fc2cs3aac1213.5 реле
jqx-14fc2cs3aac1215 реле
jqx-14fc2cs3aac12nil3.5 реле
jqx-14fc2cs3aac12nil5 реле
jqx-14fc2cs3aac240.83.5 реле
jqx-14fc2cs3aac240.85 реле
jqx-14fc2cs3aac241.23.5 реле
jqx-14fc2cs3aac241.25 реле
jqx-14fc2cs3aac2413.5 реле
jqx-14fc2cs3aac2415 реле
jqx-14fc2cs3aac24nil3.5 реле
jqx-14fc2cs3aac24nil5 реле
jqx-14fc2cs3aac60.83.5 реле
jqx-14fc2cs3aac60.85 реле
jqx-14fc2cs3aac61.23.5 реле
jqx-14fc2cs3aac61.25 реле
jqx-14fc2cs3aac613.5 реле
jqx-14fc2cs3aac615 реле
jqx-14fc2cs3aac6nil3.5 реле
jqx-14fc2cs3aac6nil5 реле
jqx-14fc2cs3adc120.83.5 реле
jqx-14fc2cs3adc120.85 реле
jqx-14fc2cs3adc121.23.5 реле

jqx-14fc2cs3adc121.25 реле
jqx-14fc2cs3adc1213.5 реле
jqx-14fc2cs3adc1215 реле
jqx-14fc2cs3adc12nil3.5 реле
jqx-14fc2cs3adc12nil5 реле
jqx-14fc2cs3adc240.83.5 реле
jqx-14fc2cs3adc240.85 реле
jqx-14fc2cs3adc241.23.5 реле
jqx-14fc2cs3adc241.25 реле
jqx-14fc2cs3adc2413.5 реле
jqx-14fc2cs3adc2415 реле
jqx-14fc2cs3adc24nil3.5 реле
jqx-14fc2cs3adc24nil5 реле
jqx-14fc2cs3adc60.83.5 реле
jqx-14fc2cs3adc60.85 реле
jqx-14fc2cs3adc61.23.5 реле
jqx-14fc2cs3adc61.25 реле
jqx-14fc2cs3adc613.5 реле
jqx-14fc2cs3adc615 реле
jqx-14fc2cs3adc6nil3.5 реле
jqx-14fc2cs3adc6nil5 реле
jqx-14fc2cs5 релес
jqx-14fc2cs5aac120.83.5 реле
jqx-14fc2cs5aac120.85 реле
jqx-14fc2cs5aac121.23.5 реле
jqx-14fc2cs5aac121.25 реле
jqx-14fc2cs5aac1213.5 реле
jqx-14fc2cs5aac1215 реле

jqx-14fc2cs5aac12nil3.5 реле
jqx-14fc2cs5aac12nil5 реле
jqx-14fc2cs5aac240.83.5 реле
jqx-14fc2cs5aac240.85 реле
jqx-14fc2cs5aac241.23.5 реле
jqx-14fc2cs5aac241.25 реле
jqx-14fc2cs5aac2413.5 реле
jqx-14fc2cs5aac2415 реле
jqx-14fc2cs5aac24nil3.5 реле
jqx-14fc2cs5aac24nil5 реле
jqx-14fc2cs5aac60.83.5 реле
jqx-14fc2cs5aac60.85 реле
jqx-14fc2cs5aac61.23.5 реле
jqx-14fc2cs5aac61.25 реле
jqx-14fc2cs5aac613.5 реле
jqx-14fc2cs5aac615 реле
jqx-14fc2cs5aac6nil3.5 реле
jqx-14fc2cs5aac6nil5 реле
jqx-14fc2cs5adc120.83.5 реле
jqx-14fc2cs5adc120.85 реле
jqx-14fc2cs5adc121.23.5 реле
jqx-14fc2cs5adc121.25 реле
jqx-14fc2cs5adc1213.5 реле
jqx-14fc2cs5adc1215 реле
jqx-14fc2cs5adc12nil3.5 реле
jqx-14fc2cs5adc12nil5 реле
jqx-14fc2cs5adc240.83.5 реле
jqx-14fc2cs5adc240.85 реле

jqx-14fc2cs5adc241.23.5 реле
jqx-14fc2cs5adc241.25 реле
jqx-14fc2cs5adc2413.5 реле
jqx-14fc2cs5adc2415 реле
jqx-14fc2cs5adc24nil3.5 реле
jqx-14fc2cs5adc24nil5 реле
jqx-14fc2cs5adc60.83.5 реле
jqx-14fc2cs5adc60.85 реле
jqx-14fc2cs5adc61.23.5 реле
jqx-14fc2cs5adc61.25 реле
jqx-14fc2cs5adc613.5 реле
jqx-14fc2cs5adc615 реле
jqx-14fc2cs5adc6nil3.5 реле
jqx-14fc2cs5adc6nil5 реле
jqx-14fc2cs6 релес
jqx-14fc2cs6aac120.83.5 реле
jqx-14fc2cs6aac120.85 реле
jqx-14fc2cs6aac121.23.5 реле
jqx-14fc2cs6aac121.25 реле
jqx-14fc2cs6aac1213.5 реле
jqx-14fc2cs6aac1215 реле
jqx-14fc2cs6aac12nil3.5 реле
jqx-14fc2cs6aac12nil5 реле
jqx-14fc2cs6aac240.83.5 реле
jqx-14fc2cs6aac240.85 реле
jqx-14fc2cs6aac241.23.5 реле
jqx-14fc2cs6aac241.25 реле
jqx-14fc2cs6aac2413.5 реле

jqx-14fc2cs6aac2415 реле
jqx-14fc2cs6aac24nil3.5 реле
jqx-14fc2cs6aac24nil5 реле
jqx-14fc2cs6aac60.83.5 реле
jqx-14fc2cs6aac60.85 реле
jqx-14fc2cs6aac61.23.5 реле
jqx-14fc2cs6aac61.25 реле
jqx-14fc2cs6aac613.5 реле
jqx-14fc2cs6aac615 реле
jqx-14fc2cs6aac6nil3.5 реле
jqx-14fc2cs6aac6nil5 реле
jqx-14fc2cs6adc120.83.5 реле
jqx-14fc2cs6adc120.85 реле
jqx-14fc2cs6adc121.23.5 реле
jqx-14fc2cs6adc121.25 реле
jqx-14fc2cs6adc1213.5 реле
jqx-14fc2cs6adc1215 реле
jqx-14fc2cs6adc12nil3.5 реле
jqx-14fc2cs6adc12nil5 реле
jqx-14fc2cs6adc240.83.5 реле
jqx-14fc2cs6adc240.85 реле
jqx-14fc2cs6adc241.23.5 реле
jqx-14fc2cs6adc241.25 реле
jqx-14fc2cs6adc2413.5 реле
jqx-14fc2cs6adc2415 реле
jqx-14fc2cs6adc24nil3.5 реле
jqx-14fc2cs6adc24nil5 реле
jqx-14fc2cs6adc60.83.5 реле

jqx-14fc2cs6adc60.85 реле
jqx-14fc2cs6adc61.23.5 реле
jqx-14fc2cs6adc61.25 реле
jqx-14fc2cs6adc613.5 реле
jqx-14fc2cs6adc615 реле
jqx-14fc2cs6adc6nil3.5 реле
jqx-14fc2cs6adc6nil5 реле
jqx-14fc2cs8 релес
jqx-14fc2cz10 релес
jqx-14fc2cz10aac120.83.5 реле
jqx-14fc2cz10aac120.85 реле
jqx-14fc2cz10aac121.23.5 реле
jqx-14fc2cz10aac121.25 реле
jqx-14fc2cz10aac1213.5 реле
jqx-14fc2cz10aac1215 реле
jqx-14fc2cz10aac12nil3.5 реле
jqx-14fc2cz10aac12nil5 реле
jqx-14fc2cz10aac240.83.5 реле
jqx-14fc2cz10aac240.85 реле
jqx-14fc2cz10aac241.23.5 реле
jqx-14fc2cz10aac241.25 реле
jqx-14fc2cz10aac2413.5 реле
jqx-14fc2cz10aac2415 реле
jqx-14fc2cz10aac24nil3.5 реле
jqx-14fc2cz10aac24nil5 реле
jqx-14fc2cz10aac60.83.5 реле
jqx-14fc2cz10aac60.85 реле
jqx-14fc2cz10aac61.23.5 реле

jqx-14fc2cz10aac61.25 реле
jqx-14fc2cz10aac613.5 реле
jqx-14fc2cz10aac615 реле
jqx-14fc2cz10aac6nil3.5 реле
jqx-14fc2cz10aac6nil5 реле
jqx-14fc2cz10adc120.83.5 реле
jqx-14fc2cz10adc120.85 реле
jqx-14fc2cz10adc121.23.5 реле
jqx-14fc2cz10adc121.25 реле
jqx-14fc2cz10adc1213.5 реле
jqx-14fc2cz10adc1215 реле
jqx-14fc2cz10adc12nil3.5 реле
jqx-14fc2cz10adc12nil5 реле
jqx-14fc2cz10adc240.83.5 реле
jqx-14fc2cz10adc240.85 реле
jqx-14fc2cz10adc241.23.5 реле
jqx-14fc2cz10adc241.25 реле
jqx-14fc2cz10adc2413.5 реле
jqx-14fc2cz10adc2415 реле
jqx-14fc2cz10adc24nil3.5 реле
jqx-14fc2cz10adc24nil5 реле
jqx-14fc2cz10adc60.83.5 реле
jqx-14fc2cz10adc60.85 реле
jqx-14fc2cz10adc61.23.5 реле
jqx-14fc2cz10adc61.25 реле
jqx-14fc2cz10adc613.5 реле
jqx-14fc2cz10adc615 реле
jqx-14fc2cz10adc6nil3.5 реле

jqx-14fc2cz10adc6nil5 реле
jqx-14fc2cz16 релес
jqx-14fc2cz20 релес
jqx-14fc2cz20aac120.83.5 реле
jqx-14fc2cz20aac120.85 реле
jqx-14fc2cz20aac121.23.5 реле
jqx-14fc2cz20aac121.25 реле
jqx-14fc2cz20aac1213.5 реле
jqx-14fc2cz20aac1215 реле
jqx-14fc2cz20aac12nil3.5 реле
jqx-14fc2cz20aac12nil5 реле
jqx-14fc2cz20aac240.83.5 реле
jqx-14fc2cz20aac240.85 реле
jqx-14fc2cz20aac241.23.5 реле
jqx-14fc2cz20aac241.25 реле
jqx-14fc2cz20aac2413.5 реле
jqx-14fc2cz20aac2415 реле
jqx-14fc2cz20aac24nil3.5 реле
jqx-14fc2cz20aac24nil5 реле
jqx-14fc2cz20aac60.83.5 реле
jqx-14fc2cz20aac60.85 реле
jqx-14fc2cz20aac61.23.5 реле
jqx-14fc2cz20aac61.25 реле
jqx-14fc2cz20aac613.5 реле
jqx-14fc2cz20aac615 реле
jqx-14fc2cz20aac6nil3.5 реле
jqx-14fc2cz20aac6nil5 реле
jqx-14fc2cz20adc120.83.5 реле

jqx-14fc2cz20adc120.85	реле
jqx-14fc2cz20adc121.23.5	реле
jqx-14fc2cz20adc121.25	реле
jqx-14fc2cz20adc1213.5	реле
jqx-14fc2cz20adc1215	реле
jqx-14fc2cz20adc12nil3.5	реле
jqx-14fc2cz20adc12nil5	реле
jqx-14fc2cz20adc240.83.5	реле
jqx-14fc2cz20adc240.85	реле
jqx-14fc2cz20adc241.23.5	реле
jqx-14fc2cz20adc241.25	реле
jqx-14fc2cz20adc2413.5	реле
jqx-14fc2cz20adc2415	реле
jqx-14fc2cz20adc24nil3.5	реле
jqx-14fc2cz20adc24nil5	реле
jqx-14fc2cz20adc60.83.5	реле
jqx-14fc2cz20adc60.85	реле
jqx-14fc2cz20adc61.23.5	реле
jqx-14fc2cz20adc61.25	реле
jqx-14fc2cz20adc613.5	реле
jqx-14fc2cz20adc615	реле
jqx-14fc2cz20adc6nil3.5	реле
jqx-14fc2cz20adc6nil5	реле
jqx-14fc2cz3	релес
jqx-14fc2cz3aac120.83.5	реле
jqx-14fc2cz3aac120.85	реле
jqx-14fc2cz3aac121.23.5	реле
jqx-14fc2cz3aac121.25	реле

jqx-14fc2cz3aac1213.5 реле
jqx-14fc2cz3aac1215 реле
jqx-14fc2cz3aac12nil3.5 реле
jqx-14fc2cz3aac12nil5 реле
jqx-14fc2cz3aac240.83.5 реле
jqx-14fc2cz3aac240.85 реле
jqx-14fc2cz3aac241.23.5 реле
jqx-14fc2cz3aac241.25 реле
jqx-14fc2cz3aac2413.5 реле
jqx-14fc2cz3aac2415 реле
jqx-14fc2cz3aac24nil3.5 реле
jqx-14fc2cz3aac24nil5 реле
jqx-14fc2cz3aac60.83.5 реле
jqx-14fc2cz3aac60.85 реле
jqx-14fc2cz3aac61.23.5 реле
jqx-14fc2cz3aac61.25 реле
jqx-14fc2cz3aac613.5 реле
jqx-14fc2cz3aac615 реле
jqx-14fc2cz3aac6nil3.5 реле
jqx-14fc2cz3aac6nil5 реле
jqx-14fc2cz3adc120.83.5 реле
jqx-14fc2cz3adc120.85 реле
jqx-14fc2cz3adc121.23.5 реле
jqx-14fc2cz3adc121.25 реле
jqx-14fc2cz3adc1213.5 реле
jqx-14fc2cz3adc1215 реле
jqx-14fc2cz3adc12nil3.5 реле
jqx-14fc2cz3adc12nil5 реле

jqx-14fc2cz3adc240.83.5 реле
jqx-14fc2cz3adc240.85 реле
jqx-14fc2cz3adc241.23.5 реле
jqx-14fc2cz3adc241.25 реле
jqx-14fc2cz3adc2413.5 реле
jqx-14fc2cz3adc2415 реле
jqx-14fc2cz3adc24nil3.5 реле
jqx-14fc2cz3adc24nil5 реле
jqx-14fc2cz3adc60.83.5 реле
jqx-14fc2cz3adc60.85 реле
jqx-14fc2cz3adc61.23.5 реле
jqx-14fc2cz3adc61.25 реле
jqx-14fc2cz3adc613.5 реле
jqx-14fc2cz3adc615 реле
jqx-14fc2cz3adc6nil3.5 реле
jqx-14fc2cz3adc6nil5 реле
jqx-14fc2cz5 релес
jqx-14fc2cz5aac120.83.5 реле
jqx-14fc2cz5aac120.85 реле
jqx-14fc2cz5aac121.23.5 реле
jqx-14fc2cz5aac121.25 реле
jqx-14fc2cz5aac1213.5 реле
jqx-14fc2cz5aac1215 реле
jqx-14fc2cz5aac12nil3.5 реле
jqx-14fc2cz5aac12nil5 реле
jqx-14fc2cz5aac240.83.5 реле
jqx-14fc2cz5aac240.85 реле
jqx-14fc2cz5aac241.23.5 реле

jqx-14fc2cz5aac241.25 реле
jqx-14fc2cz5aac2413.5 реле
jqx-14fc2cz5aac2415 реле
jqx-14fc2cz5aac24nil3.5 реле
jqx-14fc2cz5aac24nil5 реле
jqx-14fc2cz5aac60.83.5 реле
jqx-14fc2cz5aac60.85 реле
jqx-14fc2cz5aac61.23.5 реле
jqx-14fc2cz5aac61.25 реле
jqx-14fc2cz5aac613.5 реле
jqx-14fc2cz5aac615 реле
jqx-14fc2cz5aac6nil3.5 реле
jqx-14fc2cz5aac6nil5 реле
jqx-14fc2cz5adc120.83.5 реле
jqx-14fc2cz5adc120.85 реле
jqx-14fc2cz5adc121.23.5 реле
jqx-14fc2cz5adc121.25 реле
jqx-14fc2cz5adc1213.5 реле
jqx-14fc2cz5adc1215 реле
jqx-14fc2cz5adc12nil3.5 реле
jqx-14fc2cz5adc12nil5 реле
jqx-14fc2cz5adc240.83.5 реле
jqx-14fc2cz5adc240.85 реле
jqx-14fc2cz5adc241.23.5 реле
jqx-14fc2cz5adc241.25 реле
jqx-14fc2cz5adc2413.5 реле
jqx-14fc2cz5adc2415 реле
jqx-14fc2cz5adc24nil3.5 реле

jqx-14fc2cz5adc24nil5 реле
jqx-14fc2cz5adc60.83.5 реле
jqx-14fc2cz5adc60.85 реле
jqx-14fc2cz5adc61.23.5 реле
jqx-14fc2cz5adc61.25 реле
jqx-14fc2cz5adc613.5 реле
jqx-14fc2cz5adc615 реле
jqx-14fc2cz5adc6nil3.5 реле
jqx-14fc2cz5adc6nil5 реле
jqx-14fc2cz6 релес
jqx-14fc2cz6aac120.83.5 реле
jqx-14fc2cz6aac120.85 реле
jqx-14fc2cz6aac121.23.5 реле
jqx-14fc2cz6aac121.25 реле
jqx-14fc2cz6aac1213.5 реле
jqx-14fc2cz6aac1215 реле
jqx-14fc2cz6aac12nil3.5 реле
jqx-14fc2cz6aac12nil5 реле
jqx-14fc2cz6aac240.83.5 реле
jqx-14fc2cz6aac240.85 реле
jqx-14fc2cz6aac241.23.5 реле
jqx-14fc2cz6aac241.25 реле
jqx-14fc2cz6aac2413.5 реле
jqx-14fc2cz6aac2415 реле
jqx-14fc2cz6aac24nil3.5 реле
jqx-14fc2cz6aac24nil5 реле
jqx-14fc2cz6aac60.83.5 реле
jqx-14fc2cz6aac60.85 реле

jqx-14fc2cz6aac61.23.5 реле
jqx-14fc2cz6aac61.25 реле
jqx-14fc2cz6aac613.5 реле
jqx-14fc2cz6aac615 реле
jqx-14fc2cz6aac6nil3.5 реле
jqx-14fc2cz6aac6nil5 реле
jqx-14fc2cz6adc120.83.5 реле
jqx-14fc2cz6adc120.85 реле
jqx-14fc2cz6adc121.23.5 реле
jqx-14fc2cz6adc121.25 реле
jqx-14fc2cz6adc1213.5 реле
jqx-14fc2cz6adc1215 реле
jqx-14fc2cz6adc12nil3.5 реле
jqx-14fc2cz6adc12nil5 реле
jqx-14fc2cz6adc240.83.5 реле
jqx-14fc2cz6adc240.85 реле
jqx-14fc2cz6adc241.23.5 реле
jqx-14fc2cz6adc241.25 реле
jqx-14fc2cz6adc2413.5 реле
jqx-14fc2cz6adc2415 реле
jqx-14fc2cz6adc24nil3.5 реле
jqx-14fc2cz6adc24nil5 реле
jqx-14fc2cz6adc60.83.5 реле
jqx-14fc2cz6adc60.85 реле
jqx-14fc2cz6adc61.23.5 реле
jqx-14fc2cz6adc61.25 реле
jqx-14fc2cz6adc613.5 реле
jqx-14fc2cz6adc615 реле

jqx-14fc2cz6adc6nil3.5 реле
jqx-14fc2cz6adc6nil5 реле
jqx-14fc2cz8 релес
jqx-14fc3 ningbo forward relay corporation
jqx-14fc32as10 релес
jqx-14fc32as16 релес
jqx-14fc32as20 релес
jqx-14fc32as3 релес
jqx-14fc32as5 релес
jqx-14fc32as6 релес
jqx-14fc32as8 релес
jqx-14fc32az10 релес
jqx-14fc32az16 релес
jqx-14fc32az20 релес
jqx-14fc32az3 релес
jqx-14fc32az5 релес
jqx-14fc32az6 релес
jqx-14fc32az8 релес
jqx-14fc32cs10 релес
jqx-14fc32cs16 релес
jqx-14fc32cs20 релес
jqx-14fc32cs3 релес
jqx-14fc32cs5 релес
jqx-14fc32cs6 релес
jqx-14fc32cs8 релес
jqx-14fc32cz10 релес
jqx-14fc32cz16 релес
jqx-14fc32cz20 релес

jqx-14fc32cz3 релес
jqx-14fc32cz5 релес
jqx-14fc32cz6 релес
jqx-14fc32cz8 релес
jqx-14fc3as10 релес
jqx-14fc3as16 релес
jqx-14fc3as20 релес
jqx-14fc3as3 релес
jqx-14fc3as5 релес
jqx-14fc3as6 релес
jqx-14fc3as8 релес
jqx-14fc3az10 релес
jqx-14fc3az16 релес
jqx-14fc3az20 релес
jqx-14fc3az3 релес
jqx-14fc3az5 релес
jqx-14fc3az6 релес
jqx-14fc3az8 релес
jqx-14fc3cs10 релес
jqx-14fc3cs16 релес
jqx-14fc3cs20 релес
jqx-14fc3cs3 релес
jqx-14fc3cs5 релес
jqx-14fc3cs6 релес
jqx-14fc3cs8 релес
jqx-14fc3cz10 релес
jqx-14fc3cz16 релес
jqx-14fc3cz20 релес

jqx-14fc3cz3 релес
jqx-14fc3cz5 релес
jqx-14fc3cz6 релес
jqx-14fc3cz8 релес
jqx-14fcas10aac120.83.5 реле
jqx-14fcas10aac120.85 реле
jqx-14fcas10aac121.23.5 реле
jqx-14fcas10aac121.25 реле
jqx-14fcas10aac1213.5 реле
jqx-14fcas10aac1215 реле
jqx-14fcas10aac12nil3.5 реле
jqx-14fcas10aac12nil5 реле
jqx-14fcas10aac240.83.5 реле
jqx-14fcas10aac240.85 реле
jqx-14fcas10aac241.23.5 реле
jqx-14fcas10aac241.25 реле
jqx-14fcas10aac2413.5 реле
jqx-14fcas10aac2415 реле
jqx-14fcas10aac24nil3.5 реле
jqx-14fcas10aac24nil5 реле
jqx-14fcas10aac60.83.5 реле
jqx-14fcas10aac60.85 реле
jqx-14fcas10aac61.23.5 реле
jqx-14fcas10aac61.25 реле
jqx-14fcas10aac613.5 реле
jqx-14fcas10aac615 реле
jqx-14fcas10aac6nil3.5 реле
jqx-14fcas10aac6nil5 реле

jqx-14fcas10adc120.83.5 реле
jqx-14fcas10adc120.85 реле
jqx-14fcas10adc121.23.5 реле
jqx-14fcas10adc121.25 реле
jqx-14fcas10adc1213.5 реле
jqx-14fcas10adc1215 реле
jqx-14fcas10adc12nil3.5 реле
jqx-14fcas10adc12nil5 реле
jqx-14fcas10adc240.83.5 реле
jqx-14fcas10adc240.85 реле
jqx-14fcas10adc241.23.5 реле
jqx-14fcas10adc241.25 реле
jqx-14fcas10adc2413.5 реле
jqx-14fcas10adc2415 реле
jqx-14fcas10adc24nil3.5 реле
jqx-14fcas10adc24nil5 реле
jqx-14fcas10adc60.83.5реле
jqx-14fcas10adc60.85 реле
jqx-14fcas10adc61.23.5реле
jqx-14fcas10adc61.25 реле
jqx-14fcas10adc613.5 реле
jqx-14fcas10adc615 реле
jqx-14fcas10adc6nil3.5 реле
jqx-14fcas10adc6nil5 реле
jqx-14fcas20aac120.83.5 реле
jqx-14fcas20aac120.85 реле
jqx-14fcas20aac121.23.5 реле
jqx-14fcas20aac121.25 реле

jqx-14fcas20aac1213.5 реле
jqx-14fcas20aac1215 реле
jqx-14fcas20aac12nil3.5 реле
jqx-14fcas20aac12nil5 реле
jqx-14fcas20aac240.83.5 реле
jqx-14fcas20aac240.85 реле
jqx-14fcas20aac241.23.5 реле
jqx-14fcas20aac241.25 реле
jqx-14fcas20aac2413.5 реле
jqx-14fcas20aac2415 реле
jqx-14fcas20aac24nil3.5 реле
jqx-14fcas20aac24nil5 реле
jqx-14fcas20aac60.83.5реле
jqx-14fcas20aac60.85 реле
jqx-14fcas20aac61.23.5реле
jqx-14fcas20aac61.25 реле
jqx-14fcas20aac613.5 реле
jqx-14fcas20aac615 реле
jqx-14fcas20aac6nil3.5 реле
jqx-14fcas20aac6nil5 реле
jqx-14fcas20adc120.83.5 реле
jqx-14fcas20adc120.85 реле
jqx-14fcas20adc121.23.5 реле
jqx-14fcas20adc121.25 реле
jqx-14fcas20adc1213.5 реле
jqx-14fcas20adc1215 реле
jqx-14fcas20adc12nil3.5 реле
jqx-14fcas20adc12nil5 реле

jqx-14fcas20adc240.83.5 реле
jqx-14fcas20adc240.85 реле
jqx-14fcas20adc241.23.5 реле
jqx-14fcas20adc241.25 реле
jqx-14fcas20adc2413.5 реле
jqx-14fcas20adc2415 реле
jqx-14fcas20adc24nil3.5 реле
jqx-14fcas20adc24nil5 реле
jqx-14fcas20adc60.83.5реле
jqx-14fcas20adc60.85 реле
jqx-14fcas20adc61.23.5реле
jqx-14fcas20adc61.25 реле
jqx-14fcas20adc613.5 реле
jqx-14fcas20adc615 реле
jqx-14fcas20adc6nil3.5 реле
jqx-14fcas20adc6nil5 реле
jqx-14fcas3aac120.83.5реле
jqx-14fcas3aac120.85 реле
jqx-14fcas3aac121.23.5реле
jqx-14fcas3aac121.25 реле
jqx-14fcas3aac1213.5 реле
jqx-14fcas3aac1215 реле
jqx-14fcas3aac12nil3.5 реле
jqx-14fcas3aac12nil5 реле
jqx-14fcas3aac240.83.5реле
jqx-14fcas3aac240.85 реле
jqx-14fcas3aac241.23.5реле
jqx-14fcas3aac241.25 реле

jqx-14fcas3aac2413.5 реле
jqx-14fcas3aac2415 реле
jqx-14fcas3aac24nil3.5 реле
jqx-14fcas3aac24nil5 реле
jqx-14fcas3aac60.83.5 реле
jqx-14fcas3aac60.85 реле
jqx-14fcas3aac61.23.5 реле
jqx-14fcas3aac61.25 реле
jqx-14fcas3aac613.5 реле
jqx-14fcas3aac615 реле
jqx-14fcas3aac6nil3.5 реле
jqx-14fcas3aac6nil5 реле
jqx-14fcas3adc120.83.5реле
jqx-14fcas3adc120.85 реле
jqx-14fcas3adc121.23.5реле
jqx-14fcas3adc121.25 реле
jqx-14fcas3adc1213.5 реле
jqx-14fcas3adc1215 реле
jqx-14fcas3adc12nil3.5 реле
jqx-14fcas3adc12nil5 реле
jqx-14fcas3adc240.83.5реле
jqx-14fcas3adc240.85 реле
jqx-14fcas3adc241.23.5реле
jqx-14fcas3adc241.25 реле
jqx-14fcas3adc2413.5 реле
jqx-14fcas3adc2415 реле
jqx-14fcas3adc24nil3.5 реле
jqx-14fcas3adc24nil5 реле

jqx-14fcas3adc60.83.5 реле
jqx-14fcas3adc60.85 реле
jqx-14fcas3adc61.23.5 реле
jqx-14fcas3adc61.25 реле
jqx-14fcas3adc613.5 реле
jqx-14fcas3adc615 реле
jqx-14fcas3adc6nil3.5 реле
jqx-14fcas3adc6nil5 реле
jqx-14fcas5aac120.83.5реле
jqx-14fcas5aac120.85 реле
jqx-14fcas5aac121.23.5реле
jqx-14fcas5aac121.25 реле
jqx-14fcas5aac1213.5 реле
jqx-14fcas5aac1215 реле
jqx-14fcas5aac12nil3.5 реле
jqx-14fcas5aac12nil5 реле
jqx-14fcas5aac240.83.5реле
jqx-14fcas5aac240.85 реле
jqx-14fcas5aac241.23.5реле
jqx-14fcas5aac241.25 реле
jqx-14fcas5aac2413.5 реле
jqx-14fcas5aac2415 реле
jqx-14fcas5aac24nil3.5 реле
jqx-14fcas5aac24nil5 реле
jqx-14fcas5aac60.83.5 реле
jqx-14fcas5aac60.85 реле
jqx-14fcas5aac61.23.5 реле
jqx-14fcas5aac61.25 реле

jqx-14fcas5aac613.5 реле
jqx-14fcas5aac615 реле
jqx-14fcas5aac6nil3.5 реле
jqx-14fcas5aac6nil5 реле
jqx-14fcas5adc120.83.5реле
jqx-14fcas5adc120.85 реле
jqx-14fcas5adc121.23.5реле
jqx-14fcas5adc121.25 реле
jqx-14fcas5adc1213.5 реле
jqx-14fcas5adc1215 реле
jqx-14fcas5adc12nil3.5 реле
jqx-14fcas5adc12nil5 реле
jqx-14fcas5adc240.83.5реле
jqx-14fcas5adc240.85 реле
jqx-14fcas5adc241.23.5реле
jqx-14fcas5adc241.25 реле
jqx-14fcas5adc2413.5 реле
jqx-14fcas5adc2415 реле
jqx-14fcas5adc24nil3.5 реле
jqx-14fcas5adc24nil5 реле
jqx-14fcas5adc60.83.5 реле
jqx-14fcas5adc60.85 реле
jqx-14fcas5adc61.23.5 реле
jqx-14fcas5adc61.25 реле
jqx-14fcas5adc613.5 реле
jqx-14fcas5adc615 реле
jqx-14fcas5adc6nil3.5 реле
jqx-14fcas5adc6nil5 реле

jqx-14fcas6aac120.83.5 реле
jqx-14fcas6aac120.85 реле
jqx-14fcas6aac121.23.5 реле
jqx-14fcas6aac121.25 реле
jqx-14fcas6aac1213.5 реле
jqx-14fcas6aac1215 реле
jqx-14fcas6aac12nil3.5 реле
jqx-14fcas6aac12nil5 реле
jqx-14fcas6aac240.83.5 реле
jqx-14fcas6aac240.85 реле
jqx-14fcas6aac241.23.5 реле
jqx-14fcas6aac241.25 реле
jqx-14fcas6aac2413.5 реле
jqx-14fcas6aac2415 реле
jqx-14fcas6aac24nil3.5 реле
jqx-14fcas6aac24nil5 реле
jqx-14fcas6aac60.83.5 реле
jqx-14fcas6aac60.85 реле
jqx-14fcas6aac61.23.5 реле
jqx-14fcas6aac61.25 реле
jqx-14fcas6aac613.5 реле
jqx-14fcas6aac615 реле
jqx-14fcas6aac6nil3.5 реле
jqx-14fcas6aac6nil5 реле
jqx-14fcas6adc120.83.5 реле
jqx-14fcas6adc120.85 реле
jqx-14fcas6adc121.23.5 реле
jqx-14fcas6adc121.25 реле

jqx-14fcas6adc1213.5 реле
jqx-14fcas6adc1215 реле
jqx-14fcas6adc12nil3.5 реле
jqx-14fcas6adc12nil5 реле
jqx-14fcas6adc240.83.5реле
jqx-14fcas6adc240.85 реле
jqx-14fcas6adc241.23.5реле
jqx-14fcas6adc241.25 реле
jqx-14fcas6adc2413.5 реле
jqx-14fcas6adc2415 реле
jqx-14fcas6adc24nil3.5 реле
jqx-14fcas6adc24nil5 реле
jqx-14fcas6adc60.83.5 реле
jqx-14fcas6adc60.85 реле
jqx-14fcas6adc61.23.5 реле
jqx-14fcas6adc61.25 реле
jqx-14fcas6adc613.5 реле
jqx-14fcas6adc615 реле
jqx-14fcas6adc6nil3.5 реле
jqx-14fcas6adc6nil5 реле
jqx-14fcaz10aac120.83.5 реле
jqx-14fcaz10aac120.85 реле
jqx-14fcaz10aac121.23.5 реле
jqx-14fcaz10aac121.25 реле
jqx-14fcaz10aac1213.5 реле
jqx-14fcaz10aac1215 реле
jqx-14fcaz10aac12nil3.5 реле
jqx-14fcaz10aac12nil5 реле

jqx-14fcaz10aac240.83.5 реле
jqx-14fcaz10aac240.85 реле
jqx-14fcaz10aac241.23.5 реле
jqx-14fcaz10aac241.25 реле
jqx-14fcaz10aac2413.5 реле
jqx-14fcaz10aac2415 реле
jqx-14fcaz10aac24nil3.5 реле
jqx-14fcaz10aac24nil5 реле
jqx-14fcaz10aac60.83.5 реле
jqx-14fcaz10aac60.85 реле
jqx-14fcaz10aac61.23.5 реле
jqx-14fcaz10aac61.25 реле
jqx-14fcaz10aac613.5 реле
jqx-14fcaz10aac615 реле
jqx-14fcaz10aac6nil3.5 реле
jqx-14fcaz10aac6nil5 реле
jqx-14fcaz10adc120.83.5 реле
jqx-14fcaz10adc120.85 реле
jqx-14fcaz10adc121.23.5 реле
jqx-14fcaz10adc121.25 реле
jqx-14fcaz10adc1213.5 реле
jqx-14fcaz10adc1215 реле
jqx-14fcaz10adc12nil3.5 реле
jqx-14fcaz10adc12nil5 реле
jqx-14fcaz10adc240.83.5 реле
jqx-14fcaz10adc240.85 реле
jqx-14fcaz10adc241.23.5 реле
jqx-14fcaz10adc241.25 реле

jqx-14fcaz10adc2413.5 реле
jqx-14fcaz10adc2415 реле
jqx-14fcaz10adc24nil3.5 реле
jqx-14fcaz10adc24nil5 реле
jqx-14fcaz10adc60.83.5реле
jqx-14fcaz10adc60.85 реле
jqx-14fcaz10adc61.23.5реле
jqx-14fcaz10adc61.25 реле
jqx-14fcaz10adc613.5 реле
jqx-14fcaz10adc615 реле
jqx-14fcaz10adc6nil3.5 реле
jqx-14fcaz10adc6nil5 реле
jqx-14fcaz20aac120.83.5 реле
jqx-14fcaz20aac120.85 реле
jqx-14fcaz20aac121.23.5 реле
jqx-14fcaz20aac121.25 реле
jqx-14fcaz20aac1213.5 реле
jqx-14fcaz20aac1215 реле
jqx-14fcaz20aac12nil3.5 реле
jqx-14fcaz20aac12nil5 реле
jqx-14fcaz20aac240.83.5 реле
jqx-14fcaz20aac240.85 реле
jqx-14fcaz20aac241.23.5 реле
jqx-14fcaz20aac241.25 реле
jqx-14fcaz20aac2413.5 реле
jqx-14fcaz20aac2415 реле
jqx-14fcaz20aac24nil3.5 реле
jqx-14fcaz20aac24nil5 реле

jqx-14fcaz20aac60.83.5 реле
jqx-14fcaz20aac60.85 реле
jqx-14fcaz20aac61.23.5 реле
jqx-14fcaz20aac61.25 реле
jqx-14fcaz20aac613.5 реле
jqx-14fcaz20aac615 реле
jqx-14fcaz20aac6nil3.5 реле
jqx-14fcaz20aac6nil5 реле
jqx-14fcaz20adc120.83.5 реле
jqx-14fcaz20adc120.85 реле
jqx-14fcaz20adc121.23.5 реле
jqx-14fcaz20adc121.25 реле
jqx-14fcaz20adc1213.5 реле
jqx-14fcaz20adc1215 реле
jqx-14fcaz20adc12nil3.5 реле
jqx-14fcaz20adc12nil5 реле
jqx-14fcaz20adc240.83.5 реле
jqx-14fcaz20adc240.85 реле
jqx-14fcaz20adc241.23.5 реле
jqx-14fcaz20adc241.25 реле
jqx-14fcaz20adc2413.5 реле
jqx-14fcaz20adc2415 реле
jqx-14fcaz20adc24nil3.5 реле
jqx-14fcaz20adc24nil5 реле
jqx-14fcaz20adc60.83.5 реле
jqx-14fcaz20adc60.85 реле
jqx-14fcaz20adc61.23.5 реле
jqx-14fcaz20adc61.25 реле

jqx-14fcaz20adc613.5 реле
jqx-14fcaz20adc615 реле
jqx-14fcaz20adc6nil3.5 реле
jqx-14fcaz20adc6nil5 реле
jqx-14fcaz3aac120.83.5 реле
jqx-14fcaz3aac120.85 реле
jqx-14fcaz3aac121.23.5 реле
jqx-14fcaz3aac121.25 реле
jqx-14fcaz3aac1213.5 реле
jqx-14fcaz3aac1215 реле
jqx-14fcaz3aac12nil3.5 реле
jqx-14fcaz3aac12nil5 реле
jqx-14fcaz3aac240.83.5 реле
jqx-14fcaz3aac240.85 реле
jqx-14fcaz3aac241.23.5 реле
jqx-14fcaz3aac241.25 реле
jqx-14fcaz3aac2413.5 реле
jqx-14fcaz3aac2415 реле
jqx-14fcaz3aac24nil3.5 реле
jqx-14fcaz3aac24nil5 реле
jqx-14fcaz3aac60.83.5 реле
jqx-14fcaz3aac60.85 реле
jqx-14fcaz3aac61.23.5 реле
jqx-14fcaz3aac61.25 реле
jqx-14fcaz3aac613.5 реле
jqx-14fcaz3aac615 реле
jqx-14fcaz3aac6nil3.5 реле
jqx-14fcaz3aac6nil5 реле

jqx-14fcaz3adc120.83.5 реле
jqx-14fcaz3adc120.85 реле
jqx-14fcaz3adc121.23.5 реле
jqx-14fcaz3adc121.25 реле
jqx-14fcaz3adc1213.5 реле
jqx-14fcaz3adc1215 реле
jqx-14fcaz3adc12nil3.5 реле
jqx-14fcaz3adc12nil5 реле
jqx-14fcaz3adc240.83.5 реле
jqx-14fcaz3adc240.85 реле
jqx-14fcaz3adc241.23.5 реле
jqx-14fcaz3adc241.25 реле
jqx-14fcaz3adc2413.5 реле
jqx-14fcaz3adc2415 реле
jqx-14fcaz3adc24nil3.5 реле
jqx-14fcaz3adc24nil5 реле
jqx-14fcaz3adc60.83.5 реле
jqx-14fcaz3adc60.85 реле
jqx-14fcaz3adc61.23.5 реле
jqx-14fcaz3adc61.25 реле
jqx-14fcaz3adc613.5 реле
jqx-14fcaz3adc615 реле
jqx-14fcaz3adc6nil3.5 реле
jqx-14fcaz3adc6nil5 реле
jqx-14fcaz5aac120.83.5 реле
jqx-14fcaz5aac120.85 реле
jqx-14fcaz5aac121.23.5 реле
jqx-14fcaz5aac121.25 реле

jqx-14fcaz5aac1213.5 реле
jqx-14fcaz5aac1215 реле
jqx-14fcaz5aac12nil3.5 реле
jqx-14fcaz5aac12nil5 реле
jqx-14fcaz5aac240.83.5 реле
jqx-14fcaz5aac240.85 реле
jqx-14fcaz5aac241.23.5 реле
jqx-14fcaz5aac241.25 реле
jqx-14fcaz5aac2413.5 реле
jqx-14fcaz5aac2415 реле
jqx-14fcaz5aac24nil3.5 реле
jqx-14fcaz5aac24nil5 реле
jqx-14fcaz5aac60.83.5 реле
jqx-14fcaz5aac60.85 реле
jqx-14fcaz5aac61.23.5 реле
jqx-14fcaz5aac61.25 реле
jqx-14fcaz5aac613.5 реле
jqx-14fcaz5aac615 реле
jqx-14fcaz5aac6nil3.5 реле
jqx-14fcaz5aac6nil5 реле
jqx-14fcaz5adc120.83.5 реле
jqx-14fcaz5adc120.85 реле
jqx-14fcaz5adc121.23.5 реле
jqx-14fcaz5adc121.25 реле
jqx-14fcaz5adc1213.5 реле
jqx-14fcaz5adc1215 реле
jqx-14fcaz5adc12nil3.5 реле
jqx-14fcaz5adc12nil5 реле

jqx-14fcaz5adc240.83.5 реле
jqx-14fcaz5adc240.85 реле
jqx-14fcaz5adc241.23.5 реле
jqx-14fcaz5adc241.25 реле
jqx-14fcaz5adc2413.5 реле
jqx-14fcaz5adc2415 реле
jqx-14fcaz5adc24nil3.5 реле
jqx-14fcaz5adc24nil5 реле
jqx-14fcaz5adc60.83.5 реле
jqx-14fcaz5adc60.85 реле
jqx-14fcaz5adc61.23.5 реле
jqx-14fcaz5adc61.25 реле
jqx-14fcaz5adc613.5 реле
jqx-14fcaz5adc615 реле
jqx-14fcaz5adc6nil3.5 реле
jqx-14fcaz5adc6nil5 реле
jqx-14fcaz6aac120.83.5 реле
jqx-14fcaz6aac120.85 реле
jqx-14fcaz6aac121.23.5 реле
jqx-14fcaz6aac121.25 реле
jqx-14fcaz6aac1213.5 реле
jqx-14fcaz6aac1215 реле
jqx-14fcaz6aac12nil3.5 реле
jqx-14fcaz6aac12nil5 реле
jqx-14fcaz6aac240.83.5 реле
jqx-14fcaz6aac240.85 реле
jqx-14fcaz6aac241.23.5 реле
jqx-14fcaz6aac241.25 реле

jqx-14fcaz6aac2413.5 реле
jqx-14fcaz6aac2415 реле
jqx-14fcaz6aac24nil3.5 реле
jqx-14fcaz6aac24nil5 реле
jqx-14fcaz6aac60.83.5 реле
jqx-14fcaz6aac60.85 реле
jqx-14fcaz6aac61.23.5 реле
jqx-14fcaz6aac61.25 реле
jqx-14fcaz6aac613.5 реле
jqx-14fcaz6aac615 реле
jqx-14fcaz6aac6nil3.5 реле
jqx-14fcaz6aac6nil5 реле
jqx-14fcaz6adc120.83.5реле
jqx-14fcaz6adc120.85 реле
jqx-14fcaz6adc121.23.5реле
jqx-14fcaz6adc121.25 реле
jqx-14fcaz6adc1213.5 реле
jqx-14fcaz6adc1215 реле
jqx-14fcaz6adc12nil3.5 реле
jqx-14fcaz6adc12nil5 реле
jqx-14fcaz6adc240.83.5реле
jqx-14fcaz6adc240.85 реле
jqx-14fcaz6adc241.23.5реле
jqx-14fcaz6adc241.25 реле
jqx-14fcaz6adc2413.5 реле
jqx-14fcaz6adc2415 реле
jqx-14fcaz6adc24nil3.5 реле
jqx-14fcaz6adc24nil5 реле

jqx-14fcaz6adc60.83.5 реле
jqx-14fcaz6adc60.85 реле
jqx-14fcaz6adc61.23.5 реле
jqx-14fcaz6adc61.25 реле
jqx-14fcaz6adc613.5 реле
jqx-14fcaz6adc615 реле
jqx-14fcaz6adc6nil3.5 реле
jqx-14fcaz6adc6nil5 реле
jqx-14fccs10aac120.83.5 реле
jqx-14fccs10aac120.85 реле
jqx-14fccs10aac121.23.5 реле
jqx-14fccs10aac121.25 реле
jqx-14fccs10aac1213.5 реле
jqx-14fccs10aac1215 реле
jqx-14fccs10aac12nil3.5 реле
jqx-14fccs10aac12nil5 реле
jqx-14fccs10aac240.83.5 реле
jqx-14fccs10aac240.85 реле
jqx-14fccs10aac241.23.5 реле
jqx-14fccs10aac241.25 реле
jqx-14fccs10aac2413.5 реле
jqx-14fccs10aac2415 реле
jqx-14fccs10aac24nil3.5 реле
jqx-14fccs10aac24nil5 реле
jqx-14fccs10aac60.83.5 реле
jqx-14fccs10aac60.85 реле
jqx-14fccs10aac61.23.5 реле
jqx-14fccs10aac61.25 реле

jqx-14fcss10aac613.5 реле
jqx-14fcss10aac615 реле
jqx-14fcss10aac6nil3.5 реле
jqx-14fcss10aac6nil5 реле
jqx-14fcss10adc120.83.5 реле
jqx-14fcss10adc120.85 реле
jqx-14fcss10adc121.23.5 реле
jqx-14fcss10adc121.25 реле
jqx-14fcss10adc1213.5 реле
jqx-14fcss10adc1215 реле
jqx-14fcss10adc12nil3.5 реле
jqx-14fcss10adc12nil5 реле
jqx-14fcss10adc240.83.5 реле
jqx-14fcss10adc240.85 реле
jqx-14fcss10adc241.23.5 реле
jqx-14fcss10adc241.25 реле
jqx-14fcss10adc2413.5 реле
jqx-14fcss10adc2415 реле
jqx-14fcss10adc24nil3.5 реле
jqx-14fcss10adc24nil5 реле
jqx-14fcss10adc60.83.5 реле
jqx-14fcss10adc60.85 реле
jqx-14fcss10adc61.23.5 реле
jqx-14fcss10adc61.25 реле
jqx-14fcss10adc613.5 реле
jqx-14fcss10adc615 реле
jqx-14fcss10adc6nil3.5 реле
jqx-14fcss10adc6nil5 реле

jqx-14fccs10dc12v0.83.5	ningbo forward relay corporation
jqx-14fccs20aac120.83.5	реле
jqx-14fccs20aac120.85	реле
jqx-14fccs20aac121.23.5	реле
jqx-14fccs20aac121.25	реле
jqx-14fccs20aac1213.5	реле
jqx-14fccs20aac1215	реле
jqx-14fccs20aac12nil3.5	реле
jqx-14fccs20aac12nil5	реле
jqx-14fccs20aac240.83.5	реле
jqx-14fccs20aac240.85	реле
jqx-14fccs20aac241.23.5	реле
jqx-14fccs20aac241.25	реле
jqx-14fccs20aac2413.5	реле
jqx-14fccs20aac2415	реле
jqx-14fccs20aac24nil3.5	реле
jqx-14fccs20aac24nil5	реле
jqx-14fccs20aac60.83.5	реле
jqx-14fccs20aac60.85	реле
jqx-14fccs20aac61.23.5	реле
jqx-14fccs20aac61.25	реле
jqx-14fccs20aac613.5	реле
jqx-14fccs20aac615	реле
jqx-14fccs20aac6nil3.5	реле
jqx-14fccs20aac6nil5	реле
jqx-14fccs20adc120.83.5	реле
jqx-14fccs20adc120.85	реле
jqx-14fccs20adc121.23.5	реле

jqx-14fcss20adc121.25 реле
jqx-14fcss20adc1213.5 реле
jqx-14fcss20adc1215 реле
jqx-14fcss20adc12nil3.5 реле
jqx-14fcss20adc12nil5 реле
jqx-14fcss20adc240.83.5 реле
jqx-14fcss20adc240.85 реле
jqx-14fcss20adc241.23.5 реле
jqx-14fcss20adc241.25 реле
jqx-14fcss20adc2413.5 реле
jqx-14fcss20adc2415 реле
jqx-14fcss20adc24nil3.5 реле
jqx-14fcss20adc24nil5 реле
jqx-14fcss20adc60.83.5 реле
jqx-14fcss20adc60.85 реле
jqx-14fcss20adc61.23.5 реле
jqx-14fcss20adc61.25 реле
jqx-14fcss20adc613.5 реле
jqx-14fcss20adc615 реле
jqx-14fcss20adc6nil3.5 реле
jqx-14fcss20adc6nil5 реле
jqx-14fcss3aac120.83.5 реле
jqx-14fcss3aac120.85 реле
jqx-14fcss3aac121.23.5 реле
jqx-14fcss3aac121.25 реле
jqx-14fcss3aac1213.5 реле
jqx-14fcss3aac1215 реле
jqx-14fcss3aac12nil3.5 реле

jqx-14fccc3aac12nil5 реле
jqx-14fccc3aac240.83.5 реле
jqx-14fccc3aac240.85 реле
jqx-14fccc3aac241.23.5 реле
jqx-14fccc3aac241.25 реле
jqx-14fccc3aac2413.5 реле
jqx-14fccc3aac2415 реле
jqx-14fccc3aac24nil3.5 реле
jqx-14fccc3aac24nil5 реле
jqx-14fccc3aac60.83.5 реле
jqx-14fccc3aac60.85 реле
jqx-14fccc3aac61.23.5 реле
jqx-14fccc3aac61.25 реле
jqx-14fccc3aac613.5 реле
jqx-14fccc3aac615 реле
jqx-14fccc3aac6nil3.5 реле
jqx-14fccc3aac6nil5 реле
jqx-14fccc3adc120.83.5 реле
jqx-14fccc3adc120.85 реле
jqx-14fccc3adc121.23.5 реле
jqx-14fccc3adc121.25 реле
jqx-14fccc3adc1213.5 реле
jqx-14fccc3adc1215 реле
jqx-14fccc3adc12nil3.5 реле
jqx-14fccc3adc12nil5 реле
jqx-14fccc3adc240.83.5 реле
jqx-14fccc3adc240.85 реле
jqx-14fccc3adc241.23.5 реле

jqx-14fccc3adc241.25 реле
jqx-14fccc3adc2413.5 реле
jqx-14fccc3adc2415 реле
jqx-14fccc3adc24nil3.5 реле
jqx-14fccc3adc24nil5 реле
jqx-14fccc3adc60.83.5 реле
jqx-14fccc3adc60.85 реле
jqx-14fccc3adc61.23.5 реле
jqx-14fccc3adc61.25 реле
jqx-14fccc3adc613.5 реле
jqx-14fccc3adc615 реле
jqx-14fccc3adc6nil3.5 реле
jqx-14fccc3adc6nil5 реле
jqx-14fccc5aac120.83.5 реле
jqx-14fccc5aac120.85 реле
jqx-14fccc5aac121.23.5 реле
jqx-14fccc5aac121.25 реле
jqx-14fccc5aac1213.5 реле
jqx-14fccc5aac1215 реле
jqx-14fccc5aac12nil3.5 реле
jqx-14fccc5aac12nil5 реле
jqx-14fccc5aac240.83.5 реле
jqx-14fccc5aac240.85 реле
jqx-14fccc5aac241.23.5 реле
jqx-14fccc5aac241.25 реле
jqx-14fccc5aac2413.5 реле
jqx-14fccc5aac2415 реле
jqx-14fccc5aac24nil3.5 реле

jqx-14fcss5aac24nil5 реле
jqx-14fcss5aac60.83.5 реле
jqx-14fcss5aac60.85 реле
jqx-14fcss5aac61.23.5 реле
jqx-14fcss5aac61.25 реле
jqx-14fcss5aac613.5 реле
jqx-14fcss5aac615 реле
jqx-14fcss5aac6nil3.5 реле
jqx-14fcss5aac6nil5 реле
jqx-14fcss5adc120.83.5 реле
jqx-14fcss5adc120.85 реле
jqx-14fcss5adc121.23.5 реле
jqx-14fcss5adc121.25 реле
jqx-14fcss5adc1213.5 реле
jqx-14fcss5adc1215 реле
jqx-14fcss5adc12nil3.5 реле
jqx-14fcss5adc12nil5 реле
jqx-14fcss5adc240.83.5 реле
jqx-14fcss5adc240.85 реле
jqx-14fcss5adc241.23.5 реле
jqx-14fcss5adc241.25 реле
jqx-14fcss5adc2413.5 реле
jqx-14fcss5adc2415 реле
jqx-14fcss5adc24nil3.5 реле
jqx-14fcss5adc24nil5 реле
jqx-14fcss5adc60.83.5 реле
jqx-14fcss5adc60.85 реле
jqx-14fcss5adc61.23.5 реле

jqx-14fcss5adc61.25 реле
jqx-14fcss5adc613.5 реле
jqx-14fcss5adc615 реле
jqx-14fcss5adc6nil3.5 реле
jqx-14fcss5adc6nil5 реле
jqx-14fcss6aac120.83.5 реле
jqx-14fcss6aac120.85 реле
jqx-14fcss6aac121.23.5 реле
jqx-14fcss6aac121.25 реле
jqx-14fcss6aac1213.5 реле
jqx-14fcss6aac1215 реле
jqx-14fcss6aac12nil3.5 реле
jqx-14fcss6aac12nil5 реле
jqx-14fcss6aac240.83.5 реле
jqx-14fcss6aac240.85 реле
jqx-14fcss6aac241.23.5 реле
jqx-14fcss6aac241.25 реле
jqx-14fcss6aac2413.5 реле
jqx-14fcss6aac2415 реле
jqx-14fcss6aac24nil3.5 реле
jqx-14fcss6aac24nil5 реле
jqx-14fcss6aac60.83.5 реле
jqx-14fcss6aac60.85 реле
jqx-14fcss6aac61.23.5 реле
jqx-14fcss6aac61.25 реле
jqx-14fcss6aac613.5 реле
jqx-14fcss6aac615 реле
jqx-14fcss6aac6nil3.5 реле

jqx-14fcss6aac6nil5 реле
jqx-14fcss6adc120.83.5 реле
jqx-14fcss6adc120.85 реле
jqx-14fcss6adc121.23.5 реле
jqx-14fcss6adc121.25 реле
jqx-14fcss6adc1213.5 реле
jqx-14fcss6adc1215 реле
jqx-14fcss6adc12nil3.5 реле
jqx-14fcss6adc12nil5 реле
jqx-14fcss6adc240.83.5 реле
jqx-14fcss6adc240.85 реле
jqx-14fcss6adc241.23.5 реле
jqx-14fcss6adc241.25 реле
jqx-14fcss6adc2413.5 реле
jqx-14fcss6adc2415 реле
jqx-14fcss6adc24nil3.5 реле
jqx-14fcss6adc24nil5 реле
jqx-14fcss6adc60.83.5 реле
jqx-14fcss6adc60.85 реле
jqx-14fcss6adc61.23.5 реле
jqx-14fcss6adc61.25 реле
jqx-14fcss6adc613.5 реле
jqx-14fcss6adc615 реле
jqx-14fcss6adc6nil3.5 реле
jqx-14fcss6adc6nil5 реле
jqx-14fccz10aac120.83.5 реле
jqx-14fccz10aac120.85 реле
jqx-14fccz10aac121.23.5 реле

jqx-14fccz10aac121.25 реле
jqx-14fccz10aac1213.5 реле
jqx-14fccz10aac1215 реле
jqx-14fccz10aac12nil3.5 реле
jqx-14fccz10aac12nil5 реле
jqx-14fccz10aac240.83.5 реле
jqx-14fccz10aac240.85 реле
jqx-14fccz10aac241.23.5 реле
jqx-14fccz10aac241.25 реле
jqx-14fccz10aac2413.5 реле
jqx-14fccz10aac2415 реле
jqx-14fccz10aac24nil3.5 реле
jqx-14fccz10aac24nil5 реле
jqx-14fccz10aac60.83.5 реле
jqx-14fccz10aac60.85 реле
jqx-14fccz10aac61.23.5 реле
jqx-14fccz10aac61.25 реле
jqx-14fccz10aac613.5 реле
jqx-14fccz10aac615 реле
jqx-14fccz10aac6nil3.5 реле
jqx-14fccz10aac6nil5 реле
jqx-14fccz10adc120.83.5 реле
jqx-14fccz10adc120.85 реле
jqx-14fccz10adc121.23.5 реле
jqx-14fccz10adc121.25 реле
jqx-14fccz10adc1213.5 реле
jqx-14fccz10adc1215 реле
jqx-14fccz10adc12nil3.5 реле

jqx-14fccz10adc12nil5 реле
jqx-14fccz10adc240.83.5 реле
jqx-14fccz10adc240.85 реле
jqx-14fccz10adc241.23.5 реле
jqx-14fccz10adc241.25 реле
jqx-14fccz10adc2413.5 реле
jqx-14fccz10adc2415 реле
jqx-14fccz10adc24nil3.5 реле
jqx-14fccz10adc24nil5 реле
jqx-14fccz10adc60.83.5 реле
jqx-14fccz10adc60.85 реле
jqx-14fccz10adc61.23.5 реле
jqx-14fccz10adc61.25 реле
jqx-14fccz10adc613.5 реле
jqx-14fccz10adc615 реле
jqx-14fccz10adc6nil3.5 реле
jqx-14fccz10adc6nil5 реле
jqx-14fccz20aac120.83.5 реле
jqx-14fccz20aac120.85 реле
jqx-14fccz20aac121.23.5 реле
jqx-14fccz20aac121.25 реле
jqx-14fccz20aac1213.5 реле
jqx-14fccz20aac1215 реле
jqx-14fccz20aac12nil3.5 реле
jqx-14fccz20aac12nil5 реле
jqx-14fccz20aac240.83.5 реле
jqx-14fccz20aac240.85 реле
jqx-14fccz20aac241.23.5 реле

jqx-14fccz20aac241.25 реле
jqx-14fccz20aac2413.5 реле
jqx-14fccz20aac2415 реле
jqx-14fccz20aac24nil3.5 реле
jqx-14fccz20aac24nil5 реле
jqx-14fccz20aac60.83.5 реле
jqx-14fccz20aac60.85 реле
jqx-14fccz20aac61.23.5 реле
jqx-14fccz20aac61.25 реле
jqx-14fccz20aac613.5 реле
jqx-14fccz20aac615 реле
jqx-14fccz20aac6nil3.5 реле
jqx-14fccz20aac6nil5 реле
jqx-14fccz20adc120.83.5 реле
jqx-14fccz20adc120.85 реле
jqx-14fccz20adc121.23.5 реле
jqx-14fccz20adc121.25 реле
jqx-14fccz20adc1213.5 реле
jqx-14fccz20adc1215 реле
jqx-14fccz20adc12nil3.5 реле
jqx-14fccz20adc12nil5 реле
jqx-14fccz20adc240.83.5 реле
jqx-14fccz20adc240.85 реле
jqx-14fccz20adc241.23.5 реле
jqx-14fccz20adc241.25 реле
jqx-14fccz20adc2413.5 реле
jqx-14fccz20adc2415 реле
jqx-14fccz20adc24nil3.5 реле

jqx-14fccz20adc24nil5 реле
jqx-14fccz20adc60.83.5 реле
jqx-14fccz20adc60.85 реле
jqx-14fccz20adc61.23.5 реле
jqx-14fccz20adc61.25 реле
jqx-14fccz20adc613.5 реле
jqx-14fccz20adc615 реле
jqx-14fccz20adc6nil3.5 реле
jqx-14fccz20adc6nil5 реле
jqx-14fccz3aac120.83.5 реле
jqx-14fccz3aac120.85 реле
jqx-14fccz3aac121.23.5 реле
jqx-14fccz3aac121.25 реле
jqx-14fccz3aac1213.5 реле
jqx-14fccz3aac1215 реле
jqx-14fccz3aac12nil3.5 реле
jqx-14fccz3aac12nil5 реле
jqx-14fccz3aac240.83.5 реле
jqx-14fccz3aac240.85 реле
jqx-14fccz3aac241.23.5 реле
jqx-14fccz3aac241.25 реле
jqx-14fccz3aac2413.5 реле
jqx-14fccz3aac2415 реле
jqx-14fccz3aac24nil3.5 реле
jqx-14fccz3aac24nil5 реле
jqx-14fccz3aac60.83.5 реле
jqx-14fccz3aac60.85 реле
jqx-14fccz3aac61.23.5 реле

jqx-14fccz3aac61.25 реле
jqx-14fccz3aac613.5 реле
jqx-14fccz3aac615 реле
jqx-14fccz3aac6nil3.5 реле
jqx-14fccz3aac6nil5 реле
jqx-14fccz3adc120.83.5 реле
jqx-14fccz3adc120.85 реле
jqx-14fccz3adc121.23.5 реле
jqx-14fccz3adc121.25 реле
jqx-14fccz3adc1213.5 реле
jqx-14fccz3adc1215 реле
jqx-14fccz3adc12nil3.5 реле
jqx-14fccz3adc12nil5 реле
jqx-14fccz3adc240.83.5 реле
jqx-14fccz3adc240.85 реле
jqx-14fccz3adc241.23.5 реле
jqx-14fccz3adc241.25 реле
jqx-14fccz3adc2413.5 реле
jqx-14fccz3adc2415 реле
jqx-14fccz3adc24nil3.5 реле
jqx-14fccz3adc24nil5 реле
jqx-14fccz3adc60.83.5 реле
jqx-14fccz3adc60.85 реле
jqx-14fccz3adc61.23.5 реле
jqx-14fccz3adc61.25 реле
jqx-14fccz3adc613.5 реле
jqx-14fccz3adc615 реле
jqx-14fccz3adc6nil3.5 реле

jqx-14fccz3adc6nil5 реле
jqx-14fccz5aac120.83.5 реле
jqx-14fccz5aac120.85 реле
jqx-14fccz5aac121.23.5 реле
jqx-14fccz5aac121.25 реле
jqx-14fccz5aac1213.5 реле
jqx-14fccz5aac1215 реле
jqx-14fccz5aac12nil3.5 реле
jqx-14fccz5aac12nil5 реле
jqx-14fccz5aac240.83.5 реле
jqx-14fccz5aac240.85 реле
jqx-14fccz5aac241.23.5 реле
jqx-14fccz5aac241.25 реле
jqx-14fccz5aac2413.5 реле
jqx-14fccz5aac2415 реле
jqx-14fccz5aac24nil3.5 реле
jqx-14fccz5aac24nil5 реле
jqx-14fccz5aac60.83.5 реле
jqx-14fccz5aac60.85 реле
jqx-14fccz5aac61.23.5 реле
jqx-14fccz5aac61.25 реле
jqx-14fccz5aac613.5 реле
jqx-14fccz5aac615 реле
jqx-14fccz5aac6nil3.5 реле
jqx-14fccz5aac6nil5 реле
jqx-14fccz5adc120.83.5 реле
jqx-14fccz5adc120.85 реле
jqx-14fccz5adc121.23.5 реле

jqx-14fccz5adc121.25 реле
jqx-14fccz5adc1213.5 реле
jqx-14fccz5adc1215 реле
jqx-14fccz5adc12nil3.5 реле
jqx-14fccz5adc12nil5 реле
jqx-14fccz5adc240.83.5 реле
jqx-14fccz5adc240.85 реле
jqx-14fccz5adc241.23.5 реле
jqx-14fccz5adc241.25 реле
jqx-14fccz5adc2413.5 реле
jqx-14fccz5adc2415 реле
jqx-14fccz5adc24nil3.5 реле
jqx-14fccz5adc24nil5 реле
jqx-14fccz5adc60.83.5 реле
jqx-14fccz5adc60.85 реле
jqx-14fccz5adc61.23.5 реле
jqx-14fccz5adc61.25 реле
jqx-14fccz5adc613.5 реле
jqx-14fccz5adc615 реле
jqx-14fccz5adc6nil3.5 реле
jqx-14fccz5adc6nil5 реле
jqx-14fccz6aac120.83.5 реле
jqx-14fccz6aac120.85 реле
jqx-14fccz6aac121.23.5 реле
jqx-14fccz6aac121.25 реле
jqx-14fccz6aac1213.5 реле
jqx-14fccz6aac1215 реле
jqx-14fccz6aac12nil3.5 реле

jqx-14fccz6aac12nil5 реле
jqx-14fccz6aac240.83.5 реле
jqx-14fccz6aac240.85 реле
jqx-14fccz6aac241.23.5 реле
jqx-14fccz6aac241.25 реле
jqx-14fccz6aac2413.5 реле
jqx-14fccz6aac2415 реле
jqx-14fccz6aac24nil3.5 реле
jqx-14fccz6aac24nil5 реле
jqx-14fccz6aac60.83.5 реле
jqx-14fccz6aac60.85 реле
jqx-14fccz6aac61.23.5 реле
jqx-14fccz6aac61.25 реле
jqx-14fccz6aac613.5 реле
jqx-14fccz6aac615 реле
jqx-14fccz6aac6nil3.5 реле
jqx-14fccz6aac6nil5 реле
jqx-14fccz6adc120.83.5 реле
jqx-14fccz6adc120.85 реле
jqx-14fccz6adc121.23.5 реле
jqx-14fccz6adc121.25 реле
jqx-14fccz6adc1213.5 реле
jqx-14fccz6adc1215 реле
jqx-14fccz6adc12nil3.5 реле
jqx-14fccz6adc12nil5 реле
jqx-14fccz6adc240.83.5 реле
jqx-14fccz6adc240.85 реле
jqx-14fccz6adc241.23.5 реле

jqx-14fccz6adc241.25 реле
jqx-14fccz6adc2413.5 реле
jqx-14fccz6adc2415 реле
jqx-14fccz6adc24nil3.5 реле
jqx-14fccz6adc24nil5 реле
jqx-14fccz6adc60.83.5 реле
jqx-14fccz6adc60.85 реле
jqx-14fccz6adc61.23.5 реле
jqx-14fccz6adc61.25 реле
jqx-14fccz6adc613.5 реле
jqx-14fccz6adc615 реле
jqx-14fccz6adc6nil3.5 реле
jqx-14fccz6adc6nil5 реле
jqx-14fc_07 реле
jqx-14ff реле
jqx-14ff/012-1zw hongfa, dip 2010
jqx-14ff/121h реле
jqx-14ff/121hs реле
jqx-14ff/121z реле
jqx-14ff/121zs реле
jqx-14ff/181h реле
jqx-14ff/181hs реле
jqx-14ff/181z реле
jqx-14ff/181zs реле
jqx-14ff/241h реле
jqx-14ff/241hs реле
jqx-14ff/241z реле
jqx-14ff/241zs реле

jqx-14ff/31h реле
jqx-14ff/31hs реле
jqx-14ff/31z реле
jqx-14ff/31zs реле
jqx-14ff/481h реле
jqx-14ff/481hs реле
jqx-14ff/481z реле
jqx-14ff/481zs реле
jqx-14ff/51h реле
jqx-14ff/51hs реле
jqx-14ff/51z реле
jqx-14ff/51zs реле
jqx-14ff/601h реле
jqx-14ff/601hs реле
jqx-14ff/601z реле
jqx-14ff/601zs реле
jqx-14ff/61h реле
jqx-14ff/61hs реле
jqx-14ff/61z реле
jqx-14ff/61zs реле
jqx-14ff/91h реле
jqx-14ff/91hs реле
jqx-14ff/91z реле
jqx-14ff/91zs реле

jqx-14ff121hnil etc1 [list of unclassified manufacturers], single-pole, 10a, pc borad & qc terminal

jqx-14ff121hqc etc1 [list of unclassified manufacturers], single-pole, 10a, pc borad & qc terminal

jqx-14ff121hs etc1 [list of unclassified manufacturers], single-pole, 10a, pc borad & qc terminal

jqx-14ff121znil etc1 [list of unclassified manufacturers], single-pole, 10a, pc borad & qc terminal

jqx-14ff121zqc etc1 [list of unclassified manufacturers], single-pole, 10a, pc borad & qc terminal
jqx-14ff121zs etc1 [list of unclassified manufacturers], single-pole, 10a, pc borad & qc terminal
jqx-14ff181hnil etc1 [list of unclassified manufacturers], single-pole, 10a, pc borad & qc terminal
jqx-14ff181hqc etc1 [list of unclassified manufacturers], single-pole, 10a, pc borad & qc terminal
jqx-14ff181hs etc1 [list of unclassified manufacturers], single-pole, 10a, pc borad & qc terminal
jqx-14ff181znil etc1 [list of unclassified manufacturers], single-pole, 10a, pc borad & qc terminal
jqx-14ff181zqc etc1 [list of unclassified manufacturers], single-pole, 10a, pc borad & qc terminal
jqx-14ff181zs etc1 [list of unclassified manufacturers], single-pole, 10a, pc borad & qc terminal
jqx-14ff241hnil etc1 [list of unclassified manufacturers], single-pole, 10a, pc borad & qc terminal
jqx-14ff241hqc etc1 [list of unclassified manufacturers], single-pole, 10a, pc borad & qc terminal
jqx-14ff241hs etc1 [list of unclassified manufacturers], single-pole, 10a, pc borad & qc terminal
jqx-14ff241znil etc1 [list of unclassified manufacturers], single-pole, 10a, pc borad & qc terminal
jqx-14ff241zqc etc1 [list of unclassified manufacturers], single-pole, 10a, pc borad & qc terminal
jqx-14ff241zs etc1 [list of unclassified manufacturers], single-pole, 10a, pc borad & qc terminal
jqx-14ff31hnil etc1 [list of unclassified manufacturers], single-pole, 10a, pc borad & qc terminal
jqx-14ff31hqc etc1 [list of unclassified manufacturers], single-pole, 10a, pc borad & qc terminal
jqx-14ff31hs etc1 [list of unclassified manufacturers], single-pole, 10a, pc borad & qc terminal
jqx-14ff31znil etc1 [list of unclassified manufacturers], single-pole, 10a, pc borad & qc terminal
jqx-14ff31zqc etc1 [list of unclassified manufacturers], single-pole, 10a, pc borad & qc terminal
jqx-14ff31zs etc1 [list of unclassified manufacturers], single-pole, 10a, pc borad & qc terminal
jqx-14ff481hnil etc1 [list of unclassified manufacturers], single-pole, 10a, pc borad & qc terminal
jqx-14ff481hqc etc1 [list of unclassified manufacturers], single-pole, 10a, pc borad & qc terminal
jqx-14ff481hs etc1 [list of unclassified manufacturers], single-pole, 10a, pc borad & qc terminal
jqx-14ff481znil etc1 [list of unclassified manufacturers], single-pole, 10a, pc borad & qc terminal
jqx-14ff481zqc etc1 [list of unclassified manufacturers], single-pole, 10a, pc borad & qc terminal
jqx-14ff481zs etc1 [list of unclassified manufacturers], single-pole, 10a, pc borad & qc terminal
jqx-14ff51hnil etc1 [list of unclassified manufacturers], single-pole, 10a, pc borad & qc terminal
jqx-14ff51hqc etc1 [list of unclassified manufacturers], single-pole, 10a, pc borad & qc terminal

jqx-14ff51hs etc1 [list of unclassified manufacturers], single-pole, 10a, pc borad & qc terminal
jqx-14ff51znll etc1 [list of unclassified manufacturers], single-pole, 10a, pc borad & qc terminal
jqx-14ff51zqc etc1 [list of unclassified manufacturers], single-pole, 10a, pc borad & qc terminal
jqx-14ff51zs etc1 [list of unclassified manufacturers], single-pole, 10a, pc borad & qc terminal
jqx-14ff601hnll etc1 [list of unclassified manufacturers], single-pole, 10a, pc borad & qc terminal
jqx-14ff601hqc etc1 [list of unclassified manufacturers], single-pole, 10a, pc borad & qc terminal
jqx-14ff601hs etc1 [list of unclassified manufacturers], single-pole, 10a, pc borad & qc terminal
jqx-14ff601znll etc1 [list of unclassified manufacturers], single-pole, 10a, pc borad & qc terminal
jqx-14ff601zqc etc1 [list of unclassified manufacturers], single-pole, 10a, pc borad & qc terminal
jqx-14ff601zs etc1 [list of unclassified manufacturers], single-pole, 10a, pc borad & qc terminal
jqx-14ff61hnll etc1 [list of unclassified manufacturers], single-pole, 10a, pc borad & qc terminal
jqx-14ff61hqc etc1 [list of unclassified manufacturers], single-pole, 10a, pc borad & qc terminal
jqx-14ff61hs etc1 [list of unclassified manufacturers], single-pole, 10a, pc borad & qc terminal
jqx-14ff61znll etc1 [list of unclassified manufacturers], single-pole, 10a, pc borad & qc terminal
jqx-14ff61zqc etc1 [list of unclassified manufacturers], single-pole, 10a, pc borad & qc terminal
jqx-14ff61zs etc1 [list of unclassified manufacturers], single-pole, 10a, pc borad & qc terminal
jqx-14ff91hnll etc1 [list of unclassified manufacturers], single-pole, 10a, pc borad & qc terminal
jqx-14ff91hqc etc1 [list of unclassified manufacturers], single-pole, 10a, pc borad & qc terminal
jqx-14ff91hs etc1 [list of unclassified manufacturers], single-pole, 10a, pc borad & qc terminal
jqx-14ff91znll etc1 [list of unclassified manufacturers], single-pole, 10a, pc borad & qc terminal
jqx-14ff91zqc etc1 [list of unclassified manufacturers], single-pole, 10a, pc borad & qc terminal
jqx-14ff91zs etc1 [list of unclassified manufacturers], single-pole, 10a, pc borad & qc terminal
jqx-14fl-1c-12vdc -, количество в упаковке: 10 шт
jqx-14fw etc1 [list of unclassified manufacturers], single-pole, 20a, pc board
jqx-14fw12dnllnll etc1 [list of unclassified manufacturers], single-pole, 20a, pc board
jqx-14fw12dnllp etc1 [list of unclassified manufacturers], single-pole, 20a, pc board
jqx-14fw12dsnll etc1 [list of unclassified manufacturers], single-pole, 20a, pc board
jqx-14fw12dsp etc1 [list of unclassified manufacturers], single-pole, 20a, pc board

jqx-14fw12hnilnil etc1 [list of unclassified manufacturers], single-pole, 20a, pc board
jqx-14fw12hnilp etc1 [list of unclassified manufacturers], single-pole, 20a, pc board
jqx-14fw12hsnil etc1 [list of unclassified manufacturers], single-pole, 20a, pc board
jqx-14fw12hsp etc1 [list of unclassified manufacturers], single-pole, 20a, pc board
jqx-14fw12znilnil etc1 [list of unclassified manufacturers], single-pole, 20a, pc board
jqx-14fw12znilp etc1 [list of unclassified manufacturers], single-pole, 20a, pc board
jqx-14fw12zsnil etc1 [list of unclassified manufacturers], single-pole, 20a, pc board
jqx-14fw12zsp etc1 [list of unclassified manufacturers], single-pole, 20a, pc board
jqx-14fw18dnilnil etc1 [list of unclassified manufacturers], single-pole, 20a, pc board
jqx-14fw18dnilp etc1 [list of unclassified manufacturers], single-pole, 20a, pc board
jqx-14fw18dsnil etc1 [list of unclassified manufacturers], single-pole, 20a, pc board
jqx-14fw18dsp etc1 [list of unclassified manufacturers], single-pole, 20a, pc board
jqx-14fw18hnilnil etc1 [list of unclassified manufacturers], single-pole, 20a, pc board
jqx-14fw18hnilp etc1 [list of unclassified manufacturers], single-pole, 20a, pc board
jqx-14fw18hsnil etc1 [list of unclassified manufacturers], single-pole, 20a, pc board
jqx-14fw18hsp etc1 [list of unclassified manufacturers], single-pole, 20a, pc board
jqx-14fw18znilnil etc1 [list of unclassified manufacturers], single-pole, 20a, pc board
jqx-14fw18znilp etc1 [list of unclassified manufacturers], single-pole, 20a, pc board
jqx-14fw18zsnil etc1 [list of unclassified manufacturers], single-pole, 20a, pc board
jqx-14fw18zsp etc1 [list of unclassified manufacturers], single-pole, 20a, pc board
jqx-14fw24dnilnil etc1 [list of unclassified manufacturers], single-pole, 20a, pc board
jqx-14fw24dnilp etc1 [list of unclassified manufacturers], single-pole, 20a, pc board
jqx-14fw24dsnil etc1 [list of unclassified manufacturers], single-pole, 20a, pc board
jqx-14fw24dsp etc1 [list of unclassified manufacturers], single-pole, 20a, pc board
jqx-14fw24hnilnil etc1 [list of unclassified manufacturers], single-pole, 20a, pc board
jqx-14fw24hnilp etc1 [list of unclassified manufacturers], single-pole, 20a, pc board
jqx-14fw24hsnil etc1 [list of unclassified manufacturers], single-pole, 20a, pc board
jqx-14fw24hsp etc1 [list of unclassified manufacturers], single-pole, 20a, pc board

jqx-14fw24znilnil etc1 [list of unclassified manufacturers], single-pole, 20a, pc board
jqx-14fw24znilp etc1 [list of unclassified manufacturers], single-pole, 20a, pc board
jqx-14fw24zsniletc1 [list of unclassified manufacturers], single-pole, 20a, pc board
jqx-14fw24zsp etc1 [list of unclassified manufacturers], single-pole, 20a, pc board
jqx-14fw48dnlnil etc1 [list of unclassified manufacturers], single-pole, 20a, pc board
jqx-14fw48dnilp etc1 [list of unclassified manufacturers], single-pole, 20a, pc board
jqx-14fw48dsnil etc1 [list of unclassified manufacturers], single-pole, 20a, pc board
jqx-14fw48dsp etc1 [list of unclassified manufacturers], single-pole, 20a, pc board
jqx-14fw48hlnilnil etc1 [list of unclassified manufacturers], single-pole, 20a, pc board
jqx-14fw48hlnilp etc1 [list of unclassified manufacturers], single-pole, 20a, pc board
jqx-14fw48hsnil etc1 [list of unclassified manufacturers], single-pole, 20a, pc board
jqx-14fw48hsp etc1 [list of unclassified manufacturers], single-pole, 20a, pc board
jqx-14fw48znilnil etc1 [list of unclassified manufacturers], single-pole, 20a, pc board
jqx-14fw48znilp etc1 [list of unclassified manufacturers], single-pole, 20a, pc board
jqx-14fw48zsniletc1 [list of unclassified manufacturers], single-pole, 20a, pc board
jqx-14fw48zsp etc1 [list of unclassified manufacturers], single-pole, 20a, pc board
jqx-14fw5dnlnilnil etc1 [list of unclassified manufacturers], single-pole, 20a, pc board
jqx-14fw5dnilp etc1 [list of unclassified manufacturers], single-pole, 20a, pc board
jqx-14fw5dsnil etc1 [list of unclassified manufacturers], single-pole, 20a, pc board
jqx-14fw5dsp etc1 [list of unclassified manufacturers], single-pole, 20a, pc board
jqx-14fw5hlnilnil etc1 [list of unclassified manufacturers], single-pole, 20a, pc board
jqx-14fw5hlnilp etc1 [list of unclassified manufacturers], single-pole, 20a, pc board
jqx-14fw5hsnil etc1 [list of unclassified manufacturers], single-pole, 20a, pc board
jqx-14fw5hsp etc1 [list of unclassified manufacturers], single-pole, 20a, pc board
jqx-14fw5znilniletc1 [list of unclassified manufacturers], single-pole, 20a, pc board
jqx-14fw5znilp etc1 [list of unclassified manufacturers], single-pole, 20a, pc board
jqx-14fw5zsniletc1 [list of unclassified manufacturers], single-pole, 20a, pc board
jqx-14fw5zsp etc1 [list of unclassified manufacturers], single-pole, 20a, pc board

jqx-14fw60dnlnil etc1 [list of unclassified manufacturers], single-pole, 20a, pc board
jqx-14fw60dnlp etc1 [list of unclassified manufacturers], single-pole, 20a, pc board
jqx-14fw60dsnil etc1 [list of unclassified manufacturers], single-pole, 20a, pc board
jqx-14fw60dsp etc1 [list of unclassified manufacturers], single-pole, 20a, pc board
jqx-14fw60hlnlnil etc1 [list of unclassified manufacturers], single-pole, 20a, pc board
jqx-14fw60hlnlp etc1 [list of unclassified manufacturers], single-pole, 20a, pc board
jqx-14fw60hsnil etc1 [list of unclassified manufacturers], single-pole, 20a, pc board
jqx-14fw60hsp etc1 [list of unclassified manufacturers], single-pole, 20a, pc board
jqx-14fw60zlnlnil etc1 [list of unclassified manufacturers], single-pole, 20a, pc board
jqx-14fw60zlnlp etc1 [list of unclassified manufacturers], single-pole, 20a, pc board
jqx-14fw60zsnil etc1 [list of unclassified manufacturers], single-pole, 20a, pc board
jqx-14fw60zsp etc1 [list of unclassified manufacturers], single-pole, 20a, pc board
jqx-14fw6dnlnlnil etc1 [list of unclassified manufacturers], single-pole, 20a, pc board
jqx-14fw6dnlp etc1 [list of unclassified manufacturers], single-pole, 20a, pc board
jqx-14fw6dsnil etc1 [list of unclassified manufacturers], single-pole, 20a, pc board
jqx-14fw6dsp etc1 [list of unclassified manufacturers], single-pole, 20a, pc board
jqx-14fw6hlnlnlnil etc1 [list of unclassified manufacturers], single-pole, 20a, pc board
jqx-14fw6hlnlp etc1 [list of unclassified manufacturers], single-pole, 20a, pc board
jqx-14fw6hsnil etc1 [list of unclassified manufacturers], single-pole, 20a, pc board
jqx-14fw6hsp etc1 [list of unclassified manufacturers], single-pole, 20a, pc board
jqx-14fw6zlnlnil etc1 [list of unclassified manufacturers], single-pole, 20a, pc board
jqx-14fw6zlnlp etc1 [list of unclassified manufacturers], single-pole, 20a, pc board
jqx-14fw6zsnil etc1 [list of unclassified manufacturers], single-pole, 20a, pc board
jqx-14fw6zsp etc1 [list of unclassified manufacturers], single-pole, 20a, pc board
jqx-14fw9dnlnlnil etc1 [list of unclassified manufacturers], single-pole, 20a, pc board
jqx-14fw9dnlp etc1 [list of unclassified manufacturers], single-pole, 20a, pc board
jqx-14fw9dsnil etc1 [list of unclassified manufacturers], single-pole, 20a, pc board
jqx-14fw9dsp etc1 [list of unclassified manufacturers], single-pole, 20a, pc board

jqx-14fw9hnilnil etc1 [list of unclassified manufacturers], single-pole, 20a, pc board

jqx-14fw9hnilp etc1 [list of unclassified manufacturers], single-pole, 20a, pc board

jqx-14fw9hsnil etc1 [list of unclassified manufacturers], single-pole, 20a, pc board

jqx-14fw9hsp etc1 [list of unclassified manufacturers], single-pole, 20a, pc board

jqx-14fw9znlnil etc1 [list of unclassified manufacturers], single-pole, 20a, pc board

jqx-14fw9znlp etc1 [list of unclassified manufacturers], single-pole, 20a, pc board

jqx-14fw9zsnil etc1 [list of unclassified manufacturers], single-pole, 20a, pc board

jqx-14fw9zsp etc1 [list of unclassified manufacturers], single-pole, 20a, pc board

jqx-15f

jqx-15f-24vdc-c hwe, группа: реле, описание: 277vac / 28vdc, 20a, 30a, габариты: 32x27x20мм

jqx-15f-l-12v жи°екћ, dip 2010

jqx-15f-l-dc12v жи°екћ, dip 2010

jqx-29f-1c-12vdc wanjia electric

jqx-29f-1c-12vdc

jqx-29f-1c-24vdc wanjia electric

jqx-30f-1c-12vdc wanjia electric

jqx-30f-2c-12vdc группа: реле, описание: тип контактов: 2с; икатушки: 12в; ікомм: 30а, габариты: 38x36x48мм

jqx-30f-2c-220vac

jqx-37f реле

jqx-37f0051h реле

jqx-37f0051ht реле

jqx-37f0061h реле

jqx-37f0061ht реле

jqx-37f0091h реле

jqx-37f0091ht реле

jqx-37f0121h реле

jqx-37f0121ht реле

jqx-37f0241h реле

jqx-37f0241ht реле

jqx-37f0481h реле

jqx-37f0481ht реле

jqx-37f0601h реле

jqx-37f0601ht реле

jqx-38fa-12v

jqx-40f-2z-ac220v

jqx-52f-1c-220vac wanjia electric

jqx-54fe реле

jqx-54fe/12h3nil реле

jqx-54fe/12h3t реле

jqx-54fe/24h3nil реле

jqx-54fe/24h3t реле

jqx-54fe/48h3nil реле

jqx-54fe/48h3t реле

jqx-54fe/5h3nil реле

jqx-54fe/5h3t реле

jqx-54fe/6h3nil реле

jqx-54fe/6h3t реле

jqx-54feaz20bdc12vc dblectro [db lectro inc], compact high capacity relay for inductive load, rushing current of 70a and steady-state current of 20a.

jqx-54feaz20bdc24vc dblectro [db lectro inc], compact high capacity relay for inductive load, rushing current of 70a and steady-state current of 20a.

jqx-54feaz20bdc48vc dblectro [db lectro inc], compact high capacity relay for inductive load, rushing current of 70a and steady-state current of 20a.

jqx-54feaz20bdc6vc dblectro [db lectro inc], compact high capacity relay for inductive load, rushing current of 70a and steady-state current of 20a.

jqx-54feaz20bdc9vc dblectro [db lectro inc], compact high capacity relay for inductive load, rushing current of 70a and steady-state current of 20a.

jqx-54feaz250bdc12vc dblectro [db lectro inc], compact high capacity relay for inductive load, rushing current of 70a and steady-state current of 20a.

jqx-54feaz250bdc24vc dblectro [db lectro inc], compact high capacity relay for inductive load, rushing current of 70a and steady-state current of 20a.

jqx-54feaz250bdc48vc dblectro [db lectro inc], compact high capacity relay for inductive load, rushing current of 70a and steady-state current of 20a.

jqx-54feaz250bdc6vc dblectro [db lectro inc], compact high capacity relay for inductive load, rushing current of 70a and steady-state current of 20a.

jqx-54feaz250bdc9vc dblectro [db lectro inc], compact high capacity relay for inductive load, rushing current of 70a and steady-state current of 20a.

jqx-54feaz25bdc12vc dblectro [db lectro inc], compact high capacity relay for inductive load, rushing current of 70a and steady-state current of 20a.

jqx-54feaz25bdc24vc dblectro [db lectro inc], compact high capacity relay for inductive load, rushing current of 70a and steady-state current of 20a.

jqx-54feaz25bdc48vc dblectro [db lectro inc], compact high capacity relay for inductive load, rushing current of 70a and steady-state current of 20a.

jqx-54feaz25bdc6vc dblectro [db lectro inc], compact high capacity relay for inductive load, rushing current of 70a and steady-state current of 20a.

jqx-54feaz25bdc9vc dblectro [db lectro inc], compact high capacity relay for inductive load, rushing current of 70a and steady-state current of 20a.

jqx-54feaz277bdc12vc dblectro [db lectro inc], compact high capacity relay for inductive load, rushing current of 70a and steady-state current of 20a.

jqx-54feaz277bdc24vc dblectro [db lectro inc], compact high capacity relay for inductive load, rushing current of 70a and steady-state current of 20a.

jqx-54feaz277bdc48vc dblectro [db lectro inc], compact high capacity relay for inductive load, rushing current of 70a and steady-state current of 20a.

jqx-54feaz277bdc6vc dblectro [db lectro inc], compact high capacity relay for inductive load, rushing current of 70a and steady-state current of 20a.

jqx-54feaz277bdc9vc dblectro [db lectro inc], compact high capacity relay for inductive load, rushing current of 70a and steady-state current of 20a.

jqx-54w реле,

jqx-54wa20dc110vcb реле,

jqx-54wa20dc110vcf реле,

jqx-54wa20dc12vcb реле,

jqx-54wa20dc12vcf реле,

jqx-54wa20dc24vcb реле,

jqx-54wa20dc24vcf реле,
jqx-54wa20dc48vcb реле,
jqx-54wa20dc48vcf реле,
jqx-54wa20dc5vcb реле,
jqx-54wa20dc5vcf реле,
jqx-54wa20dc6vcb реле,
jqx-54wa20dc6vcf реле,
jqx-54wa20dc9vcb реле,
jqx-54wa20dc9vcf реле,
jqx-54wa250dc110vcb реле,
jqx-54wa250dc110vcf реле,
jqx-54wa250dc12vcb реле,
jqx-54wa250dc12vcf реле,
jqx-54wa250dc24vcb реле,
jqx-54wa250dc24vcf реле,
jqx-54wa250dc48vcb реле,
jqx-54wa250dc48vcf реле,
jqx-54wa250dc5vcb реле,
jqx-54wa250dc5vcf реле,
jqx-54wa250dc6vcb реле,
jqx-54wa250dc6vcf реле,
jqx-54wa250dc9vcb реле,
jqx-54wa250dc9vcf реле,
jqx-54wa25dc110vcb реле,
jqx-54wa25dc110vcf реле,
jqx-54wa25dc12vcb реле,
jqx-54wa25dc12vcf реле,
jqx-54wa25dc24vcb реле,

jqx-54wa25dc24vcf	реле,
jqx-54wa25dc48vcb	реле,
jqx-54wa25dc48vcf	реле,
jqx-54wa25dc5vcb	реле,
jqx-54wa25dc5vcf	реле,
jqx-54wa25dc6vcb	реле,
jqx-54wa25dc6vcf	реле,
jqx-54wa25dc9vcb	реле,
jqx-54wa25dc9vcf	реле,
jqx-54wa277dc110vcb	реле,
jqx-54wa277dc110vcf	реле,
jqx-54wa277dc12vcb	реле,
jqx-54wa277dc12vcf	реле,
jqx-54wa277dc24vcb	реле,
jqx-54wa277dc24vcf	реле,
jqx-54wa277dc48vcb	реле,
jqx-54wa277dc48vcf	реле,
jqx-54wa277dc5vcb	реле,
jqx-54wa277dc5vcf	реле,
jqx-54wa277dc6vcb	реле,
jqx-54wa277dc6vcf	реле,
jqx-54wa277dc9vcb	реле,
jqx-54wa277dc9vcf	реле,
jqx-58f-1c-12vdc pbf	wanjia electric
jqx-59f-1z-80a-220vac	wanjia electric
jqx-62-1c-12vdc	wanjia electric
jqx-62-1c-12vdc pbf	wanjia electric
jqx-62f	реле

jqx-62f-2c-12vdc	wanjia electric
jqx-62f/0051hf	реле
jqx-62f/0051hnil	реле
jqx-62f/0061hf	реле
jqx-62f/0061hnil	реле
jqx-62f/0091hf	реле
jqx-62f/0091hnil	реле
jqx-62f/0121hf	реле
jqx-62f/0121hnil	реле
jqx-62f/0181hf	реле
jqx-62f/0181hnil	реле
jqx-62f/0241hf	реле
jqx-62f/0241hnil	реле
jqx-62f/0481hf	реле
jqx-62f/0481hnil	реле
jqx-62faz16cdc12v	реле, .
jqx-62faz16cdc18v	реле, .
jqx-62faz16cdc24v	реле, .
jqx-62faz16cdc48v	реле, .
jqx-62faz16cdc5v	реле, .
jqx-62faz16cdc6v	реле, .
jqx-62faz16cdc9v	реле, .
jqx-62faz16dc12v	реле, .
jqx-62faz16dc18v	реле, .
jqx-62faz16dc24v	реле, .
jqx-62faz16dc48v	реле, .
jqx-62faz16dc5v	реле, .
jqx-62faz16dc6v	реле, .

jqx-62faz16dc9v	реле, .
jqx-62faz20cdc12v	реле, .
jqx-62faz20cdc18v	реле, .
jqx-62faz20cdc24v	реле, .
jqx-62faz20cdc48v	реле, .
jqx-62faz20cdc5v	реле, .
jqx-62faz20cdc6v	реле, .
jqx-62faz20cdc9v	реле, .
jqx-62faz20dc12v	реле, .
jqx-62faz20dc18v	реле, .
jqx-62faz20dc24v	реле, .
jqx-62faz20dc48v	реле, .
jqx-62faz20dc5v	реле, .
jqx-62faz20dc6v	реле, .
jqx-62faz20dc9v	реле, .
jqx-68	реле
jqx-68f	реле
jqx-68f-006-1hs-551	glenair
jqx-68f-012-1zs-551	glenair
jqx-68f-012-1zsb-555	glenair
jqx-68f-024-1zs hongfa, dip 2010	
jqx-68f-024-1zs-551	glenair
jqx-68f-024-1zsb-555	glenair
jqx-68f-12v-1zs hongfa, dip 2011	
jqx-68f-12vdc-1zs	hongfa, dip 2011
jqx-68f-1zs-12v hongfa, dip 2011	
jqx-68f-1zs-12vdc	hongfa, dip 2011
jqx-68f-1zs-24v hongfa, dip 2011	

jqx-68f-1zs-24vdc hongfa, dip 2011

jqx-68f-24v-1zs hongfa, dip 2011

jqx-68f-24vdc-1zs hongfa, dip 2011

jqx115-f etc1 [list of unclassified manufacturers], 16a 1 pole pc board type

jqx115-f-i etc1 [list of unclassified manufacturers], 16a 1 pole pc board type

jqx115f0121hs3 glenair

jqx115f024-2zs4 hongfa relay, jqx115f024-2zs4 miniature electromagnetic relays

jqx115f110vdc

jqx13f-1c-a-dc24v-1 группа: реле, описание: тип контактов:1с; катушки:24b; икомм: 20а

jqx13f-2c-a-dc12v-1 группа: реле, описание: тип контактов:2с; катушки:12b; икомм:10а

jqx14-ffetc1 [list of unclassified manufacturers], single-pole, 10a, pc board & qc terminal

s-8354a38mc-jqxt2g seiko instruments, импульсные контроллеры постоянного тока (dc/dc) step-up swr pwm 18.7ua iq

wj175-3z socket [jqx-38fa] wanjia electric

acvx1220-freq-l-j-qxx abracon

dsl3510l sljqx intel, ис, контроллер интерфейса ввода вывода thunderbolt - 4 ch controller fc-csp288

hhc68a(jqx-13f)-2z-24vdc glenair, available

jqx-102f реле

jqx-102f/012 hongfa, dip 2006

jqx-102f005 реле

jqx-102f012 реле

jqx-102f024 реле

jqx-102f048 реле

jqx-102faz20bdc12c0.9 реле

jqx-102faz20bdc12v0.9 dblectro [db lectro inc], used household appliance like air conditioning

jqx-102faz20bdc24c0.9 реле

jqx-102faz20bdc24v0.9 dblectro [db lectro inc], used household appliance like air conditioning

jqx-102faz20bdc48c0.9 реле

jqx-102faz20bdc48v0.9 dblectro [db lectro inc], used household appliance like air conditioning

jqx-102faz20bdc5c0.9 реле

jqx-102faz20bdc5v0.9 dblectro [db lectro inc], used household appliance like air conditioning

jqx-102faz20nildc12v0.9 dblectro [db lectro inc], used household appliance like air conditioning

jqx-102faz20nildc24v0.9 dblectro [db lectro inc], used household appliance like air conditioning

jqx-102faz20nildc48v0.9 dblectro [db lectro inc], used household appliance like air conditioning

jqx-102faz20nildc5v0.9 dblectro [db lectro inc], used household appliance like a air conditioning

jqx-102faz250bdc12c0.9 реле

jqx-102faz250bdc24c0.9 реле

jqx-102faz250bdc48c0.9 реле

jqx-102faz250bdc5c0.9 реле

jqx-102fp005 реле

jqx-102fp012 реле

jqx-102fp024 реле

jqx-102fp048 реле

jqx-102fpt005 реле

jqx-102fpt012 реле

jqx-102fpt024 реле

jqx-102fpt048 реле

jqx-102ft005 реле

jqx-102ft012 реле

jqx-102ft024 реле

jqx-102ft048 реле

jqx-102f_05 реле

jqx-105-4lack1dnil реле

jqx-105-4lack1ds реле

jqx-105-4lack1hnil реле

jqx-105-4lack1hs реле

jqx-105-4lack1znil реле

jqx-105-4lack1zs	реле	
jqx-105-4lacnil1dnil	реле	
jqx-105-4lacnil1ds	реле	
jqx-105-4lacnil1hnil	реле	
jqx-105-4lacnil1hs	реле	
jqx-105-4lacnil1znil	реле	
jqx-105-4lacnil1zs	реле	
jqx-105-4ldck1dnil	реле	
jqx-105-4ldck1ds	реле	
jqx-105-4ldck1hnil	реле	
jqx-105-4ldck1hs	реле	
jqx-105-4ldck1znil	реле	
jqx-105-4ldck1zs	реле	
jqx-105-4ldcnil1dnil	реле	
jqx-105-4ldcnil1ds	реле	
jqx-105-4ldcnil1hnil	реле	
jqx-105-4ldcnil1hs	реле	
jqx-105-4ldcnil1znil	реле	
jqx-105-4ldcnil1zs	реле	
jqx-105f-1	реле	
jqx-105f-1-012-d1hst-555		glenair
jqx-105f-1018a61dstf	реле	
jqx-105f-1018a61hstf	реле	
jqx-105f-1018a61zstf	реле	
jqx-105f-1018at1dstf	реле	
jqx-105f-1018at1hstf	реле	
jqx-105f-1018at1zstf	реле	
jqx-105f-1018d61dstf	реле	

jqx-105f-1018d61hstf реле
jqx-105f-1018d61zstf реле
jqx-105f-1018dt1dstf реле
jqx-105f-1018dt1hstf реле
jqx-105f-1018dt1zstf реле
jqx-105f-2 etc1 [list of unclassified manufacturers], 30a pole pcb&qc terminal
jqx-105f-2l etc1 [list of unclassified manufacturers], 30a pole pcb&qc terminal
jqx-105f-4 реле
jqx-105f-4/005d1d реле
jqx-105f-4/005d1df реле
jqx-105f-4/005d1dt реле
jqx-105f-4/005d1dtf реле
jqx-105f-4/005d1h реле
jqx-105f-4/005d1hf реле
jqx-105f-4/005d1ht реле
jqx-105f-4/005d1htf реле
jqx-105f-4/005d1z реле
jqx-105f-4/005d1zf реле
jqx-105f-4/005d1zt реле
jqx-105f-4/005d1ztf реле
jqx-105f-4/005dk1d реле
jqx-105f-4/005dk1df реле
jqx-105f-4/005dk1dt реле
jqx-105f-4/005dk1dtf реле
jqx-105f-4/005dk1h реле
jqx-105f-4/005dk1hf реле
jqx-105f-4/005dk1ht реле
jqx-105f-4/005dk1htf реле

jqx-105f-4/005dk1z	реле
jqx-105f-4/005dk1zf	реле
jqx-105f-4/005dk1zt	реле
jqx-105f-4/005dk1ztf	реле
jqx-105f-4/009d1d	реле
jqx-105f-4/009d1df	реле
jqx-105f-4/009d1dt	реле
jqx-105f-4/009d1dtf	реле
jqx-105f-4/009d1h	реле
jqx-105f-4/009d1hf	реле
jqx-105f-4/009d1ht	реле
jqx-105f-4/009d1htf	реле
jqx-105f-4/009d1z	реле
jqx-105f-4/009d1zf	реле
jqx-105f-4/009d1zt	реле
jqx-105f-4/009d1ztf	реле
jqx-105f-4/009dk1d	реле
jqx-105f-4/009dk1df	реле
jqx-105f-4/009dk1dt	реле
jqx-105f-4/009dk1dtf	реле
jqx-105f-4/009dk1h	реле
jqx-105f-4/009dk1hf	реле
jqx-105f-4/009dk1ht	реле
jqx-105f-4/009dk1htf	реле
jqx-105f-4/009dk1z	реле
jqx-105f-4/009dk1zf	реле
jqx-105f-4/009dk1zt	реле
jqx-105f-4/009dk1ztf	реле

jqx-105f-4/012a1d	реле
jqx-105f-4/012a1df	реле
jqx-105f-4/012a1dt	реле
jqx-105f-4/012a1dtf	реле
jqx-105f-4/012a1h	реле
jqx-105f-4/012a1hf	реле
jqx-105f-4/012a1ht	реле
jqx-105f-4/012a1htf	реле
jqx-105f-4/012a1z	реле
jqx-105f-4/012a1zf	реле
jqx-105f-4/012a1zt	реле
jqx-105f-4/012a1ztf	реле
jqx-105f-4/012ak1d	реле
jqx-105f-4/012ak1df	реле
jqx-105f-4/012ak1dt	реле
jqx-105f-4/012ak1dtf	реле
jqx-105f-4/012ak1h	реле
jqx-105f-4/012ak1hf	реле
jqx-105f-4/012ak1ht	реле
jqx-105f-4/012ak1htf	реле
jqx-105f-4/012ak1z	реле
jqx-105f-4/012ak1zf	реле
jqx-105f-4/012ak1zt	реле
jqx-105f-4/012ak1ztf	реле
jqx-105f-4/018d1d	реле
jqx-105f-4/018d1df	реле
jqx-105f-4/018d1dt	реле
jqx-105f-4/018d1dtf	реле

jqx-105f-4/018d1h	реле
jqx-105f-4/018d1hf	реле
jqx-105f-4/018d1ht	реле
jqx-105f-4/018d1htf	реле
jqx-105f-4/018d1z	реле
jqx-105f-4/018d1zf	реле
jqx-105f-4/018d1zt	реле
jqx-105f-4/018d1ztf	реле
jqx-105f-4/018dk1d	реле
jqx-105f-4/018dk1df	реле
jqx-105f-4/018dk1dt	реле
jqx-105f-4/018dk1dtf	реле
jqx-105f-4/018dk1h	реле
jqx-105f-4/018dk1hf	реле
jqx-105f-4/018dk1ht	реле
jqx-105f-4/018dk1htf	реле
jqx-105f-4/018dk1z	реле
jqx-105f-4/018dk1zf	реле
jqx-105f-4/018dk1zt	реле
jqx-105f-4/018dk1ztf	реле
jqx-105f-4/024a1d	реле
jqx-105f-4/024a1df	реле
jqx-105f-4/024a1dt	реле
jqx-105f-4/024a1dtf	реле
jqx-105f-4/024a1h	реле
jqx-105f-4/024a1hf	реле
jqx-105f-4/024a1ht	реле
jqx-105f-4/024a1htf	реле

jqx-105f-4/024a1z	реле
jqx-105f-4/024a1zf	реле
jqx-105f-4/024a1zt	реле
jqx-105f-4/024a1ztf	реле
jqx-105f-4/024ak1d	реле
jqx-105f-4/024ak1df	реле
jqx-105f-4/024ak1dt	реле
jqx-105f-4/024ak1dtf	реле
jqx-105f-4/024ak1h	реле
jqx-105f-4/024ak1hf	реле
jqx-105f-4/024ak1ht	реле
jqx-105f-4/024ak1htf	реле
jqx-105f-4/024ak1z	реле
jqx-105f-4/024ak1zf	реле
jqx-105f-4/024ak1zt	реле
jqx-105f-4/024ak1ztf	реле
jqx-105f-4/048d1d	реле
jqx-105f-4/048d1df	реле
jqx-105f-4/048d1dt	реле
jqx-105f-4/048d1dtf	реле
jqx-105f-4/048d1h	реле
jqx-105f-4/048d1hf	реле
jqx-105f-4/048d1ht	реле
jqx-105f-4/048d1htf	реле
jqx-105f-4/048d1z	реле
jqx-105f-4/048d1zf	реле
jqx-105f-4/048d1zt	реле
jqx-105f-4/048d1ztf	реле

jqx-105f-4/048dk1d	реле
jqx-105f-4/048dk1df	реле
jqx-105f-4/048dk1dt	реле
jqx-105f-4/048dk1dtf	реле
jqx-105f-4/048dk1h	реле
jqx-105f-4/048dk1hf	реле
jqx-105f-4/048dk1ht	реле
jqx-105f-4/048dk1htf	реле
jqx-105f-4/048dk1z	реле
jqx-105f-4/048dk1zf	реле
jqx-105f-4/048dk1zt	реле
jqx-105f-4/048dk1ztf	реле
jqx-105f-4/070d1d	реле
jqx-105f-4/070d1df	реле
jqx-105f-4/070d1dt	реле
jqx-105f-4/070d1dtf	реле
jqx-105f-4/070d1h	реле
jqx-105f-4/070d1hf	реле
jqx-105f-4/070d1ht	реле
jqx-105f-4/070d1htf	реле
jqx-105f-4/070d1z	реле
jqx-105f-4/070d1zf	реле
jqx-105f-4/070d1zt	реле
jqx-105f-4/070d1ztf	реле
jqx-105f-4/070dk1d	реле
jqx-105f-4/070dk1df	реле
jqx-105f-4/070dk1dt	реле
jqx-105f-4/070dk1dtf	реле

jqx-105f-4/070dk1h	реле
jqx-105f-4/070dk1hf	реле
jqx-105f-4/070dk1ht	реле
jqx-105f-4/070dk1htf	реле
jqx-105f-4/070dk1z	реле
jqx-105f-4/070dk1zf	реле
jqx-105f-4/070dk1zt	реле
jqx-105f-4/070dk1ztf	реле
jqx-105f-4/110d1d	реле
jqx-105f-4/110d1df	реле
jqx-105f-4/110d1dt	реле
jqx-105f-4/110d1dtf	реле
jqx-105f-4/110d1h	реле
jqx-105f-4/110d1hf	реле
jqx-105f-4/110d1ht	реле
jqx-105f-4/110d1htf	реле
jqx-105f-4/110d1z	реле
jqx-105f-4/110d1zf	реле
jqx-105f-4/110d1zt	реле
jqx-105f-4/110d1ztf	реле
jqx-105f-4/110dk1d	реле
jqx-105f-4/110dk1df	реле
jqx-105f-4/110dk1dt	реле
jqx-105f-4/110dk1dtf	реле
jqx-105f-4/110dk1h	реле
jqx-105f-4/110dk1hf	реле
jqx-105f-4/110dk1ht	реле
jqx-105f-4/110dk1htf	реле

jqx-105f-4/110dk1z	реле
jqx-105f-4/110dk1zf	реле
jqx-105f-4/110dk1zt	реле
jqx-105f-4/110dk1ztf	реле
jqx-105f-4/120a1d	реле
jqx-105f-4/120a1df	реле
jqx-105f-4/120a1dt	реле
jqx-105f-4/120a1dtf	реле
jqx-105f-4/120a1h	реле
jqx-105f-4/120a1hf	реле
jqx-105f-4/120a1ht	реле
jqx-105f-4/120a1htf	реле
jqx-105f-4/120a1z	реле
jqx-105f-4/120a1zf	реле
jqx-105f-4/120a1zt	реле
jqx-105f-4/120a1ztf	реле
jqx-105f-4/120ak1d	реле
jqx-105f-4/120ak1df	реле
jqx-105f-4/120ak1dt	реле
jqx-105f-4/120ak1dtf	реле
jqx-105f-4/120ak1h	реле
jqx-105f-4/120ak1hf	реле
jqx-105f-4/120ak1ht	реле
jqx-105f-4/120ak1htf	реле
jqx-105f-4/120ak1z	реле
jqx-105f-4/120ak1zf	реле
jqx-105f-4/120ak1zt	реле
jqx-105f-4/120ak1ztf	реле

jqx-105f-4/277a1d	реле
jqx-105f-4/277a1df	реле
jqx-105f-4/277a1dt	реле
jqx-105f-4/277a1dtf	реле
jqx-105f-4/277a1h	реле
jqx-105f-4/277a1hf	реле
jqx-105f-4/277a1ht	реле
jqx-105f-4/277a1htf	реле
jqx-105f-4/277a1z	реле
jqx-105f-4/277a1zf	реле
jqx-105f-4/277a1zt	реле
jqx-105f-4/277a1ztf	реле
jqx-105f-4/277ak1d	реле
jqx-105f-4/277ak1df	реле
jqx-105f-4/277ak1dt	реле
jqx-105f-4/277ak1dtf	реле
jqx-105f-4/277ak1h	реле
jqx-105f-4/277ak1hf	реле
jqx-105f-4/277ak1ht	реле
jqx-105f-4/277ak1htf	реле
jqx-105f-4/277ak1z	реле
jqx-105f-4/277ak1zf	реле
jqx-105f-4/277ak1zt	реле
jqx-105f-4/277ak1ztf	реле
jqx-105f-4ack1dnil	реле
jqx-105f-4ack1ds	реле
jqx-105f-4ack1hnil	реле
jqx-105f-4ack1hs	реле

jqx-105f-4ack1znil	реле
jqx-105f-4ack1zs	реле
jqx-105f-4acnil1dnil	реле
jqx-105f-4acnil1ds	реле
jqx-105f-4acnil1hnil	реле
jqx-105f-4acnil1hs	реле
jqx-105f-4acnil1znil	реле
jqx-105f-4acnil1zs	реле
jqx-105f-4dck1dnil	реле
jqx-105f-4dck1ds	реле
jqx-105f-4dck1hnil	реле
jqx-105f-4dck1hs	реле
jqx-105f-4dck1znil	реле
jqx-105f-4dck1zs	реле
jqx-105f-4dcnil1dnil	реле
jqx-105f-4dcnil1ds	реле
jqx-105f-4dcnil1hnil	реле
jqx-105f-4dcnil1hs	реле
jqx-105f-4dcnil1znil	реле
jqx-105f-4dcnil1zs	реле
jqx-105f-4l/005d1d	реле
jqx-105f-4l/005d1df	реле
jqx-105f-4l/005d1dt	реле
jqx-105f-4l/005d1dtf	реле
jqx-105f-4l/005d1h	реле
jqx-105f-4l/005d1hf	реле
jqx-105f-4l/005d1ht	реле
jqx-105f-4l/005d1htf	реле

jqx-105f-4l/005d1z	реле
jqx-105f-4l/005d1zf	реле
jqx-105f-4l/005d1zt	реле
jqx-105f-4l/005d1ztf	реле
jqx-105f-4l/005dk1d	реле
jqx-105f-4l/005dk1df	реле
jqx-105f-4l/005dk1dt	реле
jqx-105f-4l/005dk1dtf	реле
jqx-105f-4l/005dk1h	реле
jqx-105f-4l/005dk1hf	реле
jqx-105f-4l/005dk1ht	реле
jqx-105f-4l/005dk1htf	реле
jqx-105f-4l/005dk1z	реле
jqx-105f-4l/005dk1zf	реле
jqx-105f-4l/005dk1zt	реле
jqx-105f-4l/005dk1ztf	реле
jqx-105f-4l/009d1d	реле
jqx-105f-4l/009d1df	реле
jqx-105f-4l/009d1dt	реле
jqx-105f-4l/009d1dtf	реле
jqx-105f-4l/009d1h	реле
jqx-105f-4l/009d1hf	реле
jqx-105f-4l/009d1ht	реле
jqx-105f-4l/009d1htf	реле
jqx-105f-4l/009d1z	реле
jqx-105f-4l/009d1zf	реле
jqx-105f-4l/009d1zt	реле
jqx-105f-4l/009d1ztf	реле

jqx-105f-4l/009dk1d реле
jqx-105f-4l/009dk1df реле
jqx-105f-4l/009dk1dt реле
jqx-105f-4l/009dk1dtf реле
jqx-105f-4l/009dk1h реле
jqx-105f-4l/009dk1hf реле
jqx-105f-4l/009dk1ht реле
jqx-105f-4l/009dk1htf реле
jqx-105f-4l/009dk1z реле
jqx-105f-4l/009dk1zf реле
jqx-105f-4l/009dk1zt реле
jqx-105f-4l/009dk1ztf реле
jqx-105f-4l/012a1d реле
jqx-105f-4l/012a1df реле
jqx-105f-4l/012a1dt реле
jqx-105f-4l/012a1dtf реле
jqx-105f-4l/012a1h реле
jqx-105f-4l/012a1hf реле
jqx-105f-4l/012a1ht реле
jqx-105f-4l/012a1htf реле
jqx-105f-4l/012a1z реле
jqx-105f-4l/012a1zf реле
jqx-105f-4l/012a1zt реле
jqx-105f-4l/012a1ztf реле
jqx-105f-4l/012ak1d реле
jqx-105f-4l/012ak1df реле
jqx-105f-4l/012ak1dt реле
jqx-105f-4l/012ak1dtf реле

jqx-105f-4l/012ak1h реле
jqx-105f-4l/012ak1hf реле
jqx-105f-4l/012ak1ht реле
jqx-105f-4l/012ak1htf реле
jqx-105f-4l/012ak1z реле
jqx-105f-4l/012ak1zf реле
jqx-105f-4l/012ak1zt реле
jqx-105f-4l/012ak1ztf реле
jqx-105f-4l/018d1d реле
jqx-105f-4l/018d1df реле
jqx-105f-4l/018d1dt реле
jqx-105f-4l/018d1dtf реле
jqx-105f-4l/018d1h реле
jqx-105f-4l/018d1hf реле
jqx-105f-4l/018d1ht реле
jqx-105f-4l/018d1htf реле
jqx-105f-4l/018d1z реле
jqx-105f-4l/018d1zf реле
jqx-105f-4l/018d1zt реле
jqx-105f-4l/018d1ztf реле
jqx-105f-4l/018dk1d реле
jqx-105f-4l/018dk1df реле
jqx-105f-4l/018dk1dt реле
jqx-105f-4l/018dk1dtf реле
jqx-105f-4l/018dk1h реле
jqx-105f-4l/018dk1hf реле
jqx-105f-4l/018dk1ht реле
jqx-105f-4l/018dk1htf реле

jqx-105f-4l/018dk1z реле
jqx-105f-4l/018dk1zf реле
jqx-105f-4l/018dk1zt реле
jqx-105f-4l/018dk1ztf реле
jqx-105f-4l/024a1d реле
jqx-105f-4l/024a1df реле
jqx-105f-4l/024a1dt реле
jqx-105f-4l/024a1dtf реле
jqx-105f-4l/024a1h реле
jqx-105f-4l/024a1hf реле
jqx-105f-4l/024a1ht реле
jqx-105f-4l/024a1htf реле
jqx-105f-4l/024a1z реле
jqx-105f-4l/024a1zf реле
jqx-105f-4l/024a1zt реле
jqx-105f-4l/024a1ztf реле
jqx-105f-4l/024ak1d реле
jqx-105f-4l/024ak1df реле
jqx-105f-4l/024ak1dt реле
jqx-105f-4l/024ak1dtf реле
jqx-105f-4l/024ak1h реле
jqx-105f-4l/024ak1hf реле
jqx-105f-4l/024ak1ht реле
jqx-105f-4l/024ak1htf реле
jqx-105f-4l/024ak1z реле
jqx-105f-4l/024ak1zf реле
jqx-105f-4l/024ak1zt реле
jqx-105f-4l/024ak1ztf реле

jqx-105f-4l/048d1d	реле
jqx-105f-4l/048d1df	реле
jqx-105f-4l/048d1dt	реле
jqx-105f-4l/048d1dtf	реле
jqx-105f-4l/048d1h	реле
jqx-105f-4l/048d1hf	реле
jqx-105f-4l/048d1ht	реле
jqx-105f-4l/048d1htf	реле
jqx-105f-4l/048d1z	реле
jqx-105f-4l/048d1zf	реле
jqx-105f-4l/048d1zt	реле
jqx-105f-4l/048d1ztf	реле
jqx-105f-4l/048dk1d	реле
jqx-105f-4l/048dk1df	реле
jqx-105f-4l/048dk1dt	реле
jqx-105f-4l/048dk1dtf	реле
jqx-105f-4l/048dk1h	реле
jqx-105f-4l/048dk1hf	реле
jqx-105f-4l/048dk1ht	реле
jqx-105f-4l/048dk1htf	реле
jqx-105f-4l/048dk1z	реле
jqx-105f-4l/048dk1zf	реле
jqx-105f-4l/048dk1zt	реле
jqx-105f-4l/048dk1ztf	реле
jqx-105f-4l/070d1d	реле
jqx-105f-4l/070d1df	реле
jqx-105f-4l/070d1dt	реле
jqx-105f-4l/070d1dtf	реле

jqx-105f-4l/070d1h	реле
jqx-105f-4l/070d1hf	реле
jqx-105f-4l/070d1ht	реле
jqx-105f-4l/070d1htf	реле
jqx-105f-4l/070d1z	реле
jqx-105f-4l/070d1zf	реле
jqx-105f-4l/070d1zt	реле
jqx-105f-4l/070d1ztf	реле
jqx-105f-4l/070dk1d	реле
jqx-105f-4l/070dk1df	реле
jqx-105f-4l/070dk1dt	реле
jqx-105f-4l/070dk1dtf	реле
jqx-105f-4l/070dk1h	реле
jqx-105f-4l/070dk1hf	реле
jqx-105f-4l/070dk1ht	реле
jqx-105f-4l/070dk1htf	реле
jqx-105f-4l/070dk1z	реле
jqx-105f-4l/070dk1zf	реле
jqx-105f-4l/070dk1zt	реле
jqx-105f-4l/070dk1ztf	реле
jqx-105f-4l/110d1d	реле
jqx-105f-4l/110d1df	реле
jqx-105f-4l/110d1dt	реле
jqx-105f-4l/110d1dtf	реле
jqx-105f-4l/110d1h	реле
jqx-105f-4l/110d1hf	реле
jqx-105f-4l/110d1ht	реле
jqx-105f-4l/110d1htf	реле

jqx-105f-4l/110d1z	реле
jqx-105f-4l/110d1zf	реле
jqx-105f-4l/110d1zt	реле
jqx-105f-4l/110d1ztf	реле
jqx-105f-4l/110dk1d	реле
jqx-105f-4l/110dk1df	реле
jqx-105f-4l/110dk1dt	реле
jqx-105f-4l/110dk1dtf	реле
jqx-105f-4l/110dk1h	реле
jqx-105f-4l/110dk1hf	реле
jqx-105f-4l/110dk1ht	реле
jqx-105f-4l/110dk1htf	реле
jqx-105f-4l/110dk1z	реле
jqx-105f-4l/110dk1zf	реле
jqx-105f-4l/110dk1zt	реле
jqx-105f-4l/110dk1ztf	реле
jqx-105f-4l/120a1d	реле
jqx-105f-4l/120a1df	реле
jqx-105f-4l/120a1dt	реле
jqx-105f-4l/120a1dtf	реле
jqx-105f-4l/120a1h	реле
jqx-105f-4l/120a1hf	реле
jqx-105f-4l/120a1ht	реле
jqx-105f-4l/120a1htf	реле
jqx-105f-4l/120a1z	реле
jqx-105f-4l/120a1zf	реле
jqx-105f-4l/120a1zt	реле
jqx-105f-4l/120a1ztf	реле

jqx-105f-4l/120ak1d реле
jqx-105f-4l/120ak1df реле
jqx-105f-4l/120ak1dt реле
jqx-105f-4l/120ak1dtf реле
jqx-105f-4l/120ak1h реле
jqx-105f-4l/120ak1hf реле
jqx-105f-4l/120ak1ht реле
jqx-105f-4l/120ak1htf реле
jqx-105f-4l/120ak1z реле
jqx-105f-4l/120ak1zf реле
jqx-105f-4l/120ak1zt реле
jqx-105f-4l/120ak1ztf реле
jqx-105f-4l/277a1d реле
jqx-105f-4l/277a1df реле
jqx-105f-4l/277a1dt реле
jqx-105f-4l/277a1dtf реле
jqx-105f-4l/277a1h реле
jqx-105f-4l/277a1hf реле
jqx-105f-4l/277a1ht реле
jqx-105f-4l/277a1htf реле
jqx-105f-4l/277a1z реле
jqx-105f-4l/277a1zf реле
jqx-105f-4l/277a1zt реле
jqx-105f-4l/277a1ztf реле
jqx-105f-4l/277ak1d реле
jqx-105f-4l/277ak1df реле
jqx-105f-4l/277ak1dt реле
jqx-105f-4l/277ak1dtf реле

jqx-105f-4l/277ak1h	реле
jqx-105f-4l/277ak1hf	реле
jqx-105f-4l/277ak1ht	реле
jqx-105f-4l/277ak1htf	реле
jqx-105f-4l/277ak1z	реле
jqx-105f-4l/277ak1zf	реле
jqx-105f-4l/277ak1zt	реле
jqx-105f-4l/277ak1ztf	реле
jqx-105f-4_04	реле
jqx-105f-5	etc1 [list of unclassified manufacturers], 30a pole board typ
jqx-105f-5l	etc1 [list of unclassified manufacturers], 30a pole board typ
jqx-10ff	реле
jqx-10ff/006a2zd	реле
jqx-10ff/006a2znil	реле
jqx-10ff/006a3z-1d	реле
jqx-10ff/006a3z-1nil	реле
jqx-10ff/006a3zd	реле
jqx-10ff/006a3znil	реле
jqx-10ff/006nil2zd	реле
jqx-10ff/006nil2znil	реле
jqx-10ff/006nil3z-1d	реле
jqx-10ff/006nil3z-1nil	реле
jqx-10ff/006nil3zd	реле
jqx-10ff/006nil3znil	реле
jqx-10ff/012a2zd	реле
jqx-10ff/012a2znil	реле
jqx-10ff/012a3z-1d	реле
jqx-10ff/012a3z-1nil	реле

jqx-10ff/012a3zd	реле
jqx-10ff/012a3znil	реле
jqx-10ff/012nil2zd	реле
jqx-10ff/012nil2znil	реле
jqx-10ff/012nil3z-1d	реле
jqx-10ff/012nil3z-1nil	реле
jqx-10ff/012nil3zd	реле
jqx-10ff/012nil3znil	реле
jqx-10ff/024a2zd	реле
jqx-10ff/024a2znil	реле
jqx-10ff/024a3z-1d	реле
jqx-10ff/024a3z-1nil	реле
jqx-10ff/024a3zd	реле
jqx-10ff/024a3znil	реле
jqx-10ff/024nil2zd	реле
jqx-10ff/024nil2znil	реле
jqx-10ff/024nil3z-1d	реле
jqx-10ff/024nil3z-1nil	реле
jqx-10ff/024nil3zd	реле
jqx-10ff/024nil3znil	реле
jqx-10ff/048a2zd	реле
jqx-10ff/048a2znil	реле
jqx-10ff/048a3z-1d	реле
jqx-10ff/048a3z-1nil	реле
jqx-10ff/048a3zd	реле
jqx-10ff/048a3znil	реле
jqx-10ff/048nil2zd	реле
jqx-10ff/048nil2znil	реле

jqx-10ff/048nil3z-1d	реле
jqx-10ff/048nil3z-1nil	реле
jqx-10ff/048nil3zd	реле
jqx-10ff/048nil3znil	реле
jqx-10ff/100a2zd	реле
jqx-10ff/100a2znil	реле
jqx-10ff/100a3z-1d	реле
jqx-10ff/100a3z-1nil	реле
jqx-10ff/100a3zd	реле
jqx-10ff/100a3znil	реле
jqx-10ff/100nil2zd	реле
jqx-10ff/100nil2znil	реле
jqx-10ff/100nil3z-1d	реле
jqx-10ff/100nil3z-1nil	реле
jqx-10ff/100nil3zd	реле
jqx-10ff/100nil3znil	реле
jqx-10ff/110a2zd	реле
jqx-10ff/110a2znil	реле
jqx-10ff/110a3z-1d	реле
jqx-10ff/110a3z-1nil	реле
jqx-10ff/110a3zd	реле
jqx-10ff/110a3znil	реле
jqx-10ff/110nil2zd	реле
jqx-10ff/110nil2znil	реле
jqx-10ff/110nil3z-1d	реле
jqx-10ff/110nil3z-1nil	реле
jqx-10ff/110nil3zd	реле
jqx-10ff/110nil3znil	реле

jqx-10ff/120a2zd	реле
jqx-10ff/120a2znil	реле
jqx-10ff/120a3z-1d	реле
jqx-10ff/120a3z-1nil	реле
jqx-10ff/120a3zd	реле
jqx-10ff/120a3znil	реле
jqx-10ff/120nil2zd	реле
jqx-10ff/120nil2znil	реле
jqx-10ff/120nil3z-1d	реле
jqx-10ff/120nil3z-1nil	реле
jqx-10ff/120nil3zd	реле
jqx-10ff/120nil3znil	реле
jqx-10ff/220a2zd	реле
jqx-10ff/220a2znil	реле
jqx-10ff/220a3z-1d	реле
jqx-10ff/220a3z-1nil	реле
jqx-10ff/220a3zd	реле
jqx-10ff/220a3znil	реле
jqx-10ff/220nil2zd	реле
jqx-10ff/220nil2znil	реле
jqx-10ff/220nil3z-1d	реле
jqx-10ff/220nil3z-1nil	реле
jqx-10ff/220nil3zd	реле
jqx-10ff/220nil3znil	реле
jqx-10ff/240a2zd	реле
jqx-10ff/240a2znil	реле
jqx-10ff/240a3z-1d	реле
jqx-10ff/240a3z-1nil	реле

jqx-10ff/240a3zd реле

jqx-10ff/240a3znil реле

jqx-10ff/240nil2zd реле

jqx-10ff/240nil2znil реле

jqx-10ff/240nil3z-1d реле

jqx-10ff/240nil3z-1nil реле

jqx-10ff/240nil3zd реле

jqx-10ff/240nil3znil реле

jqx-115 реле

jqx-115-f-i etc1 [list of unclassified manufacturers], 16a pole board typ

jqx-115f реле

jqx-115f-006-1hs3-551 glenair

jqx-115f-012-1hs3-551 glenair

jqx-115f-012-1hs3a(555) glenair

jqx-115f-012-1z1a 555 glenair

jqx-115f-012-1z3a 555 glenair

jqx-115f-012-1zs1 hongfa, dip 2011

jqx-115f-012-1zs3-551 glenair

jqx-115f-012-1zs3a (555) glenair

jqx-115f-012-1zs3b glenair

jqx-115f-012-2zs4

jqx-115f-012-2zs4(551) hongfa electroacoustic co.,ltd., реле средней мощности; ик,а =8; ик,в =250vac; ин,в = 12; р,вт = 0.4; кол. ком. гр. =2; вид конт. группы с; иі/о,в =1000; тэкср, °с -40...+85; тип упр. и дс; вр. сраб. <15ms; тип монт. pcb; 29x12,7x15

jqx-115f-024-1z3 glenair

jqx-115f-024-1z3a-555 glenair

jqx-115f-024-1zs1 hongfa, dip 2011

jqx-115f-024-1zs3(551) hongfa electroacoustic co.,ltd., реле средней мощности; ик,а =16; ик,в =250vac; ин,в = 24; р,вт = 0.4; кол. ком. гр. = 1; вид конт. группы с; иі/о,в = 1000; тэкср, °с -40...+85; тип упр. и дс; вр. сраб. <15ms; тип монт. pcb; 29x12,7

jqx-115f-024-2zs4 glenair

jqx-115f-024-2zs4(551) hongfa electroacoustic co.,ltd., реле средней мощности; ик,а =8; ук,в =250vac; ич,в = 24; р,вт =0.4; кол. ком. гр. =2; вид конт. группы с; иі/о,в =1000; тэкср, °с -40...+85; тип упр. и дс; вр. сраб. <15ms; тип монт. pcb; 29x12,7x15,

jqx-115f-024-2zs4b glenair

jqx-115f-048-2zs4b-610-555 glenair

jqx-115f-i реле

jqx-115f-i0051hs3a реле

jqx-115f-i0061hs3a реле

jqx-115f-i0091hs3a реле

jqx-115f-i0121hs3a реле

jqx-115f-i0181hs3a реле

jqx-115f-i0241hs3a реле

jqx-115f-i0481hs3a реле

jqx-115f-i0601hs3a реле

jqx-115f-i1101hnil3 etc1 [list of unclassified manufacturers], 16a pole board typ

jqx-115f-i1101hs3 etc1 [list of unclassified manufacturers], 16a pole board typ

jqx-115f-i1101hs3a реле

jqx-115f-i121hnil3 etc1 [list of unclassified manufacturers], 16a pole board typ

jqx-115f-i121hs3 etc1 [list of unclassified manufacturers], 16a pole board typ

jqx-115f-i241hnil3 etc1 [list of unclassified manufacturers], 16a pole board typ

jqx-115f-i241hs3 etc1 [list of unclassified manufacturers], 16a pole board typ

jqx-115f-i481hnil3 etc1 [list of unclassified manufacturers], 16a pole board typ

jqx-115f-i481hs3 etc1 [list of unclassified manufacturers], 16a pole board typ

jqx-115f-i51hnil3 etc1 [list of unclassified manufacturers], 16a pole board typ

jqx-115f-i51hs3 etc1 [list of unclassified manufacturers], 16a pole board typ

jqx-115f-i601hnil3 etc1 [list of unclassified manufacturers], 16a pole board typ

jqx-115f-i601hs3 etc1 [list of unclassified manufacturers], 16a pole board typ

jqx-115f-i61hnil3 etc1 [list of unclassified manufacturers], 16a pole board typ

jqx-115f-i61hs3 etc1 [list of unclassified manufacturers], 16a pole board typ

jqx-115f-t реле

jqx-115f-t-005-1z3-551 glenair

jqx-115f-t0051hnil3a реле

jqx-115f-t0051hnil3b реле

jqx-115f-t0051hnil3nil реле

jqx-115f-t0051hs3a реле

jqx-115f-t0051hs3b реле

jqx-115f-t0051hs3nil реле

jqx-115f-t0051znil3a реле

jqx-115f-t0051znil3b реле

jqx-115f-t0051znil3nil реле

jqx-115f-t0051zs3a реле

jqx-115f-t0051zs3b реле

jqx-115f-t0051zs3nil реле

jqx-115f-t0061hnil3a реле

jqx-115f-t0061hnil3b реле

jqx-115f-t0061hnil3nil реле

jqx-115f-t0061hs3a реле

jqx-115f-t0061hs3b реле

jqx-115f-t0061hs3nil реле

jqx-115f-t0061znil3a реле

jqx-115f-t0061znil3b реле

jqx-115f-t0061znil3nil реле

jqx-115f-t0061zs3a реле

jqx-115f-t0061zs3b реле

jqx-115f-t0061zs3nil реле

jqx-115f-t0091hnil3a реле

jqx-115f-t0091hnil3b реле
jqx-115f-t0091hnil3nil реле
jqx-115f-t0091hs3a реле
jqx-115f-t0091hs3b реле
jqx-115f-t0091hs3nil реле
jqx-115f-t0091znil3a реле
jqx-115f-t0091znil3b реле
jqx-115f-t0091znil3nil реле
jqx-115f-t0091zs3a реле
jqx-115f-t0091zs3b реле
jqx-115f-t0091zs3nil реле
jqx-115f-t0121hnil3a реле
jqx-115f-t0121hnil3b реле
jqx-115f-t0121hnil3nil реле
jqx-115f-t0121hs3a реле
jqx-115f-t0121hs3b реле
jqx-115f-t0121hs3nil реле
jqx-115f-t0121znil3a реле
jqx-115f-t0121znil3b реле
jqx-115f-t0121znil3nil реле
jqx-115f-t0121zs3a реле
jqx-115f-t0121zs3b реле
jqx-115f-t0121zs3nil реле
jqx-115f-t0181hnil3a реле
jqx-115f-t0181hnil3b реле
jqx-115f-t0181hnil3nil реле
jqx-115f-t0181hs3a реле
jqx-115f-t0181hs3b реле

jqx-115f-t0181hs3nil	реле
jqx-115f-t0181znil3a	реле
jqx-115f-t0181znil3b	реле
jqx-115f-t0181znil3nil	реле
jqx-115f-t0181zs3a	реле
jqx-115f-t0181zs3b	реле
jqx-115f-t0181zs3nil	реле
jqx-115f-t0241hnil3a	реле
jqx-115f-t0241hnil3b	реле
jqx-115f-t0241hnil3nil	реле
jqx-115f-t0241hs3a	реле
jqx-115f-t0241hs3b	реле
jqx-115f-t0241hs3nil	реле
jqx-115f-t0241znil3a	реле
jqx-115f-t0241znil3b	реле
jqx-115f-t0241znil3nil	реле
jqx-115f-t0241zs3a	реле
jqx-115f-t0241zs3b	реле
jqx-115f-t0241zs3nil	реле
jqx-115f-t0481hnil3a	реле
jqx-115f-t0481hnil3b	реле
jqx-115f-t0481hnil3nil	реле
jqx-115f-t0481hs3a	реле
jqx-115f-t0481hs3b	реле
jqx-115f-t0481hs3nil	реле
jqx-115f-t0481znil3a	реле
jqx-115f-t0481znil3b	реле
jqx-115f-t0481znil3nil	реле

jqx-115f-t0481zs3a реле
jqx-115f-t0481zs3b реле
jqx-115f-t0481zs3nil реле
jqx-115f-t0601hnil3a реле
jqx-115f-t0601hnil3b реле
jqx-115f-t0601hnil3nil реле
jqx-115f-t0601hs3a реле
jqx-115f-t0601hs3b реле
jqx-115f-t0601hs3nil реле
jqx-115f-t0601znil3a реле
jqx-115f-t0601znil3b реле
jqx-115f-t0601znil3nil реле
jqx-115f-t0601zs3a реле
jqx-115f-t0601zs3b реле
jqx-115f-t0601zs3nil реле
jqx-115f-th реле
jqx-115f-th0051hnil3a реле
jqx-115f-th0051hnil3b реле
jqx-115f-th0051hnil3nil реле
jqx-115f-th0051hs3a реле
jqx-115f-th0051hs3b реле
jqx-115f-th0051hs3nil реле
jqx-115f-th0051znil3a реле
jqx-115f-th0051znil3b реле
jqx-115f-th0051znil3nil реле
jqx-115f-th0051zs3a реле
jqx-115f-th0051zs3b реле
jqx-115f-th0051zs3nil реле

jqx-115f-th0061hnil3a реле
jqx-115f-th0061hnil3b реле
jqx-115f-th0061hnil3nil реле
jqx-115f-th0061hs3a реле
jqx-115f-th0061hs3b реле
jqx-115f-th0061hs3nil реле
jqx-115f-th0061znil3a реле
jqx-115f-th0061znil3b реле
jqx-115f-th0061znil3nil реле
jqx-115f-th0061zs3a реле
jqx-115f-th0061zs3b реле
jqx-115f-th0061zs3nil реле
jqx-115f-th0091hnil3a реле
jqx-115f-th0091hnil3b реле
jqx-115f-th0091hnil3nil реле
jqx-115f-th0091hs3a реле
jqx-115f-th0091hs3b реле
jqx-115f-th0091hs3nil реле
jqx-115f-th0091znil3a реле
jqx-115f-th0091znil3b реле
jqx-115f-th0091znil3nil реле
jqx-115f-th0091zs3a реле
jqx-115f-th0091zs3b реле
jqx-115f-th0091zs3nil реле
jqx-115f-th0121hnil3a реле
jqx-115f-th0121hnil3b реле
jqx-115f-th0121hnil3nil реле
jqx-115f-th0121hs3a реле

jqx-115f-th0121hs3b реле
jqx-115f-th0121hs3nil реле
jqx-115f-th0121znil3a реле
jqx-115f-th0121znil3b реле
jqx-115f-th0121znil3nil реле
jqx-115f-th0121zs3a реле
jqx-115f-th0121zs3b реле
jqx-115f-th0121zs3nil реле
jqx-115f-th0181hnil3a реле
jqx-115f-th0181hnil3b реле
jqx-115f-th0181hnil3nil реле
jqx-115f-th0181hs3a реле
jqx-115f-th0181hs3b реле
jqx-115f-th0181hs3nil реле
jqx-115f-th0181znil3a реле
jqx-115f-th0181znil3b реле
jqx-115f-th0181znil3nil реле
jqx-115f-th0181zs3a реле
jqx-115f-th0181zs3b реле
jqx-115f-th0181zs3nil реле
jqx-115f-th0241hnil3a реле
jqx-115f-th0241hnil3b реле
jqx-115f-th0241hnil3nil реле
jqx-115f-th0241hs3a реле
jqx-115f-th0241hs3b реле
jqx-115f-th0241hs3nil реле
jqx-115f-th0241znil3a реле
jqx-115f-th0241znil3b реле

jqx-115f-th0241znil3nil реле
jqx-115f-th0241zs3a реле
jqx-115f-th0241zs3b реле
jqx-115f-th0241zs3nil реле
jqx-115f-th0481hnil3a реле
jqx-115f-th0481hnil3b реле
jqx-115f-th0481hnil3nil реле
jqx-115f-th0481hs3a реле
jqx-115f-th0481hs3b реле
jqx-115f-th0481hs3nil реле
jqx-115f-th0481znil3a реле
jqx-115f-th0481znil3b реле
jqx-115f-th0481znil3nil реле
jqx-115f-th0481zs3a реле
jqx-115f-th0481zs3b реле
jqx-115f-th0481zs3nil реле
jqx-115f-th0601hnil3a реле
jqx-115f-th0601hnil3b реле
jqx-115f-th0601hnil3nil реле
jqx-115f-th0601hs3a реле
jqx-115f-th0601hs3b реле
jqx-115f-th0601hs3nil реле
jqx-115f-th0601znil3a реле
jqx-115f-th0601znil3b реле
jqx-115f-th0601znil3nil реле
jqx-115f-th0601zs3a реле
jqx-115f-th0601zs3b реле
jqx-115f-th0601zs3nil реле

jqx-115f/012-1zs3 (551) hongfa electroacoustic co.,ltd., реле средней мощности; $i_{к,а} = 16$; $u_{к,в} = 250\text{vac}$; $i_{н,в} = 12$; $p_{в,т} = 0.4$; кол. ком. гр. = 1; вид конт. группы с; $u_{i/o,в} = 1000$; тэкср, °с -40...+85; тип упр. и дс; вр. сраб. <15ms; тип монт. pcb; 29x12,

jqx-115f/0121ds1 реле

jqx-115f/0121ds2.3 реле

jqx-115f/0121ds4 реле

jqx-115f/0121hs1 реле

jqx-115f/0121hs2.3 реле

jqx-115f/0121hs4 реле

jqx-115f/0121zs1 реле

jqx-115f/0121zs2.3 реле

jqx-115f/0121zs4 реле

jqx-115f/0122ds1 реле

jqx-115f/0122ds2.3 реле

jqx-115f/0122ds4 реле

jqx-115f/0122hs1 реле

jqx-115f/0122hs2.3 реле

jqx-115f/0122hs4 реле

jqx-115f/0122zs1 реле

jqx-115f/0122zs2.3 реле

jqx-115f/0122zs4 реле

jqx-115f/1101ds1 реле

jqx-115f/1101ds2.3 реле

jqx-115f/1101ds4 реле

jqx-115f/1101hs1 реле

jqx-115f/1101hs2.3 реле

jqx-115f/1101hs4 реле

jqx-115f/1101zs1 реле

jqx-115f/1101zs2.3 реле

jqx-115f/1101zs4	реле
jqx-115f/1102ds1	реле
jqx-115f/1102ds2.3	реле
jqx-115f/1102ds4	реле
jqx-115f/1102hs1	реле
jqx-115f/1102hs2.3	реле
jqx-115f/1102hs4	реле
jqx-115f/1102zs1	реле
jqx-115f/1102zs2.3	реле
jqx-115f/1102zs4	реле
jqx-115f/121ds1	реле
jqx-115f/121ds2.3	реле
jqx-115f/121ds4	реле
jqx-115f/121hs1	реле
jqx-115f/121hs2.3	реле
jqx-115f/121hs4	реле
jqx-115f/121zs1	реле
jqx-115f/121zs2.3	реле
jqx-115f/121zs4	реле
jqx-115f/122ds1	реле
jqx-115f/122ds2.3	реле
jqx-115f/122ds4	реле
jqx-115f/122hs1	реле
jqx-115f/122hs2.3	реле
jqx-115f/122hs4	реле
jqx-115f/122zs1	реле
jqx-115f/122zs2.3	реле
jqx-115f/122zs4	реле

jqx-115f/241ds1	реле
jqx-115f/241ds2.3	реле
jqx-115f/241ds4	реле
jqx-115f/241hs1	реле
jqx-115f/241hs2.3	реле
jqx-115f/241hs4	реле
jqx-115f/241zs1	реле
jqx-115f/241zs2.3	реле
jqx-115f/241zs4	реле
jqx-115f/242ds1	реле
jqx-115f/242ds2.3	реле
jqx-115f/242ds4	реле
jqx-115f/242hs1	реле
jqx-115f/242hs2.3	реле
jqx-115f/242hs4	реле
jqx-115f/242zs1	реле
jqx-115f/242zs2.3	реле
jqx-115f/242zs4	реле
jqx-115f/481ds1	реле
jqx-115f/481ds2.3	реле
jqx-115f/481ds4	реле
jqx-115f/481hs1	реле
jqx-115f/481hs2.3	реле
jqx-115f/481hs4	реле
jqx-115f/481zs1	реле
jqx-115f/481zs2.3	реле
jqx-115f/481zs4	реле
jqx-115f/482ds1	реле

jqx-115f/482ds2.3	реле
jqx-115f/482ds4	реле
jqx-115f/482hs1	реле
jqx-115f/482hs2.3	реле
jqx-115f/482hs4	реле
jqx-115f/482zs1	реле
jqx-115f/482zs2.3	реле
jqx-115f/482zs4	реле
jqx-115f/51ds1	реле
jqx-115f/51ds2.3	реле
jqx-115f/51ds4	реле
jqx-115f/51hs1	реле
jqx-115f/51hs2.3	реле
jqx-115f/51hs4	реле
jqx-115f/51zs1	реле
jqx-115f/51zs2.3	реле
jqx-115f/51zs4	реле
jqx-115f/52ds1	реле
jqx-115f/52ds2.3	реле
jqx-115f/52ds4	реле
jqx-115f/52hs1	реле
jqx-115f/52hs2.3	реле
jqx-115f/52hs4	реле
jqx-115f/52zs1	реле
jqx-115f/52zs2.3	реле
jqx-115f/52zs4	реле
jqx-115f/601ds1	реле
jqx-115f/601ds2.3	реле

jqx-115f/601ds4	реле
jqx-115f/601hs1	реле
jqx-115f/601hs2.3	реле
jqx-115f/601hs4	реле
jqx-115f/601zs1	реле
jqx-115f/601zs2.3	реле
jqx-115f/601zs4	реле
jqx-115f/602ds1	реле
jqx-115f/602ds2.3	реле
jqx-115f/602ds4	реле
jqx-115f/602hs1	реле
jqx-115f/602hs2.3	реле
jqx-115f/602hs4	реле
jqx-115f/602zs1	реле
jqx-115f/602zs2.3	реле
jqx-115f/602zs4	реле
jqx-115f/61ds1	реле
jqx-115f/61ds2.3	реле
jqx-115f/61ds4	реле
jqx-115f/61hs1	реле
jqx-115f/61hs2.3	реле
jqx-115f/61hs4	реле
jqx-115f/61zs1	реле
jqx-115f/61zs2.3	реле
jqx-115f/61zs4	реле
jqx-115f/62ds1	реле
jqx-115f/62ds2.3	реле
jqx-115f/62ds4	реле

jqx-115f/62hs1 реле
jqx-115f/62hs2.3 реле
jqx-115f/62hs4 реле
jqx-115f/62zs1 реле
jqx-115f/62zs2.3 реле
jqx-115f/62zs4 реле
jqx-115f012-1zs2
jqx-116f-1 реле
jqx-116f-1/асаа1h реле
jqx-116f-1/асаа2h реле
jqx-116f-1/асаf1h реле
jqx-116f-1/асаf2h реле
jqx-116f-1/асаp1h реле
jqx-116f-1/асаp2h реле
jqx-116f-1/асda1h реле
jqx-116f-1/асda2h реле
jqx-116f-1/асdf1h реле
jqx-116f-1/асdf2h реле
jqx-116f-1/асdp1h реле
jqx-116f-1/асdp2h реле
jqx-116f-1/dcaа1h реле
jqx-116f-1/dcaа2h реле
jqx-116f-1/dcaf1h реле
jqx-116f-1/dcaf2h реле
jqx-116f-1/dсаp1h реле
jqx-116f-1/dсаp2h реле
jqx-116f-1/dcda1h реле
jqx-116f-1/dcda2h реле

jqx-116f-1/dcdf1h	реле
jqx-116f-1/dcdf2h	реле
jqx-116f-1/dcdp1h	реле
jqx-116f-1/dcdp2h	реле
jqx-116f-2	реле
jqx-116f-2/018a1hniltfw	реле
jqx-116f-2/018a1hsnilfw	реле
jqx-116f-2/018a1hstfw	реле
jqx-116f-2/018a2hniltfw	реле
jqx-116f-2/018a2hsnilfw	реле
jqx-116f-2/018a2hstfw	реле
jqx-116f-2/018ap1hniltfw	реле
jqx-116f-2/018ap1hsnilfw	реле
jqx-116f-2/018ap1hstfw	реле
jqx-116f-2/018ap2hniltfw	реле
jqx-116f-2/018ap2hsnilfw	реле
jqx-116f-2/018ap2hstfw	реле
jqx-116f-2/018dl1hniltfw	реле
jqx-116f-2/018dl1hsnilfw	реле
jqx-116f-2/018dl1hstfw	реле
jqx-116f-2/018dl2hniltfw	реле
jqx-116f-2/018dl2hsnilfw	реле
jqx-116f-2/018dl2hstfw	реле
jqx-116f-2/018dp1hniltfw	реле
jqx-116f-2/018dp1hsnilfw	реле
jqx-116f-2/018dp1hstfw	реле
jqx-116f-2/018dp2hniltfw	реле

jqx-116f-2/018dp2hsnilfw	реле
jqx-116f-2/018dp2hstfw	реле
jqx-116f-3	реле
jqx-116f-3/003aa1hnilfw	реле
jqx-116f-3/003aa1hnilnilw	реле
jqx-116f-3/003aa1htfw	реле
jqx-116f-3/003aa1htnilw	реле
jqx-116f-3/003aa2hnilfw	реле
jqx-116f-3/003aa2hnilnilw	реле
jqx-116f-3/003aa2htfw	реле
jqx-116f-3/003aa2htnilw	реле
jqx-116f-3/003af1hnilfw	реле
jqx-116f-3/003af1hnilnilw	реле
jqx-116f-3/003af1htfw	реле
jqx-116f-3/003af1htnilw	реле
jqx-116f-3/003af2hnilfw	реле
jqx-116f-3/003af2hnilnilw	реле
jqx-116f-3/003af2htfw	реле
jqx-116f-3/003af2htnilw	реле
jqx-116f-3/003da1hnilfw	реле
jqx-116f-3/003da1hnilnilw	реле
jqx-116f-3/003da1htfw	реле
jqx-116f-3/003da1htnilw	реле
jqx-116f-3/003da2hnilfw	реле
jqx-116f-3/003da2hnilnilw	реле
jqx-116f-3/003da2htfw	реле
jqx-116f-3/003da2htnilw	реле
jqx-116f-3/003df1hnilfw	реле

jqx-116f-3/003df1hnilnilw	реле
jqx-116f-3/003df1htfw	реле
jqx-116f-3/003df1htnilw	реле
jqx-116f-3/003df2hnilfw	реле
jqx-116f-3/003df2hnilnilw	реле
jqx-116f-3/003df2htfw	реле
jqx-116f-3/003df2htnilw	реле
jqx-116f-3/006aa1hnilfw	реле
jqx-116f-3/006aa1hnilnilw	реле
jqx-116f-3/006aa1htfw	реле
jqx-116f-3/006aa1htnilw	реле
jqx-116f-3/006aa2hnilfw	реле
jqx-116f-3/006aa2hnilnilw	реле
jqx-116f-3/006aa2htfw	реле
jqx-116f-3/006aa2htnilw	реле
jqx-116f-3/006af1hnilfw	реле
jqx-116f-3/006af1hnilnilw	реле
jqx-116f-3/006af1htfw	реле
jqx-116f-3/006af1htnilw	реле
jqx-116f-3/006af2hnilfw	реле
jqx-116f-3/006af2hnilnilw	реле
jqx-116f-3/006af2htfw	реле
jqx-116f-3/006af2htnilw	реле
jqx-116f-3/006da1hnilfw	реле
jqx-116f-3/006da1hnilnilw	реле
jqx-116f-3/006da1htfw	реле
jqx-116f-3/006da1htnilw	реле
jqx-116f-3/006da2hnilfw	реле

jqx-116f-3/006da2hnilnilw	реле
jqx-116f-3/006da2htfw	реле
jqx-116f-3/006da2htnilw	реле
jqx-116f-3/006df1hnilfw	реле
jqx-116f-3/006df1hnilnilw	реле
jqx-116f-3/006df1htfw	реле
jqx-116f-3/006df1htnilw	реле
jqx-116f-3/006df2hnilfw	реле
jqx-116f-3/006df2hnilnilw	реле
jqx-116f-3/006df2htfw	реле
jqx-116f-3/006df2htnilw	реле
jqx-116f-3/018aa1hnilfw	реле
jqx-116f-3/018aa1hnilnilw	реле
jqx-116f-3/018aa1htfw	реле
jqx-116f-3/018aa1htnilw	реле
jqx-116f-3/018aa2hnilfw	реле
jqx-116f-3/018aa2hnilnilw	реле
jqx-116f-3/018aa2htfw	реле
jqx-116f-3/018aa2htnilw	реле
jqx-116f-3/018af1hnilfw	реле
jqx-116f-3/018af1hnilnilw	реле
jqx-116f-3/018af1htfw	реле
jqx-116f-3/018af1htnilw	реле
jqx-116f-3/018af2hnilfw	реле
jqx-116f-3/018af2hnilnilw	реле
jqx-116f-3/018af2htfw	реле
jqx-116f-3/018af2htnilw	реле
jqx-116f-3/018da1hnilfw	реле

jqx-116f-3/018da1hnilnilw	реле
jqx-116f-3/018da1htfw	реле
jqx-116f-3/018da1htnilw	реле
jqx-116f-3/018da2hnilfw	реле
jqx-116f-3/018da2hnilnilw	реле
jqx-116f-3/018da2htfw	реле
jqx-116f-3/018da2htnilw	реле
jqx-116f-3/018df1hnilfw	реле
jqx-116f-3/018df1hnilnilw	реле
jqx-116f-3/018df1htfw	реле
jqx-116f-3/018df1htnilw	реле
jqx-116f-3/018df2hnilfw	реле
jqx-116f-3/018df2hnilnilw	реле
jqx-116f-3/018df2htfw	реле
jqx-116f-3/018df2htnilw	реле
jqx-116f-3/200aa1hnilfw	реле
jqx-116f-3/200aa1hnilnilw	реле
jqx-116f-3/200aa1htfw	реле
jqx-116f-3/200aa1htnilw	реле
jqx-116f-3/200aa2hnilfw	реле
jqx-116f-3/200aa2hnilnilw	реле
jqx-116f-3/200aa2htfw	реле
jqx-116f-3/200aa2htnilw	реле
jqx-116f-3/200af1hnilfw	реле
jqx-116f-3/200af1hnilnilw	реле
jqx-116f-3/200af1htfw	реле
jqx-116f-3/200af1htnilw	реле
jqx-116f-3/200af2hnilfw	реле

jqx-116f-3/200af2hnilnilw	реле
jqx-116f-3/200af2htfw	реле
jqx-116f-3/200af2htnilw	реле
jqx-116f-3/200da1hnilfw	реле
jqx-116f-3/200da1hnilnilw	реле
jqx-116f-3/200da1htfw	реле
jqx-116f-3/200da1htnilw	реле
jqx-116f-3/200da2hnilfw	реле
jqx-116f-3/200da2hnilnilw	реле
jqx-116f-3/200da2htfw	реле
jqx-116f-3/200da2htnilw	реле
jqx-116f-3/200df1hnilfw	реле
jqx-116f-3/200df1hnilnilw	реле
jqx-116f-3/200df1htfw	реле
jqx-116f-3/200df1htnilw	реле
jqx-116f-3/200df2hnilfw	реле
jqx-116f-3/200df2hnilnilw	реле
jqx-116f-3/200df2htfw	реле
jqx-116f-3/200df2htnilw	реле
jqx-116f-3/240aa1hnilfw	реле
jqx-116f-3/240aa1hnilnilw	реле
jqx-116f-3/240aa1htfw	реле
jqx-116f-3/240aa1htnilw	реле
jqx-116f-3/240aa2hnilfw	реле
jqx-116f-3/240aa2hnilnilw	реле
jqx-116f-3/240aa2htfw	реле
jqx-116f-3/240aa2htnilw	реле
jqx-116f-3/240af1hnilfw	реле

jqx-116f-3/240af1hnilnilw реле
jqx-116f-3/240af1htfw реле
jqx-116f-3/240af1htnilw реле
jqx-116f-3/240af2hnilfw реле
jqx-116f-3/240af2hnilnilw реле
jqx-116f-3/240af2htfw реле
jqx-116f-3/240af2htnilw реле
jqx-116f-3/240da1hnilfw реле
jqx-116f-3/240da1hnilnilw реле
jqx-116f-3/240da1htfw реле
jqx-116f-3/240da1htnilw реле
jqx-116f-3/240da2hnilfw реле
jqx-116f-3/240da2hnilnilw реле
jqx-116f-3/240da2htfw реле
jqx-116f-3/240da2htnilw реле
jqx-116f-3/240df1hnilfw реле
jqx-116f-3/240df1hnilnilw реле
jqx-116f-3/240df1htfw реле
jqx-116f-3/240df1htnilw реле
jqx-116f-3/240df2hnilfw реле
jqx-116f-3/240df2hnilnilw реле
jqx-116f-3/240df2htfw реле
jqx-116f-3/240df2htnilw реле
jqx-118f-024-1zs1t-555 glenair
jqx-13f etc2 [list of unclassified manufacturers], miniature intermediate power rela
jqx-13f-24vac
jqx-13f-24vdc
jqx-13f/1202z1 etc2 [list of unclassified manufacturers], miniature intermediate power rela

jqx-13f/1202z1d etc2 [list of unclassified manufacturers], miniature intermediate power rela
jqx-13f/1202z2 etc2 [list of unclassified manufacturers], miniature intermediate power rela
jqx-13f/1202z2d etc2 [list of unclassified manufacturers], miniature intermediate power rela
jqx-13f/1202z3 etc2 [list of unclassified manufacturers], miniature intermediate power rela
jqx-13f/1202z3d etc2 [list of unclassified manufacturers], miniature intermediate power rela
jqx-13f/1202z4 etc2 [list of unclassified manufacturers], miniature intermediate power rela
jqx-13f/1202z4d etc2 [list of unclassified manufacturers], miniature intermediate power rela
jqx-13f/1202z5 etc2 [list of unclassified manufacturers], miniature intermediate power rela
jqx-13f/1202z5d etc2 [list of unclassified manufacturers], miniature intermediate power rela
jqx-13f/2201z1 etc2 [list of unclassified manufacturers], miniature intermediate power rela
jqx-13f/2201z1d etc2 [list of unclassified manufacturers], miniature intermediate power rela
jqx-13f/2201z2 etc2 [list of unclassified manufacturers], miniature intermediate power rela
jqx-13f/2201z2d etc2 [list of unclassified manufacturers], miniature intermediate power rela
jqx-13f/2201z3 etc2 [list of unclassified manufacturers], miniature intermediate power rela
jqx-13f/2201z3d etc2 [list of unclassified manufacturers], miniature intermediate power rela
jqx-13f/2201z4 etc2 [list of unclassified manufacturers], miniature intermediate power rela
jqx-13f/2201z4d etc2 [list of unclassified manufacturers], miniature intermediate power rela
jqx-13f/2201z5 etc2 [list of unclassified manufacturers], miniature intermediate power rela
jqx-13f/2201z5d etc2 [list of unclassified manufacturers], miniature intermediate power rela
jqx-13f/2202z1 etc2 [list of unclassified manufacturers], miniature intermediate power rela
jqx-13f/2202z1d etc2 [list of unclassified manufacturers], miniature intermediate power rela
jqx-13f/2202z2 etc2 [list of unclassified manufacturers], miniature intermediate power rela
jqx-13f/2202z2d etc2 [list of unclassified manufacturers], miniature intermediate power rela
jqx-13f/2202z3 etc2 [list of unclassified manufacturers], miniature intermediate power rela
jqx-13f/2202z3d etc2 [list of unclassified manufacturers], miniature intermediate power rela
jqx-13f/2202z4 etc2 [list of unclassified manufacturers], miniature intermediate power rela
jqx-13f/2202z4d etc2 [list of unclassified manufacturers], miniature intermediate power rela
jqx-13f/2202z5 etc2 [list of unclassified manufacturers], miniature intermediate power rela

jqx-13f/2202z5d etc2 [list of unclassified manufacturers], miniature intermediate power rela

jqx-13f/2402z1 etc2 [list of unclassified manufacturers], miniature intermediate power rela

jqx-13f/2402z1d etc2 [list of unclassified manufacturers], miniature intermediate power rela

jqx-13f/2402z2 etc2 [list of unclassified manufacturers], miniature intermediate power rela

jqx-13f/2402z2d etc2 [list of unclassified manufacturers], miniature intermediate power rela

jqx-13f/2402z3 etc2 [list of unclassified manufacturers], miniature intermediate power rela

jqx-13f/2402z3d etc2 [list of unclassified manufacturers], miniature intermediate power rela

jqx-13f/2402z4 etc2 [list of unclassified manufacturers], miniature intermediate power rela

jqx-13f/2402z4d etc2 [list of unclassified manufacturers], miniature intermediate power rela

jqx-13f/2402z5 etc2 [list of unclassified manufacturers], miniature intermediate power rela

jqx-13f/2402z5d etc2 [list of unclassified manufacturers], miniature intermediate power rela

jqx-13f/a0122z1d016 etc2 [list of unclassified manufacturers], miniature intermediate power rela

jqx-13f/a0281z1 etc2 [list of unclassified manufacturers], miniature intermediate power rela

jqx-13f/a0281z1d etc2 [list of unclassified manufacturers], miniature intermediate power rela

jqx-13f/a0281z2 etc2 [list of unclassified manufacturers], miniature intermediate power rela

jqx-13f/a0281z2d etc2 [list of unclassified manufacturers], miniature intermediate power rela

jqx-13f/a0281z3 etc2 [list of unclassified manufacturers], miniature intermediate power rela

jqx-13f/a0281z3d etc2 [list of unclassified manufacturers], miniature intermediate power rela

jqx-13f/a0281z4 etc2 [list of unclassified manufacturers], miniature intermediate power rela

jqx-13f/a0281z4d etc2 [list of unclassified manufacturers], miniature intermediate power rela

jqx-13f/a0281z5 etc2 [list of unclassified manufacturers], miniature intermediate power rela

jqx-13f/a0281z5d etc2 [list of unclassified manufacturers], miniature intermediate power rela

jqx-13f/a0282z1 etc2 [list of unclassified manufacturers], miniature intermediate power rela

jqx-13f/a0282z1d etc2 [list of unclassified manufacturers], miniature intermediate power rela

jqx-13f/a0282z2 etc2 [list of unclassified manufacturers], miniature intermediate power rela

jqx-13f/a0282z2d etc2 [list of unclassified manufacturers], miniature intermediate power rela

jqx-13f/a0282z3 etc2 [list of unclassified manufacturers], miniature intermediate power rela

jqx-13f/a0282z3d etc2 [list of unclassified manufacturers], miniature intermediate power rela

jqx-13f/a0282z4	etc2 [list of unclassified manufacturers], miniature intermediate power rela
jqx-13f/a0282z4d	etc2 [list of unclassified manufacturers], miniature intermediate power rela
jqx-13f/a0282z5	etc2 [list of unclassified manufacturers], miniature intermediate power rela
jqx-13f/a0282z5d	etc2 [list of unclassified manufacturers], miniature intermediate power rela
jqx-13f/a0301z1	etc2 [list of unclassified manufacturers], miniature intermediate power rela
jqx-13f/a0301z1d	etc2 [list of unclassified manufacturers], miniature intermediate power rela
jqx-13f/a0301z2	etc2 [list of unclassified manufacturers], miniature intermediate power rela
jqx-13f/a0301z2d	etc2 [list of unclassified manufacturers], miniature intermediate power rela
jqx-13f/a0301z3	etc2 [list of unclassified manufacturers], miniature intermediate power rela
jqx-13f/a0301z3d	etc2 [list of unclassified manufacturers], miniature intermediate power rela
jqx-13f/a0301z4	etc2 [list of unclassified manufacturers], miniature intermediate power rela
jqx-13f/a0301z4d	etc2 [list of unclassified manufacturers], miniature intermediate power rela
jqx-13f/a0301z5	etc2 [list of unclassified manufacturers], miniature intermediate power rela
jqx-13f/a0301z5d	etc2 [list of unclassified manufacturers], miniature intermediate power rela
jqx-13f/a0302z1	etc2 [list of unclassified manufacturers], miniature intermediate power rela
jqx-13f/a0302z1d	etc2 [list of unclassified manufacturers], miniature intermediate power rela
jqx-13f/a0302z2	etc2 [list of unclassified manufacturers], miniature intermediate power rela
jqx-13f/a0302z2d	etc2 [list of unclassified manufacturers], miniature intermediate power rela
jqx-13f/a0302z3	etc2 [list of unclassified manufacturers], miniature intermediate power rela
jqx-13f/a0302z3d	etc2 [list of unclassified manufacturers], miniature intermediate power rela
jqx-13f/a0302z4	etc2 [list of unclassified manufacturers], miniature intermediate power rela
jqx-13f/a0302z4d	etc2 [list of unclassified manufacturers], miniature intermediate power rela
jqx-13f/a0302z5	etc2 [list of unclassified manufacturers], miniature intermediate power rela
jqx-13f/a0302z5d	etc2 [list of unclassified manufacturers], miniature intermediate power rela
jqx-13f1aaac110v1d	реле
jqx-13f1aaac110v1l	реле
jqx-13f1aaac110v1ld	реле
jqx-13f1aaac110v1nil	реле

jqx-13f1aaac110v2d	реле
jqx-13f1aaac110v2l	реле
jqx-13f1aaac110v2ld	реле
jqx-13f1aaac110v2nil	реле
jqx-13f1aaac12v1d	реле
jqx-13f1aaac12v1l	реле
jqx-13f1aaac12v1ld	реле
jqx-13f1aaac12v1nil	реле
jqx-13f1aaac12v2d	реле
jqx-13f1aaac12v2l	реле
jqx-13f1aaac12v2ld	реле
jqx-13f1aaac12v2nil	реле
jqx-13f1aaac24v1d	реле
jqx-13f1aaac24v1l	реле
jqx-13f1aaac24v1ld	реле
jqx-13f1aaac24v1nil	реле
jqx-13f1aaac24v2d	реле
jqx-13f1aaac24v2l	реле
jqx-13f1aaac24v2ld	реле
jqx-13f1aaac24v2nil	реле
jqx-13f1aaac36v1d	реле
jqx-13f1aaac36v1l	реле
jqx-13f1aaac36v1ld	реле
jqx-13f1aaac36v1nil	реле
jqx-13f1aaac36v2d	реле
jqx-13f1aaac36v2l	реле
jqx-13f1aaac36v2ld	реле
jqx-13f1aaac36v2nil	реле

jqx-13f1aac48v1d	реле
jqx-13f1aac48v1l	реле
jqx-13f1aac48v1ld	реле
jqx-13f1aac48v1nil	реле
jqx-13f1aac48v2d	реле
jqx-13f1aac48v2l	реле
jqx-13f1aac48v2ld	реле
jqx-13f1aac48v2nil	реле
jqx-13f1aad110v1	ningbo forward relay corporation
jqx-13f1aad110v1d	реле
jqx-13f1aad110v1l	реле
jqx-13f1aad110v1ld	реле
jqx-13f1aad110v1nil	реле
jqx-13f1aad110v2d	реле
jqx-13f1aad110v2l	реле
jqx-13f1aad110v2ld	реле
jqx-13f1aad110v2nil	реле
jqx-13f1aad12v1d	реле
jqx-13f1aad12v1l	реле
jqx-13f1aad12v1ld	реле
jqx-13f1aad12v1nil	реле
jqx-13f1aad12v2d	реле
jqx-13f1aad12v2l	реле
jqx-13f1aad12v2ld	реле
jqx-13f1aad12v2nil	реле
jqx-13f1aad24v1d	реле
jqx-13f1aad24v1l	реле
jqx-13f1aad24v1ld	реле

jqx-13f1aadc24v1nil	реле
jqx-13f1aadc24v2d	реле
jqx-13f1aadc24v2l	реле
jqx-13f1aadc24v2ld	реле
jqx-13f1aadc24v2nil	реле
jqx-13f1aadc36v1d	реле
jqx-13f1aadc36v1l	реле
jqx-13f1aadc36v1ld	реле
jqx-13f1aadc36v1nil	реле
jqx-13f1aadc36v2d	реле
jqx-13f1aadc36v2l	реле
jqx-13f1aadc36v2ld	реле
jqx-13f1aadc36v2nil	реле
jqx-13f1aadc48v1d	реле
jqx-13f1aadc48v1l	реле
jqx-13f1aadc48v1ld	реле
jqx-13f1aadc48v1nil	реле
jqx-13f1aadc48v2d	реле
jqx-13f1aadc48v2l	реле
jqx-13f1aadc48v2ld	реле
jqx-13f1aadc48v2nil	реле
jqx-13f1abac110v1d	реле
jqx-13f1abac110v1l	реле
jqx-13f1abac110v1ld	реле
jqx-13f1abac110v1nil	реле
jqx-13f1abac110v2d	реле
jqx-13f1abac110v2l	реле
jqx-13f1abac110v2ld	реле

jqx-13f1abac110v2nil	реле
jqx-13f1abac12v1d	реле
jqx-13f1abac12v1l	реле
jqx-13f1abac12v1ld	реле
jqx-13f1abac12v1nil	реле
jqx-13f1abac12v2d	реле
jqx-13f1abac12v2l	реле
jqx-13f1abac12v2ld	реле
jqx-13f1abac12v2nil	реле
jqx-13f1abac24v1d	реле
jqx-13f1abac24v1l	реле
jqx-13f1abac24v1ld	реле
jqx-13f1abac24v1nil	реле
jqx-13f1abac24v2d	реле
jqx-13f1abac24v2l	реле
jqx-13f1abac24v2ld	реле
jqx-13f1abac24v2nil	реле
jqx-13f1abac36v1d	реле
jqx-13f1abac36v1l	реле
jqx-13f1abac36v1ld	реле
jqx-13f1abac36v1nil	реле
jqx-13f1abac36v2d	реле
jqx-13f1abac36v2l	реле
jqx-13f1abac36v2ld	реле
jqx-13f1abac36v2nil	реле
jqx-13f1abac48v1d	реле
jqx-13f1abac48v1l	реле
jqx-13f1abac48v1ld	реле

jqx-13f1abac48v1nil	реле
jqx-13f1abac48v2d	реле
jqx-13f1abac48v2l	реле
jqx-13f1abac48v2ld	реле
jqx-13f1abac48v2nil	реле
jqx-13f1abdc110v1d	реле
jqx-13f1abdc110v1l	реле
jqx-13f1abdc110v1ld	реле
jqx-13f1abdc110v1nil	реле
jqx-13f1abdc110v2d	реле
jqx-13f1abdc110v2l	реле
jqx-13f1abdc110v2ld	реле
jqx-13f1abdc110v2nil	реле
jqx-13f1abdc12v1d	реле
jqx-13f1abdc12v1l	реле
jqx-13f1abdc12v1ld	реле
jqx-13f1abdc12v1nil	реле
jqx-13f1abdc12v2d	реле
jqx-13f1abdc12v2l	реле
jqx-13f1abdc12v2ld	реле
jqx-13f1abdc12v2nil	реле
jqx-13f1abdc24v1d	реле
jqx-13f1abdc24v1l	реле
jqx-13f1abdc24v1ld	реле
jqx-13f1abdc24v1nil	реле
jqx-13f1abdc24v2d	реле
jqx-13f1abdc24v2l	реле
jqx-13f1abdc24v2ld	реле

jqx-13f1abdc24v2nil	реле
jqx-13f1abdc36v1d	реле
jqx-13f1abdc36v1l	реле
jqx-13f1abdc36v1ld	реле
jqx-13f1abdc36v1nil	реле
jqx-13f1abdc36v2d	реле
jqx-13f1abdc36v2l	реле
jqx-13f1abdc36v2ld	реле
jqx-13f1abdc36v2nil	реле
jqx-13f1abdc48v1d	реле
jqx-13f1abdc48v1l	реле
jqx-13f1abdc48v1ld	реле
jqx-13f1abdc48v1nil	реле
jqx-13f1abdc48v2d	реле
jqx-13f1abdc48v2l	реле
jqx-13f1abdc48v2ld	реле
jqx-13f1abdc48v2nil	реле
jqx-13f1baac110v1d	реле
jqx-13f1baac110v1l	реле
jqx-13f1baac110v1ld	реле
jqx-13f1baac110v1nil	реле
jqx-13f1baac110v2d	реле
jqx-13f1baac110v2l	реле
jqx-13f1baac110v2ld	реле
jqx-13f1baac110v2nil	реле
jqx-13f1baac12v1d	реле
jqx-13f1baac12v1l	реле
jqx-13f1baac12v1ld	реле

jqx-13f1baac12v1nil	реле
jqx-13f1baac12v2d	реле
jqx-13f1baac12v2l	реле
jqx-13f1baac12v2ld	реле
jqx-13f1baac12v2nil	реле
jqx-13f1baac24v1d	реле
jqx-13f1baac24v1l	реле
jqx-13f1baac24v1ld	реле
jqx-13f1baac24v1nil	реле
jqx-13f1baac24v2d	реле
jqx-13f1baac24v2l	реле
jqx-13f1baac24v2ld	реле
jqx-13f1baac24v2nil	реле
jqx-13f1baac36v1d	реле
jqx-13f1baac36v1l	реле
jqx-13f1baac36v1ld	реле
jqx-13f1baac36v1nil	реле
jqx-13f1baac36v2d	реле
jqx-13f1baac36v2l	реле
jqx-13f1baac36v2ld	реле
jqx-13f1baac36v2nil	реле
jqx-13f1baac48v1d	реле
jqx-13f1baac48v1l	реле
jqx-13f1baac48v1ld	реле
jqx-13f1baac48v1nil	реле
jqx-13f1baac48v2d	реле
jqx-13f1baac48v2l	реле
jqx-13f1baac48v2ld	реле

jqx-13f1baac48v2nil	реле
jqx-13f1badc110v1d	реле
jqx-13f1badc110v1l	реле
jqx-13f1badc110v1d	реле
jqx-13f1badc110v1nil	реле
jqx-13f1badc110v2d	реле
jqx-13f1badc110v2l	реле
jqx-13f1badc110v2ld	реле
jqx-13f1badc110v2nil	реле
jqx-13f1badc12v1d	реле
jqx-13f1badc12v1l	реле
jqx-13f1badc12v1ld	реле
jqx-13f1badc12v1nil	реле
jqx-13f1badc12v2d	реле
jqx-13f1badc12v2l	реле
jqx-13f1badc12v2ld	реле
jqx-13f1badc12v2nil	реле
jqx-13f1badc24v1d	реле
jqx-13f1badc24v1l	реле
jqx-13f1badc24v1ld	реле
jqx-13f1badc24v1nil	реле
jqx-13f1badc24v2d	реле
jqx-13f1badc24v2l	реле
jqx-13f1badc24v2ld	реле
jqx-13f1badc24v2nil	реле
jqx-13f1badc36v1d	реле
jqx-13f1badc36v1l	
jqx-13f1badc36v1ld	

jqx-13f1badc36v1nil	
jqx-13f1badc36v2d	реле
jqx-13f1badc36v2l	реле
jqx-13f1badc36v2ld	реле
jqx-13f1badc36v2nil	реле
jqx-13f1badc48v1d	реле
jqx-13f1badc48v1l	реле
jqx-13f1badc48v1ld	реле
jqx-13f1badc48v1nil	реле
jqx-13f1badc48v2d	реле
jqx-13f1badc48v2l	реле
jqx-13f1badc48v2ld	реле
jqx-13f1badc48v2nil	реле
jqx-13f1bbac110v1d	реле
jqx-13f1bbac110v1l	реле
jqx-13f1bbac110v1ld	реле
jqx-13f1bbac110v1nil	реле
jqx-13f1bbac110v2d	реле
jqx-13f1bbac110v2l	реле
jqx-13f1bbac110v2ld	реле
jqx-13f1bbac110v2nil	реле
jqx-13f1bbac12v1d	реле
jqx-13f1bbac12v1l	реле
jqx-13f1bbac12v1ld	реле
jqx-13f1bbac12v1nil	реле
jqx-13f1bbac12v2d	реле
jqx-13f1bbac12v2l	реле
jqx-13f1bbac12v2ld	реле

jqx-13f1bbac12v2nil	реле
jqx-13f1bbac24v1d	реле
jqx-13f1bbac24v1l	реле
jqx-13f1bbac24v1ld	реле
jqx-13f1bbac24v1nil	реле
jqx-13f1bbac24v2d	реле
jqx-13f1bbac24v2l	реле
jqx-13f1bbac24v2ld	реле
jqx-13f1bbac24v2nil	реле
jqx-13f1bbac36v1d	реле
jqx-13f1bbac36v1l	реле
jqx-13f1bbac36v1ld	реле
jqx-13f1bbac36v1nil	реле
jqx-13f1bbac36v2d	реле
jqx-13f1bbac36v2l	реле
jqx-13f1bbac36v2ld	реле
jqx-13f1bbac36v2nil	реле
jqx-13f1bbac48v1d	реле
jqx-13f1bbac48v1l	реле
jqx-13f1bbac48v1ld	реле
jqx-13f1bbac48v1nil	реле
jqx-13f1bbac48v2d	реле
jqx-13f1bbac48v2l	реле
jqx-13f1bbac48v2ld	реле
jqx-13f1bbac48v2nil	реле
jqx-13f1bbdc110v1d	реле
jqx-13f1bbdc110v1l	реле
jqx-13f1bbdc110v1ld	реле

jqx-13f1bbdc110v1nil	реле
jqx-13f1bbdc110v2d	реле
jqx-13f1bbdc110v2l	реле
jqx-13f1bbdc110v2ld	реле
jqx-13f1bbdc110v2nil	реле
jqx-13f1bbdc12v1d	реле
jqx-13f1bbdc12v1l	реле
jqx-13f1bbdc12v1ld	реле
jqx-13f1bbdc12v1nil	реле
jqx-13f1bbdc12v2d	реле
jqx-13f1bbdc12v2l	реле
jqx-13f1bbdc12v2ld	реле
jqx-13f1bbdc12v2nil	реле
jqx-13f1bbdc24v1d	реле
jqx-13f1bbdc24v1l	реле
jqx-13f1bbdc24v1ld	реле
jqx-13f1bbdc24v1nil	реле
jqx-13f1bbdc24v2d	реле
jqx-13f1bbdc24v2l	реле
jqx-13f1bbdc24v2ld	реле
jqx-13f1bbdc24v2nil	реле
jqx-13f1bbdc36v1d	реле
jqx-13f1bbdc36v1l	реле
jqx-13f1bbdc36v1ld	реле
jqx-13f1bbdc36v1nil	реле
jqx-13f1bbdc36v2d	реле
jqx-13f1bbdc36v2l	реле
jqx-13f1bbdc36v2ld	реле

jqx-13f1bbdc36v2nil	реле
jqx-13f1bbdc48v1d	реле
jqx-13f1bbdc48v1l	реле
jqx-13f1bbdc48v1ld	реле
jqx-13f1bbdc48v1nil	реле
jqx-13f1bbdc48v2d	реле
jqx-13f1bbdc48v2l	реле
jqx-13f1bbdc48v2ld	реле
jqx-13f1bbdc48v2nil	реле
jqx-13f1caac110v1d	реле
jqx-13f1caac110v1l	реле
jqx-13f1caac110v1ld	реле
jqx-13f1caac110v1nil	реле
jqx-13f1caac110v2d	реле
jqx-13f1caac110v2l	реле
jqx-13f1caac110v2ld	реле
jqx-13f1caac110v2nil	реле
jqx-13f1caac12v1d	реле
jqx-13f1caac12v1l	реле
jqx-13f1caac12v1ld	реле
jqx-13f1caac12v1nil	реле
jqx-13f1caac12v2d	реле
jqx-13f1caac12v2l	реле
jqx-13f1caac12v2ld	реле
jqx-13f1caac12v2nil	реле
jqx-13f1caac24v1d	реле
jqx-13f1caac24v1l	реле
jqx-13f1caac24v1ld	реле

jqx-13f1caac24v1nil	реле
jqx-13f1caac24v2d	реле
jqx-13f1caac24v2l	реле
jqx-13f1caac24v2ld	реле
jqx-13f1caac24v2nil	реле
jqx-13f1caac36v1d	реле
jqx-13f1caac36v1l	реле
jqx-13f1caac36v1ld	реле
jqx-13f1caac36v1nil	реле
jqx-13f1caac36v2d	реле
jqx-13f1caac36v2l	реле
jqx-13f1caac36v2ld	реле
jqx-13f1caac36v2nil	реле
jqx-13f1caac48v1d	реле
jqx-13f1caac48v1l	реле
jqx-13f1caac48v1ld	реле
jqx-13f1caac48v1nil	реле
jqx-13f1caac48v2d	реле
jqx-13f1caac48v2l	реле
jqx-13f1caac48v2ld	реле
jqx-13f1caac48v2nil	реле
jqx-13f1cadc110v1d	реле
jqx-13f1cadc110v1l	реле
jqx-13f1cadc110v1ld	реле
jqx-13f1cadc110v1nil	реле
jqx-13f1cadc110v2d	реле
jqx-13f1cadc110v2l	реле
jqx-13f1cadc110v2ld	реле

jqx-13f1cadc110v2nil	реле
jqx-13f1cadc12v1d	реле
jqx-13f1cadc12v1l	реле
jqx-13f1cadc12v1ld	реле
jqx-13f1cadc12v1nil	реле
jqx-13f1cadc12v2d	реле
jqx-13f1cadc12v2l	реле
jqx-13f1cadc12v2ld	реле
jqx-13f1cadc12v2nil	реле
jqx-13f1cadc24v1d	реле
jqx-13f1cadc24v1l	реле
jqx-13f1cadc24v1ld	реле
jqx-13f1cadc24v1nil	реле
jqx-13f1cadc24v2d	реле
jqx-13f1cadc24v2l	реле
jqx-13f1cadc24v2ld	реле
jqx-13f1cadc24v2nil	реле
jqx-13f1cadc36v1d	реле
jqx-13f1cadc36v1l	реле
jqx-13f1cadc36v1ld	реле
jqx-13f1cadc36v1nil	реле
jqx-13f1cadc36v2d	реле
jqx-13f1cadc36v2l	реле
jqx-13f1cadc36v2ld	реле
jqx-13f1cadc36v2nil	реле
jqx-13f1cadc48v1d	реле
jqx-13f1cadc48v1l	реле
jqx-13f1cadc48v1ld	реле

jqx-13f1cadc48v1nil	реле
jqx-13f1cadc48v2d	реле
jqx-13f1cadc48v2l	реле
jqx-13f1cadc48v2ld	реле
jqx-13f1cadc48v2nil	реле
jqx-13f1cbac110v1d	реле
jqx-13f1cbac110v1l	реле
jqx-13f1cbac110v1ld	реле
jqx-13f1cbac110v1nil	реле
jqx-13f1cbac110v2d	реле
jqx-13f1cbac110v2l	реле
jqx-13f1cbac110v2ld	реле
jqx-13f1cbac110v2nil	реле
jqx-13f1cbac12v1d	реле
jqx-13f1cbac12v1l	реле
jqx-13f1cbac12v1ld	реле
jqx-13f1cbac12v1nil	реле
jqx-13f1cbac12v2d	реле
jqx-13f1cbac12v2l	реле
jqx-13f1cbac12v2ld	реле
jqx-13f1cbac12v2nil	реле
jqx-13f1cbac24v1d	реле
jqx-13f1cbac24v1l	реле
jqx-13f1cbac24v1ld	реле
jqx-13f1cbac24v1nil	реле
jqx-13f1cbac24v2d	реле
jqx-13f1cbac24v2l	реле
jqx-13f1cbac24v2ld	реле

jqx-13f1cbac24v2nil	реле
jqx-13f1cbac36v1d	реле
jqx-13f1cbac36v1l	реле
jqx-13f1cbac36v1ld	реле
jqx-13f1cbac36v1nil	реле
jqx-13f1cbac36v2d	реле
jqx-13f1cbac36v2l	реле
jqx-13f1cbac36v2ld	реле
jqx-13f1cbac36v2nil	реле
jqx-13f1cbac48v1d	реле
jqx-13f1cbac48v1l	реле
jqx-13f1cbac48v1ld	реле
jqx-13f1cbac48v1nil	реле
jqx-13f1cbac48v2d	реле
jqx-13f1cbac48v2l	реле
jqx-13f1cbac48v2ld	реле
jqx-13f1cbac48v2nil	реле
jqx-13f1cbdc110v1d	реле
jqx-13f1cbdc110v1l	реле
jqx-13f1cbdc110v1ld	реле
jqx-13f1cbdc110v1nil	реле
jqx-13f1cbdc110v2d	реле
jqx-13f1cbdc110v2l	реле
jqx-13f1cbdc110v2ld	реле
jqx-13f1cbdc110v2nil	реле
jqx-13f1cbdc12v1d	реле
jqx-13f1cbdc12v1l	реле
jqx-13f1cbdc12v1ld	реле

jqx-13f1cbdc12v1nil	реле
jqx-13f1cbdc12v2d	реле
jqx-13f1cbdc12v2l	реле
jqx-13f1cbdc12v2ld	реле
jqx-13f1cbdc12v2nil	реле
jqx-13f1cbdc24v1d	реле
jqx-13f1cbdc24v1l	реле
jqx-13f1cbdc24v1ld	реле
jqx-13f1cbdc24v1nil	реле
jqx-13f1cbdc24v2d	реле
jqx-13f1cbdc24v2l	реле
jqx-13f1cbdc24v2ld	реле
jqx-13f1cbdc24v2nil	реле
jqx-13f1cbdc36v1d	реле
jqx-13f1cbdc36v1l	реле
jqx-13f1cbdc36v1ld	реле
jqx-13f1cbdc36v1nil	реле
jqx-13f1cbdc36v2d	реле
jqx-13f1cbdc36v2l	реле
jqx-13f1cbdc36v2ld	реле
jqx-13f1cbdc36v2nil	реле
jqx-13f1cbdc48v1d	реле
jqx-13f1cbdc48v1l	реле
jqx-13f1cbdc48v1ld	реле
jqx-13f1cbdc48v1nil	реле
jqx-13f1cbdc48v2d	реле
jqx-13f1cbdc48v2l	реле
jqx-13f1cbdc48v2ld	реле

jqx-13f1cbdc48v2nil	реле
jqx-13f2aaac110v1d	реле
jqx-13f2aaac110v1l	реле
jqx-13f2aaac110v1ld	реле
jqx-13f2aaac110v1nil	реле
jqx-13f2aaac110v2d	реле
jqx-13f2aaac110v2l	реле
jqx-13f2aaac110v2ld	реле
jqx-13f2aaac110v2nil	реле
jqx-13f2aaac12v1d	реле
jqx-13f2aaac12v1l	реле
jqx-13f2aaac12v1ld	реле
jqx-13f2aaac12v1nil	реле
jqx-13f2aaac12v2d	реле
jqx-13f2aaac12v2l	реле
jqx-13f2aaac12v2ld	реле
jqx-13f2aaac12v2nil	реле
jqx-13f2aaac24v1d	реле
jqx-13f2aaac24v1l	реле
jqx-13f2aaac24v1ld	реле
jqx-13f2aaac24v1nil	реле
jqx-13f2aaac24v2d	реле
jqx-13f2aaac24v2l	реле
jqx-13f2aaac24v2ld	реле
jqx-13f2aaac24v2nil	реле
jqx-13f2aaac36v1d	реле
jqx-13f2aaac36v1l	реле
jqx-13f2aaac36v1ld	реле

jqx-13f2aaac36v1nil	реле
jqx-13f2aaac36v2d	реле
jqx-13f2aaac36v2l	реле
jqx-13f2aaac36v2ld	реле
jqx-13f2aaac36v2nil	реле
jqx-13f2aaac48v1d	реле
jqx-13f2aaac48v1l	реле
jqx-13f2aaac48v1ld	реле
jqx-13f2aaac48v1nil	реле
jqx-13f2aaac48v2d	реле
jqx-13f2aaac48v2l	реле
jqx-13f2aaac48v2ld	реле
jqx-13f2aaac48v2nil	реле
jqx-13f2aad110v1d	реле
jqx-13f2aad110v1l	реле
jqx-13f2aad110v1ld	реле
jqx-13f2aad110v1nil	реле
jqx-13f2aad110v2d	реле
jqx-13f2aad110v2l	реле
jqx-13f2aad110v2ld	реле
jqx-13f2aad110v2nil	реле
jqx-13f2aad12v1d	реле
jqx-13f2aad12v1l	реле
jqx-13f2aad12v1ld	реле
jqx-13f2aad12v1nil	реле
jqx-13f2aad12v2d	реле
jqx-13f2aad12v2l	реле
jqx-13f2aad12v2ld	реле

jqx-13f2aacdc12v2nil	реле
jqx-13f2aacdc24v1d	реле
jqx-13f2aacdc24v1l	реле
jqx-13f2aacdc24v1ld	реле
jqx-13f2aacdc24v1nil	реле
jqx-13f2aacdc24v2d	реле
jqx-13f2aacdc24v2l	реле
jqx-13f2aacdc24v2ld	реле
jqx-13f2aacdc24v2nil	реле
jqx-13f2aacdc36v1d	реле
jqx-13f2aacdc36v1l	реле
jqx-13f2aacdc36v1ld	реле
jqx-13f2aacdc36v1nil	реле
jqx-13f2aacdc36v2d	реле
jqx-13f2aacdc36v2l	реле
jqx-13f2aacdc36v2ld	реле
jqx-13f2aacdc36v2nil	реле
jqx-13f2aacdc48v1d	реле
jqx-13f2aacdc48v1l	реле
jqx-13f2aacdc48v1ld	реле
jqx-13f2aacdc48v1nil	реле
jqx-13f2aacdc48v2d	реле
jqx-13f2aacdc48v2l	реле
jqx-13f2aacdc48v2ld	реле
jqx-13f2aacdc48v2nil	реле
jqx-13f2abac110v1d	реле
jqx-13f2abac110v1l	реле
jqx-13f2abac110v1ld	реле

jqx-13f2abac110v1nil	реле
jqx-13f2abac110v2d	реле
jqx-13f2abac110v2l	реле
jqx-13f2abac110v2ld	реле
jqx-13f2abac110v2nil	реле
jqx-13f2abac12v1d	реле
jqx-13f2abac12v1l	реле
jqx-13f2abac12v1ld	реле
jqx-13f2abac12v1nil	реле
jqx-13f2abac12v2d	реле
jqx-13f2abac12v2l	реле
jqx-13f2abac12v2ld	реле
jqx-13f2abac12v2nil	реле
jqx-13f2abac24v1d	реле
jqx-13f2abac24v1l	реле
jqx-13f2abac24v1ld	реле
jqx-13f2abac24v1nil	реле
jqx-13f2abac24v2d	реле
jqx-13f2abac24v2l	реле
jqx-13f2abac24v2ld	реле
jqx-13f2abac24v2nil	реле
jqx-13f2abac36v1d	реле
jqx-13f2abac36v1l	реле
jqx-13f2abac36v1ld	реле
jqx-13f2abac36v1nil	реле
jqx-13f2abac36v2d	реле
jqx-13f2abac36v2l	реле
jqx-13f2abac36v2ld	реле

jqx-13f2abac36v2nil	реле
jqx-13f2abac48v1d	реле
jqx-13f2abac48v1l	реле
jqx-13f2abac48v1ld	реле
jqx-13f2abac48v1nil	реле
jqx-13f2abac48v2d	реле
jqx-13f2abac48v2l	реле
jqx-13f2abac48v2ld	реле
jqx-13f2abac48v2nil	реле
jqx-13f2abdc110v1d	реле
jqx-13f2abdc110v1l	реле
jqx-13f2abdc110v1ld	реле
jqx-13f2abdc110v1nil	реле
jqx-13f2abdc110v2d	реле
jqx-13f2abdc110v2l	реле
jqx-13f2abdc110v2ld	реле
jqx-13f2abdc110v2nil	реле
jqx-13f2abdc12v1d	реле
jqx-13f2abdc12v1l	реле
jqx-13f2abdc12v1ld	реле
jqx-13f2abdc12v1nil	реле
jqx-13f2abdc12v2d	реле
jqx-13f2abdc12v2l	реле
jqx-13f2abdc12v2ld	реле
jqx-13f2abdc12v2nil	реле
jqx-13f2abdc24v1d	реле
jqx-13f2abdc24v1l	реле
jqx-13f2abdc24v1ld	реле

jqx-13f2abdc24v1nil	реле
jqx-13f2abdc24v2d	реле
jqx-13f2abdc24v2l	реле
jqx-13f2abdc24v2ld	реле
jqx-13f2abdc24v2nil	реле
jqx-13f2abdc36v1d	реле
jqx-13f2abdc36v1l	реле
jqx-13f2abdc36v1ld	реле
jqx-13f2abdc36v1nil	реле
jqx-13f2abdc36v2d	реле
jqx-13f2abdc36v2l	реле
jqx-13f2abdc36v2ld	реле
jqx-13f2abdc36v2nil	реле
jqx-13f2abdc48v1d	реле
jqx-13f2abdc48v1l	реле
jqx-13f2abdc48v1ld	реле
jqx-13f2abdc48v1nil	реле
jqx-13f2abdc48v2d	реле
jqx-13f2abdc48v2l	реле
jqx-13f2abdc48v2ld	реле
jqx-13f2abdc48v2nil	реле
jqx-13f2baac110v1d	реле
jqx-13f2baac110v1l	реле
jqx-13f2baac110v1ld	реле
jqx-13f2baac110v1nil	реле
jqx-13f2baac110v2d	реле
jqx-13f2baac110v2l	реле
jqx-13f2baac110v2ld	реле

jqx-13f2baac110v2nil	реле
jqx-13f2baac12v1d	реле
jqx-13f2baac12v1l	реле
jqx-13f2baac12v1ld	реле
jqx-13f2baac12v1nil	реле
jqx-13f2baac12v2d	реле
jqx-13f2baac12v2l	реле
jqx-13f2baac12v2ld	реле
jqx-13f2baac12v2nil	реле
jqx-13f2baac24v1d	реле
jqx-13f2baac24v1l	реле
jqx-13f2baac24v1ld	реле
jqx-13f2baac24v1nil	реле
jqx-13f2baac24v2d	реле
jqx-13f2baac24v2l	реле
jqx-13f2baac24v2ld	реле
jqx-13f2baac24v2nil	реле
jqx-13f2baac36v1d	реле
jqx-13f2baac36v1l	реле
jqx-13f2baac36v1ld	реле
jqx-13f2baac36v1nil	реле
jqx-13f2baac36v2d	реле
jqx-13f2baac36v2l	реле
jqx-13f2baac36v2ld	реле
jqx-13f2baac36v2nil	реле
jqx-13f2baac48v1d	реле
jqx-13f2baac48v1l	реле
jqx-13f2baac48v1ld	реле

jqx-13f2baac48v1nil	реле
jqx-13f2baac48v2d	реле
jqx-13f2baac48v2l	реле
jqx-13f2baac48v2ld	реле
jqx-13f2baac48v2nil	реле
jqx-13f2badc110v1d	реле
jqx-13f2badc110v1l	реле
jqx-13f2badc110v1ld	реле
jqx-13f2badc110v1nil	реле
jqx-13f2badc110v2d	реле
jqx-13f2badc110v2l	реле
jqx-13f2badc110v2ld	реле
jqx-13f2badc110v2nil	реле
jqx-13f2badc12v1d	реле
jqx-13f2badc12v1l	реле
jqx-13f2badc12v1ld	реле
jqx-13f2badc12v1nil	реле
jqx-13f2badc12v2d	реле
jqx-13f2badc12v2l	реле
jqx-13f2badc12v2ld	реле
jqx-13f2badc12v2nil	реле
jqx-13f2badc24v1d	реле
jqx-13f2badc24v1l	реле
jqx-13f2badc24v1ld	реле
jqx-13f2badc24v1nil	реле
jqx-13f2badc24v2d	реле
jqx-13f2badc24v2l	реле
jqx-13f2badc24v2ld	реле

jqx-13f2badc24v2nil	реле
jqx-13f2badc36v1d	реле
jqx-13f2badc36v1l	реле
jqx-13f2badc36v1ld	реле
jqx-13f2badc36v1nil	реле
jqx-13f2badc36v2d	реле
jqx-13f2badc36v2l	реле
jqx-13f2badc36v2ld	реле
jqx-13f2badc36v2nil	реле
jqx-13f2badc48v1d	реле
jqx-13f2badc48v1l	реле
jqx-13f2badc48v1ld	реле
jqx-13f2badc48v1nil	реле
jqx-13f2badc48v2d	реле
jqx-13f2badc48v2l	реле
jqx-13f2badc48v2ld	реле
jqx-13f2badc48v2nil	реле
jqx-13f2bbac110v1d	реле
jqx-13f2bbac110v1l	реле
jqx-13f2bbac110v1ld	реле
jqx-13f2bbac110v1nil	реле
jqx-13f2bbac110v2d	реле
jqx-13f2bbac110v2l	реле
jqx-13f2bbac110v2ld	реле
jqx-13f2bbac110v2nil	реле
jqx-13f2bbac12v1d	реле
jqx-13f2bbac12v1l	реле
jqx-13f2bbac12v1ld	реле

jqx-13f2bbac12v1nil	реле
jqx-13f2bbac12v2d	реле
jqx-13f2bbac12v2l	реле
jqx-13f2bbac12v2ld	реле
jqx-13f2bbac12v2nil	реле
jqx-13f2bbac24v1d	реле
jqx-13f2bbac24v1l	реле
jqx-13f2bbac24v1ld	реле
jqx-13f2bbac24v1nil	реле
jqx-13f2bbac24v2d	реле
jqx-13f2bbac24v2l	реле
jqx-13f2bbac24v2ld	реле
jqx-13f2bbac24v2nil	реле
jqx-13f2bbac36v1d	реле
jqx-13f2bbac36v1l	реле
jqx-13f2bbac36v1ld	реле
jqx-13f2bbac36v1nil	реле
jqx-13f2bbac36v2d	реле
jqx-13f2bbac36v2l	реле
jqx-13f2bbac36v2ld	реле
jqx-13f2bbac36v2nil	реле
jqx-13f2bbac48v1d	реле
jqx-13f2bbac48v1l	реле
jqx-13f2bbac48v1ld	реле
jqx-13f2bbac48v1nil	реле
jqx-13f2bbac48v2d	реле
jqx-13f2bbac48v2l	реле
jqx-13f2bbac48v2ld	реле

jqx-13f2bbac48v2nil	реле
jqx-13f2bbdc110v1d	реле
jqx-13f2bbdc110v1l	реле
jqx-13f2bbdc110v1d	реле
jqx-13f2bbdc110v1nil	реле
jqx-13f2bbdc110v2d	реле
jqx-13f2bbdc110v2l	реле
jqx-13f2bbdc110v2d	реле
jqx-13f2bbdc110v2nil	реле
jqx-13f2bbdc12v1d	реле
jqx-13f2bbdc12v1l	реле
jqx-13f2bbdc12v1d	реле
jqx-13f2bbdc12v1nil	реле
jqx-13f2bbdc12v2d	реле
jqx-13f2bbdc12v2l	реле
jqx-13f2bbdc12v2d	реле
jqx-13f2bbdc12v2nil	реле
jqx-13f2bbdc24v1d	реле
jqx-13f2bbdc24v1l	реле
jqx-13f2bbdc24v1d	реле
jqx-13f2bbdc24v1nil	реле
jqx-13f2bbdc24v2d	реле
jqx-13f2bbdc24v2l	реле
jqx-13f2bbdc24v2d	реле
jqx-13f2bbdc24v2nil	реле
jqx-13f2bbdc36v1d	реле
jqx-13f2bbdc36v1l	реле
jqx-13f2bbdc36v1d	реле

jqx-13f2bbdc36v1nil	реле
jqx-13f2bbdc36v2d	реле
jqx-13f2bbdc36v2l	реле
jqx-13f2bbdc36v2ld	реле
jqx-13f2bbdc36v2nil	реле
jqx-13f2bbdc48v1d	реле
jqx-13f2bbdc48v1l	реле
jqx-13f2bbdc48v1ld	реле
jqx-13f2bbdc48v1nil	реле
jqx-13f2bbdc48v2d	реле
jqx-13f2bbdc48v2l	реле
jqx-13f2bbdc48v2ld	реле
jqx-13f2bbdc48v2nil	реле
jqx-13f2caac110v1d	реле
jqx-13f2caac110v1l	реле
jqx-13f2caac110v1ld	реле
jqx-13f2caac110v1nil	реле
jqx-13f2caac110v2d	реле
jqx-13f2caac110v2l	реле
jqx-13f2caac110v2ld	реле
jqx-13f2caac110v2nil	реле
jqx-13f2caac12v1d	реле
jqx-13f2caac12v1l	реле
jqx-13f2caac12v1ld	реле
jqx-13f2caac12v1nil	реле
jqx-13f2caac12v2d	реле
jqx-13f2caac12v2l	реле
jqx-13f2caac12v2ld	реле

jqx-13f2caac12v2nil	реле
jqx-13f2caac24v1d	реле
jqx-13f2caac24v1l	реле
jqx-13f2caac24v1ld	реле
jqx-13f2caac24v1nil	реле
jqx-13f2caac24v2d	реле
jqx-13f2caac24v2l	реле
jqx-13f2caac24v2ld	реле
jqx-13f2caac24v2nil	реле
jqx-13f2caac36v1d	реле
jqx-13f2caac36v1l	реле
jqx-13f2caac36v1ld	реле
jqx-13f2caac36v1nil	реле
jqx-13f2caac36v2d	реле
jqx-13f2caac36v2l	реле
jqx-13f2caac36v2ld	реле
jqx-13f2caac36v2nil	реле
jqx-13f2caac48v1d	реле
jqx-13f2caac48v1l	реле
jqx-13f2caac48v1ld	реле
jqx-13f2caac48v1nil	реле
jqx-13f2caac48v2d	реле
jqx-13f2caac48v2l	реле
jqx-13f2caac48v2ld	реле
jqx-13f2caac48v2nil	реле
jqx-13f2cadc110v1d	реле
jqx-13f2cadc110v1l	реле
jqx-13f2cadc110v1ld	реле

jqx-13f2cadc110v1nil	реле
jqx-13f2cadc110v2d	реле
jqx-13f2cadc110v2l	реле
jqx-13f2cadc110v2ld	реле
jqx-13f2cadc110v2nil	реле
jqx-13f2cadc12v1d	реле
jqx-13f2cadc12v1l	реле
jqx-13f2cadc12v1ld	реле
jqx-13f2cadc12v1nil	реле
jqx-13f2cadc12v2d	реле
jqx-13f2cadc12v2l	реле
jqx-13f2cadc12v2ld	реле
jqx-13f2cadc12v2nil	реле
jqx-13f2cadc24v1d	реле
jqx-13f2cadc24v1l	реле
jqx-13f2cadc24v1ld	реле
jqx-13f2cadc24v1nil	реле
jqx-13f2cadc24v2d	реле
jqx-13f2cadc24v2l	реле
jqx-13f2cadc24v2ld	реле
jqx-13f2cadc24v2nil	реле
jqx-13f2cadc36v1d	реле
jqx-13f2cadc36v1l	реле
jqx-13f2cadc36v1ld	реле
jqx-13f2cadc36v1nil	реле
jqx-13f2cadc36v2d	реле
jqx-13f2cadc36v2l	реле
jqx-13f2cadc36v2ld	реле

jqx-13f2cad36v2nil	реле
jqx-13f2cad48v1d	реле
jqx-13f2cad48v1l	реле
jqx-13f2cad48v1ld	реле
jqx-13f2cad48v1nil	реле
jqx-13f2cad48v2d	реле
jqx-13f2cad48v2l	реле
jqx-13f2cad48v2ld	реле
jqx-13f2cad48v2nil	реле
jqx-13f2cbac110v1d	реле
jqx-13f2cbac110v1l	реле
jqx-13f2cbac110v1ld	реле
jqx-13f2cbac110v1nil	реле
jqx-13f2cbac110v2d	реле
jqx-13f2cbac110v2l	реле
jqx-13f2cbac110v2ld	реле
jqx-13f2cbac110v2nil	реле
jqx-13f2cbac12v1d	реле
jqx-13f2cbac12v1l	реле
jqx-13f2cbac12v1ld	реле
jqx-13f2cbac12v1nil	реле
jqx-13f2cbac12v2d	реле
jqx-13f2cbac12v2l	реле
jqx-13f2cbac12v2ld	реле
jqx-13f2cbac12v2nil	реле
jqx-13f2cbac24v1d	реле
jqx-13f2cbac24v1l	реле
jqx-13f2cbac24v1ld	реле

jqx-13f2cbac24v1nil	реле
jqx-13f2cbac24v2d	реле
jqx-13f2cbac24v2l	реле
jqx-13f2cbac24v2ld	реле
jqx-13f2cbac24v2nil	реле
jqx-13f2cbac36v1d	реле
jqx-13f2cbac36v1l	реле
jqx-13f2cbac36v1ld	реле
jqx-13f2cbac36v1nil	реле
jqx-13f2cbac36v2d	реле
jqx-13f2cbac36v2l	реле
jqx-13f2cbac36v2ld	реле
jqx-13f2cbac36v2nil	реле
jqx-13f2cbac48v1d	реле
jqx-13f2cbac48v1l	реле
jqx-13f2cbac48v1ld	реле
jqx-13f2cbac48v1nil	реле
jqx-13f2cbac48v2d	реле
jqx-13f2cbac48v2l	реле
jqx-13f2cbac48v2ld	реле
jqx-13f2cbac48v2nil	реле
jqx-13f2cbdc110v1d	реле
jqx-13f2cbdc110v1l	реле
jqx-13f2cbdc110v1ld	реле
jqx-13f2cbdc110v1nil	реле
jqx-13f2cbdc110v2d	реле
jqx-13f2cbdc110v2l	реле
jqx-13f2cbdc110v2ld	реле

jqx-13f2cbdc110v2nil	реле
jqx-13f2cbdc12v1d	реле
jqx-13f2cbdc12v1l	реле
jqx-13f2cbdc12v1ld	реле
jqx-13f2cbdc12v1nil	реле
jqx-13f2cbdc12v2d	реле
jqx-13f2cbdc12v2l	реле
jqx-13f2cbdc12v2ld	реле
jqx-13f2cbdc12v2nil	реле
jqx-13f2cbdc24v1d	реле
jqx-13f2cbdc24v1l	реле
jqx-13f2cbdc24v1ld	реле
jqx-13f2cbdc24v1nil	реле
jqx-13f2cbdc24v2d	реле
jqx-13f2cbdc24v2l	реле
jqx-13f2cbdc24v2ld	реле
jqx-13f2cbdc24v2nil	реле
jqx-13f2cbdc36v1d	реле
jqx-13f2cbdc36v1l	реле
jqx-13f2cbdc36v1ld	реле
jqx-13f2cbdc36v1nil	реле
jqx-13f2cbdc36v2d	реле
jqx-13f2cbdc36v2l	реле
jqx-13f2cbdc36v2ld	реле
jqx-13f2cbdc36v2nil	реле
jqx-13f2cbdc48v1d	реле
jqx-13f2cbdc48v1l	реле
jqx-13f2cbdc48v1ld	реле

jqx-13f2cbdc48v1nil	реле
jqx-13f2cbdc48v2d	реле
jqx-13f2cbdc48v2l	реле
jqx-13f2cbdc48v2ld	реле
jqx-13f2cbdc48v2nil	реле
jqx-13f3caac110v1d	реле
jqx-13f3caac110v1l	реле
jqx-13f3caac110v1ld	реле
jqx-13f3caac110v1nil	реле
jqx-13f3caac110v2d	реле
jqx-13f3caac110v2l	реле
jqx-13f3caac110v2ld	реле
jqx-13f3caac110v2nil	реле
jqx-13f3caac12v1d	реле
jqx-13f3caac12v1l	реле
jqx-13f3caac12v1ld	реле
jqx-13f3caac12v1nil	реле
jqx-13f3caac12v2d	реле
jqx-13f3caac12v2l	реле
jqx-13f3caac12v2ld	реле
jqx-13f3caac12v2nil	реле
jqx-13f3caac24v1d	реле
jqx-13f3caac24v1l	реле
jqx-13f3caac24v1ld	реле
jqx-13f3caac24v1nil	реле
jqx-13f3caac24v2d	реле
jqx-13f3caac24v2l	реле
jqx-13f3caac24v2ld	реле

jqx-13f3caac24v2nil	реле
jqx-13f3caac36v1d	реле
jqx-13f3caac36v1l	реле
jqx-13f3caac36v1ld	реле
jqx-13f3caac36v1nil	реле
jqx-13f3caac36v2d	реле
jqx-13f3caac36v2l	реле
jqx-13f3caac36v2ld	реле
jqx-13f3caac36v2nil	реле
jqx-13f3caac48v1d	реле
jqx-13f3caac48v1l	реле
jqx-13f3caac48v1ld	реле
jqx-13f3caac48v1nil	реле
jqx-13f3caac48v2d	реле
jqx-13f3caac48v2l	реле
jqx-13f3caac48v2ld	реле
jqx-13f3caac48v2nil	реле
jqx-13f3cadc110v1d	реле
jqx-13f3cadc110v1l	реле
jqx-13f3cadc110v1ld	реле
jqx-13f3cadc110v1nil	реле
jqx-13f3cadc110v2d	реле
jqx-13f3cadc110v2l	реле
jqx-13f3cadc110v2ld	реле
jqx-13f3cadc110v2nil	реле
jqx-13f3cadc12v1d	реле
jqx-13f3cadc12v1l	реле
jqx-13f3cadc12v1ld	реле

jqx-13f3cadc12v1nil	реле
jqx-13f3cadc12v2d	реле
jqx-13f3cadc12v2l	реле
jqx-13f3cadc12v2ld	реле
jqx-13f3cadc12v2nil	реле
jqx-13f3cadc24v1d	реле
jqx-13f3cadc24v1l	реле
jqx-13f3cadc24v1ld	реле
jqx-13f3cadc24v1nil	реле
jqx-13f3cadc24v2d	реле
jqx-13f3cadc24v2l	реле
jqx-13f3cadc24v2ld	реле
jqx-13f3cadc24v2nil	реле
jqx-13f3cadc36v1d	реле
jqx-13f3cadc36v1l	реле
jqx-13f3cadc36v1ld	реле
jqx-13f3cadc36v1nil	реле
jqx-13f3cadc36v2d	реле
jqx-13f3cadc36v2l	реле
jqx-13f3cadc36v2ld	реле
jqx-13f3cadc36v2nil	реле
jqx-13f3cadc48v1d	реле
jqx-13f3cadc48v1l	реле
jqx-13f3cadc48v1ld	реле
jqx-13f3cadc48v1nil	реле
jqx-13f3cadc48v2d	реле
jqx-13f3cadc48v2l	реле
jqx-13f3cadc48v2ld	реле

jqx-13f3cadc48v2nil	реле
jqx-13f3cbac110v1d	реле
jqx-13f3cbac110v1l	реле
jqx-13f3cbac110v1ld	реле
jqx-13f3cbac110v1nil	реле
jqx-13f3cbac110v2d	реле
jqx-13f3cbac110v2l	реле
jqx-13f3cbac110v2ld	реле
jqx-13f3cbac110v2nil	реле
jqx-13f3cbac12v1d	реле
jqx-13f3cbac12v1l	реле
jqx-13f3cbac12v1ld	реле
jqx-13f3cbac12v1nil	реле
jqx-13f3cbac12v2d	реле
jqx-13f3cbac12v2l	реле
jqx-13f3cbac12v2ld	реле
jqx-13f3cbac12v2nil	реле
jqx-13f3cbac24v1d	реле
jqx-13f3cbac24v1l	реле
jqx-13f3cbac24v1ld	реле
jqx-13f3cbac24v1nil	реле
jqx-13f3cbac24v2d	реле
jqx-13f3cbac24v2l	реле
jqx-13f3cbac24v2ld	реле
jqx-13f3cbac24v2nil	реле
jqx-13f3cbac36v1d	реле
jqx-13f3cbac36v1l	реле
jqx-13f3cbac36v1ld	реле

jqx-13f3cbac36v1nil	реле
jqx-13f3cbac36v2d	реле
jqx-13f3cbac36v2l	реле
jqx-13f3cbac36v2ld	реле
jqx-13f3cbac36v2nil	реле
jqx-13f3cbac48v1d	реле
jqx-13f3cbac48v1l	реле
jqx-13f3cbac48v1ld	реле
jqx-13f3cbac48v1nil	реле
jqx-13f3cbac48v2d	реле
jqx-13f3cbac48v2l	реле
jqx-13f3cbac48v2ld	реле
jqx-13f3cbac48v2nil	реле
jqx-13f3cbdc110v1d	реле
jqx-13f3cbdc110v1l	реле
jqx-13f3cbdc110v1ld	реле
jqx-13f3cbdc110v1nil	реле
jqx-13f3cbdc110v2d	реле
jqx-13f3cbdc110v2l	реле
jqx-13f3cbdc110v2ld	реле
jqx-13f3cbdc110v2nil	реле
jqx-13f3cbdc12v1d	реле
jqx-13f3cbdc12v1l	реле
jqx-13f3cbdc12v1ld	реле
jqx-13f3cbdc12v1nil	реле
jqx-13f3cbdc12v2d	реле
jqx-13f3cbdc12v2l	реле
jqx-13f3cbdc12v2ld	реле

jqx-13f3cbdc12v2nil	реле
jqx-13f3cbdc24v1d	реле
jqx-13f3cbdc24v1l	реле
jqx-13f3cbdc24v1ld	реле
jqx-13f3cbdc24v1nil	реле
jqx-13f3cbdc24v2d	реле
jqx-13f3cbdc24v2l	реле
jqx-13f3cbdc24v2ld	реле
jqx-13f3cbdc24v2nil	реле
jqx-13f3cbdc36v1d	реле
jqx-13f3cbdc36v1l	реле
jqx-13f3cbdc36v1ld	реле
jqx-13f3cbdc36v1nil	реле
jqx-13f3cbdc36v2d	реле
jqx-13f3cbdc36v2l	реле
jqx-13f3cbdc36v2ld	реле
jqx-13f3cbdc36v2nil	реле
jqx-13f3cbdc48v1d	реле
jqx-13f3cbdc48v1l	реле
jqx-13f3cbdc48v1ld	реле
jqx-13f3cbdc48v1nil	реле
jqx-13f3cbdc48v2d	реле
jqx-13f3cbdc48v2l	реле
jqx-13f3cbdc48v2ld	реле
jqx-13f3cbdc48v2nil	реле
jqx-13f4саас110v1d	реле
jqx-13f4саас110v1l	реле
jqx-13f4саас110v1ld	реле

jqx-13f4caac110v1nil	реле
jqx-13f4caac110v2d	реле
jqx-13f4caac110v2l	реле
jqx-13f4caac110v2ld	реле
jqx-13f4caac110v2nil	реле
jqx-13f4caac12v1d	реле
jqx-13f4caac12v1l	реле
jqx-13f4caac12v1ld	реле
jqx-13f4caac12v1nil	реле
jqx-13f4caac12v2d	реле
jqx-13f4caac12v2l	реле
jqx-13f4caac12v2ld	реле
jqx-13f4caac12v2nil	реле
jqx-13f4caac24v1d	реле
jqx-13f4caac24v1l	реле
jqx-13f4caac24v1ld	реле
jqx-13f4caac24v1nil	реле
jqx-13f4caac24v2d	реле
jqx-13f4caac24v2l	реле
jqx-13f4caac24v2ld	реле
jqx-13f4caac24v2nil	реле
jqx-13f4caac36v1d	реле
jqx-13f4caac36v1l	реле
jqx-13f4caac36v1ld	реле
jqx-13f4caac36v1nil	реле
jqx-13f4caac36v2d	реле
jqx-13f4caac36v2l	реле
jqx-13f4caac36v2ld	реле

jqx-13f4caac36v2nil	реле
jqx-13f4caac48v1d	реле
jqx-13f4caac48v1l	реле
jqx-13f4caac48v1ld	реле
jqx-13f4caac48v1nil	реле
jqx-13f4caac48v2d	реле
jqx-13f4caac48v2l	реле
jqx-13f4caac48v2ld	реле
jqx-13f4caac48v2nil	реле
jqx-13f4cadc110v1d	реле
jqx-13f4cadc110v1l	реле
jqx-13f4cadc110v1ld	реле
jqx-13f4cadc110v1nil	реле
jqx-13f4cadc110v2d	реле
jqx-13f4cadc110v2l	реле
jqx-13f4cadc110v2ld	реле
jqx-13f4cadc110v2nil	реле
jqx-13f4cadc12v1d	реле
jqx-13f4cadc12v1l	реле
jqx-13f4cadc12v1ld	реле
jqx-13f4cadc12v1nil	реле
jqx-13f4cadc12v2d	реле
jqx-13f4cadc12v2l	реле
jqx-13f4cadc12v2ld	реле
jqx-13f4cadc12v2nil	реле
jqx-13f4cadc24v1d	реле
jqx-13f4cadc24v1l	реле
jqx-13f4cadc24v1ld	реле

jqx-13f4cadc24v1nil	реле
jqx-13f4cadc24v2d	реле
jqx-13f4cadc24v2l	реле
jqx-13f4cadc24v2ld	реле
jqx-13f4cadc24v2nil	реле
jqx-13f4cadc36v1d	реле
jqx-13f4cadc36v1l	реле
jqx-13f4cadc36v1ld	реле
jqx-13f4cadc36v1nil	реле
jqx-13f4cadc36v2d	реле
jqx-13f4cadc36v2l	реле
jqx-13f4cadc36v2ld	реле
jqx-13f4cadc36v2nil	реле
jqx-13f4cadc48v1d	реле
jqx-13f4cadc48v1l	реле
jqx-13f4cadc48v1ld	реле
jqx-13f4cadc48v1nil	реле
jqx-13f4cadc48v2d	реле
jqx-13f4cadc48v2l	реле
jqx-13f4cadc48v2ld	реле
jqx-13f4cadc48v2nil	реле
jqx-13f4cbac110v1d	реле
jqx-13f4cbac110v1l	реле
jqx-13f4cbac110v1ld	реле
jqx-13f4cbac110v1nil	реле
jqx-13f4cbac110v2d	реле
jqx-13f4cbac110v2l	реле
jqx-13f4cbac110v2ld	реле

jqx-13f4cbac110v2nil	реле
jqx-13f4cbac12v1d	реле
jqx-13f4cbac12v1l	реле
jqx-13f4cbac12v1ld	реле
jqx-13f4cbac12v1nil	реле
jqx-13f4cbac12v2d	реле
jqx-13f4cbac12v2l	реле
jqx-13f4cbac12v2ld	реле
jqx-13f4cbac12v2nil	реле
jqx-13f4cbac24v1d	реле
jqx-13f4cbac24v1l	реле
jqx-13f4cbac24v1ld	реле
jqx-13f4cbac24v1nil	реле
jqx-13f4cbac24v2d	реле
jqx-13f4cbac24v2l	реле
jqx-13f4cbac24v2ld	реле
jqx-13f4cbac24v2nil	реле
jqx-13f4cbac36v1d	реле
jqx-13f4cbac36v1l	реле
jqx-13f4cbac36v1ld	реле
jqx-13f4cbac36v1nil	реле
jqx-13f4cbac36v2d	реле
jqx-13f4cbac36v2l	реле
jqx-13f4cbac36v2ld	реле
jqx-13f4cbac36v2nil	реле
jqx-13f4cbac48v1d	реле
jqx-13f4cbac48v1l	реле
jqx-13f4cbac48v1ld	реле

jqx-13f4cbac48v1nil	реле
jqx-13f4cbac48v2d	реле
jqx-13f4cbac48v2l	реле
jqx-13f4cbac48v2ld	реле
jqx-13f4cbac48v2nil	реле
jqx-13f4cbdc110v1d	реле
jqx-13f4cbdc110v1l	реле
jqx-13f4cbdc110v1ld	реле
jqx-13f4cbdc110v1nil	реле
jqx-13f4cbdc110v2d	реле
jqx-13f4cbdc110v2l	реле
jqx-13f4cbdc110v2ld	реле
jqx-13f4cbdc110v2nil	реле
jqx-13f4cbdc12v1d	реле
jqx-13f4cbdc12v1l	реле
jqx-13f4cbdc12v1ld	реле
jqx-13f4cbdc12v1nil	реле
jqx-13f4cbdc12v2d	реле
jqx-13f4cbdc12v2l	реле
jqx-13f4cbdc12v2ld	реле
jqx-13f4cbdc12v2nil	реле
jqx-13f4cbdc24v1d	реле
jqx-13f4cbdc24v1l	реле
jqx-13f4cbdc24v1ld	реле
jqx-13f4cbdc24v1nil	реле
jqx-13f4cbdc24v2d	реле
jqx-13f4cbdc24v2l	реле
jqx-13f4cbdc24v2ld	реле

jqx-13f4cbdc24v2nil	реле
jqx-13f4cbdc36v1d	реле
jqx-13f4cbdc36v1l	реле
jqx-13f4cbdc36v1ld	реле
jqx-13f4cbdc36v1nil	реле
jqx-13f4cbdc36v2d	реле
jqx-13f4cbdc36v2l	реле
jqx-13f4cbdc36v2ld	реле
jqx-13f4cbdc36v2nil	реле
jqx-13f4cbdc48v1d	реле
jqx-13f4cbdc48v1l	реле
jqx-13f4cbdc48v1ld	реле
jqx-13f4cbdc48v1nil	реле
jqx-13f4cbdc48v2d	реле
jqx-13f4cbdc48v2l	реле
jqx-13f4cbdc48v2ld	реле
jqx-13f4cbdc48v2nil	реле
jqx-140ff	etc1 [list of unclassified manufacturers], double-pole, 10a, boar
jqx-141ff	реле
jqx-141ff/005dnlnilg	реле
jqx-141ff/005dnlnilnil	реле
jqx-141ff/005dnlpg	реле
jqx-141ff/005dnlpnil	реле
jqx-141ff/005dsnilg	реле
jqx-141ff/005dsnilnil	реле
jqx-141ff/005dspg	реле
jqx-141ff/005dspnil	реле
jqx-141ff/005hnilnilg	реле

jqx-141ff/005hnilnilnil	реле
jqx-141ff/005hnilpg	реле
jqx-141ff/005hnilpnil	реле
jqx-141ff/005hsnilg	реле
jqx-141ff/005hsnilnil	реле
jqx-141ff/005hspg	реле
jqx-141ff/005hspnil	реле
jqx-141ff/005znilnilg	реле
jqx-141ff/005znilnilnil	реле
jqx-141ff/005znilpg	реле
jqx-141ff/005znilpnil	реле
jqx-141ff/005zsnilg	реле
jqx-141ff/005zsnilnil	реле
jqx-141ff/005zspg	реле
jqx-141ff/005zspnil	реле
jqx-141ff/006dnilnilg	реле
jqx-141ff/006dnilnilnil	реле
jqx-141ff/006dnilpg	реле
jqx-141ff/006dnilpnil	реле
jqx-141ff/006dsnilg	реле
jqx-141ff/006dsnilnil	реле
jqx-141ff/006dspg	реле
jqx-141ff/006dspnil	реле
jqx-141ff/006hnilnilg	реле
jqx-141ff/006hnilnilnil	реле
jqx-141ff/006hnilpg	реле
jqx-141ff/006hnilpnil	реле
jqx-141ff/006hsnilg	реле

jqx-141ff/006hsnilnil	реле
jqx-141ff/006hspg	реле
jqx-141ff/006hsnil	реле
jqx-141ff/006znilnilg	реле
jqx-141ff/006znilnilnil	реле
jqx-141ff/006znilpg	реле
jqx-141ff/006znilpnil	реле
jqx-141ff/006zsnilg	реле
jqx-141ff/006zsnilnil	реле
jqx-141ff/006zspg	реле
jqx-141ff/006zspnil	реле
jqx-141ff/009dnilnilg	реле
jqx-141ff/009dnilnilnil	реле
jqx-141ff/009dnilpg	реле
jqx-141ff/009dnilpnil	реле
jqx-141ff/009dsnilg	реле
jqx-141ff/009dsnilnil	реле
jqx-141ff/009dspg	реле
jqx-141ff/009dspnil	реле
jqx-141ff/009hnilnilg	реле
jqx-141ff/009hnilnilnil	реле
jqx-141ff/009hnilpg	реле
jqx-141ff/009hnilpnil	реле
jqx-141ff/009hsnilg	реле
jqx-141ff/009hsnilnil	реле
jqx-141ff/009hspg	реле
jqx-141ff/009hsnil	реле
jqx-141ff/009znilnilg	реле

jqx-141ff/009znlnlnil	реле
jqx-141ff/009znlnlpg	реле
jqx-141ff/009znlnpnil	реле
jqx-141ff/009zsnlilg	реле
jqx-141ff/009zsnlnil	реле
jqx-141ff/009zspg	реле
jqx-141ff/009zspnil	реле
jqx-141ff/012dnlnilg	реле
jqx-141ff/012dnlnlnil	реле
jqx-141ff/012dnlnlpg	реле
jqx-141ff/012dnlnpnil	реле
jqx-141ff/012dsnlilg	реле
jqx-141ff/012dsnlnil	реле
jqx-141ff/012dspg	реле
jqx-141ff/012dspnil	реле
jqx-141ff/012hnlilg	реле
jqx-141ff/012hnllnil	реле
jqx-141ff/012hnlilpg	реле
jqx-141ff/012hnlipnil	реле
jqx-141ff/012hsnlilg	реле
jqx-141ff/012hsnlnil	реле
jqx-141ff/012hspg	реле
jqx-141ff/012hspnil	реле
jqx-141ff/012znlnilg	реле
jqx-141ff/012znlnlnil	реле
jqx-141ff/012znlnlpg	реле
jqx-141ff/012znlnpnil	реле
jqx-141ff/012zsnlilg	реле

jqx-141ff/012zsnlnil	реле
jqx-141ff/012zspg	реле
jqx-141ff/012zspnil	реле
jqx-141ff/018dnlnilg	реле
jqx-141ff/018dnlnlnil	реле
jqx-141ff/018dnlnpg	реле
jqx-141ff/018dnlnpnil	реле
jqx-141ff/018dsnilg	реле
jqx-141ff/018dsnlnil	реле
jqx-141ff/018dspg	реле
jqx-141ff/018dspnil	реле
jqx-141ff/018hlnlnilg	реле
jqx-141ff/018hlnlnlnil	реле
jqx-141ff/018hlnlnpg	реле
jqx-141ff/018hlnlnpnil	реле
jqx-141ff/018hsnilg	реле
jqx-141ff/018hsnlnil	реле
jqx-141ff/018hspg	реле
jqx-141ff/018hspnil	реле
jqx-141ff/018zlnlnilg	реле
jqx-141ff/018zlnlnlnil	реле
jqx-141ff/018zlnlnpg	реле
jqx-141ff/018zlnlnpnil	реле
jqx-141ff/018zsnlilg	реле
jqx-141ff/018zsnlnil	реле
jqx-141ff/018zspg	реле
jqx-141ff/018zspnil	реле
jqx-141ff/024dnlnilg	реле

jqx-141ff/024dnlnilnil	реле
jqx-141ff/024dnlnlpg	реле
jqx-141ff/024dnlnlnil	реле
jqx-141ff/024dsnlng	реле
jqx-141ff/024dsnlnil	реле
jqx-141ff/024dspg	реле
jqx-141ff/024dspnil	реле
jqx-141ff/024hnlng	реле
jqx-141ff/024hnlnilnil	реле
jqx-141ff/024hnlng	реле
jqx-141ff/024hnllnil	реле
jqx-141ff/024hsnlng	реле
jqx-141ff/024hsnlnil	реле
jqx-141ff/024hsng	реле
jqx-141ff/024hslnil	реле
jqx-141ff/024znlng	реле
jqx-141ff/024znlnilnil	реле
jqx-141ff/024znlpg	реле
jqx-141ff/024znllnil	реле
jqx-141ff/024zsnlng	реле
jqx-141ff/024zsnlnil	реле
jqx-141ff/024zspg	реле
jqx-141ff/024zspnil	реле
jqx-141ff/048dnlnlpg	реле
jqx-141ff/048dnlnlnil	реле
jqx-141ff/048dnlnlpg	реле
jqx-141ff/048dnlnlnil	реле
jqx-141ff/048dsnlng	реле

jqx-141ff/048dsnilnil	реле
jqx-141ff/048dspg	реле
jqx-141ff/048dspnil	реле
jqx-141ff/048hnilnilg	реле
jqx-141ff/048hnilnilnil	реле
jqx-141ff/048hnilpg	реле
jqx-141ff/048hnilpnil	реле
jqx-141ff/048hsnilg	реле
jqx-141ff/048hsnilnil	реле
jqx-141ff/048hspg	реле
jqx-141ff/048hsnilg	реле
jqx-141ff/048hsnilnil	реле
jqx-141ff/048hsnilpnil	реле
jqx-141ff/048znilnilg	реле
jqx-141ff/048znilnilnil	реле
jqx-141ff/048znilpg	реле
jqx-141ff/048znilpnil	реле
jqx-141ff/048zsnilg	реле
jqx-141ff/048zsnilnil	реле
jqx-141ff/048zspg	реле
jqx-141ff/048zspnil	реле
jqx-141ff1as10adc30.543.3	реле switching capacity from 10a 16
jqx-141ff1as10adc50.543.3	реле switching capacity from 10a 16
jqx-141ff1as10adc60.543.3	реле switching capacity from 10a 16
jqx-141ff1as10adc90.543.3	реле switching capacity from 10a 16
jqx-141ff1as16adc30.543.3	реле switching capacity from 10a 16
jqx-141ff1as16adc50.543.3	реле switching capacity from 10a 16
jqx-141ff1as16adc60.543.3	реле switching capacity from 10a 16
jqx-141ff1as16adc90.543.3	реле switching capacity from 10a 16
jqx-141ff1as5adc120.543.3	реле switching capacity from 10a 16

jqx-141ff1as5adc30.543.3	реле switching capacity from 10a 16
jqx-141ff1as5adc50.543.3	реле switching capacity from 10a 16
jqx-141ff1as5adc60.543.3	реле switching capacity from 10a 16
jqx-141ff1as5adc90.543.3	реле switching capacity from 10a 16
jqx-141ff1as8adc120.543.3	реле switching capacity from 10a 16
jqx-141ff1as8adc30.543.3	реле switching capacity from 10a 16
jqx-141ff1as8adc50.543.3	реле switching capacity from 10a 16
jqx-141ff1as8adc60.543.3	реле switching capacity from 10a 16
jqx-141ff1as8adc90.543.3	реле switching capacity from 10a 16
jqx-141ff1az10adc30.543.3	реле switching capacity from 10a 16
jqx-141ff1az10adc50.543.3	реле switching capacity from 10a 16
jqx-141ff1az10adc60.543.3	реле switching capacity from 10a 16
jqx-141ff1az10adc90.543.3	реле switching capacity from 10a 16
jqx-141ff1az16adc30.543.3	реле switching capacity from 10a 16
jqx-141ff1az16adc50.543.3	реле switching capacity from 10a 16
jqx-141ff1az16adc60.543.3	реле switching capacity from 10a 16
jqx-141ff1az16adc90.543.3	реле switching capacity from 10a 16
jqx-141ff1az5adc120.543.3	реле switching capacity from 10a 16
jqx-141ff1az5adc30.543.3	реле switching capacity from 10a 16
jqx-141ff1az5adc50.543.3	реле switching capacity from 10a 16
jqx-141ff1az5adc60.543.3	реле switching capacity from 10a 16
jqx-141ff1az5adc90.543.3	реле switching capacity from 10a 16
jqx-141ff1az8adc120.543.3	реле switching capacity from 10a 16
jqx-141ff1az8adc30.543.3	реле switching capacity from 10a 16
jqx-141ff1az8adc50.543.3	реле switching capacity from 10a 16
jqx-141ff1az8adc60.543.3	реле switching capacity from 10a 16
jqx-141ff1az8adc90.543.3	реле switching capacity from 10a 16
jqx-141ff1cs10adc30.543.3	реле switching capacity from 10a 16

jqx-141ff1cs10adc50.543.3	реле switching capacity from 10a 16
jqx-141ff1cs10adc60.543.3	реле switching capacity from 10a 16
jqx-141ff1cs10adc90.543.3	реле switching capacity from 10a 16
jqx-141ff1cs16adc30.543.3	реле switching capacity from 10a 16
jqx-141ff1cs16adc50.543.3	реле switching capacity from 10a 16
jqx-141ff1cs16adc60.543.3	реле switching capacity from 10a 16
jqx-141ff1cs16adc90.543.3	реле switching capacity from 10a 16
jqx-141ff1cs5adc120.543.3	реле switching capacity from 10a 16
jqx-141ff1cs5adc30.543.3	реле switching capacity from 10a 16
jqx-141ff1cs5adc50.543.3	реле switching capacity from 10a 16
jqx-141ff1cs5adc60.543.3	реле switching capacity from 10a 16
jqx-141ff1cs5adc90.543.3	реле switching capacity from 10a 16
jqx-141ff1cs8adc120.543.3	реле switching capacity from 10a 16
jqx-141ff1cs8adc30.543.3	реле switching capacity from 10a 16
jqx-141ff1cs8adc50.543.3	реле switching capacity from 10a 16
jqx-141ff1cs8adc60.543.3	реле switching capacity from 10a 16
jqx-141ff1cs8adc90.543.3	реле switching capacity from 10a 16
jqx-141ff1cz10adc30.543.3	реле switching capacity from 10a 16
jqx-141ff1cz10adc50.543.3	реле switching capacity from 10a 16
jqx-141ff1cz10adc60.543.3	реле switching capacity from 10a 16
jqx-141ff1cz10adc90.543.3	реле switching capacity from 10a 16
jqx-141ff1cz16adc30.543.3	реле switching capacity from 10a 16
jqx-141ff1cz16adc50.543.3	реле switching capacity from 10a 16
jqx-141ff1cz16adc60.543.3	реле switching capacity from 10a 16
jqx-141ff1cz16adc90.543.3	реле switching capacity from 10a 16
jqx-141ff1cz5adc120.543.3	реле switching capacity from 10a 16
jqx-141ff1cz5adc30.543.3	реле switching capacity from 10a 16
jqx-141ff1cz5adc50.543.3	реле switching capacity from 10a 16

jqx-141ff1cz5adc60.543.3	реле switching capacity from 10a 16
jqx-141ff1cz5adc90.543.3	реле switching capacity from 10a 16
jqx-141ff1cz8adc120.543.3	реле switching capacity from 10a 16
jqx-141ff1cz8adc30.543.3	реле switching capacity from 10a 16
jqx-141ff1cz8adc50.543.3	реле switching capacity from 10a 16
jqx-141ff1cz8adc60.543.3	реле switching capacity from 10a 16
jqx-141ff1cz8adc90.543.3	реле switching capacity from 10a 16
jqx-141ff2as10adc30.543.3	реле switching capacity from 10a 16
jqx-141ff2as10adc50.543.3	реле switching capacity from 10a 16
jqx-141ff2as10adc60.543.3	реле switching capacity from 10a 16
jqx-141ff2as10adc90.543.3	реле switching capacity from 10a 16
jqx-141ff2as16adc30.543.3	реле switching capacity from 10a 16
jqx-141ff2as16adc50.543.3	реле switching capacity from 10a 16
jqx-141ff2as16adc60.543.3	реле switching capacity from 10a 16
jqx-141ff2as16adc90.543.3	реле switching capacity from 10a 16
jqx-141ff2as5adc120.543.3	реле switching capacity from 10a 16
jqx-141ff2as5adc30.543.3	реле switching capacity from 10a 16
jqx-141ff2as5adc50.543.3	реле switching capacity from 10a 16
jqx-141ff2as5adc60.543.3	реле switching capacity from 10a 16
jqx-141ff2as5adc90.543.3	реле switching capacity from 10a 16
jqx-141ff2as8adc120.543.3	реле switching capacity from 10a 16
jqx-141ff2as8adc30.543.3	реле switching capacity from 10a 16
jqx-141ff2as8adc50.543.3	реле switching capacity from 10a 16
jqx-141ff2as8adc60.543.3	реле switching capacity from 10a 16
jqx-141ff2as8adc90.543.3	реле switching capacity from 10a 16
jqx-141ff2az10adc30.543.3	реле switching capacity from 10a 16
jqx-141ff2az10adc50.543.3	реле switching capacity from 10a 16
jqx-141ff2az10adc60.543.3	реле switching capacity from 10a 16

jqx-141ff2az10adc90.543.3	реле switching capacity from 10a 16
jqx-141ff2az16adc30.543.3	реле switching capacity from 10a 16
jqx-141ff2az16adc50.543.3	реле switching capacity from 10a 16
jqx-141ff2az16adc60.543.3	реле switching capacity from 10a 16
jqx-141ff2az16adc90.543.3	реле switching capacity from 10a 16
jqx-141ff2az5adc120.543.3	реле switching capacity from 10a 16
jqx-141ff2az5adc30.543.3	реле switching capacity from 10a 16
jqx-141ff2az5adc50.543.3	реле switching capacity from 10a 16
jqx-141ff2az5adc60.543.3	реле switching capacity from 10a 16
jqx-141ff2az5adc90.543.3	реле switching capacity from 10a 16
jqx-141ff2az8adc120.543.3	реле switching capacity from 10a 16
jqx-141ff2az8adc30.543.3	реле switching capacity from 10a 16
jqx-141ff2az8adc50.543.3	реле switching capacity from 10a 16
jqx-141ff2az8adc60.543.3	реле switching capacity from 10a 16
jqx-141ff2az8adc90.543.3	реле switching capacity from 10a 16
jqx-141ff2cs10adc30.543.3	реле switching capacity from 10a 16
jqx-141ff2cs10adc50.543.3	реле switching capacity from 10a 16
jqx-141ff2cs10adc60.543.3	реле switching capacity from 10a 16
jqx-141ff2cs10adc90.543.3	реле switching capacity from 10a 16
jqx-141ff2cs16adc30.543.3	реле switching capacity from 10a 16
jqx-141ff2cs16adc50.543.3	реле switching capacity from 10a 16
jqx-141ff2cs16adc60.543.3	реле switching capacity from 10a 16
jqx-141ff2cs16adc90.543.3	реле switching capacity from 10a 16
jqx-141ff2cs5adc120.543.3	реле switching capacity from 10a 16
jqx-141ff2cs5adc30.543.3	реле switching capacity from 10a 16
jqx-141ff2cs5adc50.543.3	реле switching capacity from 10a 16
jqx-141ff2cs5adc60.543.3	реле switching capacity from 10a 16
jqx-141ff2cs5adc90.543.3	реле switching capacity from 10a 16

jqx-141ff2cs8adc120.543.3 реле switching capacity from 10a 16
jqx-141ff2cs8adc30.543.3 реле switching capacity from 10a 16
jqx-141ff2cs8adc50.543.3 реле switching capacity from 10a 16
jqx-141ff2cs8adc60.543.3 реле switching capacity from 10a 16
jqx-141ff2cs8adc90.543.3 реле switching capacity from 10a 16
jqx-141ff2cz10adc30.543.3 реле switching capacity from 10a 16
jqx-141ff2cz10adc50.543.3 реле switching capacity from 10a 16
jqx-141ff2cz10adc60.543.3 реле switching capacity from 10a 16
jqx-141ff2cz10adc90.543.3 реле switching capacity from 10a 16
jqx-141ff2cz16adc30.543.3 реле switching capacity from 10a 16
jqx-141ff2cz16adc50.543.3 реле switching capacity from 10a 16
jqx-141ff2cz16adc60.543.3 реле switching capacity from 10a 16
jqx-141ff2cz16adc90.543.3 реле switching capacity from 10a 16
jqx-141ff2cz5adc120.543.3 реле switching capacity from 10a 16
jqx-141ff2cz5adc30.543.3 реле switching capacity from 10a 16
jqx-141ff2cz5adc50.543.3 реле switching capacity from 10a 16
jqx-141ff2cz5adc60.543.3 реле switching capacity from 10a 16
jqx-141ff2cz5adc90.543.3 реле switching capacity from 10a 16
jqx-141ff2cz8adc120.543.3 реле switching capacity from 10a 16
jqx-141ff2cz8adc30.543.3 реле switching capacity from 10a 16
jqx-141ff2cz8adc50.543.3 реле switching capacity from 10a 16
jqx-141ff2cz8adc60.543.3 реле switching capacity from 10a 16
jqx-141ff2cz8adc90.543.3 реле switching capacity from 10a 16

jqx-14f-w012-z glenair

jqx-14fc реле

jqx-14fc-2c-12v группа: реле, описание: тип контактов: 2c; катушки: 12в; , габариты: 29x12,8x26мм

jqx-14fc-2c-24v группа: реле, описание: тип контактов: 2c; катушки: 24в; , габариты: 29x12,8x26мм

jqx-14fc1 ningbo forward relay corporation

jqx-14fc12as10 реле
jqx-14fc12as16 реле
jqx-14fc12as20 реле
jqx-14fc12as3 реле
jqx-14fc12as5 реле
jqx-14fc12as6 реле
jqx-14fc12as8 реле
jqx-14fc12az10 реле
jqx-14fc12az16 реле
jqx-14fc12az20 реле
jqx-14fc12az3 реле
jqx-14fc12az5 реле
jqx-14fc12az6 реле
jqx-14fc12az8 реле
jqx-14fc12cs10 реле
jqx-14fc12cs16 реле
jqx-14fc12cs20 реле
jqx-14fc12cs3 реле
jqx-14fc12cs5 реле
jqx-14fc12cs6 реле
jqx-14fc12cs8 реле
jqx-14fc12cz10 реле
jqx-14fc12cz16 реле
jqx-14fc12cz20 реле
jqx-14fc12cz3 реле
jqx-14fc12cz5 реле
jqx-14fc12cz6 реле
jqx-14fc12cz8 реле

jqx-14fc1as10 реле
jqx-14fc1as16 реле
jqx-14fc1as20 реле
jqx-14fc1as3 реле
jqx-14fc1as5 реле
jqx-14fc1as6 реле
jqx-14fc1as8 реле
jqx-14fc1az10 реле
jqx-14fc1az16 реле
jqx-14fc1az20 реле
jqx-14fc1az3 реле
jqx-14fc1az5 реле
jqx-14fc1az6 реле
jqx-14fc1az8 реле
jqx-14fc1cs10 реле
jqx-14fc1cs16 реле
jqx-14fc1cs16dc12v5.0 ningbo forward relay corporation ltd
jqx-14fc1cs20 реле
jqx-14fc1cs3 реле
jqx-14fc1cs5 реле
jqx-14fc1cs6 реле
jqx-14fc1cs8 реле
jqx-14fc1cz10 реле
jqx-14fc1cz16 реле
jqx-14fc1cz20 реле
jqx-14fc1cz3 реле
jqx-14fc1cz5 реле
jqx-14fc1cz6 реле

jqx-14fc1cz8 реле
jqx-14fc2 ningbo forward relay corporation
jqx-14fc22as10 реле
jqx-14fc22as16 реле
jqx-14fc22as20 реле
jqx-14fc22as3 реле
jqx-14fc22as5 реле
jqx-14fc22as6 реле
jqx-14fc22as8 реле
jqx-14fc22az10 реле
jqx-14fc22az16 реле
jqx-14fc22az20 реле
jqx-14fc22az3 реле
jqx-14fc22az5 реле
jqx-14fc22az6 реле
jqx-14fc22az8 реле
jqx-14fc22cs10 реле
jqx-14fc22cs16 реле
jqx-14fc22cs20 реле
jqx-14fc22cs3 реле
jqx-14fc22cs5 реле
jqx-14fc22cs6 реле
jqx-14fc22cs8 реле
jqx-14fc22cz10 реле
jqx-14fc22cz16 реле
jqx-14fc22cz20 реле
jqx-14fc22cz3 реле
jqx-14fc22cz5 реле

jqx-14fc22cz6 реле
jqx-14fc22cz8 реле
jqx-14fc2as10 реле
jqx-14fc2as10aac120.83.5 реле
jqx-14fc2as10aac120.85 реле
jqx-14fc2as10aac121.23.5 реле
jqx-14fc2as10aac121.25 реле
jqx-14fc2as10aac1213.5 реле
jqx-14fc2as10aac1215 реле
jqx-14fc2as10aac12nil3.5 реле
jqx-14fc2as10aac12nil5 реле
jqx-14fc2as10aac240.83.5 реле
jqx-14fc2as10aac240.85 реле
jqx-14fc2as10aac241.23.5 реле
jqx-14fc2as10aac241.25 реле
jqx-14fc2as10aac2413.5 реле
jqx-14fc2as10aac2415 реле
jqx-14fc2as10aac24nil3.5 реле
jqx-14fc2as10aac24nil5 реле
jqx-14fc2as10aac60.83.5 реле
jqx-14fc2as10aac60.85 реле
jqx-14fc2as10aac61.23.5 реле
jqx-14fc2as10aac61.25 реле
jqx-14fc2as10aac613.5 реле
jqx-14fc2as10aac615 реле
jqx-14fc2as10aac6nil3.5 реле
jqx-14fc2as10aac6nil5 реле
jqx-14fc2as10adc120.83.5 реле

jqx-14fc2as10adc120.85	реле
jqx-14fc2as10adc121.23.5	реле
jqx-14fc2as10adc121.25	реле
jqx-14fc2as10adc1213.5	реле
jqx-14fc2as10adc1215	реле
jqx-14fc2as10adc12nil3.5	реле
jqx-14fc2as10adc12nil5	реле
jqx-14fc2as10adc240.83.5	реле
jqx-14fc2as10adc240.85	реле
jqx-14fc2as10adc241.23.5	реле
jqx-14fc2as10adc241.25	реле
jqx-14fc2as10adc2413.5	реле
jqx-14fc2as10adc2415	реле
jqx-14fc2as10adc24nil3.5	реле
jqx-14fc2as10adc24nil5	реле
jqx-14fc2as10adc60.83.5	реле
jqx-14fc2as10adc60.85	реле
jqx-14fc2as10adc61.23.5	реле
jqx-14fc2as10adc61.25	реле
jqx-14fc2as10adc613.5	реле
jqx-14fc2as10adc615	реле
jqx-14fc2as10adc6nil3.5	реле
jqx-14fc2as10adc6nil5	реле
jqx-14fc2as16	реле
jqx-14fc2as20	реле
jqx-14fc2as20aac120.83.5	реле
jqx-14fc2as20aac120.85	реле
jqx-14fc2as20aac121.23.5	реле

jqx-14fc2as20aac121.25	реле
jqx-14fc2as20aac1213.5	реле
jqx-14fc2as20aac1215	реле
jqx-14fc2as20aac12nil3.5	реле
jqx-14fc2as20aac12nil5	реле
jqx-14fc2as20aac240.83.5	реле
jqx-14fc2as20aac240.85	реле
jqx-14fc2as20aac241.23.5	реле
jqx-14fc2as20aac241.25	реле
jqx-14fc2as20aac2413.5	реле
jqx-14fc2as20aac2415	реле
jqx-14fc2as20aac24nil3.5	реле
jqx-14fc2as20aac24nil5	реле
jqx-14fc2as20aac60.83.5	реле
jqx-14fc2as20aac60.85	реле
jqx-14fc2as20aac61.23.5	реле
jqx-14fc2as20aac61.25	реле
jqx-14fc2as20aac613.5	реле
jqx-14fc2as20aac615	реле
jqx-14fc2as20aac6nil3.5	реле
jqx-14fc2as20aac6nil5	реле
jqx-14fc2as20adc120.83.5	реле
jqx-14fc2as20adc120.85	реле
jqx-14fc2as20adc121.23.5	реле
jqx-14fc2as20adc121.25	реле
jqx-14fc2as20adc1213.5	реле
jqx-14fc2as20adc1215	реле
jqx-14fc2as20adc12nil3.5	реле

jqx-14fc2as20adc12nil5 реле
jqx-14fc2as20adc240.83.5 реле
jqx-14fc2as20adc240.85 реле
jqx-14fc2as20adc241.23.5 реле
jqx-14fc2as20adc241.25 реле
jqx-14fc2as20adc2413.5 реле
jqx-14fc2as20adc2415 реле
jqx-14fc2as20adc24nil3.5 реле
jqx-14fc2as20adc24nil5 реле
jqx-14fc2as20adc60.83.5 реле
jqx-14fc2as20adc60.85 реле
jqx-14fc2as20adc61.23.5 реле
jqx-14fc2as20adc61.25 реле
jqx-14fc2as20adc613.5 реле
jqx-14fc2as20adc615 реле
jqx-14fc2as20adc6nil3.5 реле
jqx-14fc2as20adc6nil5 реле
jqx-14fc2as3 реле
jqx-14fc2as3aac120.83.5 реле
jqx-14fc2as3aac120.85 реле
jqx-14fc2as3aac121.23.5 реле
jqx-14fc2as3aac121.25 реле
jqx-14fc2as3aac1213.5 реле
jqx-14fc2as3aac1215 реле
jqx-14fc2as3aac12nil3.5 реле
jqx-14fc2as3aac12nil5 реле
jqx-14fc2as3aac240.83.5 реле
jqx-14fc2as3aac240.85 реле

jqx-14fc2as3aac241.23.5 реле
jqx-14fc2as3aac241.25 реле
jqx-14fc2as3aac2413.5 реле
jqx-14fc2as3aac2415 реле
jqx-14fc2as3aac24nil3.5 реле
jqx-14fc2as3aac24nil5 реле
jqx-14fc2as3aac60.83.5 реле
jqx-14fc2as3aac60.85 реле
jqx-14fc2as3aac61.23.5 реле
jqx-14fc2as3aac61.25 реле
jqx-14fc2as3aac613.5 реле
jqx-14fc2as3aac615 реле
jqx-14fc2as3aac6nil3.5 реле
jqx-14fc2as3aac6nil5 реле
jqx-14fc2as3adc120.83.5 реле
jqx-14fc2as3adc120.85 реле
jqx-14fc2as3adc121.23.5 реле
jqx-14fc2as3adc121.25 реле
jqx-14fc2as3adc1213.5 реле
jqx-14fc2as3adc1215 реле
jqx-14fc2as3adc12nil3.5 реле
jqx-14fc2as3adc12nil5 реле
jqx-14fc2as3adc240.83.5 реле
jqx-14fc2as3adc240.85 реле
jqx-14fc2as3adc241.23.5 реле
jqx-14fc2as3adc241.25 реле
jqx-14fc2as3adc2413.5 реле
jqx-14fc2as3adc2415 реле

jqx-14fc2as3adc24nil3.5 реле
jqx-14fc2as3adc24nil5 реле
jqx-14fc2as3adc60.83.5 реле
jqx-14fc2as3adc60.85 реле
jqx-14fc2as3adc61.23.5 реле
jqx-14fc2as3adc61.25 реле
jqx-14fc2as3adc613.5 реле
jqx-14fc2as3adc615 реле
jqx-14fc2as3adc6nil3.5 реле
jqx-14fc2as3adc6nil5 реле
jqx-14fc2as5 реле
jqx-14fc2as5aac120.83.5 реле
jqx-14fc2as5aac120.85 реле
jqx-14fc2as5aac121.23.5 реле
jqx-14fc2as5aac121.25 реле
jqx-14fc2as5aac1213.5 реле
jqx-14fc2as5aac1215 реле
jqx-14fc2as5aac12nil3.5 реле
jqx-14fc2as5aac12nil5 реле
jqx-14fc2as5aac240.83.5 реле
jqx-14fc2as5aac240.85 реле
jqx-14fc2as5aac241.23.5 реле
jqx-14fc2as5aac241.25 реле
jqx-14fc2as5aac2413.5 реле
jqx-14fc2as5aac2415 реле
jqx-14fc2as5aac24nil3.5 реле
jqx-14fc2as5aac24nil5 реле
jqx-14fc2as5aac60.83.5 реле

jqx-14fc2as5aac60.85 реле
jqx-14fc2as5aac61.23.5 реле
jqx-14fc2as5aac61.25 реле
jqx-14fc2as5aac613.5 реле
jqx-14fc2as5aac615 реле
jqx-14fc2as5aac6nil3.5 реле
jqx-14fc2as5aac6nil5 реле
jqx-14fc2as5adc120.83.5 реле
jqx-14fc2as5adc120.85 реле
jqx-14fc2as5adc121.23.5 реле
jqx-14fc2as5adc121.25 реле
jqx-14fc2as5adc1213.5 реле
jqx-14fc2as5adc1215 реле
jqx-14fc2as5adc12nil3.5 реле
jqx-14fc2as5adc12nil5 реле
jqx-14fc2as5adc240.83.5 реле
jqx-14fc2as5adc240.85 реле
jqx-14fc2as5adc241.23.5 реле
jqx-14fc2as5adc241.25 реле
jqx-14fc2as5adc2413.5 реле
jqx-14fc2as5adc2415 реле
jqx-14fc2as5adc24nil3.5 реле
jqx-14fc2as5adc24nil5 реле
jqx-14fc2as5adc60.83.5 реле
jqx-14fc2as5adc60.85 реле
jqx-14fc2as5adc61.23.5 реле
jqx-14fc2as5adc61.25 реле
jqx-14fc2as5adc613.5 реле

jqx-14fc2as5adc615 реле
jqx-14fc2as5adc6nil3.5 реле
jqx-14fc2as5adc6nil5 реле
jqx-14fc2as6 реле
jqx-14fc2as6aac120.83.5 реле
jqx-14fc2as6aac120.85 реле
jqx-14fc2as6aac121.23.5 реле
jqx-14fc2as6aac121.25 реле
jqx-14fc2as6aac1213.5 реле
jqx-14fc2as6aac1215 реле
jqx-14fc2as6aac12nil3.5 реле
jqx-14fc2as6aac12nil5 реле
jqx-14fc2as6aac240.83.5 реле
jqx-14fc2as6aac240.85 реле
jqx-14fc2as6aac241.23.5 реле
jqx-14fc2as6aac241.25 реле
jqx-14fc2as6aac2413.5 реле
jqx-14fc2as6aac2415 реле
jqx-14fc2as6aac24nil3.5 реле
jqx-14fc2as6aac24nil5 реле
jqx-14fc2as6aac60.83.5 реле
jqx-14fc2as6aac60.85 реле
jqx-14fc2as6aac61.23.5 реле
jqx-14fc2as6aac61.25 реле
jqx-14fc2as6aac613.5 реле
jqx-14fc2as6aac615 реле
jqx-14fc2as6aac6nil3.5 реле
jqx-14fc2as6aac6nil5 реле

jqx-14fc2as6adc120.83.5 реле
jqx-14fc2as6adc120.85 реле
jqx-14fc2as6adc121.23.5 реле
jqx-14fc2as6adc121.25 реле
jqx-14fc2as6adc1213.5 реле
jqx-14fc2as6adc1215 реле
jqx-14fc2as6adc12nil3.5 реле
jqx-14fc2as6adc12nil5 реле
jqx-14fc2as6adc240.83.5 реле
jqx-14fc2as6adc240.85 реле
jqx-14fc2as6adc241.23.5 реле
jqx-14fc2as6adc241.25 реле
jqx-14fc2as6adc2413.5 реле
jqx-14fc2as6adc2415 реле
jqx-14fc2as6adc24nil3.5 реле
jqx-14fc2as6adc24nil5 реле
jqx-14fc2as6adc60.83.5 реле
jqx-14fc2as6adc60.85 реле
jqx-14fc2as6adc61.23.5 реле
jqx-14fc2as6adc61.25 реле
jqx-14fc2as6adc613.5 реле
jqx-14fc2as6adc615 реле
jqx-14fc2as6adc6nil3.5 реле
jqx-14fc2as6adc6nil5 реле
jqx-14fc2as8 реле
jqx-14fc2az10 реле
jqx-14fc2az10aac120.83.5 реле
jqx-14fc2az10aac120.85 реле

jqx-14fc2az10aac121.23.5	реле
jqx-14fc2az10aac121.25	реле
jqx-14fc2az10aac1213.5	реле
jqx-14fc2az10aac1215	реле
jqx-14fc2az10aac12nil3.5	реле
jqx-14fc2az10aac12nil5	реле
jqx-14fc2az10aac240.83.5	реле
jqx-14fc2az10aac240.85	реле
jqx-14fc2az10aac241.23.5	реле
jqx-14fc2az10aac241.25	реле
jqx-14fc2az10aac2413.5	реле
jqx-14fc2az10aac2415	реле
jqx-14fc2az10aac24nil3.5	реле
jqx-14fc2az10aac24nil5	реле
jqx-14fc2az10aac60.83.5	реле
jqx-14fc2az10aac60.85	реле
jqx-14fc2az10aac61.23.5	реле
jqx-14fc2az10aac61.25	реле
jqx-14fc2az10aac613.5	реле
jqx-14fc2az10aac615	реле
jqx-14fc2az10aac6nil3.5	реле
jqx-14fc2az10aac6nil5	реле
jqx-14fc2az10adc120.83.5	реле
jqx-14fc2az10adc120.85	реле
jqx-14fc2az10adc121.23.5	реле
jqx-14fc2az10adc121.25	реле
jqx-14fc2az10adc1213.5	реле
jqx-14fc2az10adc1215	реле

jqx-14fc2az10adc12nil3.5 реле
jqx-14fc2az10adc12nil5 реле
jqx-14fc2az10adc240.83.5 реле
jqx-14fc2az10adc240.85 реле
jqx-14fc2az10adc241.23.5 реле
jqx-14fc2az10adc241.25 реле
jqx-14fc2az10adc2413.5 реле
jqx-14fc2az10adc2415 реле
jqx-14fc2az10adc24nil3.5 реле
jqx-14fc2az10adc24nil5 реле
jqx-14fc2az10adc60.83.5 реле
jqx-14fc2az10adc60.85 реле
jqx-14fc2az10adc61.23.5 реле
jqx-14fc2az10adc61.25 реле
jqx-14fc2az10adc613.5 реле
jqx-14fc2az10adc615 реле
jqx-14fc2az10adc6nil3.5 реле
jqx-14fc2az10adc6nil5 реле
jqx-14fc2az16 реле
jqx-14fc2az20 реле
jqx-14fc2az20aac120.83.5 реле
jqx-14fc2az20aac120.85 реле
jqx-14fc2az20aac121.23.5 реле
jqx-14fc2az20aac121.25 реле
jqx-14fc2az20aac1213.5 реле
jqx-14fc2az20aac1215 реле
jqx-14fc2az20aac12nil3.5 реле
jqx-14fc2az20aac12nil5 реле

jqx-14fc2az20aac240.83.5	реле
jqx-14fc2az20aac240.85	реле
jqx-14fc2az20aac241.23.5	реле
jqx-14fc2az20aac241.25	реле
jqx-14fc2az20aac2413.5	реле
jqx-14fc2az20aac2415	реле
jqx-14fc2az20aac24nil3.5	реле
jqx-14fc2az20aac24nil5	реле
jqx-14fc2az20aac60.83.5	реле
jqx-14fc2az20aac60.85	реле
jqx-14fc2az20aac61.23.5	реле
jqx-14fc2az20aac61.25	реле
jqx-14fc2az20aac613.5	реле
jqx-14fc2az20aac615	реле
jqx-14fc2az20aac6nil3.5	реле
jqx-14fc2az20aac6nil5	реле
jqx-14fc2az20adc120.83.5	реле
jqx-14fc2az20adc120.85	реле
jqx-14fc2az20adc121.23.5	реле
jqx-14fc2az20adc121.25	реле
jqx-14fc2az20adc1213.5	реле
jqx-14fc2az20adc1215	реле
jqx-14fc2az20adc12nil3.5	реле
jqx-14fc2az20adc12nil5	реле
jqx-14fc2az20adc240.83.5	реле
jqx-14fc2az20adc240.85	реле
jqx-14fc2az20adc241.23.5	реле
jqx-14fc2az20adc241.25	реле

jqx-14fc2az20adc2413.5	реле
jqx-14fc2az20adc2415	реле
jqx-14fc2az20adc24nil3.5	реле
jqx-14fc2az20adc24nil5	реле
jqx-14fc2az20adc60.83.5	реле
jqx-14fc2az20adc60.85	реле
jqx-14fc2az20adc61.23.5	реле
jqx-14fc2az20adc61.25	реле
jqx-14fc2az20adc613.5	реле
jqx-14fc2az20adc615	реле
jqx-14fc2az20adc6nil3.5	реле
jqx-14fc2az20adc6nil5	реле
jqx-14fc2az3	реле
jqx-14fc2az3aac120.83.5	реле
jqx-14fc2az3aac120.85	реле
jqx-14fc2az3aac121.23.5	реле
jqx-14fc2az3aac121.25	реле
jqx-14fc2az3aac1213.5	реле
jqx-14fc2az3aac1215	реле
jqx-14fc2az3aac12nil3.5	реле
jqx-14fc2az3aac12nil5	реле
jqx-14fc2az3aac240.83.5	реле
jqx-14fc2az3aac240.85	реле
jqx-14fc2az3aac241.23.5	реле
jqx-14fc2az3aac241.25	реле
jqx-14fc2az3aac2413.5	реле
jqx-14fc2az3aac2415	реле
jqx-14fc2az3aac24nil3.5	реле

jqx-14fc2az3aac24nil5 реле
jqx-14fc2az3aac60.83.5 реле
jqx-14fc2az3aac60.85 реле
jqx-14fc2az3aac61.23.5 реле
jqx-14fc2az3aac61.25 реле
jqx-14fc2az3aac613.5 реле
jqx-14fc2az3aac615 реле
jqx-14fc2az3aac6nil3.5 реле
jqx-14fc2az3aac6nil5 реле
jqx-14fc2az3adc120.83.5 реле
jqx-14fc2az3adc120.85 реле
jqx-14fc2az3adc121.23.5 реле
jqx-14fc2az3adc121.25 реле
jqx-14fc2az3adc1213.5 реле
jqx-14fc2az3adc1215 реле
jqx-14fc2az3adc12nil3.5 реле
jqx-14fc2az3adc12nil5 реле
jqx-14fc2az3adc240.83.5 реле
jqx-14fc2az3adc240.85 реле
jqx-14fc2az3adc241.23.5 реле
jqx-14fc2az3adc241.25 реле
jqx-14fc2az3adc2413.5 реле
jqx-14fc2az3adc2415 реле
jqx-14fc2az3adc24nil3.5 реле
jqx-14fc2az3adc24nil5 реле
jqx-14fc2az3adc60.83.5 реле
jqx-14fc2az3adc60.85 реле
jqx-14fc2az3adc61.23.5 реле

jqx-14fc2az3adc61.25 реле
jqx-14fc2az3adc613.5 реле
jqx-14fc2az3adc615 реле
jqx-14fc2az3adc6nil3.5 реле
jqx-14fc2az3adc6nil5 реле
jqx-14fc2az5 реле
jqx-14fc2az5aac120.83.5 реле
jqx-14fc2az5aac120.85 реле
jqx-14fc2az5aac121.23.5 реле
jqx-14fc2az5aac121.25 реле
jqx-14fc2az5aac1213.5 реле
jqx-14fc2az5aac1215 реле
jqx-14fc2az5aac12nil3.5 реле
jqx-14fc2az5aac12nil5 реле
jqx-14fc2az5aac240.83.5 реле
jqx-14fc2az5aac240.85 реле
jqx-14fc2az5aac241.23.5 реле
jqx-14fc2az5aac241.25 реле
jqx-14fc2az5aac2413.5 реле
jqx-14fc2az5aac2415 реле
jqx-14fc2az5aac24nil3.5 реле
jqx-14fc2az5aac24nil5 реле
jqx-14fc2az5aac60.83.5 реле
jqx-14fc2az5aac60.85 реле
jqx-14fc2az5aac61.23.5 реле
jqx-14fc2az5aac61.25 реле
jqx-14fc2az5aac613.5 реле
jqx-14fc2az5aac615 реле

jqx-14fc2az5aac6nil3.5 реле
jqx-14fc2az5aac6nil5 реле
jqx-14fc2az5adc120.83.5 реле
jqx-14fc2az5adc120.85 реле
jqx-14fc2az5adc121.23.5 реле
jqx-14fc2az5adc121.25 реле
jqx-14fc2az5adc1213.5 реле
jqx-14fc2az5adc1215 реле
jqx-14fc2az5adc12nil3.5 реле
jqx-14fc2az5adc12nil5 реле
jqx-14fc2az5adc240.83.5 реле
jqx-14fc2az5adc240.85 реле
jqx-14fc2az5adc241.23.5 реле
jqx-14fc2az5adc241.25 реле
jqx-14fc2az5adc2413.5 реле
jqx-14fc2az5adc2415 реле
jqx-14fc2az5adc24nil3.5 реле
jqx-14fc2az5adc24nil5 реле
jqx-14fc2az5adc60.83.5 реле
jqx-14fc2az5adc60.85 реле
jqx-14fc2az5adc61.23.5 реле
jqx-14fc2az5adc61.25 реле
jqx-14fc2az5adc613.5 реле
jqx-14fc2az5adc615 реле
jqx-14fc2az5adc6nil3.5 реле
jqx-14fc2az5adc6nil5 реле
jqx-14fc2az6 реле
jqx-14fc2az6aac120.83.5 реле

jqx-14fc2az6aac120.85 реле
jqx-14fc2az6aac121.23.5 реле
jqx-14fc2az6aac121.25 реле
jqx-14fc2az6aac1213.5 реле
jqx-14fc2az6aac1215 реле
jqx-14fc2az6aac12nil3.5 реле
jqx-14fc2az6aac12nil5 реле
jqx-14fc2az6aac240.83.5 реле
jqx-14fc2az6aac240.85 реле
jqx-14fc2az6aac241.23.5 реле
jqx-14fc2az6aac241.25 реле
jqx-14fc2az6aac2413.5 реле
jqx-14fc2az6aac2415 реле
jqx-14fc2az6aac24nil3.5 реле
jqx-14fc2az6aac24nil5 реле
jqx-14fc2az6aac60.83.5 реле
jqx-14fc2az6aac60.85 реле
jqx-14fc2az6aac61.23.5 реле
jqx-14fc2az6aac61.25 реле
jqx-14fc2az6aac613.5 реле
jqx-14fc2az6aac615 реле
jqx-14fc2az6aac6nil3.5 реле
jqx-14fc2az6aac6nil5 реле
jqx-14fc2az6adc120.83.5 реле
jqx-14fc2az6adc120.85 реле
jqx-14fc2az6adc121.23.5 реле
jqx-14fc2az6adc121.25 реле
jqx-14fc2az6adc1213.5 реле

jqx-14fc2az6adc1215 реле
jqx-14fc2az6adc12nil3.5 реле
jqx-14fc2az6adc12nil5 реле
jqx-14fc2az6adc240.83.5 реле
jqx-14fc2az6adc240.85 реле
jqx-14fc2az6adc241.23.5 реле
jqx-14fc2az6adc241.25 реле
jqx-14fc2az6adc2413.5 реле
jqx-14fc2az6adc2415 реле
jqx-14fc2az6adc24nil3.5 реле
jqx-14fc2az6adc24nil5 реле
jqx-14fc2az6adc60.83.5 реле
jqx-14fc2az6adc60.85 реле
jqx-14fc2az6adc61.23.5 реле
jqx-14fc2az6adc61.25 реле
jqx-14fc2az6adc613.5 реле
jqx-14fc2az6adc615 реле
jqx-14fc2az6adc6nil3.5 реле
jqx-14fc2az6adc6nil5 реле
jqx-14fc2az8 реле
jqx-14fc2cs10 реле
jqx-14fc2cs10aac120.83.5 реле
jqx-14fc2cs10aac120.85 реле
jqx-14fc2cs10aac121.23.5 реле
jqx-14fc2cs10aac121.25 реле
jqx-14fc2cs10aac1213.5 реле
jqx-14fc2cs10aac1215 реле
jqx-14fc2cs10aac12nil3.5 реле

jqx-14fc2cs10aac12nil5 реле
jqx-14fc2cs10aac240.83.5 реле
jqx-14fc2cs10aac240.85 реле
jqx-14fc2cs10aac241.23.5 реле
jqx-14fc2cs10aac241.25 реле
jqx-14fc2cs10aac2413.5 реле
jqx-14fc2cs10aac2415 реле
jqx-14fc2cs10aac24nil3.5 реле
jqx-14fc2cs10aac24nil5 реле
jqx-14fc2cs10aac60.83.5 реле
jqx-14fc2cs10aac60.85 реле
jqx-14fc2cs10aac61.23.5 реле
jqx-14fc2cs10aac61.25 реле
jqx-14fc2cs10aac613.5 реле
jqx-14fc2cs10aac615 реле
jqx-14fc2cs10aac6nil3.5 реле
jqx-14fc2cs10aac6nil5 реле
jqx-14fc2cs10adc120.83.5 реле
jqx-14fc2cs10adc120.85 реле
jqx-14fc2cs10adc121.23.5 реле
jqx-14fc2cs10adc121.25 реле
jqx-14fc2cs10adc1213.5 реле
jqx-14fc2cs10adc1215 реле
jqx-14fc2cs10adc12nil3.5 реле
jqx-14fc2cs10adc12nil5 реле
jqx-14fc2cs10adc240.83.5 реле
jqx-14fc2cs10adc240.85 реле
jqx-14fc2cs10adc241.23.5 реле

jqx-14fc2cs10adc241.25	реле
jqx-14fc2cs10adc2413.5	реле
jqx-14fc2cs10adc2415	реле
jqx-14fc2cs10adc24nil3.5	реле
jqx-14fc2cs10adc24nil5	реле
jqx-14fc2cs10adc60.83.5	реле
jqx-14fc2cs10adc60.85	реле
jqx-14fc2cs10adc61.23.5	реле
jqx-14fc2cs10adc61.25	реле
jqx-14fc2cs10adc613.5	реле
jqx-14fc2cs10adc615	реле
jqx-14fc2cs10adc6nil3.5	реле
jqx-14fc2cs10adc6nil5	реле
jqx-14fc2cs16	реле
jqx-14fc2cs20	реле
jqx-14fc2cs20aac120.83.5	реле
jqx-14fc2cs20aac120.85	реле
jqx-14fc2cs20aac121.23.5	реле
jqx-14fc2cs20aac121.25	реле
jqx-14fc2cs20aac1213.5	реле
jqx-14fc2cs20aac1215	реле
jqx-14fc2cs20aac12nil3.5	реле
jqx-14fc2cs20aac12nil5	реле
jqx-14fc2cs20aac240.83.5	реле
jqx-14fc2cs20aac240.85	реле
jqx-14fc2cs20aac241.23.5	реле
jqx-14fc2cs20aac241.25	реле
jqx-14fc2cs20aac2413.5	реле

jqx-14fc2cs20aac2415 реле
jqx-14fc2cs20aac24nil3.5 реле
jqx-14fc2cs20aac24nil5 реле
jqx-14fc2cs20aac60.83.5 реле
jqx-14fc2cs20aac60.85 реле
jqx-14fc2cs20aac61.23.5 реле
jqx-14fc2cs20aac61.25 реле
jqx-14fc2cs20aac613.5 реле
jqx-14fc2cs20aac615 реле
jqx-14fc2cs20aac6nil3.5 реле
jqx-14fc2cs20aac6nil5 реле
jqx-14fc2cs20adc120.83.5 реле
jqx-14fc2cs20adc120.85 реле
jqx-14fc2cs20adc121.23.5 реле
jqx-14fc2cs20adc121.25 реле
jqx-14fc2cs20adc1213.5 реле
jqx-14fc2cs20adc1215 реле
jqx-14fc2cs20adc12nil3.5 реле
jqx-14fc2cs20adc12nil5 реле
jqx-14fc2cs20adc240.83.5 реле
jqx-14fc2cs20adc240.85 реле
jqx-14fc2cs20adc241.23.5 реле
jqx-14fc2cs20adc241.25 реле
jqx-14fc2cs20adc2413.5 реле
jqx-14fc2cs20adc2415 реле
jqx-14fc2cs20adc24nil3.5 реле
jqx-14fc2cs20adc24nil5 реле
jqx-14fc2cs20adc60.83.5 реле

jqx-14fc2cs20adc60.85 реле
jqx-14fc2cs20adc61.23.5 реле
jqx-14fc2cs20adc61.25 реле
jqx-14fc2cs20adc613.5 реле
jqx-14fc2cs20adc615 реле
jqx-14fc2cs20adc6nil3.5 реле
jqx-14fc2cs20adc6nil5 реле
jqx-14fc2cs3 реле
jqx-14fc2cs3aac120.83.5 реле
jqx-14fc2cs3aac120.85 реле
jqx-14fc2cs3aac121.23.5 реле
jqx-14fc2cs3aac121.25 реле
jqx-14fc2cs3aac1213.5 реле
jqx-14fc2cs3aac1215 реле
jqx-14fc2cs3aac12nil3.5 реле
jqx-14fc2cs3aac12nil5 реле
jqx-14fc2cs3aac240.83.5 реле
jqx-14fc2cs3aac240.85 реле
jqx-14fc2cs3aac241.23.5 реле
jqx-14fc2cs3aac241.25 реле
jqx-14fc2cs3aac2413.5 реле
jqx-14fc2cs3aac2415 реле
jqx-14fc2cs3aac24nil3.5 реле
jqx-14fc2cs3aac24nil5 реле
jqx-14fc2cs3aac60.83.5 реле
jqx-14fc2cs3aac60.85 реле
jqx-14fc2cs3aac61.23.5 реле
jqx-14fc2cs3aac61.25 реле

jqx-14fc2cs3aac613.5 реле
jqx-14fc2cs3aac615 реле
jqx-14fc2cs3aac6nil3.5 реле
jqx-14fc2cs3aac6nil5 реле
jqx-14fc2cs3adc120.83.5 реле
jqx-14fc2cs3adc120.85 реле
jqx-14fc2cs3adc121.23.5 реле
jqx-14fc2cs3adc121.25 реле
jqx-14fc2cs3adc1213.5 реле
jqx-14fc2cs3adc1215 реле
jqx-14fc2cs3adc12nil3.5 реле
jqx-14fc2cs3adc12nil5 реле
jqx-14fc2cs3adc240.83.5 реле
jqx-14fc2cs3adc240.85 реле
jqx-14fc2cs3adc241.23.5 реле
jqx-14fc2cs3adc241.25 реле
jqx-14fc2cs3adc2413.5 реле
jqx-14fc2cs3adc2415 реле
jqx-14fc2cs3adc24nil3.5 реле
jqx-14fc2cs3adc24nil5 реле
jqx-14fc2cs3adc60.83.5 реле
jqx-14fc2cs3adc60.85 реле
jqx-14fc2cs3adc61.23.5 реле
jqx-14fc2cs3adc61.25 реле
jqx-14fc2cs3adc613.5 реле
jqx-14fc2cs3adc615 реле
jqx-14fc2cs3adc6nil3.5 реле
jqx-14fc2cs3adc6nil5 реле

jqx-14fc2cs5 реле
jqx-14fc2cs5aac120.83.5 реле
jqx-14fc2cs5aac120.85 реле
jqx-14fc2cs5aac121.23.5 реле
jqx-14fc2cs5aac121.25 реле
jqx-14fc2cs5aac1213.5 реле
jqx-14fc2cs5aac1215 реле
jqx-14fc2cs5aac12nil3.5 реле
jqx-14fc2cs5aac12nil5 реле
jqx-14fc2cs5aac240.83.5 реле
jqx-14fc2cs5aac240.85 реле
jqx-14fc2cs5aac241.23.5 реле
jqx-14fc2cs5aac241.25 реле
jqx-14fc2cs5aac2413.5 реле
jqx-14fc2cs5aac2415 реле
jqx-14fc2cs5aac24nil3.5 реле
jqx-14fc2cs5aac24nil5 реле
jqx-14fc2cs5aac60.83.5 реле
jqx-14fc2cs5aac60.85 реле
jqx-14fc2cs5aac61.23.5 реле
jqx-14fc2cs5aac61.25 реле
jqx-14fc2cs5aac613.5 реле
jqx-14fc2cs5aac615 реле
jqx-14fc2cs5aac6nil3.5 реле
jqx-14fc2cs5aac6nil5 реле
jqx-14fc2cs5adc120.83.5 реле
jqx-14fc2cs5adc120.85 реле
jqx-14fc2cs5adc121.23.5 реле

jqx-14fc2cs5adc121.25 реле
jqx-14fc2cs5adc1213.5 реле
jqx-14fc2cs5adc1215 реле
jqx-14fc2cs5adc12nil3.5 реле
jqx-14fc2cs5adc12nil5 реле
jqx-14fc2cs5adc240.83.5 реле
jqx-14fc2cs5adc240.85 реле
jqx-14fc2cs5adc241.23.5 реле
jqx-14fc2cs5adc241.25 реле
jqx-14fc2cs5adc2413.5 реле
jqx-14fc2cs5adc2415 реле
jqx-14fc2cs5adc24nil3.5 реле
jqx-14fc2cs5adc24nil5 реле
jqx-14fc2cs5adc60.83.5 реле
jqx-14fc2cs5adc60.85 реле
jqx-14fc2cs5adc61.23.5 реле
jqx-14fc2cs5adc61.25 реле
jqx-14fc2cs5adc613.5 реле
jqx-14fc2cs5adc615 реле
jqx-14fc2cs5adc6nil3.5 реле
jqx-14fc2cs5adc6nil5 реле
jqx-14fc2cs6 реле
jqx-14fc2cs6aac120.83.5 реле
jqx-14fc2cs6aac120.85 реле
jqx-14fc2cs6aac121.23.5 реле
jqx-14fc2cs6aac121.25 реле
jqx-14fc2cs6aac1213.5 реле
jqx-14fc2cs6aac1215 реле

jqx-14fc2cs6aac12nil3.5 реле
jqx-14fc2cs6aac12nil5 реле
jqx-14fc2cs6aac240.83.5 реле
jqx-14fc2cs6aac240.85 реле
jqx-14fc2cs6aac241.23.5 реле
jqx-14fc2cs6aac241.25 реле
jqx-14fc2cs6aac2413.5 реле
jqx-14fc2cs6aac2415 реле
jqx-14fc2cs6aac24nil3.5 реле
jqx-14fc2cs6aac24nil5 реле
jqx-14fc2cs6aac60.83.5 реле
jqx-14fc2cs6aac60.85 реле
jqx-14fc2cs6aac61.23.5 реле
jqx-14fc2cs6aac61.25 реле
jqx-14fc2cs6aac613.5 реле
jqx-14fc2cs6aac615 реле
jqx-14fc2cs6aac6nil3.5 реле
jqx-14fc2cs6aac6nil5 реле
jqx-14fc2cs6adc120.83.5 реле
jqx-14fc2cs6adc120.85 реле
jqx-14fc2cs6adc121.23.5 реле
jqx-14fc2cs6adc121.25 реле
jqx-14fc2cs6adc1213.5 реле
jqx-14fc2cs6adc1215 реле
jqx-14fc2cs6adc12nil3.5 реле
jqx-14fc2cs6adc12nil5 реле
jqx-14fc2cs6adc240.83.5 реле
jqx-14fc2cs6adc240.85 реле

jqx-14fc2cs6adc241.23.5 реле
jqx-14fc2cs6adc241.25 реле
jqx-14fc2cs6adc2413.5 реле
jqx-14fc2cs6adc2415 реле
jqx-14fc2cs6adc24nil3.5 реле
jqx-14fc2cs6adc24nil5 реле
jqx-14fc2cs6adc60.83.5 реле
jqx-14fc2cs6adc60.85 реле
jqx-14fc2cs6adc61.23.5 реле
jqx-14fc2cs6adc61.25 реле
jqx-14fc2cs6adc613.5 реле
jqx-14fc2cs6adc615 реле
jqx-14fc2cs6adc6nil3.5 реле
jqx-14fc2cs6adc6nil5 реле
jqx-14fc2cs8 реле
jqx-14fc2cz10 реле
jqx-14fc2cz10aac120.83.5 реле
jqx-14fc2cz10aac120.85 реле
jqx-14fc2cz10aac121.23.5 реле
jqx-14fc2cz10aac121.25 реле
jqx-14fc2cz10aac1213.5 реле
jqx-14fc2cz10aac1215 реле
jqx-14fc2cz10aac12nil3.5 реле
jqx-14fc2cz10aac12nil5 реле
jqx-14fc2cz10aac240.83.5 реле
jqx-14fc2cz10aac240.85 реле
jqx-14fc2cz10aac241.23.5 реле
jqx-14fc2cz10aac241.25 реле

jqx-14fc2cz10aac2413.5 реле
jqx-14fc2cz10aac2415 реле
jqx-14fc2cz10aac24nil3.5 реле
jqx-14fc2cz10aac24nil5 реле
jqx-14fc2cz10aac60.83.5 реле
jqx-14fc2cz10aac60.85 реле
jqx-14fc2cz10aac61.23.5 реле
jqx-14fc2cz10aac61.25 реле
jqx-14fc2cz10aac613.5 реле
jqx-14fc2cz10aac615 реле
jqx-14fc2cz10aac6nil3.5 реле
jqx-14fc2cz10aac6nil5 реле
jqx-14fc2cz10adc120.83.5 реле
jqx-14fc2cz10adc120.85 реле
jqx-14fc2cz10adc121.23.5 реле
jqx-14fc2cz10adc121.25 реле
jqx-14fc2cz10adc1213.5 реле
jqx-14fc2cz10adc1215 реле
jqx-14fc2cz10adc12nil3.5 реле
jqx-14fc2cz10adc12nil5 реле
jqx-14fc2cz10adc240.83.5 реле
jqx-14fc2cz10adc240.85 реле
jqx-14fc2cz10adc241.23.5 реле
jqx-14fc2cz10adc241.25 реле
jqx-14fc2cz10adc2413.5 реле
jqx-14fc2cz10adc2415 реле
jqx-14fc2cz10adc24nil3.5 реле
jqx-14fc2cz10adc24nil5 реле

jqx-14fc2cz10adc60.83.5 реле
jqx-14fc2cz10adc60.85 реле
jqx-14fc2cz10adc61.23.5 реле
jqx-14fc2cz10adc61.25 реле
jqx-14fc2cz10adc613.5 реле
jqx-14fc2cz10adc615 реле
jqx-14fc2cz10adc6nil3.5 реле
jqx-14fc2cz10adc6nil5 реле
jqx-14fc2cz16 реле
jqx-14fc2cz20 реле
jqx-14fc2cz20aac120.83.5 реле
jqx-14fc2cz20aac120.85 реле
jqx-14fc2cz20aac121.23.5 реле
jqx-14fc2cz20aac121.25 реле
jqx-14fc2cz20aac1213.5 реле
jqx-14fc2cz20aac1215 реле
jqx-14fc2cz20aac12nil3.5 реле
jqx-14fc2cz20aac12nil5 реле
jqx-14fc2cz20aac240.83.5 реле
jqx-14fc2cz20aac240.85 реле
jqx-14fc2cz20aac241.23.5 реле
jqx-14fc2cz20aac241.25 реле
jqx-14fc2cz20aac2413.5 реле
jqx-14fc2cz20aac2415 реле
jqx-14fc2cz20aac24nil3.5 реле
jqx-14fc2cz20aac24nil5 реле
jqx-14fc2cz20aac60.83.5 реле
jqx-14fc2cz20aac60.85 реле

jqx-14fc2cz20aac61.23.5 реле
jqx-14fc2cz20aac61.25 реле
jqx-14fc2cz20aac613.5 реле
jqx-14fc2cz20aac615 реле
jqx-14fc2cz20aac6nil3.5 реле
jqx-14fc2cz20aac6nil5 реле
jqx-14fc2cz20adc120.83.5 реле
jqx-14fc2cz20adc120.85 реле
jqx-14fc2cz20adc121.23.5 реле
jqx-14fc2cz20adc121.25 реле
jqx-14fc2cz20adc1213.5 реле
jqx-14fc2cz20adc1215 реле
jqx-14fc2cz20adc12nil3.5 реле
jqx-14fc2cz20adc12nil5 реле
jqx-14fc2cz20adc240.83.5 реле
jqx-14fc2cz20adc240.85 реле
jqx-14fc2cz20adc241.23.5 реле
jqx-14fc2cz20adc241.25 реле
jqx-14fc2cz20adc2413.5 реле
jqx-14fc2cz20adc2415 реле
jqx-14fc2cz20adc24nil3.5 реле
jqx-14fc2cz20adc24nil5 реле
jqx-14fc2cz20adc60.83.5 реле
jqx-14fc2cz20adc60.85 реле
jqx-14fc2cz20adc61.23.5 реле
jqx-14fc2cz20adc61.25 реле
jqx-14fc2cz20adc613.5 реле
jqx-14fc2cz20adc615 реле

jqx-14fc2cz20adc6nil3.5 реле
jqx-14fc2cz20adc6nil5 реле
jqx-14fc2cz3 реле
jqx-14fc2cz3aac120.83.5 реле
jqx-14fc2cz3aac120.85 реле
jqx-14fc2cz3aac121.23.5 реле
jqx-14fc2cz3aac121.25 реле
jqx-14fc2cz3aac1213.5 реле
jqx-14fc2cz3aac1215 реле
jqx-14fc2cz3aac12nil3.5 реле
jqx-14fc2cz3aac12nil5 реле
jqx-14fc2cz3aac240.83.5 реле
jqx-14fc2cz3aac240.85 реле
jqx-14fc2cz3aac241.23.5 реле
jqx-14fc2cz3aac241.25 реле
jqx-14fc2cz3aac2413.5 реле
jqx-14fc2cz3aac2415 реле
jqx-14fc2cz3aac24nil3.5 реле
jqx-14fc2cz3aac24nil5 реле
jqx-14fc2cz3aac60.83.5 реле
jqx-14fc2cz3aac60.85 реле
jqx-14fc2cz3aac61.23.5 реле
jqx-14fc2cz3aac61.25 реле
jqx-14fc2cz3aac613.5 реле
jqx-14fc2cz3aac615 реле
jqx-14fc2cz3aac6nil3.5 реле
jqx-14fc2cz3aac6nil5 реле
jqx-14fc2cz3adc120.83.5 реле

jqx-14fc2cz3adc120.85 реле
jqx-14fc2cz3adc121.23.5 реле
jqx-14fc2cz3adc121.25 реле
jqx-14fc2cz3adc1213.5 реле
jqx-14fc2cz3adc1215 реле
jqx-14fc2cz3adc12nil3.5 реле
jqx-14fc2cz3adc12nil5 реле
jqx-14fc2cz3adc240.83.5 реле
jqx-14fc2cz3adc240.85 реле
jqx-14fc2cz3adc241.23.5 реле
jqx-14fc2cz3adc241.25 реле
jqx-14fc2cz3adc2413.5 реле
jqx-14fc2cz3adc2415 реле
jqx-14fc2cz3adc24nil3.5 реле
jqx-14fc2cz3adc24nil5 реле
jqx-14fc2cz3adc60.83.5 реле
jqx-14fc2cz3adc60.85 реле
jqx-14fc2cz3adc61.23.5 реле
jqx-14fc2cz3adc61.25 реле
jqx-14fc2cz3adc613.5 реле
jqx-14fc2cz3adc615 реле
jqx-14fc2cz3adc6nil3.5 реле
jqx-14fc2cz3adc6nil5 реле
jqx-14fc2cz5 реле
jqx-14fc2cz5aac120.83.5 реле
jqx-14fc2cz5aac120.85 реле
jqx-14fc2cz5aac121.23.5 реле
jqx-14fc2cz5aac121.25 реле

jqx-14fc2cz5aac1213.5 реле
jqx-14fc2cz5aac1215 реле
jqx-14fc2cz5aac12nil3.5 реле
jqx-14fc2cz5aac12nil5 реле
jqx-14fc2cz5aac240.83.5 реле
jqx-14fc2cz5aac240.85 реле
jqx-14fc2cz5aac241.23.5 реле
jqx-14fc2cz5aac241.25 реле
jqx-14fc2cz5aac2413.5 реле
jqx-14fc2cz5aac2415 реле
jqx-14fc2cz5aac24nil3.5 реле
jqx-14fc2cz5aac24nil5 реле
jqx-14fc2cz5aac60.83.5 реле
jqx-14fc2cz5aac60.85 реле
jqx-14fc2cz5aac61.23.5 реле
jqx-14fc2cz5aac61.25 реле
jqx-14fc2cz5aac613.5 реле
jqx-14fc2cz5aac615 реле
jqx-14fc2cz5aac6nil3.5 реле
jqx-14fc2cz5aac6nil5 реле
jqx-14fc2cz5adc120.83.5 реле
jqx-14fc2cz5adc120.85 реле
jqx-14fc2cz5adc121.23.5 реле
jqx-14fc2cz5adc121.25 реле
jqx-14fc2cz5adc1213.5 реле
jqx-14fc2cz5adc1215 реле
jqx-14fc2cz5adc12nil3.5 реле
jqx-14fc2cz5adc12nil5 реле

jqx-14fc2cz5adc240.83.5 реле
jqx-14fc2cz5adc240.85 реле
jqx-14fc2cz5adc241.23.5 реле
jqx-14fc2cz5adc241.25 реле
jqx-14fc2cz5adc2413.5 реле
jqx-14fc2cz5adc2415 реле
jqx-14fc2cz5adc24nil3.5 реле
jqx-14fc2cz5adc24nil5 реле
jqx-14fc2cz5adc60.83.5 реле
jqx-14fc2cz5adc60.85 реле
jqx-14fc2cz5adc61.23.5 реле
jqx-14fc2cz5adc61.25 реле
jqx-14fc2cz5adc613.5 реле
jqx-14fc2cz5adc615 реле
jqx-14fc2cz5adc6nil3.5 реле
jqx-14fc2cz5adc6nil5 реле
jqx-14fc2cz6 реле
jqx-14fc2cz6aac120.83.5 реле
jqx-14fc2cz6aac120.85 реле
jqx-14fc2cz6aac121.23.5 реле
jqx-14fc2cz6aac121.25 реле
jqx-14fc2cz6aac1213.5 реле
jqx-14fc2cz6aac1215 реле
jqx-14fc2cz6aac12nil3.5 реле
jqx-14fc2cz6aac12nil5 реле
jqx-14fc2cz6aac240.83.5 реле
jqx-14fc2cz6aac240.85 реле
jqx-14fc2cz6aac241.23.5 реле

jqx-14fc2cz6aac241.25 реле
jqx-14fc2cz6aac2413.5 реле
jqx-14fc2cz6aac2415 реле
jqx-14fc2cz6aac24nil3.5 реле
jqx-14fc2cz6aac24nil5 реле
jqx-14fc2cz6aac60.83.5 реле
jqx-14fc2cz6aac60.85 реле
jqx-14fc2cz6aac61.23.5 реле
jqx-14fc2cz6aac61.25 реле
jqx-14fc2cz6aac613.5 реле
jqx-14fc2cz6aac615 реле
jqx-14fc2cz6aac6nil3.5 реле
jqx-14fc2cz6aac6nil5 реле
jqx-14fc2cz6adc120.83.5 реле
jqx-14fc2cz6adc120.85 реле
jqx-14fc2cz6adc121.23.5 реле
jqx-14fc2cz6adc121.25 реле
jqx-14fc2cz6adc1213.5 реле
jqx-14fc2cz6adc1215 реле
jqx-14fc2cz6adc12nil3.5 реле
jqx-14fc2cz6adc12nil5 реле
jqx-14fc2cz6adc240.83.5 реле
jqx-14fc2cz6adc240.85 реле
jqx-14fc2cz6adc241.23.5 реле
jqx-14fc2cz6adc241.25 реле
jqx-14fc2cz6adc2413.5 реле
jqx-14fc2cz6adc2415 реле
jqx-14fc2cz6adc24nil3.5 реле

jqx-14fc2cz6adc24nil5 реле
jqx-14fc2cz6adc60.83.5 реле
jqx-14fc2cz6adc60.85 реле
jqx-14fc2cz6adc61.23.5 реле
jqx-14fc2cz6adc61.25 реле
jqx-14fc2cz6adc613.5 реле
jqx-14fc2cz6adc615 реле
jqx-14fc2cz6adc6nil3.5 реле
jqx-14fc2cz6adc6nil5 реле
jqx-14fc2cz8 реле
jqx-14fc3 ningbo forward relay corporation
jqx-14fc32as10 реле
jqx-14fc32as16 реле
jqx-14fc32as20 реле
jqx-14fc32as3 реле
jqx-14fc32as5 реле
jqx-14fc32as6 реле
jqx-14fc32as8 реле
jqx-14fc32az10 реле
jqx-14fc32az16 реле
jqx-14fc32az20 реле
jqx-14fc32az3 реле
jqx-14fc32az5 реле
jqx-14fc32az6 реле
jqx-14fc32az8 реле
jqx-14fc32cs10 реле
jqx-14fc32cs16 реле
jqx-14fc32cs20 реле

jqx-14fc32cs3 реле
jqx-14fc32cs5 реле
jqx-14fc32cs6 реле
jqx-14fc32cs8 реле
jqx-14fc32cz10 реле
jqx-14fc32cz16 реле
jqx-14fc32cz20 реле
jqx-14fc32cz3 реле
jqx-14fc32cz5 реле
jqx-14fc32cz6 реле
jqx-14fc32cz8 реле
jqx-14fc3as10 реле
jqx-14fc3as16 реле
jqx-14fc3as20 реле
jqx-14fc3as3 реле
jqx-14fc3as5 реле
jqx-14fc3as6 реле
jqx-14fc3as8 реле
jqx-14fc3az10 реле
jqx-14fc3az16 реле
jqx-14fc3az20 реле
jqx-14fc3az3 реле
jqx-14fc3az5 реле
jqx-14fc3az6 реле
jqx-14fc3az8 реле
jqx-14fc3cs10 реле
jqx-14fc3cs16 реле
jqx-14fc3cs20 реле

jqx-14fc3cs3	реле	
jqx-14fc3cs5	реле	
jqx-14fc3cs6	реле	
jqx-14fc3cs8	реле	
jqx-14fc3cz10	реле	
jqx-14fc3cz16	реле	
jqx-14fc3cz20	реле	
jqx-14fc3cz3	реле	
jqx-14fc3cz5	реле	
jqx-14fc3cz6	реле	
jqx-14fc3cz8	реле	
jqx-14fcas10aac120.83.5		реле
jqx-14fcas10aac120.85	реле	
jqx-14fcas10aac121.23.5		реле
jqx-14fcas10aac121.25	реле	
jqx-14fcas10aac1213.5	реле	
jqx-14fcas10aac1215	реле	
jqx-14fcas10aac12nil3.5		реле
jqx-14fcas10aac12nil5	реле	
jqx-14fcas10aac240.83.5		реле
jqx-14fcas10aac240.85	реле	
jqx-14fcas10aac241.23.5		реле
jqx-14fcas10aac241.25	реле	
jqx-14fcas10aac2413.5	реле	
jqx-14fcas10aac2415	реле	
jqx-14fcas10aac24nil3.5		реле
jqx-14fcas10aac24nil5	реле	
jqx-14fcas10aac60.83.5	реле	

jqx-14fcas10aac60.85 реле
jqx-14fcas10aac61.23.5 реле
jqx-14fcas10aac61.25 реле
jqx-14fcas10aac613.5 реле
jqx-14fcas10aac615 реле
jqx-14fcas10aac6nil3.5 реле
jqx-14fcas10aac6nil5 реле
jqx-14fcas10adc120.83.5 реле
jqx-14fcas10adc120.85 реле
jqx-14fcas10adc121.23.5 реле
jqx-14fcas10adc121.25 реле
jqx-14fcas10adc1213.5 реле
jqx-14fcas10adc1215 реле
jqx-14fcas10adc12nil3.5 реле
jqx-14fcas10adc12nil5 реле
jqx-14fcas10adc240.83.5 реле
jqx-14fcas10adc240.85 реле
jqx-14fcas10adc241.23.5 реле
jqx-14fcas10adc241.25 реле
jqx-14fcas10adc2413.5 реле
jqx-14fcas10adc2415 реле
jqx-14fcas10adc24nil3.5 реле
jqx-14fcas10adc24nil5 реле
jqx-14fcas10adc60.83.5 реле
jqx-14fcas10adc60.85 реле
jqx-14fcas10adc61.23.5 реле
jqx-14fcas10adc61.25 реле
jqx-14fcas10adc613.5 реле

jqx-14fcas10adc615 реле
jqx-14fcas10adc6nil3.5 реле
jqx-14fcas10adc6nil5 реле
jqx-14fcas20aac120.83.5 реле
jqx-14fcas20aac120.85 реле
jqx-14fcas20aac121.23.5 реле
jqx-14fcas20aac121.25 реле
jqx-14fcas20aac1213.5 реле
jqx-14fcas20aac1215 реле
jqx-14fcas20aac12nil3.5 реле
jqx-14fcas20aac12nil5 реле
jqx-14fcas20aac240.83.5 реле
jqx-14fcas20aac240.85 реле
jqx-14fcas20aac241.23.5 реле
jqx-14fcas20aac241.25 реле
jqx-14fcas20aac2413.5 реле
jqx-14fcas20aac2415 реле
jqx-14fcas20aac24nil3.5 реле
jqx-14fcas20aac24nil5 реле
jqx-14fcas20aac60.83.5 реле
jqx-14fcas20aac60.85 реле
jqx-14fcas20aac61.23.5 реле
jqx-14fcas20aac61.25 реле
jqx-14fcas20aac613.5 реле
jqx-14fcas20aac615 реле
jqx-14fcas20aac6nil3.5 реле
jqx-14fcas20aac6nil5 реле
jqx-14fcas20adc120.83.5 реле

jqx-14fcas20adc120.85 реле
jqx-14fcas20adc121.23.5 реле
jqx-14fcas20adc121.25 реле
jqx-14fcas20adc1213.5 реле
jqx-14fcas20adc1215 реле
jqx-14fcas20adc12nil3.5 реле
jqx-14fcas20adc12nil5 реле
jqx-14fcas20adc240.83.5 реле
jqx-14fcas20adc240.85 реле
jqx-14fcas20adc241.23.5 реле
jqx-14fcas20adc241.25 реле
jqx-14fcas20adc2413.5 реле
jqx-14fcas20adc2415 реле
jqx-14fcas20adc24nil3.5 реле
jqx-14fcas20adc24nil5 реле
jqx-14fcas20adc60.83.5 реле
jqx-14fcas20adc60.85 реле
jqx-14fcas20adc61.23.5 реле
jqx-14fcas20adc61.25 реле
jqx-14fcas20adc613.5 реле
jqx-14fcas20adc615 реле
jqx-14fcas20adc6nil3.5 реле
jqx-14fcas20adc6nil5 реле
jqx-14fcas3aac120.83.5 реле
jqx-14fcas3aac120.85 реле
jqx-14fcas3aac121.23.5 реле
jqx-14fcas3aac121.25 реле
jqx-14fcas3aac1213.5 реле

jqx-14fcas3aac1215 реле
jqx-14fcas3aac12nil3.5 реле
jqx-14fcas3aac12nil5 реле
jqx-14fcas3aac240.83.5 реле
jqx-14fcas3aac240.85 реле
jqx-14fcas3aac241.23.5 реле
jqx-14fcas3aac241.25 реле
jqx-14fcas3aac2413.5 реле
jqx-14fcas3aac2415 реле
jqx-14fcas3aac24nil3.5 реле
jqx-14fcas3aac24nil5 реле
jqx-14fcas3aac60.83.5 реле
jqx-14fcas3aac60.85 реле
jqx-14fcas3aac61.23.5 реле
jqx-14fcas3aac61.25 реле
jqx-14fcas3aac613.5 реле
jqx-14fcas3aac615 реле
jqx-14fcas3aac6nil3.5 реле
jqx-14fcas3aac6nil5 реле
jqx-14fcas3adc120.83.5 реле
jqx-14fcas3adc120.85 реле
jqx-14fcas3adc121.23.5 реле
jqx-14fcas3adc121.25 реле
jqx-14fcas3adc1213.5 реле
jqx-14fcas3adc1215 реле
jqx-14fcas3adc12nil3.5 реле
jqx-14fcas3adc12nil5 реле
jqx-14fcas3adc240.83.5 реле

jqx-14fcas3adc240.85 реле
jqx-14fcas3adc241.23.5 реле
jqx-14fcas3adc241.25 реле
jqx-14fcas3adc2413.5 реле
jqx-14fcas3adc2415 реле
jqx-14fcas3adc24nil3.5 реле
jqx-14fcas3adc24nil5 реле
jqx-14fcas3adc60.83.5 реле
jqx-14fcas3adc60.85 реле
jqx-14fcas3adc61.23.5 реле
jqx-14fcas3adc61.25 реле
jqx-14fcas3adc613.5 реле
jqx-14fcas3adc615 реле
jqx-14fcas3adc6nil3.5 реле
jqx-14fcas3adc6nil5 реле
jqx-14fcas5aac120.83.5 реле
jqx-14fcas5aac120.85 реле
jqx-14fcas5aac121.23.5 реле
jqx-14fcas5aac121.25 реле
jqx-14fcas5aac1213.5 реле
jqx-14fcas5aac1215 реле
jqx-14fcas5aac12nil3.5 реле
jqx-14fcas5aac12nil5 реле
jqx-14fcas5aac240.83.5 реле
jqx-14fcas5aac240.85 реле
jqx-14fcas5aac241.23.5 реле
jqx-14fcas5aac241.25 реле
jqx-14fcas5aac2413.5 реле

jqx-14fcas5aac2415 реле
jqx-14fcas5aac24nil3.5 реле
jqx-14fcas5aac24nil5 реле
jqx-14fcas5aac60.83.5 реле
jqx-14fcas5aac60.85 реле
jqx-14fcas5aac61.23.5 реле
jqx-14fcas5aac61.25 реле
jqx-14fcas5aac613.5 реле
jqx-14fcas5aac615 реле
jqx-14fcas5aac6nil3.5 реле
jqx-14fcas5aac6nil5 реле
jqx-14fcas5adc120.83.5 реле
jqx-14fcas5adc120.85 реле
jqx-14fcas5adc121.23.5 реле
jqx-14fcas5adc121.25 реле
jqx-14fcas5adc1213.5 реле
jqx-14fcas5adc1215 реле
jqx-14fcas5adc12nil3.5 реле
jqx-14fcas5adc12nil5 реле
jqx-14fcas5adc240.83.5 реле
jqx-14fcas5adc240.85 реле
jqx-14fcas5adc241.23.5 реле
jqx-14fcas5adc241.25 реле
jqx-14fcas5adc2413.5 реле
jqx-14fcas5adc2415 реле
jqx-14fcas5adc24nil3.5 реле
jqx-14fcas5adc24nil5 реле
jqx-14fcas5adc60.83.5 реле

jqx-14fcas5adc60.85 реле
jqx-14fcas5adc61.23.5 реле
jqx-14fcas5adc61.25 реле
jqx-14fcas5adc613.5 реле
jqx-14fcas5adc615 реле
jqx-14fcas5adc6nil3.5 реле
jqx-14fcas5adc6nil5 реле
jqx-14fcas6aac120.83.5 реле
jqx-14fcas6aac120.85 реле
jqx-14fcas6aac121.23.5 реле
jqx-14fcas6aac121.25 реле
jqx-14fcas6aac1213.5 реле
jqx-14fcas6aac1215 реле
jqx-14fcas6aac12nil3.5 реле
jqx-14fcas6aac12nil5 реле
jqx-14fcas6aac240.83.5 реле
jqx-14fcas6aac240.85 реле
jqx-14fcas6aac241.23.5 реле
jqx-14fcas6aac241.25 реле
jqx-14fcas6aac2413.5 реле
jqx-14fcas6aac2415 реле
jqx-14fcas6aac24nil3.5 реле
jqx-14fcas6aac24nil5 реле
jqx-14fcas6aac60.83.5 реле
jqx-14fcas6aac60.85 реле
jqx-14fcas6aac61.23.5 реле
jqx-14fcas6aac61.25 реле
jqx-14fcas6aac613.5 реле

jqx-14fcas6aac615 реле
jqx-14fcas6aac6nil3.5 реле
jqx-14fcas6aac6nil5 реле
jqx-14fcas6adc120.83.5 реле
jqx-14fcas6adc120.85 реле
jqx-14fcas6adc121.23.5 реле
jqx-14fcas6adc121.25 реле
jqx-14fcas6adc1213.5 реле
jqx-14fcas6adc1215 реле
jqx-14fcas6adc12nil3.5 реле
jqx-14fcas6adc12nil5 реле
jqx-14fcas6adc240.83.5 реле
jqx-14fcas6adc240.85 реле
jqx-14fcas6adc241.23.5 реле
jqx-14fcas6adc241.25 реле
jqx-14fcas6adc2413.5 реле
jqx-14fcas6adc2415 реле
jqx-14fcas6adc24nil3.5 реле
jqx-14fcas6adc24nil5 реле
jqx-14fcas6adc60.83.5 реле
jqx-14fcas6adc60.85 реле
jqx-14fcas6adc61.23.5 реле
jqx-14fcas6adc61.25 реле
jqx-14fcas6adc613.5 реле
jqx-14fcas6adc615 реле
jqx-14fcas6adc6nil3.5 реле
jqx-14fcas6adc6nil5 реле
jqx-14fcaz10aac120.83.5 реле

jqx-14fcaz10aac120.85 реле
jqx-14fcaz10aac121.23.5 реле
jqx-14fcaz10aac121.25 реле
jqx-14fcaz10aac1213.5 реле
jqx-14fcaz10aac1215 реле
jqx-14fcaz10aac12nil3.5 реле
jqx-14fcaz10aac12nil5 реле
jqx-14fcaz10aac240.83.5 реле
jqx-14fcaz10aac240.85 реле
jqx-14fcaz10aac241.23.5 реле
jqx-14fcaz10aac241.25 реле
jqx-14fcaz10aac2413.5 реле
jqx-14fcaz10aac2415 реле
jqx-14fcaz10aac24nil3.5 реле
jqx-14fcaz10aac24nil5 реле
jqx-14fcaz10aac60.83.5 реле
jqx-14fcaz10aac60.85 реле
jqx-14fcaz10aac61.23.5 реле
jqx-14fcaz10aac61.25 реле
jqx-14fcaz10aac613.5 реле
jqx-14fcaz10aac615 реле
jqx-14fcaz10aac6nil3.5 реле
jqx-14fcaz10aac6nil5 реле
jqx-14fcaz10adc120.83.5 реле
jqx-14fcaz10adc120.85 реле
jqx-14fcaz10adc121.23.5 реле
jqx-14fcaz10adc121.25 реле
jqx-14fcaz10adc1213.5 реле

jqx-14fcaz10adc1215 реле
jqx-14fcaz10adc12nil3.5 реле
jqx-14fcaz10adc12nil5 реле
jqx-14fcaz10adc240.83.5 реле
jqx-14fcaz10adc240.85 реле
jqx-14fcaz10adc241.23.5 реле
jqx-14fcaz10adc241.25 реле
jqx-14fcaz10adc2413.5 реле
jqx-14fcaz10adc2415 реле
jqx-14fcaz10adc24nil3.5 реле
jqx-14fcaz10adc24nil5 реле
jqx-14fcaz10adc60.83.5 реле
jqx-14fcaz10adc60.85 реле
jqx-14fcaz10adc61.23.5 реле
jqx-14fcaz10adc61.25 реле
jqx-14fcaz10adc613.5 реле
jqx-14fcaz10adc615 реле
jqx-14fcaz10adc6nil3.5 реле
jqx-14fcaz10adc6nil5 реле
jqx-14fcaz20aac120.83.5 реле
jqx-14fcaz20aac120.85 реле
jqx-14fcaz20aac121.23.5 реле
jqx-14fcaz20aac121.25 реле
jqx-14fcaz20aac1213.5 реле
jqx-14fcaz20aac1215 реле
jqx-14fcaz20aac12nil3.5 реле
jqx-14fcaz20aac12nil5 реле
jqx-14fcaz20aac240.83.5 реле

jqx-14fcaz20aac240.85 реле
jqx-14fcaz20aac241.23.5 реле
jqx-14fcaz20aac241.25 реле
jqx-14fcaz20aac2413.5 реле
jqx-14fcaz20aac2415 реле
jqx-14fcaz20aac24nil3.5 реле
jqx-14fcaz20aac24nil5 реле
jqx-14fcaz20aac60.83.5 реле
jqx-14fcaz20aac60.85 реле
jqx-14fcaz20aac61.23.5 реле
jqx-14fcaz20aac61.25 реле
jqx-14fcaz20aac613.5 реле
jqx-14fcaz20aac615 реле
jqx-14fcaz20aac6nil3.5 реле
jqx-14fcaz20aac6nil5 реле
jqx-14fcaz20adc120.83.5 реле
jqx-14fcaz20adc120.85 реле
jqx-14fcaz20adc121.23.5 реле
jqx-14fcaz20adc121.25 реле
jqx-14fcaz20adc1213.5 реле
jqx-14fcaz20adc1215 реле
jqx-14fcaz20adc12nil3.5 реле
jqx-14fcaz20adc12nil5 реле
jqx-14fcaz20adc240.83.5 реле
jqx-14fcaz20adc240.85 реле
jqx-14fcaz20adc241.23.5 реле
jqx-14fcaz20adc241.25 реле
jqx-14fcaz20adc2413.5 реле

jqx-14fcaz20adc2415 реле
jqx-14fcaz20adc24nil3.5 реле
jqx-14fcaz20adc24nil5 реле
jqx-14fcaz20adc60.83.5 реле
jqx-14fcaz20adc60.85 реле
jqx-14fcaz20adc61.23.5 реле
jqx-14fcaz20adc61.25 реле
jqx-14fcaz20adc613.5 реле
jqx-14fcaz20adc615 реле
jqx-14fcaz20adc6nil3.5 реле
jqx-14fcaz20adc6nil5 реле
jqx-14fcaz3aac120.83.5 реле
jqx-14fcaz3aac120.85 реле
jqx-14fcaz3aac121.23.5 реле
jqx-14fcaz3aac121.25 реле
jqx-14fcaz3aac1213.5 реле
jqx-14fcaz3aac1215 реле
jqx-14fcaz3aac12nil3.5 реле
jqx-14fcaz3aac12nil5 реле
jqx-14fcaz3aac240.83.5 реле
jqx-14fcaz3aac240.85 реле
jqx-14fcaz3aac241.23.5 реле
jqx-14fcaz3aac241.25 реле
jqx-14fcaz3aac2413.5 реле
jqx-14fcaz3aac2415 реле
jqx-14fcaz3aac24nil3.5 реле
jqx-14fcaz3aac24nil5 реле
jqx-14fcaz3aac60.83.5 реле

jqx-14fcaz3aac60.85 реле
jqx-14fcaz3aac61.23.5 реле
jqx-14fcaz3aac61.25 реле
jqx-14fcaz3aac613.5 реле
jqx-14fcaz3aac615 реле
jqx-14fcaz3aac6nil3.5 реле
jqx-14fcaz3aac6nil5 реле
jqx-14fcaz3adc120.83.5 реле
jqx-14fcaz3adc120.85 реле
jqx-14fcaz3adc121.23.5 реле
jqx-14fcaz3adc121.25 реле
jqx-14fcaz3adc1213.5 реле
jqx-14fcaz3adc1215 реле
jqx-14fcaz3adc12nil3.5 реле
jqx-14fcaz3adc12nil5 реле
jqx-14fcaz3adc240.83.5 реле
jqx-14fcaz3adc240.85 реле
jqx-14fcaz3adc241.23.5 реле
jqx-14fcaz3adc241.25 реле
jqx-14fcaz3adc2413.5 реле
jqx-14fcaz3adc2415 реле
jqx-14fcaz3adc24nil3.5 реле
jqx-14fcaz3adc24nil5 реле
jqx-14fcaz3adc60.83.5 реле
jqx-14fcaz3adc60.85 реле
jqx-14fcaz3adc61.23.5 реле
jqx-14fcaz3adc61.25 реле
jqx-14fcaz3adc613.5 реле

jqx-14fcaz3adc615 реле
jqx-14fcaz3adc6nil3.5 реле
jqx-14fcaz3adc6nil5 реле
jqx-14fcaz5aac120.83.5 реле
jqx-14fcaz5aac120.85 реле
jqx-14fcaz5aac121.23.5 реле
jqx-14fcaz5aac121.25 реле
jqx-14fcaz5aac1213.5 реле
jqx-14fcaz5aac1215 реле
jqx-14fcaz5aac12nil3.5 реле
jqx-14fcaz5aac12nil5 реле
jqx-14fcaz5aac240.83.5 реле
jqx-14fcaz5aac240.85 реле
jqx-14fcaz5aac241.23.5 реле
jqx-14fcaz5aac241.25 реле
jqx-14fcaz5aac2413.5 реле
jqx-14fcaz5aac2415 реле
jqx-14fcaz5aac24nil3.5 реле
jqx-14fcaz5aac24nil5 реле
jqx-14fcaz5aac60.83.5 реле
jqx-14fcaz5aac60.85 реле
jqx-14fcaz5aac61.23.5 реле
jqx-14fcaz5aac61.25 реле
jqx-14fcaz5aac613.5 реле
jqx-14fcaz5aac615 реле
jqx-14fcaz5aac6nil3.5 реле
jqx-14fcaz5aac6nil5 реле
jqx-14fcaz5adc120.83.5 реле

jqx-14fcaz5adc120.85 реле
jqx-14fcaz5adc121.23.5 реле
jqx-14fcaz5adc121.25 реле
jqx-14fcaz5adc1213.5 реле
jqx-14fcaz5adc1215 реле
jqx-14fcaz5adc12nil3.5 реле
jqx-14fcaz5adc12nil5 реле
jqx-14fcaz5adc240.83.5 реле
jqx-14fcaz5adc240.85 реле
jqx-14fcaz5adc241.23.5 реле
jqx-14fcaz5adc241.25 реле
jqx-14fcaz5adc2413.5 реле
jqx-14fcaz5adc2415 реле
jqx-14fcaz5adc24nil3.5 реле
jqx-14fcaz5adc24nil5 реле
jqx-14fcaz5adc60.83.5 реле
jqx-14fcaz5adc60.85 реле
jqx-14fcaz5adc61.23.5 реле
jqx-14fcaz5adc61.25 реле
jqx-14fcaz5adc613.5 реле
jqx-14fcaz5adc615 реле
jqx-14fcaz5adc6nil3.5 реле
jqx-14fcaz5adc6nil5 реле
jqx-14fcaz6aac120.83.5 реле
jqx-14fcaz6aac120.85 реле
jqx-14fcaz6aac121.23.5 реле
jqx-14fcaz6aac121.25 реле
jqx-14fcaz6aac1213.5 реле

jqx-14fcaz6aac1215 реле
jqx-14fcaz6aac12nil3.5 реле
jqx-14fcaz6aac12nil5 реле
jqx-14fcaz6aac240.83.5 реле
jqx-14fcaz6aac240.85 реле
jqx-14fcaz6aac241.23.5 реле
jqx-14fcaz6aac241.25 реле
jqx-14fcaz6aac2413.5 реле
jqx-14fcaz6aac2415 реле
jqx-14fcaz6aac24nil3.5 реле
jqx-14fcaz6aac24nil5 реле
jqx-14fcaz6aac60.83.5 реле
jqx-14fcaz6aac60.85 реле
jqx-14fcaz6aac61.23.5 реле
jqx-14fcaz6aac61.25 реле
jqx-14fcaz6aac613.5 реле
jqx-14fcaz6aac615 реле
jqx-14fcaz6aac6nil3.5 реле
jqx-14fcaz6aac6nil5 реле
jqx-14fcaz6adc120.83.5 реле
jqx-14fcaz6adc120.85 реле
jqx-14fcaz6adc121.23.5 реле
jqx-14fcaz6adc121.25 реле
jqx-14fcaz6adc1213.5 реле
jqx-14fcaz6adc1215 реле
jqx-14fcaz6adc12nil3.5 реле
jqx-14fcaz6adc12nil5 реле
jqx-14fcaz6adc240.83.5 реле

jqx-14fcaz6adc240.85 реле
jqx-14fcaz6adc241.23.5 реле
jqx-14fcaz6adc241.25 реле
jqx-14fcaz6adc2413.5 реле
jqx-14fcaz6adc2415 реле
jqx-14fcaz6adc24nil3.5 реле
jqx-14fcaz6adc24nil5 реле
jqx-14fcaz6adc60.83.5 реле
jqx-14fcaz6adc60.85 реле
jqx-14fcaz6adc61.23.5 реле
jqx-14fcaz6adc61.25 реле
jqx-14fcaz6adc613.5 реле
jqx-14fcaz6adc615 реле
jqx-14fcaz6adc6nil3.5 реле
jqx-14fcaz6adc6nil5 реле
jqx-14fcss10aac120.83.5 реле
jqx-14fcss10aac120.85 реле
jqx-14fcss10aac121.23.5 реле
jqx-14fcss10aac121.25 реле
jqx-14fcss10aac1213.5 реле
jqx-14fcss10aac1215 реле
jqx-14fcss10aac12nil3.5 реле
jqx-14fcss10aac12nil5 реле
jqx-14fcss10aac240.83.5 реле
jqx-14fcss10aac240.85 реле
jqx-14fcss10aac241.23.5 реле
jqx-14fcss10aac241.25 реле
jqx-14fcss10aac2413.5 реле

jqx-14fcss10aac2415 реле
jqx-14fcss10aac24nil3.5 реле
jqx-14fcss10aac24nil5 реле
jqx-14fcss10aac60.83.5 реле
jqx-14fcss10aac60.85 реле
jqx-14fcss10aac61.23.5 реле
jqx-14fcss10aac61.25 реле
jqx-14fcss10aac613.5 реле
jqx-14fcss10aac615 реле
jqx-14fcss10aac6nil3.5 реле
jqx-14fcss10aac6nil5 реле
jqx-14fcss10adc120.83.5 реле
jqx-14fcss10adc120.85 реле
jqx-14fcss10adc121.23.5 реле
jqx-14fcss10adc121.25 реле
jqx-14fcss10adc1213.5 реле
jqx-14fcss10adc1215 реле
jqx-14fcss10adc12nil3.5 реле
jqx-14fcss10adc12nil5 реле
jqx-14fcss10adc240.83.5 реле
jqx-14fcss10adc240.85 реле
jqx-14fcss10adc241.23.5 реле
jqx-14fcss10adc241.25 реле
jqx-14fcss10adc2413.5 реле
jqx-14fcss10adc2415 реле
jqx-14fcss10adc24nil3.5 реле
jqx-14fcss10adc24nil5 реле
jqx-14fcss10adc60.83.5 реле

jqx-14fccs10adc60.85 реле
jqx-14fccs10adc61.23.5 реле
jqx-14fccs10adc61.25 реле
jqx-14fccs10adc613.5 реле
jqx-14fccs10adc615 реле
jqx-14fccs10adc6nil3.5 реле
jqx-14fccs10adc6nil5 реле
jqx-14fccs10dc12v0.83.5 ningbo forward relay corporation
jqx-14fccs20aac120.83.5 реле
jqx-14fccs20aac120.85 реле
jqx-14fccs20aac121.23.5 реле
jqx-14fccs20aac121.25 реле
jqx-14fccs20aac1213.5 реле
jqx-14fccs20aac1215 реле
jqx-14fccs20aac12nil3.5 реле
jqx-14fccs20aac12nil5 реле
jqx-14fccs20aac240.83.5 реле
jqx-14fccs20aac240.85 реле
jqx-14fccs20aac241.23.5 реле
jqx-14fccs20aac241.25 реле
jqx-14fccs20aac2413.5 реле
jqx-14fccs20aac2415 реле
jqx-14fccs20aac24nil3.5 реле
jqx-14fccs20aac24nil5 реле
jqx-14fccs20aac60.83.5 реле
jqx-14fccs20aac60.85 реле
jqx-14fccs20aac61.23.5 реле
jqx-14fccs20aac61.25 реле

jqx-14fcss20aac613.5 реле
jqx-14fcss20aac615 реле
jqx-14fcss20aac6nil3.5 реле
jqx-14fcss20aac6nil5 реле
jqx-14fcss20adc120.83.5 реле
jqx-14fcss20adc120.85 реле
jqx-14fcss20adc121.23.5 реле
jqx-14fcss20adc121.25 реле
jqx-14fcss20adc1213.5 реле
jqx-14fcss20adc1215 реле
jqx-14fcss20adc12nil3.5 реле
jqx-14fcss20adc12nil5 реле
jqx-14fcss20adc240.83.5 реле
jqx-14fcss20adc240.85 реле
jqx-14fcss20adc241.23.5 реле
jqx-14fcss20adc241.25 реле
jqx-14fcss20adc2413.5 реле
jqx-14fcss20adc2415 реле
jqx-14fcss20adc24nil3.5 реле
jqx-14fcss20adc24nil5 реле
jqx-14fcss20adc60.83.5 реле
jqx-14fcss20adc60.85 реле
jqx-14fcss20adc61.23.5 реле
jqx-14fcss20adc61.25 реле
jqx-14fcss20adc613.5 реле
jqx-14fcss20adc615 реле
jqx-14fcss20adc6nil3.5 реле
jqx-14fcss20adc6nil5 реле

jqx-14fcss3aac120.83.5 реле
jqx-14fcss3aac120.85 реле
jqx-14fcss3aac121.23.5 реле
jqx-14fcss3aac121.25 реле
jqx-14fcss3aac1213.5 реле
jqx-14fcss3aac1215 реле
jqx-14fcss3aac12nil3.5 реле
jqx-14fcss3aac12nil5 реле
jqx-14fcss3aac240.83.5 реле
jqx-14fcss3aac240.85 реле
jqx-14fcss3aac241.23.5 реле
jqx-14fcss3aac241.25 реле
jqx-14fcss3aac2413.5 реле
jqx-14fcss3aac2415 реле
jqx-14fcss3aac24nil3.5 реле
jqx-14fcss3aac24nil5 реле
jqx-14fcss3aac60.83.5 реле
jqx-14fcss3aac60.85 реле
jqx-14fcss3aac61.23.5 реле
jqx-14fcss3aac61.25 реле
jqx-14fcss3aac613.5 реле
jqx-14fcss3aac615 реле
jqx-14fcss3aac6nil3.5 реле
jqx-14fcss3aac6nil5 реле
jqx-14fcss3adc120.83.5 реле
jqx-14fcss3adc120.85 реле
jqx-14fcss3adc121.23.5 реле
jqx-14fcss3adc121.25 реле

jqx-14fccc3adc1213.5 реле
jqx-14fccc3adc1215 реле
jqx-14fccc3adc12nil3.5 реле
jqx-14fccc3adc12nil5 реле
jqx-14fccc3adc240.83.5 реле
jqx-14fccc3adc240.85 реле
jqx-14fccc3adc241.23.5 реле
jqx-14fccc3adc241.25 реле
jqx-14fccc3adc2413.5 реле
jqx-14fccc3adc2415 реле
jqx-14fccc3adc24nil3.5 реле
jqx-14fccc3adc24nil5 реле
jqx-14fccc3adc60.83.5 реле
jqx-14fccc3adc60.85 реле
jqx-14fccc3adc61.23.5 реле
jqx-14fccc3adc61.25 реле
jqx-14fccc3adc613.5 реле
jqx-14fccc3adc615 реле
jqx-14fccc3adc6nil3.5 реле
jqx-14fccc3adc6nil5 реле
jqx-14fccc5aac120.83.5 реле
jqx-14fccc5aac120.85 реле
jqx-14fccc5aac121.23.5 реле
jqx-14fccc5aac121.25 реле
jqx-14fccc5aac1213.5 реле
jqx-14fccc5aac1215 реле
jqx-14fccc5aac12nil3.5 реле
jqx-14fccc5aac12nil5 реле

jqx-14fccs5aac240.83.5 реле
jqx-14fccs5aac240.85 реле
jqx-14fccs5aac241.23.5 реле
jqx-14fccs5aac241.25 реле
jqx-14fccs5aac2413.5 реле
jqx-14fccs5aac2415 реле
jqx-14fccs5aac24nil3.5 реле
jqx-14fccs5aac24nil5 реле
jqx-14fccs5aac60.83.5 реле
jqx-14fccs5aac60.85 реле
jqx-14fccs5aac61.23.5 реле
jqx-14fccs5aac61.25 реле
jqx-14fccs5aac613.5 реле
jqx-14fccs5aac615 реле
jqx-14fccs5aac6nil3.5 реле
jqx-14fccs5aac6nil5 реле
jqx-14fccs5adc120.83.5 реле
jqx-14fccs5adc120.85 реле
jqx-14fccs5adc121.23.5 реле
jqx-14fccs5adc121.25 реле
jqx-14fccs5adc1213.5 реле
jqx-14fccs5adc1215 реле
jqx-14fccs5adc12nil3.5 реле
jqx-14fccs5adc12nil5 реле
jqx-14fccs5adc240.83.5 реле
jqx-14fccs5adc240.85 реле
jqx-14fccs5adc241.23.5 реле
jqx-14fccs5adc241.25 реле

jqx-14fcss5adc2413.5 реле
jqx-14fcss5adc2415 реле
jqx-14fcss5adc24nil3.5 реле
jqx-14fcss5adc24nil5 реле
jqx-14fcss5adc60.83.5 реле
jqx-14fcss5adc60.85 реле
jqx-14fcss5adc61.23.5 реле
jqx-14fcss5adc61.25 реле
jqx-14fcss5adc613.5 реле
jqx-14fcss5adc615 реле
jqx-14fcss5adc6nil3.5 реле
jqx-14fcss5adc6nil5 реле
jqx-14fcss6aac120.83.5 реле
jqx-14fcss6aac120.85 реле
jqx-14fcss6aac121.23.5 реле
jqx-14fcss6aac121.25 реле
jqx-14fcss6aac1213.5 реле
jqx-14fcss6aac1215 реле
jqx-14fcss6aac12nil3.5 реле
jqx-14fcss6aac12nil5 реле
jqx-14fcss6aac240.83.5 реле
jqx-14fcss6aac240.85 реле
jqx-14fcss6aac241.23.5 реле
jqx-14fcss6aac241.25 реле
jqx-14fcss6aac2413.5 реле
jqx-14fcss6aac2415 реле
jqx-14fcss6aac24nil3.5 реле
jqx-14fcss6aac24nil5 реле

jqx-14fcss6aac60.83.5 реле
jqx-14fcss6aac60.85 реле
jqx-14fcss6aac61.23.5 реле
jqx-14fcss6aac61.25 реле
jqx-14fcss6aac613.5 реле
jqx-14fcss6aac615 реле
jqx-14fcss6aac6nil3.5 реле
jqx-14fcss6aac6nil5 реле
jqx-14fcss6adc120.83.5 реле
jqx-14fcss6adc120.85 реле
jqx-14fcss6adc121.23.5 реле
jqx-14fcss6adc121.25 реле
jqx-14fcss6adc1213.5 реле
jqx-14fcss6adc1215 реле
jqx-14fcss6adc12nil3.5 реле
jqx-14fcss6adc12nil5 реле
jqx-14fcss6adc240.83.5 реле
jqx-14fcss6adc240.85 реле
jqx-14fcss6adc241.23.5 реле
jqx-14fcss6adc241.25 реле
jqx-14fcss6adc2413.5 реле
jqx-14fcss6adc2415 реле
jqx-14fcss6adc24nil3.5 реле
jqx-14fcss6adc24nil5 реле
jqx-14fcss6adc60.83.5 реле
jqx-14fcss6adc60.85 реле
jqx-14fcss6adc61.23.5 реле
jqx-14fcss6adc61.25 реле

jqx-14fcss6adc613.5 реле
jqx-14fcss6adc615 реле
jqx-14fcss6adc6nil3.5 реле
jqx-14fcss6adc6nil5 реле
jqx-14fccz10aac120.83.5 реле
jqx-14fccz10aac120.85 реле
jqx-14fccz10aac121.23.5 реле
jqx-14fccz10aac121.25 реле
jqx-14fccz10aac1213.5 реле
jqx-14fccz10aac1215 реле
jqx-14fccz10aac12nil3.5 реле
jqx-14fccz10aac12nil5 реле
jqx-14fccz10aac240.83.5 реле
jqx-14fccz10aac240.85 реле
jqx-14fccz10aac241.23.5 реле
jqx-14fccz10aac241.25 реле
jqx-14fccz10aac2413.5 реле
jqx-14fccz10aac2415 реле
jqx-14fccz10aac24nil3.5 реле
jqx-14fccz10aac24nil5 реле
jqx-14fccz10aac60.83.5 реле
jqx-14fccz10aac60.85 реле
jqx-14fccz10aac61.23.5 реле
jqx-14fccz10aac61.25 реле
jqx-14fccz10aac613.5 реле
jqx-14fccz10aac615 реле
jqx-14fccz10aac6nil3.5 реле
jqx-14fccz10aac6nil5 реле

jqx-14fccz10adc120.83.5 реле
jqx-14fccz10adc120.85 реле
jqx-14fccz10adc121.23.5 реле
jqx-14fccz10adc121.25 реле
jqx-14fccz10adc1213.5 реле
jqx-14fccz10adc1215 реле
jqx-14fccz10adc12nil3.5 реле
jqx-14fccz10adc12nil5 реле
jqx-14fccz10adc240.83.5 реле
jqx-14fccz10adc240.85 реле
jqx-14fccz10adc241.23.5 реле
jqx-14fccz10adc241.25 реле
jqx-14fccz10adc2413.5 реле
jqx-14fccz10adc2415 реле
jqx-14fccz10adc24nil3.5 реле
jqx-14fccz10adc24nil5 реле
jqx-14fccz10adc60.83.5 реле
jqx-14fccz10adc60.85 реле
jqx-14fccz10adc61.23.5 реле
jqx-14fccz10adc61.25 реле
jqx-14fccz10adc613.5 реле
jqx-14fccz10adc615 реле
jqx-14fccz10adc6nil3.5 реле
jqx-14fccz10adc6nil5 реле
jqx-14fccz20aac120.83.5 реле
jqx-14fccz20aac120.85 реле
jqx-14fccz20aac121.23.5 реле
jqx-14fccz20aac121.25 реле

jqx-14fccz20aac1213.5 реле
jqx-14fccz20aac1215 реле
jqx-14fccz20aac12nil3.5 реле
jqx-14fccz20aac12nil5 реле
jqx-14fccz20aac240.83.5 реле
jqx-14fccz20aac240.85 реле
jqx-14fccz20aac241.23.5 реле
jqx-14fccz20aac241.25 реле
jqx-14fccz20aac2413.5 реле
jqx-14fccz20aac2415 реле
jqx-14fccz20aac24nil3.5 реле
jqx-14fccz20aac24nil5 реле
jqx-14fccz20aac60.83.5 реле
jqx-14fccz20aac60.85 реле
jqx-14fccz20aac61.23.5 реле
jqx-14fccz20aac61.25 реле
jqx-14fccz20aac613.5 реле
jqx-14fccz20aac615 реле
jqx-14fccz20aac6nil3.5 реле
jqx-14fccz20aac6nil5 реле
jqx-14fccz20adc120.83.5 реле
jqx-14fccz20adc120.85 реле
jqx-14fccz20adc121.23.5 реле
jqx-14fccz20adc121.25 реле
jqx-14fccz20adc1213.5 реле
jqx-14fccz20adc1215 реле
jqx-14fccz20adc12nil3.5 реле
jqx-14fccz20adc12nil5 реле

jqx-14fccz20adc240.83.5 реле
jqx-14fccz20adc240.85 реле
jqx-14fccz20adc241.23.5 реле
jqx-14fccz20adc241.25 реле
jqx-14fccz20adc2413.5 реле
jqx-14fccz20adc2415 реле
jqx-14fccz20adc24nil3.5 реле
jqx-14fccz20adc24nil5 реле
jqx-14fccz20adc60.83.5 реле
jqx-14fccz20adc60.85 реле
jqx-14fccz20adc61.23.5 реле
jqx-14fccz20adc61.25 реле
jqx-14fccz20adc613.5 реле
jqx-14fccz20adc615 реле
jqx-14fccz20adc6nil3.5 реле
jqx-14fccz20adc6nil5 реле
jqx-14fccz3aac120.83.5 реле
jqx-14fccz3aac120.85 реле
jqx-14fccz3aac121.23.5 реле
jqx-14fccz3aac121.25 реле
jqx-14fccz3aac1213.5 реле
jqx-14fccz3aac1215 реле
jqx-14fccz3aac12nil3.5 реле
jqx-14fccz3aac12nil5 реле
jqx-14fccz3aac240.83.5 реле
jqx-14fccz3aac240.85 реле
jqx-14fccz3aac241.23.5 реле
jqx-14fccz3aac241.25 реле

jqx-14fccz3aac2413.5 реле
jqx-14fccz3aac2415 реле
jqx-14fccz3aac24nil3.5 реле
jqx-14fccz3aac24nil5 реле
jqx-14fccz3aac60.83.5 реле
jqx-14fccz3aac60.85 реле
jqx-14fccz3aac61.23.5 реле
jqx-14fccz3aac61.25 реле
jqx-14fccz3aac613.5 реле
jqx-14fccz3aac615 реле
jqx-14fccz3aac6nil3.5 реле
jqx-14fccz3aac6nil5 реле
jqx-14fccz3adc120.83.5 реле
jqx-14fccz3adc120.85 реле
jqx-14fccz3adc121.23.5 реле
jqx-14fccz3adc121.25 реле
jqx-14fccz3adc1213.5 реле
jqx-14fccz3adc1215 реле
jqx-14fccz3adc12nil3.5 реле
jqx-14fccz3adc12nil5 реле
jqx-14fccz3adc240.83.5 реле
jqx-14fccz3adc240.85 реле
jqx-14fccz3adc241.23.5 реле
jqx-14fccz3adc241.25 реле
jqx-14fccz3adc2413.5 реле
jqx-14fccz3adc2415 реле
jqx-14fccz3adc24nil3.5 реле
jqx-14fccz3adc24nil5 реле

jqx-14fccz3adc60.83.5 реле
jqx-14fccz3adc60.85 реле
jqx-14fccz3adc61.23.5 реле
jqx-14fccz3adc61.25 реле
jqx-14fccz3adc613.5 реле
jqx-14fccz3adc615 реле
jqx-14fccz3adc6nil3.5 реле
jqx-14fccz3adc6nil5 реле
jqx-14fccz5aac120.83.5 реле
jqx-14fccz5aac120.85 реле
jqx-14fccz5aac121.23.5 реле
jqx-14fccz5aac121.25 реле
jqx-14fccz5aac1213.5 реле
jqx-14fccz5aac1215 реле
jqx-14fccz5aac12nil3.5 реле
jqx-14fccz5aac12nil5 реле
jqx-14fccz5aac240.83.5 реле
jqx-14fccz5aac240.85 реле
jqx-14fccz5aac241.23.5 реле
jqx-14fccz5aac241.25 реле
jqx-14fccz5aac2413.5 реле
jqx-14fccz5aac2415 реле
jqx-14fccz5aac24nil3.5 реле
jqx-14fccz5aac24nil5 реле
jqx-14fccz5aac60.83.5 реле
jqx-14fccz5aac60.85 реле
jqx-14fccz5aac61.23.5 реле
jqx-14fccz5aac61.25 реле

jqx-14fccz5aac613.5 реле
jqx-14fccz5aac615 реле
jqx-14fccz5aac6nil3.5 реле
jqx-14fccz5aac6nil5 реле
jqx-14fccz5adc120.83.5 реле
jqx-14fccz5adc120.85 реле
jqx-14fccz5adc121.23.5 реле
jqx-14fccz5adc121.25 реле
jqx-14fccz5adc1213.5 реле
jqx-14fccz5adc1215 реле
jqx-14fccz5adc12nil3.5 реле
jqx-14fccz5adc12nil5 реле
jqx-14fccz5adc240.83.5 реле
jqx-14fccz5adc240.85 реле
jqx-14fccz5adc241.23.5 реле
jqx-14fccz5adc241.25 реле
jqx-14fccz5adc2413.5 реле
jqx-14fccz5adc2415 реле
jqx-14fccz5adc24nil3.5 реле
jqx-14fccz5adc24nil5 реле
jqx-14fccz5adc60.83.5 реле
jqx-14fccz5adc60.85 реле
jqx-14fccz5adc61.23.5 реле
jqx-14fccz5adc61.25 реле
jqx-14fccz5adc613.5 реле
jqx-14fccz5adc615 реле
jqx-14fccz5adc6nil3.5 реле
jqx-14fccz5adc6nil5 реле

jqx-14fccz6aac120.83.5 реле
jqx-14fccz6aac120.85 реле
jqx-14fccz6aac121.23.5 реле
jqx-14fccz6aac121.25 реле
jqx-14fccz6aac1213.5 реле
jqx-14fccz6aac1215 реле
jqx-14fccz6aac12nil3.5 реле
jqx-14fccz6aac12nil5 реле
jqx-14fccz6aac240.83.5 реле
jqx-14fccz6aac240.85 реле
jqx-14fccz6aac241.23.5 реле
jqx-14fccz6aac241.25 реле
jqx-14fccz6aac2413.5 реле
jqx-14fccz6aac2415 реле
jqx-14fccz6aac24nil3.5 реле
jqx-14fccz6aac24nil5 реле
jqx-14fccz6aac60.83.5 реле
jqx-14fccz6aac60.85 реле
jqx-14fccz6aac61.23.5 реле
jqx-14fccz6aac61.25 реле
jqx-14fccz6aac613.5 реле
jqx-14fccz6aac615 реле
jqx-14fccz6aac6nil3.5 реле
jqx-14fccz6aac6nil5 реле
jqx-14fccz6adc120.83.5 реле
jqx-14fccz6adc120.85 реле
jqx-14fccz6adc121.23.5 реле
jqx-14fccz6adc121.25 реле

jqx-14fccz6adc1213.5 реле
jqx-14fccz6adc1215 реле
jqx-14fccz6adc12nil3.5 реле
jqx-14fccz6adc12nil5 реле
jqx-14fccz6adc240.83.5 реле
jqx-14fccz6adc240.85 реле
jqx-14fccz6adc241.23.5 реле
jqx-14fccz6adc241.25 реле
jqx-14fccz6adc2413.5 реле
jqx-14fccz6adc2415 реле
jqx-14fccz6adc24nil3.5 реле
jqx-14fccz6adc24nil5 реле
jqx-14fccz6adc60.83.5 реле
jqx-14fccz6adc60.85 реле
jqx-14fccz6adc61.23.5 реле
jqx-14fccz6adc61.25 реле
jqx-14fccz6adc613.5 реле
jqx-14fccz6adc615 реле
jqx-14fccz6adc6nil3.5 реле
jqx-14fccz6adc6nil5 реле
jqx-14fc_07 реле
jqx-14ff реле
jqx-14ff/012-1zw hongfa, dip 2010
jqx-14ff/121h реле
jqx-14ff/121hs реле
jqx-14ff/121z реле
jqx-14ff/121zs реле
jqx-14ff/181h реле

jqx-14ff/181hs реле
jqx-14ff/181z реле
jqx-14ff/181zs реле
jqx-14ff/241h реле
jqx-14ff/241hs реле
jqx-14ff/241z реле
jqx-14ff/241zs реле
jqx-14ff/31h реле
jqx-14ff/31hs реле
jqx-14ff/31z реле
jqx-14ff/31zs реле
jqx-14ff/481h реле
jqx-14ff/481hs реле
jqx-14ff/481z реле
jqx-14ff/481zs реле
jqx-14ff/51h реле
jqx-14ff/51hs реле
jqx-14ff/51z реле
jqx-14ff/51zs реле
jqx-14ff/601h реле
jqx-14ff/601hs реле
jqx-14ff/601z реле
jqx-14ff/601zs реле
jqx-14ff/61h реле
jqx-14ff/61hs реле
jqx-14ff/61z реле
jqx-14ff/61zs реле
jqx-14ff/91h реле

jqx-14ff/91hs реле
jqx-14ff/91z реле
jqx-14ff/91zs реле
jqx-14ff121hnil etc1 [list of unclassified manufacturers], single-pole, 10a, borad termina
jqx-14ff121hqc etc1 [list of unclassified manufacturers], single-pole, 10a, borad termina
jqx-14ff121hs etc1 [list of unclassified manufacturers], single-pole, 10a, borad termina
jqx-14ff121znil etc1 [list of unclassified manufacturers], single-pole, 10a, borad termina
jqx-14ff121zqc etc1 [list of unclassified manufacturers], single-pole, 10a, borad termina
jqx-14ff121zs etc1 [list of unclassified manufacturers], single-pole, 10a, borad termina
jqx-14ff181hnil etc1 [list of unclassified manufacturers], single-pole, 10a, borad termina
jqx-14ff181hqc etc1 [list of unclassified manufacturers], single-pole, 10a, borad termina
jqx-14ff181hs etc1 [list of unclassified manufacturers], single-pole, 10a, borad termina
jqx-14ff181znil etc1 [list of unclassified manufacturers], single-pole, 10a, borad termina
jqx-14ff181zqc etc1 [list of unclassified manufacturers], single-pole, 10a, borad termina
jqx-14ff181zs etc1 [list of unclassified manufacturers], single-pole, 10a, borad termina
jqx-14ff241hnil etc1 [list of unclassified manufacturers], single-pole, 10a, borad termina
jqx-14ff241hqc etc1 [list of unclassified manufacturers], single-pole, 10a, borad termina
jqx-14ff241hs etc1 [list of unclassified manufacturers], single-pole, 10a, borad termina
jqx-14ff241znil etc1 [list of unclassified manufacturers], single-pole, 10a, borad termina
jqx-14ff241zqc etc1 [list of unclassified manufacturers], single-pole, 10a, borad termina
jqx-14ff241zs etc1 [list of unclassified manufacturers], single-pole, 10a, borad termina
jqx-14ff31hnil etc1 [list of unclassified manufacturers], single-pole, 10a, borad termina
jqx-14ff31hqc etc1 [list of unclassified manufacturers], single-pole, 10a, borad termina
jqx-14ff31hs etc1 [list of unclassified manufacturers], single-pole, 10a, borad termina
jqx-14ff31znil etc1 [list of unclassified manufacturers], single-pole, 10a, borad termina
jqx-14ff31zqc etc1 [list of unclassified manufacturers], single-pole, 10a, borad termina
jqx-14ff31zs etc1 [list of unclassified manufacturers], single-pole, 10a, borad termina
jqx-14ff481hnil etc1 [list of unclassified manufacturers], single-pole, 10a, borad termina

jqx-14ff481hqc etc1 [list of unclassified manufacturers], single-pole, 10a, borad termina
jqx-14ff481hs etc1 [list of unclassified manufacturers], single-pole, 10a, borad termina
jqx-14ff481znil etc1 [list of unclassified manufacturers], single-pole, 10a, borad termina
jqx-14ff481zqc etc1 [list of unclassified manufacturers], single-pole, 10a, borad termina
jqx-14ff481zs etc1 [list of unclassified manufacturers], single-pole, 10a, borad termina
jqx-14ff51hnil etc1 [list of unclassified manufacturers], single-pole, 10a, borad termina
jqx-14ff51hqc etc1 [list of unclassified manufacturers], single-pole, 10a, borad termina
jqx-14ff51hs etc1 [list of unclassified manufacturers], single-pole, 10a, borad termina
jqx-14ff51znil etc1 [list of unclassified manufacturers], single-pole, 10a, borad termina
jqx-14ff51zqc etc1 [list of unclassified manufacturers], single-pole, 10a, borad termina
jqx-14ff51zs etc1 [list of unclassified manufacturers], single-pole, 10a, borad termina
jqx-14ff601hnil etc1 [list of unclassified manufacturers], single-pole, 10a, borad termina
jqx-14ff601hqc etc1 [list of unclassified manufacturers], single-pole, 10a, borad termina
jqx-14ff601hs etc1 [list of unclassified manufacturers], single-pole, 10a, borad termina
jqx-14ff601znil etc1 [list of unclassified manufacturers], single-pole, 10a, borad termina
jqx-14ff601zqc etc1 [list of unclassified manufacturers], single-pole, 10a, borad termina
jqx-14ff601zs etc1 [list of unclassified manufacturers], single-pole, 10a, borad termina
jqx-14ff61hnil etc1 [list of unclassified manufacturers], single-pole, 10a, borad termina
jqx-14ff61hqc etc1 [list of unclassified manufacturers], single-pole, 10a, borad termina
jqx-14ff61hs etc1 [list of unclassified manufacturers], single-pole, 10a, borad termina
jqx-14ff61znil etc1 [list of unclassified manufacturers], single-pole, 10a, borad termina
jqx-14ff61zqc etc1 [list of unclassified manufacturers], single-pole, 10a, borad termina
jqx-14ff61zs etc1 [list of unclassified manufacturers], single-pole, 10a, borad termina
jqx-14ff91hnil etc1 [list of unclassified manufacturers], single-pole, 10a, borad termina
jqx-14ff91hqc etc1 [list of unclassified manufacturers], single-pole, 10a, borad termina
jqx-14ff91hs etc1 [list of unclassified manufacturers], single-pole, 10a, borad termina
jqx-14ff91znil etc1 [list of unclassified manufacturers], single-pole, 10a, borad termina
jqx-14ff91zqc etc1 [list of unclassified manufacturers], single-pole, 10a, borad termina

jqx-14ff91zs etc1 [list of unclassified manufacturers], single-pole, 10a, board terminals

jqx-14fl-1c-12vdc -, количество в упаковке: 10 шт

jqx-14fw etc1 [list of unclassified manufacturers], single-pole, 20a, board

jqx-14fw12dnlnil etc1 [list of unclassified manufacturers], single-pole, 20a, board

jqx-14fw12dnlp etc1 [list of unclassified manufacturers], single-pole, 20a, board

jqx-14fw12dsnil etc1 [list of unclassified manufacturers], single-pole, 20a, board

jqx-14fw12dsp etc1 [list of unclassified manufacturers], single-pole, 20a, board

jqx-14fw12hlnlnil etc1 [list of unclassified manufacturers], single-pole, 20a, board

jqx-14fw12hlnlp etc1 [list of unclassified manufacturers], single-pole, 20a, board

jqx-14fw12hsnil etc1 [list of unclassified manufacturers], single-pole, 20a, board

jqx-14fw12hsp etc1 [list of unclassified manufacturers], single-pole, 20a, board

jqx-14fw12znlnil etc1 [list of unclassified manufacturers], single-pole, 20a, board

jqx-14fw12znlp etc1 [list of unclassified manufacturers], single-pole, 20a, board

jqx-14fw12zsnil etc1 [list of unclassified manufacturers], single-pole, 20a, board

jqx-14fw12zsp etc1 [list of unclassified manufacturers], single-pole, 20a, board

jqx-14fw18dnlnil etc1 [list of unclassified manufacturers], single-pole, 20a, board

jqx-14fw18dnlp etc1 [list of unclassified manufacturers], single-pole, 20a, board

jqx-14fw18dsnil etc1 [list of unclassified manufacturers], single-pole, 20a, board

jqx-14fw18dsp etc1 [list of unclassified manufacturers], single-pole, 20a, board

jqx-14fw18hlnlnil etc1 [list of unclassified manufacturers], single-pole, 20a, board

jqx-14fw18hlnlp etc1 [list of unclassified manufacturers], single-pole, 20a, board

jqx-14fw18hsnil etc1 [list of unclassified manufacturers], single-pole, 20a, board

jqx-14fw18hsp etc1 [list of unclassified manufacturers], single-pole, 20a, board

jqx-14fw18znlnil etc1 [list of unclassified manufacturers], single-pole, 20a, board

jqx-14fw18znlp etc1 [list of unclassified manufacturers], single-pole, 20a, board

jqx-14fw18zsnil etc1 [list of unclassified manufacturers], single-pole, 20a, board

jqx-14fw18zsp etc1 [list of unclassified manufacturers], single-pole, 20a, board

jqx-14fw24dnlnil etc1 [list of unclassified manufacturers], single-pole, 20a, board

jqx-14fw24dnilp etc1 [list of unclassified manufacturers], single-pole, 20a, boar
jqx-14fw24dsnil etc1 [list of unclassified manufacturers], single-pole, 20a, boar
jqx-14fw24dsp etc1 [list of unclassified manufacturers], single-pole, 20a, boar
jqx-14fw24hnilnil etc1 [list of unclassified manufacturers], single-pole, 20a, boar
jqx-14fw24hnilp etc1 [list of unclassified manufacturers], single-pole, 20a, boar
jqx-14fw24hsnil etc1 [list of unclassified manufacturers], single-pole, 20a, boar
jqx-14fw24hsp etc1 [list of unclassified manufacturers], single-pole, 20a, boar
jqx-14fw24znlnil etc1 [list of unclassified manufacturers], single-pole, 20a, boar
jqx-14fw24znlp etc1 [list of unclassified manufacturers], single-pole, 20a, boar
jqx-14fw24zsnil etc1 [list of unclassified manufacturers], single-pole, 20a, boar
jqx-14fw24zsp etc1 [list of unclassified manufacturers], single-pole, 20a, boar
jqx-14fw48dnlnil etc1 [list of unclassified manufacturers], single-pole, 20a, boar
jqx-14fw48dnlp etc1 [list of unclassified manufacturers], single-pole, 20a, boar
jqx-14fw48dsnil etc1 [list of unclassified manufacturers], single-pole, 20a, boar
jqx-14fw48dsp etc1 [list of unclassified manufacturers], single-pole, 20a, boar
jqx-14fw48hnilnil etc1 [list of unclassified manufacturers], single-pole, 20a, boar
jqx-14fw48hnilp etc1 [list of unclassified manufacturers], single-pole, 20a, boar
jqx-14fw48hsnil etc1 [list of unclassified manufacturers], single-pole, 20a, boar
jqx-14fw48hsp etc1 [list of unclassified manufacturers], single-pole, 20a, boar
jqx-14fw48znlnil etc1 [list of unclassified manufacturers], single-pole, 20a, boar
jqx-14fw48znlp etc1 [list of unclassified manufacturers], single-pole, 20a, boar
jqx-14fw48zsnil etc1 [list of unclassified manufacturers], single-pole, 20a, boar
jqx-14fw48zsp etc1 [list of unclassified manufacturers], single-pole, 20a, boar
jqx-14fw5dnlnil etc1 [list of unclassified manufacturers], single-pole, 20a, boar
jqx-14fw5dnlp etc1 [list of unclassified manufacturers], single-pole, 20a, boar
jqx-14fw5dsnil etc1 [list of unclassified manufacturers], single-pole, 20a, boar
jqx-14fw5dsp etc1 [list of unclassified manufacturers], single-pole, 20a, boar
jqx-14fw5hnilnil etc1 [list of unclassified manufacturers], single-pole, 20a, boar

jqx-14fw5hnilp etc1 [list of unclassified manufacturers], single-pole, 20a, boar
jqx-14fw5hsnil etc1 [list of unclassified manufacturers], single-pole, 20a, boar
jqx-14fw5hsp etc1 [list of unclassified manufacturers], single-pole, 20a, boar
jqx-14fw5znlnil etc1 [list of unclassified manufacturers], single-pole, 20a, boar
jqx-14fw5znlp etc1 [list of unclassified manufacturers], single-pole, 20a, boar
jqx-14fw5zsnil etc1 [list of unclassified manufacturers], single-pole, 20a, boar
jqx-14fw5zsp etc1 [list of unclassified manufacturers], single-pole, 20a, boar
jqx-14fw60dnlnil etc1 [list of unclassified manufacturers], single-pole, 20a, boar
jqx-14fw60dnlp etc1 [list of unclassified manufacturers], single-pole, 20a, boar
jqx-14fw60dsnlnil etc1 [list of unclassified manufacturers], single-pole, 20a, boar
jqx-14fw60dsp etc1 [list of unclassified manufacturers], single-pole, 20a, boar
jqx-14fw60hlnlnil etc1 [list of unclassified manufacturers], single-pole, 20a, boar
jqx-14fw60hlnlp etc1 [list of unclassified manufacturers], single-pole, 20a, boar
jqx-14fw60hsnlnil etc1 [list of unclassified manufacturers], single-pole, 20a, boar
jqx-14fw60hsp etc1 [list of unclassified manufacturers], single-pole, 20a, boar
jqx-14fw60znlnil etc1 [list of unclassified manufacturers], single-pole, 20a, boar
jqx-14fw60znlp etc1 [list of unclassified manufacturers], single-pole, 20a, boar
jqx-14fw60zsnlnil etc1 [list of unclassified manufacturers], single-pole, 20a, boar
jqx-14fw60zsp etc1 [list of unclassified manufacturers], single-pole, 20a, boar
jqx-14fw60dnlnlnil etc1 [list of unclassified manufacturers], single-pole, 20a, boar
jqx-14fw60dnlnlp etc1 [list of unclassified manufacturers], single-pole, 20a, boar
jqx-14fw60dsnlnlnil etc1 [list of unclassified manufacturers], single-pole, 20a, boar
jqx-14fw60dsp etc1 [list of unclassified manufacturers], single-pole, 20a, boar
jqx-14fw60hlnlnlnil etc1 [list of unclassified manufacturers], single-pole, 20a, boar
jqx-14fw60hlnlnlp etc1 [list of unclassified manufacturers], single-pole, 20a, boar
jqx-14fw60hsnlnlnil etc1 [list of unclassified manufacturers], single-pole, 20a, boar
jqx-14fw60hsp etc1 [list of unclassified manufacturers], single-pole, 20a, boar
jqx-14fw60znlnlnlnil etc1 [list of unclassified manufacturers], single-pole, 20a, boar

jqx-14fw6zniip etc1 [list of unclassified manufacturers], single-pole, 20a, boar
jqx-14fw6zsnil etc1 [list of unclassified manufacturers], single-pole, 20a, boar
jqx-14fw6zsp etc1 [list of unclassified manufacturers], single-pole, 20a, boar
jqx-14fw9dniinil etc1 [list of unclassified manufacturers], single-pole, 20a, boar
jqx-14fw9dniip etc1 [list of unclassified manufacturers], single-pole, 20a, boar
jqx-14fw9dsnil etc1 [list of unclassified manufacturers], single-pole, 20a, boar
jqx-14fw9dsp etc1 [list of unclassified manufacturers], single-pole, 20a, boar
jqx-14fw9hniinil etc1 [list of unclassified manufacturers], single-pole, 20a, boar
jqx-14fw9hniip etc1 [list of unclassified manufacturers], single-pole, 20a, boar
jqx-14fw9hsnil etc1 [list of unclassified manufacturers], single-pole, 20a, boar
jqx-14fw9hsp etc1 [list of unclassified manufacturers], single-pole, 20a, boar
jqx-14fw9zniinil etc1 [list of unclassified manufacturers], single-pole, 20a, boar
jqx-14fw9zniip etc1 [list of unclassified manufacturers], single-pole, 20a, boar
jqx-14fw9zsnil etc1 [list of unclassified manufacturers], single-pole, 20a, boar
jqx-14fw9zsp etc1 [list of unclassified manufacturers], single-pole, 20a, boar
jqx-15f
jqx-15f-24vdc-c hwe, группа: реле, описание: 277vac / 28vdc, 20a, 30a, габариты: 32x27x20мм
jqx-15f-l-12v жи°екћ, dip 2010
jqx-15f-l-dc12v жи°екћ, dip 2010
jqx-29f-1c-12vdc wanjia electric
jqx-29f-1c-12vdc
jqx-29f-1c-24vdc wanjia electric
jqx-30f-1c-12vdc wanjia electric
jqx-30f-2c-12vdc группа: реле, описание: тип контактов: 2с; икатушки: 12в; ікомм: 30а,
габариты: 38x36x48мм
jqx-30f-2c-220vac
jqx-37f реле
jqx-37f0051h реле
jqx-37f0051ht реле

jqx-37f0061h реле
jqx-37f0061ht реле
jqx-37f0091h реле
jqx-37f0091ht реле
jqx-37f0121h реле
jqx-37f0121ht реле
jqx-37f0241h реле
jqx-37f0241ht реле
jqx-37f0481h реле
jqx-37f0481ht реле
jqx-37f0601h реле
jqx-37f0601ht реле
jqx-38fa-12v
jqx-40f-2z-ac220v
jqx-52f-1c-220vac wanjia electric
jqx-54fe реле
jqx-54fe/12h3nil реле
jqx-54fe/12h3t реле
jqx-54fe/24h3nil реле
jqx-54fe/24h3t реле
jqx-54fe/48h3nil реле
jqx-54fe/48h3t реле
jqx-54fe/5h3nil реле
jqx-54fe/5h3t реле
jqx-54fe/6h3nil реле
jqx-54fe/6h3t реле
jqx-54feaz20bdc12vc dblectro [db lectro inc], compact high capacity relay for inductive load, rushing current 70a and steady-state current 20a

jqx-54feaz20bdc24vc dblectro [db lectro inc], compact high capacity relay for inductive load, rushing current 70a and steady-state current 20a

jqx-54feaz20bdc48vc dblectro [db lectro inc], compact high capacity relay for inductive load, rushing current 70a and steady-state current 20a

jqx-54feaz20bdc6vc dblectro [db lectro inc], compact high capacity relay for inductive load, rushing current 70a and steady-state current 20a

jqx-54feaz20bdc9vc dblectro [db lectro inc], compact high capacity relay for inductive load, rushing current 70a and steady-state current 20a

jqx-54feaz250bdc12vc dblectro [db lectro inc], compact high capacity relay for inductive load, rushing current 70a and steady-state current 20a

jqx-54feaz250bdc24vc dblectro [db lectro inc], compact high capacity relay for inductive load, rushing current 70a and steady-state current 20a

jqx-54feaz250bdc48vc dblectro [db lectro inc], compact high capacity relay for inductive load, rushing current 70a and steady-state current 20a

jqx-54feaz250bdc6vc dblectro [db lectro inc], compact high capacity relay for inductive load, rushing current 70a and steady-state current 20a

jqx-54feaz250bdc9vc dblectro [db lectro inc], compact high capacity relay for inductive load, rushing current 70a and steady-state current 20a

jqx-54feaz25bdc12vc dblectro [db lectro inc], compact high capacity relay for inductive load, rushing current 70a and steady-state current 20a

jqx-54feaz25bdc24vc dblectro [db lectro inc], compact high capacity relay for inductive load, rushing current 70a and steady-state current 20a

jqx-54feaz25bdc48vc dblectro [db lectro inc], compact high capacity relay for inductive load, rushing current 70a and steady-state current 20a

jqx-54feaz25bdc6vc dblectro [db lectro inc], compact high capacity relay for inductive load, rushing current 70a and steady-state current 20a

jqx-54feaz25bdc9vc dblectro [db lectro inc], compact high capacity relay for inductive load, rushing current 70a and steady-state current 20a

jqx-54feaz277bdc12vc dblectro [db lectro inc], compact high capacity relay for inductive load, rushing current 70a and steady-state current 20a

jqx-54feaz277bdc24vc dblectro [db lectro inc], compact high capacity relay for inductive load, rushing current 70a and steady-state current 20a

jqx-54feaz277bdc48vc dblectro [db lectro inc], compact high capacity relay for inductive load, rushing current 70a and steady-state current 20a

jqx-54feaz277bdc6vc dblectro [db lectro inc], compact high capacity relay for inductive load, rushing current 70a and steady-state current 20a

jqx-54feaz277bdc9vc dblectro [db lectro inc], compact high capacity relay for inductive load, rushing current 70a and steady-state current 20a

jqx-54w реле

jqx-54wa20dc110vcb реле

jqx-54wa20dc110vcf реле

jqx-54wa20dc12vcb реле

jqx-54wa20dc12vcf реле

jqx-54wa20dc24vcb реле

jqx-54wa20dc24vcf реле

jqx-54wa20dc48vcb реле

jqx-54wa20dc48vcf реле

jqx-54wa20dc5vcb реле

jqx-54wa20dc5vcf реле

jqx-54wa20dc6vcb реле

jqx-54wa20dc6vcf реле

jqx-54wa20dc9vcb реле

jqx-54wa20dc9vcf реле

jqx-54wa250dc110vcb реле

jqx-54wa250dc110vcf реле

jqx-54wa250dc12vcb реле

jqx-54wa250dc12vcf реле

jqx-54wa250dc24vcb реле

jqx-54wa250dc24vcf реле

jqx-54wa250dc48vcb реле

jqx-54wa250dc48vcf реле

jqx-54wa250dc5vcb реле

jqx-54wa250dc5vcf реле

jqx-54wa250dc6vcb	реле
jqx-54wa250dc6vcf	реле
jqx-54wa250dc9vcb	реле
jqx-54wa250dc9vcf	реле
jqx-54wa25dc110vcb	реле
jqx-54wa25dc110vcf	реле
jqx-54wa25dc12vcb	реле
jqx-54wa25dc12vcf	реле
jqx-54wa25dc24vcb	реле
jqx-54wa25dc24vcf	реле
jqx-54wa25dc48vcb	реле
jqx-54wa25dc48vcf	реле
jqx-54wa25dc5vcb	реле
jqx-54wa25dc5vcf	реле
jqx-54wa25dc6vcb	реле
jqx-54wa25dc6vcf	реле
jqx-54wa25dc9vcb	реле
jqx-54wa25dc9vcf	реле
jqx-54wa277dc110vcb	реле
jqx-54wa277dc110vcf	реле
jqx-54wa277dc12vcb	реле
jqx-54wa277dc12vcf	реле
jqx-54wa277dc24vcb	реле
jqx-54wa277dc24vcf	реле
jqx-54wa277dc48vcb	реле
jqx-54wa277dc48vcf	реле
jqx-54wa277dc5vcb	реле
jqx-54wa277dc5vcf	реле

jqx-54wa277dc6vcb	реле
jqx-54wa277dc6vcf	реле
jqx-54wa277dc9vcb	реле
jqx-54wa277dc9vcf	реле
jqx-58f-1c-12vdc pbf	wanjia electric
jqx-59f-1z-80a-220vac	wanjia electric
jqx-62-1c-12vdc	wanjia electric
jqx-62-1c-12vdc pbf	wanjia electric
jqx-62f	реле
jqx-62f-2c-12vdc	wanjia electric
jqx-62f/0051hf	реле
jqx-62f/0051hnil	реле
jqx-62f/0061hf	реле
jqx-62f/0061hnil	реле
jqx-62f/0091hf	реле
jqx-62f/0091hnil	реле
jqx-62f/0121hf	реле
jqx-62f/0121hnil	реле
jqx-62f/0181hf	реле
jqx-62f/0181hnil	реле
jqx-62f/0241hf	реле
jqx-62f/0241hnil	реле
jqx-62f/0481hf	реле
jqx-62f/0481hnil	реле
jqx-62faz16cdc12v	реле
jqx-62faz16cdc18v	реле
jqx-62faz16cdc24v	реле
jqx-62faz16cdc48v	реле

jqx-62faz16cdc5v	реле
jqx-62faz16cdc6v	реле
jqx-62faz16cdc9v	реле
jqx-62faz16dc12v	реле
jqx-62faz16dc18v	реле
jqx-62faz16dc24v	реле
jqx-62faz16dc48v	реле
jqx-62faz16dc5v	реле
jqx-62faz16dc6v	реле
jqx-62faz16dc9v	реле
jqx-62faz20cdc12v	реле
jqx-62faz20cdc18v	реле
jqx-62faz20cdc24v	реле
jqx-62faz20cdc48v	реле
jqx-62faz20cdc5v	реле
jqx-62faz20cdc6v	реле
jqx-62faz20cdc9v	реле
jqx-62faz20dc12v	реле
jqx-62faz20dc18v	реле
jqx-62faz20dc24v	реле
jqx-62faz20dc48v	реле
jqx-62faz20dc5v	реле
jqx-62faz20dc6v	реле
jqx-62faz20dc9v	реле
jqx-68	реле
jqx-68f	реле
jqx-68f-006-1hs-551	glenair
jqx-68f-012-1zs-551	glenair

jqx-68f-012-1zsb-555 glenair

jqx-68f-024-1zs hongfa, dip 2010

jqx-68f-024-1zs-551 glenair

jqx-68f-024-1zsb-555 glenair

jqx-68f-12v-1zs hongfa, dip 2011

jqx-68f-12vdc-1zs hongfa, dip 2011

jqx-68f-1zs-12v hongfa, dip 2011

jqx-68f-1zs-12vdc hongfa, dip 2011

jqx-68f-1zs-24v hongfa, dip 2011

jqx-68f-1zs-24vdc hongfa, dip 2011

jqx-68f-24v-1zs hongfa, dip 2011

jqx-68f-24vdc-1zs hongfa, dip 2011

jqx115-f etc1 [list of unclassified manufacturers], 16a pole board typ

jqx115-f-i etc1 [list of unclassified manufacturers], 16a pole board typ

jqx115f0121hs3 glenair

jqx115f024-2zs4 hongfa relay, jqx115f024-2zs4 miniature electromagnetic relays

jqx115f110vdc

jqx13f-1c-a-dc24v-1 группа: реле, описание: тип контактов:1с; катушки:24b; икомм: 20а

jqx13f-2c-a-dc12v-1 группа: реле, описание: тип контактов:2с; катушки:12b; икомм:10а

jqx14-ff etc1 [list of unclassified manufacturers], single-pole, 10а, borad termina

s-8354a38mc-jqxt2g seiko semiconductors, регуляторы напряжения - импульсные регуляторы step-up swr pwm 18.7ua iq

wj175-3z socket [jqx-38fa] wanjia electric