

Реле HONGFA, купить в Минске tel. +375447584780  
www.fotorele.net www.tiristor.by радиодетали, электронные компоненты  
email minsk17@tut.by tel.+375 29 758 47 80 МТС

Реле HONGFA, аналог, замена, Минск, каталог, описание, технические, характеристики,  
datasheet, параметры, маркировка, габариты, фото,

QR код



# CONTENTS

## Industrial Relay ..... 36

HF13F .....	36
HF18FF .....	36
HF18FA .....	36

HF10FH .....	37
HF10FF .....	37

## Safety Relay ..... 38

HFA2 .....	38
HFA4 .....	38

HFA6 .....	38
HF3701 .....	39

## Latching Relay ..... 40

HFE7 .....	40
HFE20 .....	40
HFE39 .....	40
HFE27 .....	41
HFE26 .....	41
HFE10 .....	41
HFE9 .....	42
HFE19-60 .....	42
HFE19-60(391) .....	42
HFE19-80(391) .....	43
HFE42 .....	43
HFE19-90 .....	43
HFE22 .....	44

HFE37 .....	44
HFE28 .....	44
HFE29 .....	45
HFE12 .....	45
HFE21 .....	45
HFE31 .....	46
HFE25 .....	46
HFE6 .....	46
HFE17 .....	47
HFE35 .....	47
HFE36 .....	47
HFE23 .....	48

## Automotive Relay & Module ..... 49

HFKM .....	49
HFKD .....	49
HFKDV .....	49
HFKC/HFKC-T .....	50
HFKA/HFKA-T .....	50
HFKW/HFKW-SH .....	50
HFKT/HFKT-T .....	51
HFKP .....	51
HF3FF-M .....	51
HFKE .....	52
HFV6 .....	52
HFV6-G .....	52
HFV15 .....	53
HFV4 .....	53
HFV4-SH .....	53
HFV4N .....	54

HFV7A .....	54
HFV16 .....	54
HFV7 .....	55
HFV11 .....	55
HFV9 .....	55
HFV9-G .....	56
HFV28 .....	56
HFV12 .....	56
HF3501 .....	57
HF3506/HF3506A .....	57
HF3508 .....	57
HF3505/HF3505A .....	57
HF3504 .....	58
HF3507 .....	58
HF3503 .....	58
HF3605 .....	58



HONGFA RELAY

ISO9001, ISO/TS16949, ISO14001, OHSAS18001, IECQ QC 080000 CERTIFIED

# CONTENTS

## Hermetically Sealed Relay ----- 59

HF9110 -----	59	HF9515 -----	68
HF9111 -----	59	HF9516 -----	68
HF9112 -----	59	HF9517 -----	68
HF9113 -----	60	HF9518 -----	69
HF9114 -----	60	HF9519 -----	69
HF9116 -----	60	HF9520 -----	69
HF9117 -----	61	HF9521 -----	70
HF9210 -----	61	HF9522 -----	70
HF9211 -----	61	HF9525 -----	70
HF9215 -----	62	HF9526 -----	71
HF9216 -----	62	HF9527 -----	71
HF9217 -----	62	HF9532 -----	71
HF9310 -----	63	HF9533 -----	72
HF9311 -----	63	HF9610 -----	72
HF9312 -----	63	HF9611 -----	72
HF9313 -----	64	HF9612 -----	73
HF9314 -----	64	HF9613 -----	73
HF9316 -----	64	HF9614 -----	73
HF9317 -----	65	HF9615 -----	74
HF9319 -----	65	HF9616 -----	74
HF9320 -----	65	HF9617 -----	74
HF9323 -----	66	HF9618 -----	75
HF9510 -----	66	HF9619 -----	75
HF9511 -----	66	HF9620 -----	75
HF9512 -----	67	HF9621 -----	76
HF9513 -----	67	HF9622 -----	76
HF9514 -----	67	HF9710 -----	76

## Relay Socket ----- 77

49F/49FA Sockets -----	77	10FF Sockets -----	83
41F Sockets -----	77	118F Sockets -----	85
13F Sockets -----	78	14FF Sockets -----	86
18FF Sockets -----	79		



HONGFA RELAY

ISO9001, ISO/TS16949, ISO14001, OHSAS18001, IECQ QC 080000 CERTIFIED

# SIGNAL & POWER RELAY SELECTION GUIDE

Terminals			Coil		Relay Type	Contact Form	Page	Switching Current [A]										
PCB	QC	Plug-in/Other	DC	AC				0	5	10	15	20	25	30	40	60	80	100
					HF49FD	1A (SPST-NO)	15											
					HF46F		15											
					HF32FA		16											
					HF32FA-T		17											
					HF41F		15											
					HF46F-G		16											
					HF32FA-G		17											
					HF32F		17											
					HF32F-G		18											
					HF33F		18											
					HF36F		18											
					HF36FD		19											
					HF162F		19											
					HF8		19											
					HF3FA		20											
					HF3FD		20											
					HF3FF		20											
					HF7FF		21											
					HFE7		40											
					HF118F		23											
					HF115F-H		25											
					HF141FF		27											
					HF14FF		27											
					HF12FF		22											
					HF21FF		21											
					HF7FD		21											
					HF7520		23											
					HF115F		24											
					HF115F-A		24											
					HF115F-T/TH		24											
					HF115F-S		26											
					HF115F-L		26											
					HF158F		27											
					HF62F		29											
					HF84F		35											
					HF94F		35											
					HF152F		22											
					HF152FD		22											
					HF115F-Q		25											
					HF14FW		28											
					HF25F		28											
					HF102F		29											
					HF161F		29											
					HF160F	30												
					HF161F-W	30												
					HF37F	30												
					HF105F-1	31												
					HF105F-2	31												
					HF105F-4	31												
					HF105F-5	32												
					HF2100	32												
					HF2110/HF2120	32												
					HF2150	33												

**How to use the table:** Please select the CONTACT FORM. Then choose the relay according to SWITCHING CURRENT and OTHERS (for instance, coil voltage, terminal style, etc.).

# SIGNAL & POWER RELAY SELECTION GUIDE

Terminals		Coil		Relay Type	Contact Form	Page	Switching Current	[A]
PCB	QC Plug-in/Other	DC	AC				0 5 10 15 20 25 30 40 60 80 100 200	
				HF2160	1A (SPST-NO)	33		
				HF116F-1		33		
				HF116F-2		34		
				HF116F-3		34		
				HF115F-I		25		
				HF42F	2A	16		
				HF118F		23		
				HFE7		40		
				HF115F		24		
				HF115F-A		24		
				HF140FF		28		
				HF116F-1		33		
				HF116F-2		34		
				HF116F-3		34		
				HF92F		34		
				HFD23	1C (SPDT)	12		
				HF32FA		16		
				HF32F		17		
				HFD41/HFD41A		12		
				HF41F		15		
				HF84F		35		
				HF33F		18		
				HF36F		18		
				HF8		19		
				HF3FA		20		
				HF3FD		20		
				HF3FF		20		
				HF7FF		21		
				HF21FF		21		
				HF7520		23		
				HF118F		23		
				HF115F-H		25		
				HF141FF		27		
				HF14FF		27		
				HF7FD		21		
				HF152F		22		
				HF115F		24		
				HF115F-A		24		
				HF115F-T/TH		24		
				HF115F-L		26		
				HF115FP		26		
				HF158F		27		
				HF152FD		22		
				HF94F		35		
				HF14FW		28		
HF105F-1	31							
HF105F-2	31							
HF105F-4	31							
HF105F-5	32							

**How to use the table:** Please select the CONTACT FORM. Then choose the relay according to SWITCHING CURRENT and OTHERS (for instance, coil voltage, terminal style, etc.).

# SIGNAL & POWER RELAY SELECTION GUIDE

Terminals		Coil		Relay Type	Contact Form	Page	Switching Current	[A]										
PCB	QC	Plug-in	Other	DC	AC		0	5	10	15	20	25	30	40	60	80	100	200
■	■			■		HF2100	1C (SPDT)	32	[Bar chart showing switching current up to 20A]									
■	■			■		HF2110/HF2120		32	[Bar chart showing switching current up to 20A]									
■	■			■		HF2150		33	[Bar chart showing switching current up to 20A]									
■	■			■		HF2160		33	[Bar chart showing switching current up to 20A]									
■	■			■		HF115F-I		25	80A Inrush current									
■	■			■		HFD31	2C	13	[Bar chart showing switching current up to 5A]									
■	■			■		HFD27		12	[Bar chart showing switching current up to 5A]									
■	■			■		HFD3		13	[Bar chart showing switching current up to 5A]									
■	■			■		HFD4		14	[Bar chart showing switching current up to 5A]									
■	■			■		HFD2		13	[Bar chart showing switching current up to 5A]									
■	■			■		HF118F		23	[Bar chart showing switching current up to 5A]									
■	■			■		HF115F		24	[Bar chart showing switching current up to 5A]									
■	■			■		HF115F-A		24	[Bar chart showing switching current up to 5A]									
■	■			■		HF115FP		26	[Bar chart showing switching current up to 5A]									
■	■			■		HF140FF		28	[Bar chart showing switching current up to 5A]									
■	■			■		HF92F		34	[Bar chart showing switching current up to 30A]									
■	■			■		HFE7		1B (SPST-NC)	40	[Bar chart showing switching current up to 10A]								
■	■			■		HF118F	23		[Bar chart showing switching current up to 10A]									
■	■			■		HF115F-H	25		[Bar chart showing switching current up to 10A]									
■	■			■		HF141FF	27		[Bar chart showing switching current up to 10A]									
■	■			■		HF21FF	21		[Bar chart showing switching current up to 15A]									
■	■			■		HF105F-1	31		[Bar chart showing switching current up to 15A]									
■	■			■		HF105F-2	31		[Bar chart showing switching current up to 15A]									
■	■			■		HF105F-4	31		[Bar chart showing switching current up to 15A]									
■	■			■		HF105F-5	32		[Bar chart showing switching current up to 15A]									
■	■			■		HF2100	32		[Bar chart showing switching current up to 15A]									
■	■			■		HF2110/HF2120	32		[Bar chart showing switching current up to 15A]									
■	■			■		HF2150	33		[Bar chart showing switching current up to 15A]									
■	■			■		HF2160	33		[Bar chart showing switching current up to 15A]									
■	■			■		HF115F	24		[Bar chart showing switching current up to 15A]									
■	■			■		HF115F-A	24		[Bar chart showing switching current up to 15A]									
■	■			■		HF84F	35		[Bar chart showing switching current up to 15A]									
■	■			■		HF94F	35		[Bar chart showing switching current up to 15A]									
■	■			■		HF115F-Q	25		[Bar chart showing switching current up to 20A]									
■	■			■		HF14FW	28	[Bar chart showing switching current up to 20A]										
■	■			■		HF8565	35	[Bar chart showing switching current up to 40A]										
■	■			■		HF118F	2B	23	[Bar chart showing switching current up to 5A]									
■	■			■		HFE7		40	[Bar chart showing switching current up to 5A]									
■	■			■		HF115F		24	[Bar chart showing switching current up to 5A]									
■	■			■		HF115F-A		24	[Bar chart showing switching current up to 5A]									
■	■			■		HFE7	1A+1B	40	[Bar chart showing switching current up to 10A]									
■	■			■		HF94F		35	[Bar chart showing switching current up to 15A]									

**How to use the table:** Please select the CONTACT FORM. Then choose the relay according to SWITCHING CURRENT and OTHERS (for instance, coil voltage, terminal style, etc.).

# INDUSTRIAL & SAFETY RELAY SELECTION GUIDE

Terminal				Coil		Relay Type	Contact Page	Switching Current (Res. load)											[A]								
PCB	QC	Plug-in	Other	DC	AC		Form	0	5	10	15	20	25	30	40	60	80	100	200								
						HF49FD	1A (SPST-NO)	15																			
						HF41F		15																			
						HF118F		23																			
						HF141FF		27																			
						HF14FF		27																			
						HF13F		36																			
						HF115F		24																			
						HF115F-A		24																			
						HF118F	1B (SPST-NC)	23																			
						HF141FF		27																			
						HF115F		24																			
						HF115F-A		24																			
						HF14FW		28																			
												HF41F	1C (SPDT)	15													
												HF118F		23													
												HF141FF		27													
HF14FF	27																										
HF13F	36																										
HF115F	24																										
HF115F-A	24																										
HF115FP	26																										
						HF118F	2A (DPST-NO)	23																			
						HF3701		39																			
						HF115F		24																			
						HF115F-A		24																			
						HF13F		36																			
						HF140FF		28																			
												HF118F	2B	23													
												HF115F		24													
HF115F-A	24																										
						HF118F	2C (DPDT)	23																			
						HFA2		38																			
						HF18FF		36																			
						HF115F		24																			
						HF115F-A		24																			
						HF115FP		26																			
						HF140FF		28																			
						HF18FA		36																			
						HF10FH		37																			
						HF10FF		37																			
						HF13F		36																			

How to use the table: Please select the CONTACT FORM. Then choose the relay according to SWITCHING CURRENT and OTHERS (for instance, coil voltage, terminal style, etc.).

# INDUSTRIAL & SAFETY RELAY SELECTION GUIDE

Terminal		Coil		Relay Type	Contact Form	Page	Switching Current (Res. load)											[A]			
PCB	QC	Plug-in	Other	DC	AC			0	5	10	15	20	25	30	40	60	80	100	200		
■	■	■	■	—	■	HFA2	2C (DPDT)	38	5												
■	■	■	■	—	■	HF18FF		36	5												
■	■	■	■	—	■	HF115FP		26	5												
■	■	■	■	—	■	HF140FF		28	5												
■	■	■	■	—	■	HF18FA		36	5												
■	■	■	■	—	■	HF10FH		37	5												
■	■	■	■	—	■	HF10FF		37	5												
■	■	■	■	—	■	HF13F		36	5												
■	■	■	■	—	■	HF18FF		3C	36	5											
■	■	■	■	—	■	HF10FH	37		5												
■	■	■	■	—	■	HF10FF	37		5												
■	■	■	■	—	■	HF3701	4A	39	5												
■	■	■	■	—	■	HF18FF	4C	36	5												
■	■	■	■	—	■	HF18FA		36	5												
■	■	■	■	—	■	HFA2	1NO+1NC	38	5												
■	■	■	■	—	■	HF3701		39	5												
■	■	■	■	—	■	HFA4	2NO+2NC	38	5												
■	■	■	■	—	■	HFA4	3NO+1NC	38	5												
■	■	■	■	—	■	HF3701		39	5												
■	■	■	■	—	■	HFA6	3NO+3NC	38	5												
■	■	■	■	—	■	HFA6	4NO+2NC	38	5												
■	■	■	■	—	■	HFA6	5NO+1NC	38	5												

**How to use the table:** Please select the CONTACT FORM. Then choose the relay according to SWITCHING CURRENT and OTHERS (for instance, coil voltage, terminal style, etc.).



# LATCHING RELAY SELECTION GUIDE

Terminals				Coil		Relay Type	Contact Form	Page	Switching Current	[A]
PCB	QC	Plug-in	Other	DC	AC					
■				—	■	HFE7	1A(SH)/1B(SD)(SPST-NO/SPST-NC)	40	10	
■				—	■	HFE20		40	15	
■				—	■	HFE27		41	20	
■	■			—	■	HFE26		41	30	
■				—	■	HFE10		41	40	
	■			—	■	HFE9		42	60	
	■			—	■	HFE19-60		42	60	
	■			—	■	HFE19-60(391)		42	60	
	■			—	■	HFE19-80(391)		43	80	
	■			—	■	HFE42		43	90	
	■			—	■	HFE19-90		43	90	
	■			—	■	HFE22		44	100	
	■			—	■	HFE29		45	110	
	■			—	■	HFE12		45	110	
	■			—	■	HFE21		45	110	
	■			—	■	HFE31		46	200	
■				—	■	HFE20	1C	40	15	
■				—	■	HFE27		41	20	
■	■			—	■	HFE26		41	20	
■				—	■	HFE10		41	40	
■				—	■	HFE7	1A+1B	40	10	
■				—	■	HFE39		40	15	
■				—	■	HFE7	2A(2SH)/2B(2SD)	40	10	
■				—	■	HFE39		40	15	
	■			—	■	HFE37		44	100	
	■			—	■	HFE28		44	100	
	■			—	■	HFE25		46	200	
	■			—	■	HFE6		46	200	
	■			—	■	HFE17		47	200	
	■			—	■			47	200	
	■			—	■	HFE35	3A(3SH)/3B(3SD)	47	100	
	■			—	■	HFE36		47	100	
	■			—	■	HFE23		48	110	

**How to use the table:** Please select the CONTACT FORM. Then choose the relay according to SWITCHING CURRENT and OTHERS (for instance, coil voltage, terminal style, etc.).

# AUTOMOTIVE RELAY SELECTION GUIDE

Terminals			Coil		Relay Type	Contact Form	Page	Switching Current (Res. load)											[A]	
PCB	QC	Plug-In	Other	DC	AC			0	5	10	15	20	25	30	40	60	100	200		
						HFKM	1A (SPST-NO)	49	[Bar chart showing switching current for 1A (SPST-NO) relays]											
						HF3FF-M		51	[Bar chart showing switching current for 1A (SPST-NO) relays]											
						HFKC / HFKC-T		50	[Bar chart showing switching current for 1A (SPST-NO) relays]											
						HFKE		52	[Bar chart showing switching current for 1A (SPST-NO) relays]											
						HFV11		55	[Bar chart showing switching current for 1A (SPST-NO) relays]											
						HFV9		55	[Bar chart showing switching current for 1A (SPST-NO) relays]											
						HFKW		50	[Bar chart showing switching current for 1A (SPST-NO) relays]											
						HFV6		52	[Bar chart showing switching current for 1A (SPST-NO) relays]											
						HFV9-G		56	[Bar chart showing switching current for 1A (SPST-NO) relays]											
						HFV28		56	[Bar chart showing switching current for 1A (SPST-NO) relays]											
						HFV6-G		52	[Bar chart showing switching current for 1A (SPST-NO) relays]											
						HFKT / HFKT-T		51	[Bar chart showing switching current for 1A (SPST-NO) relays]											
						HFV15		53	[Bar chart showing switching current for 1A (SPST-NO) relays]											
						HFV4		53	[Bar chart showing switching current for 1A (SPST-NO) relays]											
						HFV4N		54	[Bar chart showing switching current for 1A (SPST-NO) relays]											
						HFKP		51	[Bar chart showing switching current for 1A (SPST-NO) relays]											
						HFV7A		54	[Bar chart showing switching current for 1A (SPST-NO) relays]											
						HFV16	54	[Bar chart showing switching current for 1A (SPST-NO) relays]												
						HFV7	55	[Bar chart showing switching current for 1A (SPST-NO) relays]												
						HFV12	56	[Bar chart showing switching current for 1A (SPST-NO) relays]												
						HFKM	1C (SPDT)	49	[Bar chart showing switching current for 1C (SPDT) relays]											
						HF3FF-M		51	[Bar chart showing switching current for 1C (SPDT) relays]											
						HFKE		52	[Bar chart showing switching current for 1C (SPDT) relays]											
						HFKD		49	[Bar chart showing switching current for 1C (SPDT) relays]											
						HFKC / HFKC-T		50	[Bar chart showing switching current for 1C (SPDT) relays]											
						HFV6		52	[Bar chart showing switching current for 1C (SPDT) relays]											
						HFV9		55	[Bar chart showing switching current for 1C (SPDT) relays]											
						HFKA / HFKA-T <sup>(1)</sup>		50	[Bar chart showing switching current for 1C (SPDT) relays]											
						HFKW		50	[Bar chart showing switching current for 1C (SPDT) relays]											
						HFV9-G		56	[Bar chart showing switching current for 1C (SPDT) relays]											
						HFV28		56	[Bar chart showing switching current for 1C (SPDT) relays]											
						HFV6-G		52	[Bar chart showing switching current for 1C (SPDT) relays]											
						HFV15		53	[Bar chart showing switching current for 1C (SPDT) relays]											
						HFV4		53	[Bar chart showing switching current for 1C (SPDT) relays]											
						HFKP	51	[Bar chart showing switching current for 1C (SPDT) relays]												
						HFV7A	54	[Bar chart showing switching current for 1C (SPDT) relays]												
						HFKC/HFKC-T	2A	50	[Bar chart showing switching current for 2A relays]											
						HFKD	2C	49	[Bar chart showing switching current for 2C relays]											
						HFKDV		49	[Bar chart showing switching current for 2C relays]											
						HFKC/HFKC-T		50	[Bar chart showing switching current for 2C relays]											
						HFKA/HFKA-T <sup>(1)</sup>		50	[Bar chart showing switching current for 2C relays]											

1) The switching current of HFKA / HFKA-T refers to motor locked load.



**How to use the table:** Please select the CONTACT FORM. Then choose the relay according to SWITCHING CURRENT and OTHERS (for instance, coil voltage, terminal style, etc.).

# AUTOMOTIVE RELAY SELECTION GUIDE

Terminals			Coil		Relay Type	Contact Form	Page	Switching Current (Res. load)										[A]	
PCB	QC	Plug-in	Other	DC				AC	0	5	10	15	20	25	30	40	60		100
<input checked="" type="checkbox"/>	<input type="checkbox"/>	<input type="checkbox"/>	<input type="checkbox"/>	<input checked="" type="checkbox"/>	<input type="checkbox"/>	HFKM	1B	49											
<input checked="" type="checkbox"/>	<input type="checkbox"/>	<input type="checkbox"/>	<input type="checkbox"/>	<input checked="" type="checkbox"/>	<input type="checkbox"/>	HFKM (1V)	1U/1V/1W	49											
<input checked="" type="checkbox"/>	<input type="checkbox"/>	<input type="checkbox"/>	<input type="checkbox"/>	<input checked="" type="checkbox"/>	<input type="checkbox"/>	HFKW-SH		50											
<input checked="" type="checkbox"/>	<input type="checkbox"/>	<input type="checkbox"/>	<input type="checkbox"/>	<input checked="" type="checkbox"/>	<input type="checkbox"/>	HFKM (1U)		49											
<input checked="" type="checkbox"/>	<input type="checkbox"/>	<input type="checkbox"/>	<input type="checkbox"/>	<input checked="" type="checkbox"/>	<input type="checkbox"/>	HFKM (1W)		49											
<input type="checkbox"/>	<input checked="" type="checkbox"/>	<input type="checkbox"/>	<input type="checkbox"/>	<input checked="" type="checkbox"/>	<input type="checkbox"/>	HFV4-SH		53											

**How to use the table:** Please select the CONTACT FORM. Then choose the relay according to SWITCHING CURRENT and OTHERS (for instance, coil voltage, terminal style, etc.).

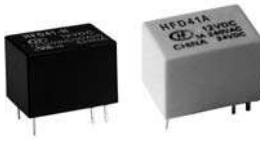
## SIGNAL RELAY SELECTION CHART

Type	HFD23	HFD41/HFD41A	HFD27
Appearance			
Dimensions(L x W x H) mm	12.5 x 7.5 x 10.0	15.7 x 11.0 x 12.0	20.2 x 10.0 x 11.5
Features	<ul style="list-style-type: none"> <li>• Max.2A switching capability</li> <li>• High sensitive: 150mW</li> <li>• 1 Form C configuration</li> <li>• Plastic sealed type available</li> </ul>	<ul style="list-style-type: none"> <li>• 5A switching capability</li> <li>• 1 Form C configuration</li> <li>• Standard PCB layout</li> <li>• Plastic sealed and flux proofed types available</li> </ul>	<ul style="list-style-type: none"> <li>• High switching capacity: 125VA/60W</li> <li>• Matching 16 pin IC socket</li> <li>• Epoxy plastic sealed for automatic wave soldering and cleaning</li> <li>• Bifurcated contacts</li> </ul>

### Contact Ratings

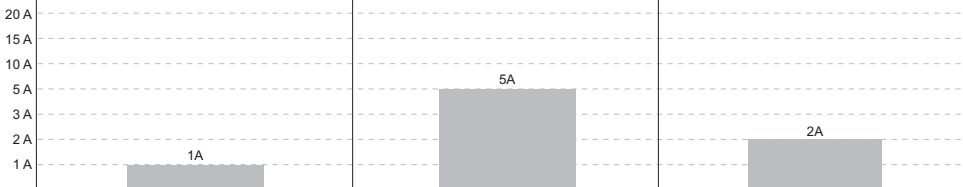
Contact Form	1C	1C	2C
Contact Material	AgNi +Au plated	AgNi, AgCdO	AgNi + Au plated
Max. Rated Switching Current (Resistive load)			
	20A		
	15A		
	10A		
	5A		
3A			
2A			
1A			
Max. Switching Voltage	125VAC / 60VDC	240VAC / 30VDC	240VAC / 120VDC
Max. Switching Power	62.5VA / 30W	600VA / 30W	125VA / 60W
Rated Load (Resistive load)	0.5A 125VAC 1A 30VDC	1A 120VAC, 1A 125VAC/30VDC 1A 240VAC/30VDC 2A 125VAC, 3A 120VAC 2A 120VAC, 5A 120VAC	1A 125VAC 2A 30VDC

### Coil Ratings

Rated Voltage	1.5VDC to 24VDC	3VDC to 24VDC	3VDC to 48VDC
Nominal Operating Power	0.15W, 0.2W	0.2W, 0.36W, 0.45W	0.15W to 0.58W

### Specifications

Insulation Resistance	1000MΩ	100MΩ	1000MΩ
Dielectric Strength (Between coil and contacts)	1000VAC	1000VAC	1500VAC
Ambient Temperature	-30°C to 70°C	-25°C to 70°C	-40°C to 85°C
Operate / Release Time max.	5ms / 5ms	10ms / 5ms	7ms / 4ms
Mechanical Endurance min.	1 x 10 <sup>7</sup> OPS	1 x 10 <sup>7</sup> OPS	1 x 10 <sup>8</sup> OPS
Electrical Endurance min.	1 x 10 <sup>5</sup> OPS(1A 30VDC)	1 x 10 <sup>5</sup> OPS	1 x 10 <sup>5</sup> OPS (at 2A 30VDC)

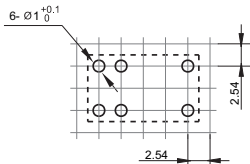
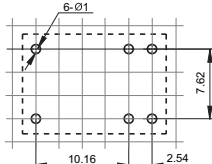
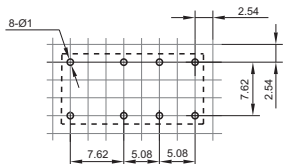
Layout (Bottom view)			
Terminal Type	PCB (DIP)	PCB (DIP)	PCB (DIP)
Approved Standards	UL/CUL CQC	UL/CUL CQC	UL/CUL TÜV CQC
File No.	E133481 CQC09002035070	E133481 CQC10002049171	E133481 R50075362 CQC09002033393
Cross Reference	OMRON: G5V-1 PANASONIC: HY FUJITSU: SY NEC: TY TE: V23111	OMRON: G2E FUJITSU: FBR211SC/MZ FBR211SE/MZ AXICOM: V23101 OEG: OUA/OUAZ	OMRON: G5V-2 PANASONIC: DS2Y FUJITSU: FBR244/FTR-C2/RY NEC: MR62 AXICOM: V23105/D2N

Note: Specification and dimensions in this catalog are subject to change without notice.

## SIGNAL RELAY SELECTION CHART

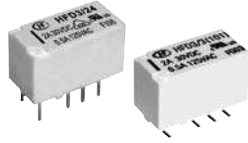
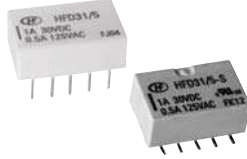
Type	HFD2	HFD3	HFD31
Appearance			
Dimensions(L x W x H) mm	20.2 x 10.2 x 10.6	15.0 x 7.5 x 9.0	14.0 x 9.0 x 5.0
Features	<ul style="list-style-type: none"> <li>• High sensitive: 150mW</li> <li>• High switching capacity: 90W/125VA</li> <li>• Epoxy plastic sealed for automatic wave soldering and cleaning</li> <li>• Matching standard 16 pin IC socket</li> <li>• Bifurcated contacts</li> <li>• Single side stable and latching types available</li> </ul>	<ul style="list-style-type: none"> <li>• Meets EN60950/EN41003</li> <li>• Surge voltage up to 2500VAC, meets FCC Part 68 and Telecordia</li> <li>• 2.5kV dielectric strength (between coil and contacts)</li> <li>• Bifurcated contacts</li> <li>• Single side stable and latching types available</li> </ul>	<ul style="list-style-type: none"> <li>• Surge voltage up to 1500VAC, meets FCC Part 68 and Telecordia</li> <li>• High contact capacity :1A 30VDC</li> <li>• Single side stable and latching types available</li> </ul>

### Contact Ratings

Contact Form	2C	2C	2C
Contact Material	Ag-AuAg8, AgPd60	AgNi + Au plated	Silver alloy + Au plated
Max. Rated Switching Current (Resistive load)	20 A		
	15 A		
	10 A		
	5 A		
	3 A	3A	2A
2 A			
1 A			
Max. Switching Voltage	250VAC / 220VDC	250VAC / 220VDC	125VAC / 110VDC
Max. Switching Power	125VA / 90W	62.5VA / 60W	62.5VA / 30W
Rated Load (Resistive load)	1A 125VAC 2A 30VDC 3A 30VDC	0.5A 125VAC 2A 30VDC	0.5A 125VAC 1A 30VDC

### Coil Ratings

Rated Voltage	3VDC to 48VDC	1.5VDC to 48VDC	1.5VDC to 24VDC
Nominal Operating Power	0.075W, 0.1W, 0.15W, 0.2W	0.1W, 0.14W, 0.2W	0.1W, 0.14W, 0.2W

### Specifications

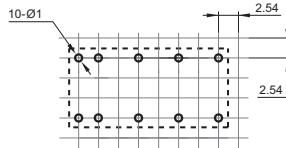
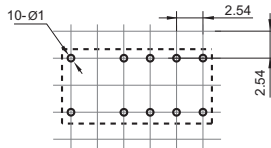
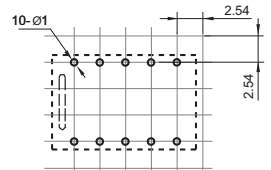
Insulation Resistance	1000MΩ	1000MΩ	1000MΩ
Dielectric Strength (Between coil and contacts)	1500VAC (1 coil)	2000VAC	1000VAC
Ambient Temperature	-40°C to 85°C	-40°C to 85°C	-40°C to 70°C
Operate / Release Time max.	4.5ms / 3.5ms	4ms / 4ms	3ms / 3ms
Mechanical Endurance min.	1 x 10 <sup>8</sup> OPS	1 x 10 <sup>8</sup> OPS	1 x 10 <sup>8</sup> OPS
Electrical Endurance min.	5 x 10 <sup>5</sup> OPS (at 1A 30VDC)	5 x 10 <sup>5</sup> OPS (at 1A 30VDC)	1 x 10 <sup>5</sup> OPS (at 0.5A 125VAC) 2 x 10 <sup>5</sup> OPS (at 1A 30VDC)
Layout (Bottom view)			
Terminal Type	PCB (DIP)	PCB (DIP, SMT)	PCB (DIP, SMT)
Approved Standards	UL/CUL	UL/CUL VDE	UL/CUL
File No.	E133481	E133481 40018867	E133481
Cross Reference	OMRON: G6A PANASONIC: DS2Y FUJITSU: RA NEC: MR82 TE: V23042 / AXICOM: MT2	OMRON: G6S PANASONIC: TX FUJITSU: NA/BA NEC: EC2/ED2 AXICOM: P2/V23079	OMRON: G6H PANASONIC: TQ FUJITSU: A NEC: EA2 AXICOM: FP2

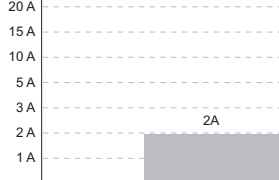
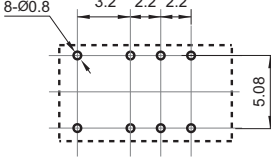

Note: Specification and dimensions in this catalog are subject to change without notice.

## SIGNAL RELAY SELECTION CHART



Type	HFD4		
Appearance			
Dimensions(L x W x H) mm	10.0 x 6.5 x 5.4		
Features	<ul style="list-style-type: none"> <li>• Offers excellent board space savings</li> <li>• Surge withstand voltage up to 2500V, meets FCC Part 68 and Telecordia</li> <li>• Meets EN60950/EN41003</li> <li>• SMT and DIP types available</li> <li>• Single side stable and latching type available</li> </ul>		
<b>Contact Ratings</b>			
Contact Form	2C		
Contact Material	Silver alloy + Au plated		
Max. Rated Switching Current (Resistive load)			
Max. Switching Voltage	250VAC / 220VDC		
Max. Switching Power	62.5VA / 60W		
Rated Load (Resistive load)	0.5A 125VAC 2A 30VDC		
<b>Coil Ratings</b>			
Rated Voltage	1.5VDC to 24VDC		
Nominal Operating Power	0.1W, 0.14W, 0.2W		
<b>Specifications</b>			
Insulation Resistance	1000MΩ		
Dielectric Strength (Between coil and contacts)	1600VAC		
Ambient Temperature	-40°C to 85°C		
Operate / Release Time max.	3ms / 3ms		
Mechanical Endurance min.	1 x 10 <sup>6</sup> OPS		
Electrical Endurance min.	1 x 10 <sup>5</sup> OPS		
Layout (Bottom view)			
Terminal Type	PCB (DIP, SMT)		
Approved Standards	UL/CUL		
File No.	E133481		
Cross Reference	OMRON: G6K PANASONIC: AGQ AXICOM: IM		

Note: Specification and dimensions in this catalog are subject to change without notice.

## POWER RELAY SELECTION CHART

Type	HF49FD	HF41F	HF46F
Appearance			
Dimensions(L x W x H) mm	20.0 x 5.0 x 12.5	28.0 x 5.0 x 15.0	20.5 x 7.2 x 15.3
Features	<ul style="list-style-type: none"> <li>• 5A switching capability</li> <li>• 3kV dielectric strength (between coil and contacts)</li> <li>• Surge voltage up to 4kV (between coil and contacts)</li> <li>• Slim size (width 5mm, height 12.5mm)</li> <li>• High sensitive: 120mW</li> </ul>	<ul style="list-style-type: none"> <li>• Slim size (width 5mm)</li> <li>• 4kV dielectric strength (between coil and contacts)</li> <li>• Surge voltage up to 6kV (between coil and contacts)</li> <li>• High sensitive: 170mW</li> </ul>	<ul style="list-style-type: none"> <li>• 5A switching capability</li> <li>• 10kV impulse withstand voltage (between coil and contacts)</li> <li>• Highly efficient magnetic circuit for high sensitivity: 200mW</li> <li>• Extremely small footprint utilizing PCB area</li> </ul>

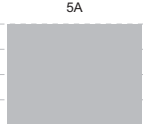
### Contact Ratings

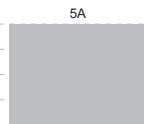
Contact Form	1A	1A, 1C	1A
Contact Material	AgSnO <sub>2</sub> , AgNi	AgSnO <sub>2</sub> , AgNi	AgSnO <sub>2</sub> , AgNi
Max. Rated Switching Current (Resistive load)			
Max. Switching Voltage	250VAC / 30VDC	400VAC / 125VDC	277VAC / 30VDC
Max. Switching Power	1250VA / 150W	1500VA / 180W	1385VA / 150W
Rated Load (Resistive load)	5A 250VAC 5A 30VDC	6A 250VAC 6A 30VDC	3A 250VAC/30VDC 5A 250VAC/30VDC

### Coil Ratings

Rated Voltage	5VDC to 24VDC	5VDC to 60VDC	3VDC to 24VDC
Nominal Operating Power	0.12W to 0.18W	0.17W (48VDC to 60VDC:0.21W)	0.2W

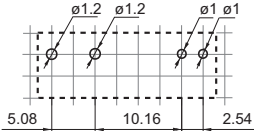
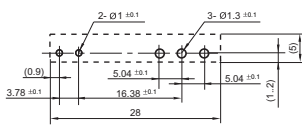
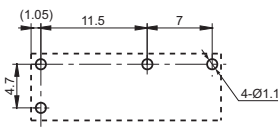

### Specifications

Insulation Resistance	1000MΩ	1000MΩ	1000MΩ
Dielectric Strength (Between coil and contacts)	3000VAC	4000VAC	4000VAC
Ambient Temperature	-40°C to 85°C	-40°C to 85°C	-40°C to 85°C
Operate / Release Time max.	10ms / 5ms	8ms / 4ms	10ms / 10ms
Mechanical Endurance min.	2 x 10 <sup>7</sup> OPS	1 x 10 <sup>7</sup> OPS	5 x 10 <sup>6</sup> OPS
Electrical Endurance min.	1 x 10 <sup>5</sup> OPS(3A 250VAC/30VDC)	6 x 10 <sup>4</sup> OPS(1 Form A, at 85°C)	1.2 x 10 <sup>5</sup> OPS

Layout (Bottom view)			
Terminal Type	PCB	PCB	PCB
Approved Standards	UL/CUL TÜV CQC	UL/CUL VDE CQC	UL/CUL VDE CQC
File No.	E133481 R50149334 CQC10002049162	E133481 40020043 CQC09002035072	E134517 40025215 CQC08001024932
Cross Reference	OMRON: G6DS PANASONIC: PA FUJITSU: RB/NY SCHRACK: PCN	PANASONIC: PE FUJITSU: FTR-LY SCHRACK: V23092/SNR FINDER: 34.51	OMRON: G5NB/G5T PANASONIC: LD FUJITSU: FTR-F3

Note: Specification and dimensions in this catalog are subject to change without notice.

## POWER RELAY SELECTION CHART

Type	HF46F-G	HF42F	HF32FA
Appearance			
Dimensions(L x W x H) mm	20.5 x 7.2 x 15.3	23.6 x 12.0 x 24.8	17.6 x 10.1 x 12.3
Features	<ul style="list-style-type: none"> <li>• 10A switching capability</li> <li>• 10kV impulse withstand voltage (between coil and contacts)</li> <li>• Highly efficient magnetic circuit for high sensitivity: 200mW</li> <li>• Extremely small footprint utilizing PCB area</li> </ul>	<ul style="list-style-type: none"> <li>• 5A switching capability</li> <li>• TV-3 125VAC approved by UL standard</li> <li>• 2 Form A slim configuration</li> <li>• Plastic sealed and flux proofed types available</li> </ul>	<ul style="list-style-type: none"> <li>• 5A switching capability</li> <li>• Creepage/clearance distance&gt;8mm</li> <li>• 5kV dielectric strength (between coil and contacts)</li> <li>• 1 Form A meets VDE 0700/0631</li> <li>• 1 Form C meets VDE 0631</li> </ul>

### Contact Ratings

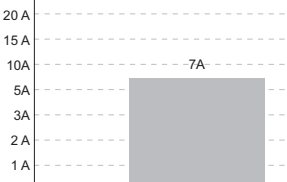
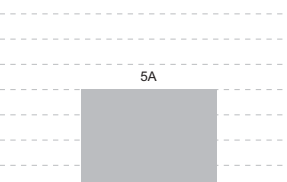
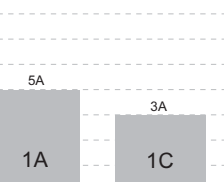
Contact Form	1A	2A	1A, 1C
Contact Material	AgSnO <sub>2</sub> , AgNi	AgSnO <sub>2</sub> , AgCdO	AgNi
Max. Rated Switching Current (Resistive load)			
Max. Switching Voltage	277VAC / 30VDC	250VAC / 30VDC	250VAC / 30VDC
Max. Switching Power	2770VA / 300W	1250VA / 150W	1250VA / 150W
Rated Load (Resistive load)	7A 250VAC/28VDC	5A 250VAC / 30VDC	1A: 5A 250VAC/30VDC 1C: 3A 250VAC/30VDC

### Coil Ratings

Rated Voltage	3VDC to 24VDC	5VDC to 48VDC	3VDC to 48VDC
Nominal Operating Power	0.2W	0.53W	0.2W, 0.45W

### Specifications

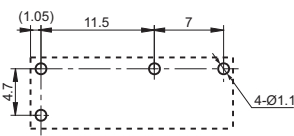
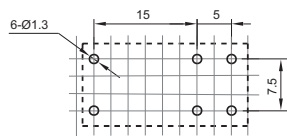
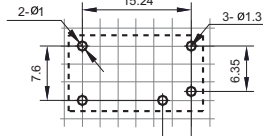

Insulation Resistance	1000MΩ	1000MΩ	1000MΩ
Dielectric Strength (Between coil and contacts)	4000VAC	4000VAC	5000VAC
Ambient Temperature	-40°C to 85°C	-40°C to 70°C	-40°C to 85°C
Operate / Release Time max.	10ms / 10ms	15ms / 10ms	8ms / 4ms
Mechanical Endurance min.	5 x 10 <sup>6</sup> OPS	1 x 10 <sup>7</sup> OPS	1 x 10 <sup>6</sup> OPS
Electrical Endurance min.	6 x 10 <sup>4</sup> OPS	5 x 10 <sup>4</sup> OPS	1 x 10 <sup>5</sup> OPS

Layout (Bottom view)			
Terminal Type	PCB	PCB	PCB
Approved Standards	UL/CUL VDE CQC	UL/CUL TÜV CQC	UL/CUL VDE CQC
File No.	E134517 40025215 CQC08001024932	E133481 R50188744 CQC09002034521	E134517 40006182 CQC09002028689
Cross Reference	OMRON: G5NB/G5T PANASONIC: LD FUJITSU: FTR-F3	OMRON: G5PA-2 PANASONIC: LA FUJITSU: FTR-F4 NEC: CN OEG: OSA/PCI	FUJITSU: JV OEG: OJ/OJE P&B: T77

Note: Specification and dimensions in this catalog are subject to change without notice.



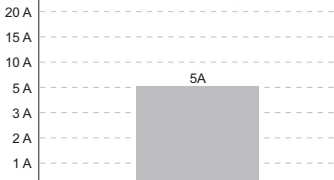
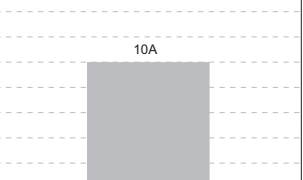
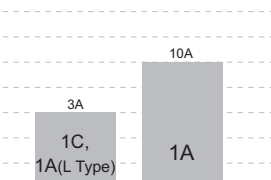
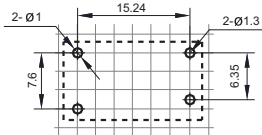
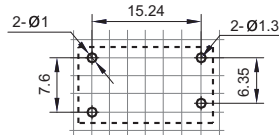
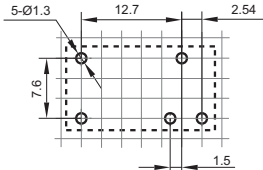

## POWER RELAY SELECTION CHART

Type	HF32FA-T	HF32FA-G	HF32F
Appearance			
Dimensions(L x W x H) mm	17.6 x 10.1 x 12.3	17.6 x 10.1 x 12.3	18.4 x 10.2 x 15.3
Features	<ul style="list-style-type: none"> <li>• High temperature: 105°C</li> <li>• 5A switching capability</li> <li>• Creepage/clearance distance&gt;8mm</li> <li>• 5kV dielectric strength (between coil and contacts)</li> <li>• Meets VDE 0700/0631 reinforce insulation</li> </ul>	<ul style="list-style-type: none"> <li>• 10A switching capability</li> <li>• Creepage/clearance distance&gt;8mm</li> <li>• 5kV dielectric strength (between coil and contacts)</li> <li>• Meets VDE 0700/0631 reinforce insulation</li> </ul>	<ul style="list-style-type: none"> <li>• 10A switching capability</li> <li>• Subminiature standard PCB layout</li> <li>• Plastic sealed and flux proofed types available</li> </ul>
<b>Contact Ratings</b>			
Contact Form	1A	1A	1A, 1C
Contact Material	AgNi	AgSnO <sub>2</sub>	AgNi, AgCdO
Max. Rated Switching Current (Resistive load)			
Max. Switching Voltage	250VAC / 30VDC	250VAC	250VAC / 30VDC
Max. Switching Power	1250VA / 150W	2500VA	1250VA / 150W
Rated Load (Resistive load)	5A 250VAC 5A 30VDC	10A 250VAC	1A: 10A 125VAC 5A 250VAC/30VDC L Type: 3A 250VAC/30VDC LQ Type: 8A 250VAC 1C: 3A 250VAC/30VDC
<b>Coil Ratings</b>			
Rated Voltage	3VDC to 24VDC	3VDC to 48VDC	3VDC to 48VDC
Nominal Operating Power	0.2W	0.23W, 0.45W	0.2W, 0.45W
<b>Specifications</b>			
Insulation Resistance	1000MΩ	1000MΩ	1000MΩ
Dielectric Strength (Between coil and contacts)	5000VAC	5000VAC	2500VAC
Ambient Temperature	-40°C to 105°C	-40°C to 85°C	-40°C to 70°C
Operate / Release Time max.	8ms / 4ms	8ms / 4ms	8ms / 5ms
Mechanical Endurance min.	1 x 10 <sup>6</sup> OPS	1 x 10 <sup>6</sup> OPS	1 x 10 <sup>7</sup> OPS
Electrical Endurance min.	1 x 10 <sup>5</sup> OPS	1 x 10 <sup>4</sup> OPS	1 x 10 <sup>5</sup> OPS
Layout (Bottom view)			
Terminal Type	PCB	PCB	PCB
Approved Standards	UL/CUL VDE CQC	UL/CUL VDE CQC	UL/CUL VDE CQC
File No.	E134517 40006182 CQC09002028689	E134517 40006182 CQC09002028689	E134517 40012204 CQC08002027011
Cross Reference	FUJITSU: JV OEG: OJ/OJE P&B: T77	FUJITSU: JV OEG: OJ/OJE P&B: T77	FUJITSU: JV OEG: OJ/OJE P&B: T77

Note: Specification and dimensions in this catalog are subject to change without notice.

## POWER RELAY SELECTION CHART

Type	HF32F-G	HF33F	HF36F
Appearance			
Dimensions(L x W x H) mm	18.4 x 10.2 x 15.3	20.5 x 10.2 x 15.3	23.8 x 9.5 x 24.5
Features	<ul style="list-style-type: none"> <li>• 10A switching capability</li> <li>• 1 Form A configurations</li> <li>• Subminiature standard PCB layout</li> <li>• Plastic sealed and flux proofed types available</li> </ul>	<ul style="list-style-type: none"> <li>• 10A switching capability</li> <li>• Creepage distance:8mm (both for 1 CO and NO)</li> <li>• Clearance distance:NO type 4.5mm; NC type 4mm</li> <li>• Plastic sealed and flux proofed types available</li> </ul>	<ul style="list-style-type: none"> <li>• 10A switching capability</li> <li>• TV-5 125VAC approved by UL standard (only for 1 Form A)</li> <li>• 1 Form A and 1 Form C configurations</li> <li>• Plastic sealed and flux proofed types available</li> </ul>

### Contact Ratings

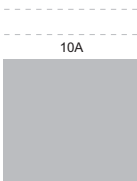
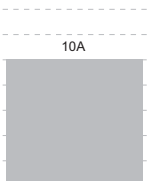
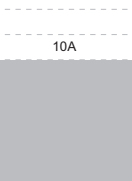
Contact Form	1A	1A, 1C	1A, 1C
Contact Material	AgSnO <sub>2</sub> , AgNi, AgCdO	AgSnO <sub>2</sub> , AgNi, AgCdO	AgSnO <sub>2</sub> , AgCdO
Max. Rated Switching Current (Resistive load)			
Max. Switching Voltage	250VAC / 30VDC	277VAC / 30VDC	250VAC / 30VDC
Max. Switching Power	2500VA / 300W	1250VA / 150W	2500VA / 300W
Rated Load (Resistive load)	10A 250VAC 10A 30VDC	NO: 10A 125VAC 5A 250VAC/30VDC NC: 3A 250VAC/30VDC	10A 250VAC/30VDC TV-5 125VAC

### Coil Ratings

Rated Voltage	3VDC to 48VDC	3VDC to 48VDC	5VDC to 48VDC
Nominal Operating Power	0.45W	0.2W, 0.45W	0.25W, 0.53W

### Specifications

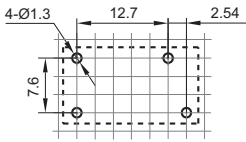
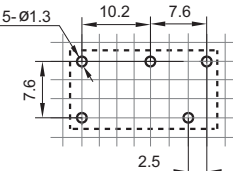
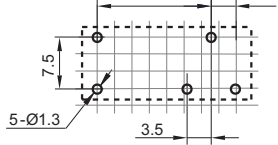

Insulation Resistance	1000MΩ	1000MΩ	1000MΩ
Dielectric Strength (Between coil and contacts)	2500VAC	4000VAC	4000VAC (NO), 3000VAC (NC)
Ambient Temperature	-40°C to 85°C	-40°C to 70°C	-40°C to 70°C
Operate / Release Time max.	8ms / 5ms	8ms / 5ms	15ms / 5ms
Mechanical Endurance min.	1 x 10 <sup>6</sup> OPS	1 x 10 <sup>7</sup> OPS	1 x 10 <sup>7</sup> OPS
Electrical Endurance min.	1 x 10 <sup>5</sup> OPS	1 x 10 <sup>5</sup> OPS	5 x 10 <sup>4</sup> OPS

Layout (Bottom view)			
----------------------	---	--	---

Terminal Type	PCB	PCB	PCB
Approved Standards	UL/CUL VDE CQC	UL/CUL VDE CQC	UL/CUL TÜV CQC
File No.	E134517 40012204 CQC08002027011	E134517 125661 CQC09002028694	E134517 R50156252 CQC09002034525
Cross Reference	FUJITSU: JV OEG: OJ/OJE P&B: T77	OMRON: G5SB/G5Q PANASONIC: JQ/PQ FUJITSU: JY SCHRACK: RE/REL OEG: PCH	OMRON: G5PA-1 PANASONIC: LK FUJITSU: FTR-H2/F2 NEC: CK OEG: SDT

Note: Specification and dimensions in this catalog are subject to change without notice.

## POWER RELAY SELECTION CHART

Type	HF36FD	HF162F	HF8
Appearance			
Dimensions(L x W x H) mm	23.8 x 9.5 x 24.5	26.3 x 26.1 x 10.0	21.3 x 16.2 x 14.4
Features	<ul style="list-style-type: none"> <li>• 10A switching capability</li> <li>• TV-8 125VAC approved by UL standard(118A inrush current)</li> <li>• Ideal for device power reduction</li> <li>• Plastic sealed and flux proofed types available</li> </ul>	<ul style="list-style-type: none"> <li>• High inrush current: TV-8 125VAC (118A inrush current)</li> <li>• Low height, only 9.3mm (excluding buttons)</li> <li>• High sensitivity: 250mW,</li> <li>• Silent type available</li> </ul>	<ul style="list-style-type: none"> <li>• Subminiature, high sensitive, Standard PCB layout</li> <li>• 1 Form A and 1 Form C configurations</li> <li>• Plastic sealed type for automatic wave soldering</li> </ul>

### Contact Ratings

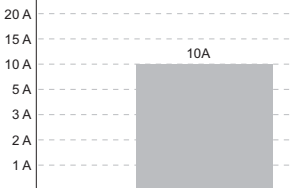
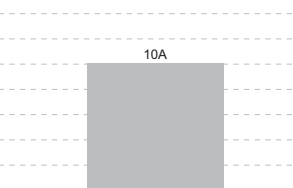
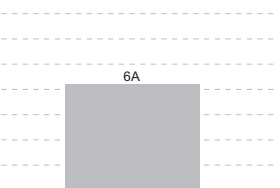
Contact Form	1A	1A	1A, 1C
Contact Material	AgSnO <sub>2</sub>	AgSnO <sub>2</sub>	AgNi
Max. Rated Switching Current (Resistive load)			
Max. Switching Voltage	250VAC / 30VDC	277VAC	300VAC / 30VDC
Max. Switching Power	2500VA / 150W	2216VA	1800VA / 300W
Rated Load (Resistive load)	10A 250VAC 5A 250VAC/30VDC TV-8 125VAC	10A 125VAC 8A/5A 277VAC TV-8 125VAC 3A/100A 250VAC (Capacitive)	HF8: 6A 300VAC/28VDC HF8A: 6A 277VAC/30VDC

### Coil Ratings

Rated Voltage	3VDC to 48VDC	3VDC to 24VDC	3VDC to 48VDC
Nominal Operating Power	0.25W, 0.53W	0.25W	0.33W, 0.45W, 0.6W

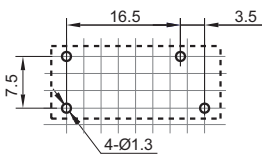
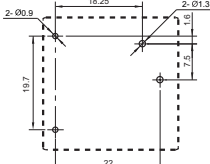
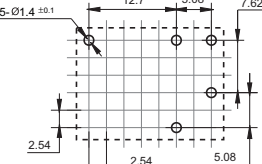

### Specifications

Insulation Resistance	1000MΩ	1000MΩ	100MΩ
Dielectric Strength (Between coil and contacts)	4000VAC	4000VAC	2000VAC
Ambient Temperature	-40°C to 70°C	-40°C to 70°C	-55°C to 90°C
Operate / Release Time max.	15ms / 5ms	15ms / 5ms	6ms / 3ms
Mechanical Endurance min.	1 x 10 <sup>7</sup> ops	1 x 10 <sup>6</sup> ops	1 x 10 <sup>7</sup> ops
Electrical Endurance min.	5 x 10 <sup>4</sup> ops	5 x 10 <sup>4</sup> ops	1 x 10 <sup>5</sup> ops

Layout (Bottom view)			
Terminal Type	PCB	PCB	PCB
Approved Standards	UL/CUL TÜV CQC	UL/CUL VDE CQC	UL/CUL VDE
File No.	E134517 R50183875 CQC10002041724	E133481 40032669 CQC10002050942	E134517 40025189
Cross Reference	OMRON: G5PA-1 PANASONIC: LK NEC: CK OEG: SDT	OMRON: G5PF PANASONIC: LK-F	FUJITSU: LZ P&B: T73 OEG: OUDH

Note: Specification and dimensions in this catalog are subject to change without notice.

## POWER RELAY SELECTION CHART

Type	HF3FA	HF3FD	HF3FF
Appearance			
Dimensions(L x W x H) mm	19.0 x 15.2 x 15.5	19.0 x 15.2 x 15.5	19.0 x 15.2 x 15.5
Features	<ul style="list-style-type: none"> <li>• 15A switching capability</li> <li>• 2.5kV dielectric strength (between coil and contacts)</li> <li>• Flammability class according to UL94, V-0</li> <li>• CTI 250</li> </ul>	<ul style="list-style-type: none"> <li>• 15A switching capability</li> <li>• Subminiature, standard PCB layout</li> <li>• Flammability class according to UL94, V-0</li> <li>• Plastic sealed and flux proofed types available</li> </ul>	<ul style="list-style-type: none"> <li>• 15A switching capability</li> <li>• Subminiature, standard PCB layout</li> <li>• 1 Form A and 1 Form C configurations</li> <li>• Plastic sealed and flux proofed types available</li> </ul>

### Contact Ratings

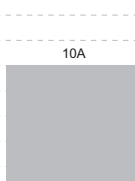
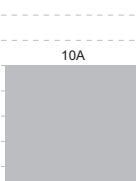
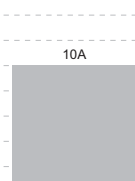
Contact Form	1A, 1C	1A, 1C	1A, 1C
Contact Material	AgSnO <sub>2</sub>	AgSnO <sub>2</sub> , AgNi	AgSnO <sub>2</sub> , AgCdO
Max. Rated Switching Current (Resistive load)			
Max. Switching Voltage	277VAC / 30VDC	277VAC / 30VDC	277VAC / 30VDC
Max. Switching Power	2770VA / 300W	2770VA / 300W	2770VA / 210W
Rated Load (Resistive load)	1A: 10A 250VAC/28VDC 1C: NO: 10A 250VAC/28VDC NO/NC: 5A/5A 250VAC	1A: 10A 250VAC/28VDC 1C: NO: 10A 250VAC/28VDC NO/NC: 7A/3A 250VAC NO/NC: 5A/5A 250VAC	10A 277VAC 10A 28VDC

### Coil Ratings

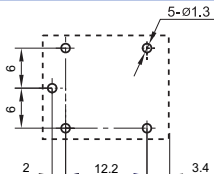
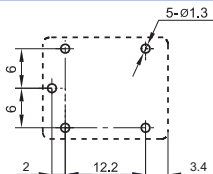
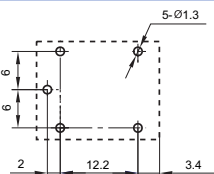

Rated Voltage	3VDC to 48VDC	3VDC to 48VDC	5VDC to 48VDC
Nominal Operating Power	0.36W	0.36W	0.36W (48VDC: 0.51W)

### Specifications

Insulation Resistance	100MΩ	100MΩ	100MΩ
Dielectric Strength (Between coil and contacts)	2500VAC	2000VAC	1500VAC
Ambient Temperature	-40°C to 105°C	-40°C to 105°C	-40°C to 70°C
Operate / Release Time max.	10ms / 5ms	10ms / 5ms	10ms / 5ms
Mechanical Endurance min.	1 x 10 <sup>7</sup> OPS	1 x 10 <sup>7</sup> OPS	1 x 10 <sup>7</sup> OPS
Electrical Endurance min.	1 x 10 <sup>5</sup> OPS (NO, at 8A 250VAC)	1 x 10 <sup>5</sup> OPS (NO, at 7A 250VAC)	1 x 10 <sup>5</sup> OPS (NO, at 7A 250VAC)
Layout (Bottom view)			
Terminal Type	PCB	PCB	PCB
Approved Standards	UL/CUL VDE CQC	UL/CUL VDE CQC	UL/CUL VDE TÜV CQC
File No.	E134517 40023708 CQC08002027860	E134517 40014057 CQC09002034350	E134517 40025218 R50148356 CQC08002027861
Cross Reference	OMRON: G5LA PANASONIC: JS SCHRACK: T7S	OMRON: G5LB PANASONIC: JS SCHRACK: T7S	OMRON: G5LC/G5LE PANASONIC: JS P&B: T72 OEG: PCE/ORWH FINDER: 36.11

Note: Specification and dimensions in this catalog are subject to change without notice.

## POWER RELAY SELECTION CHART

Type	HF7FF	HF7FD	HF21FF
Appearance			
Dimensions(L x W x H) mm	22.5 x 16.5 x 16.5	22.0 x 16.0 x 16.4	20.2 x 16.5 x 20.2
Features	<ul style="list-style-type: none"> <li>• 10A switching capability</li> <li>• Low cost, small package</li> <li>• 1 Form A and 1 Form C configurations</li> <li>• Plastic sealed and flux proofed types available</li> </ul>	<ul style="list-style-type: none"> <li>• 16A switching capability</li> <li>• High performance, Low profile</li> <li>• 2kV dielectric strength (between coil and contacts)</li> <li>• UL94, V-0, CTI250 flammability class</li> </ul>	<ul style="list-style-type: none"> <li>• 15A switching capability</li> <li>• 1 Form A, 1 Form B and 1 Form C configurations</li> <li>• Standard PCB layout</li> <li>• Plastic sealed and flux proofed types available</li> </ul>

### Contact Ratings

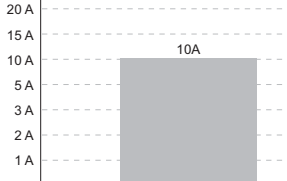
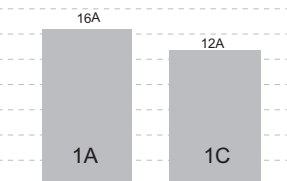
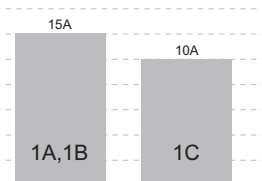
Contact Form	1A, 1C	1A, 1C	1A, 1B, 1C
Contact Material	AgSnO <sub>2</sub> , AgCe	AgSnO <sub>2</sub> , AgCdO	AgSnO <sub>2</sub> , AgCdO
Max. Rated Switching Current (Resistive load)			
Max. Switching Voltage	250VAC / 30VDC	250VAC / 28VDC	250VAC / 30VDC
Max. Switching Power	2400VA / 280W	1A: 4000VA / 280W 1C: 2500VA / 196W	1800VA / 240W
Rated Load (Resistive load)	10A 250VAC/28VDC 5A 250VAC/30VDC	1A: 16A 250VAC 12A 250VAC 10A 250VAC 1C: 12A 125VAC NO/NC:10A/7A 250VAC	1A,1B: 15A 120VAC 1C: 10A 120VAC/24VDC

### Coil Ratings

Rated Voltage	3VDC to 48VDC	3VDC to 48VDC	5VDC to 48VDC
Nominal Operating Power	0.36W (48VDC: 0.51W)	0.36W	0.36W (48VDC: 0.53W)

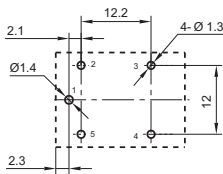
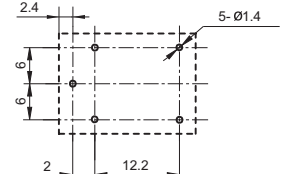
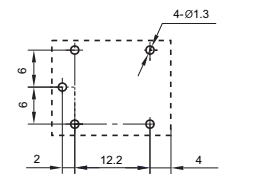

### Specifications

Insulation Resistance	100MΩ	100MΩ	1000MΩ
Dielectric Strength (Between coil and contacts)	1500VAC	2000VAC	1500VAC
Ambient Temperature	-40°C to 70°C	-40°C to 105°C (HF7FD-T)	-40°C to 70°C
Operate / Release Time max.	10ms / 5ms	10ms / 5ms	10ms / 5ms
Mechanical Endurance min.	1 x 10 <sup>7</sup> OPS	1 x 10 <sup>7</sup> OPS	1 x 10 <sup>7</sup> OPS
Electrical Endurance min.	1 x 10 <sup>5</sup> OPS	1 x 10 <sup>5</sup> OPS(1 Form A)	1 x 10 <sup>5</sup> OPS

Layout (Bottom view)			
Terminal Type	PCB	PCB	PCB
Approved Standards	UL/CUL CQC	UL/CUL VDE CQC	UL/CUL
File No.	E134517 CQC09002028260	E134517 40008374 CQC09002037921	E133481
Cross Reference	OMRON: G5LC/G5LE PANASONIC: JSM FUJITSU: CS SCHRACK: T7N OEG: PCE	OMRON: G5LE-VD PANASONIC: JSM FUJITSU: FBR160 NEC: KB SCHRACK: T7N-WG	OMRON: G5L SCHRACK: LN/41896 OEG: SRUDH/SRUUH

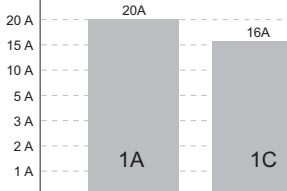
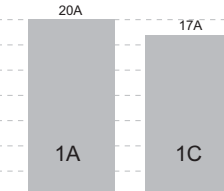
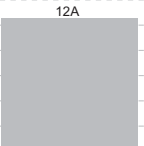
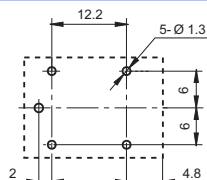
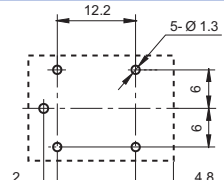
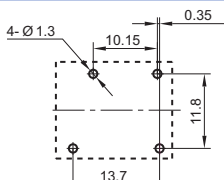

Note: Specification and dimensions in this catalog are subject to change without notice.

## POWER RELAY SELECTION CHART

Type	HF152F	HF152FD	HF12FF
Appearance			
Dimensions(L x W x H) mm	21.0 x 16.0 x 20.6	21.2 x 16.0 x 20.6	18.4 x 15.2 x 10.2
Features	<ul style="list-style-type: none"> <li>• 20A switching capacity</li> <li>• Surge voltage up to 6000VAC (between coil and contacts)</li> <li>• 1 Form C and 1 Form A configurations</li> <li>• Plastic sealed and flux proofed types available</li> </ul>	<ul style="list-style-type: none"> <li>• 20A switching capability</li> <li>• Ambient temperature meets 105°C</li> <li>• High temperature load: 17A 277VAC at 105°C</li> <li>• 1 Form C &amp; 1 Form A configurations available</li> <li>• Product in accordance to EN 60335-1 available</li> </ul>	<ul style="list-style-type: none"> <li>• 12A switching capability</li> <li>• 1 Form A configuration</li> <li>• Subminiature, standard PCB layout</li> <li>• Plastic sealed and flux proofed types available</li> </ul>
<b>Contact Ratings</b>			
Contact Form	1A, 1C	1A, 1C	1A
Contact Material	AgSnO <sub>2</sub> , AgNi	AgSnO <sub>2</sub> , AgNi	AgSnO <sub>2</sub>
Max. Rated Switching Current (Resistive load)			
Max. Switching Voltage	1A: 400VAC / 1C: 400VAC(NO)	400VAC	277VAC
Max. Switching Power	1A: 4700VA / 1C: 4000VA	4700VA	2770VA / 300W
Rated Load (Resistive load)	1A: 20A 125VAC / 17A 277VAC 7A 400VAC 1C: 16A 250VAC NO: 7A 400VAC	1A: 7A 400VAC 17A 277VAC 20A 125VAC 1C: NO: 17A 277VAC NC: 10A 277VAC	12A 125VAC 10A 277VAC/30VDC
<b>Coil Ratings</b>			
Rated Voltage	3VDC to 48VDC	3VDC to 48VDC	3VDC to 24VDC
Nominal Operating Power	0.36W	0.36W	0.45W
<b>Specifications</b>			
Insulation Resistance	100MΩ	1000MΩ	1000MΩ
Dielectric Strength (Between coil and contacts)	2500VAC	2500VAC	2500VAC
Ambient Temperature	-40°C to 105°C (HF152F-T)	-40°C to 105°C	-40°C to 85°C
Operate / Release Time max.	10ms / 5ms	10ms / 5ms	8ms / 5ms
Mechanical Endurance min.	1 x 10 <sup>7</sup> OPS	1 x 10 <sup>7</sup> OPS	1 x 10 <sup>7</sup> OPS
Electrical Endurance min.	1A: 1 x 10 <sup>5</sup> OPS / 1C: 5 x 10 <sup>4</sup> OPS	1A: 1 x 10 <sup>5</sup> OPS / 1C: 5 x 10 <sup>4</sup> OPS	1 x 10 <sup>5</sup> OPS
Layout (Bottom view)			
Terminal Type	PCB	PCB	PCB
Approved Standards	UL/CUL VDE CQC	UL/CUL VDE	UL/CUL CQC
File No.	E134517 40017837 CQC09002034520	E134517 40031203	E134517 CQC09002036155
Cross Reference	OMRON: G5LE-VD PANASONIC: JSM	OMRON: G5LE-VD PANASONIC: JSM SCHRACK: LN-H	SONGCHUAN: 834

Note: Specification and dimensions in this catalog are subject to change without notice.

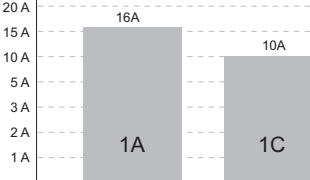
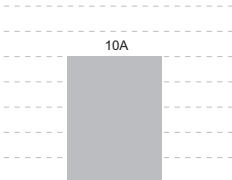
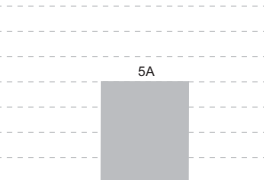
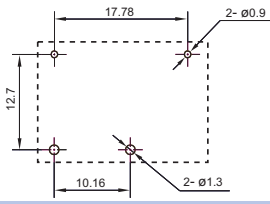
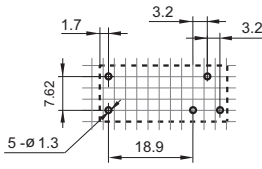
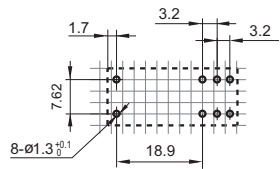

## POWER RELAY SELECTION CHART

Type	HF7520	HF118F 1 pole	HF118F 2 pole
Appearance			
Dimensions(L x W x H) mm	22.0 x 16.0 x 10.5	28.5 x 10.1 x 12.5	28.5 x 10.1 x 12.5
Features	<ul style="list-style-type: none"> <li>• Low height, flat construction</li> <li>• 16A switching capability</li> <li>• High sensitive 200mW</li> <li>• PCB &amp; QC terminals available</li> <li>• Plastic sealed and flux proofed types available (with vent-hole cover)</li> </ul>	<ul style="list-style-type: none"> <li>• 10A switching capability</li> <li>• 5kV dielectric strength (between coil and contacts)</li> <li>• Low height: 12.5 mm</li> <li>• Creepage distance &gt;8mm (VDE0435/0631/0700)</li> <li>• Product in accordance to IEC 60335-1 available</li> </ul>	<ul style="list-style-type: none"> <li>• 5A switching capability</li> <li>• 5kV dielectric strength (between coil and contacts)</li> <li>• Low height: 12.5 mm</li> <li>• Creepage distance &gt;8mm (VDE0435/0631/0700)</li> <li>• Product in accordance to IEC 60335-1 available</li> </ul>
<b>Contact Ratings</b>			
Contact Form	1A   1C	1A, 1B, 1C	2A, 2B, 2C
Contact Material	AgSnO <sub>2</sub> , AgNi, AgCdO	AgSnO <sub>2</sub> , AgNi	AgSnO <sub>2</sub> , AgNi
Max. Rated Switching Current (Resistive load)			
Max. Switching Voltage	250VAC / 30VDC	440VAC / 125VDC	440VAC / 125VDC
Max. Switching Power	4000VA/300W   2500VA/1500VA	2500VA/300W	1250VA/150W
Rated Load (Resistive load)	1A: 16A 250VAC 10A 250VAC/30VDC TV-5 1C: NO/NC:10A/6A 125/250VAC	10A 250VAC 10A 30VDC	5A 250VAC 5A 30VDC
<b>Coil Ratings</b>			
Rated Voltage	5VDC to 48VDC	5VDC to 60VDC	5VDC to 60VDC
Nominal Operating Power	0.2W, 0.4W	0.22W to 0.29W	0.36W
<b>Specifications</b>			
Insulation Resistance	1000MΩ	1000MΩ	1000MΩ
Dielectric Strength (Between coil and contacts)	2500VAC	5000VAC	5000VAC
Ambient Temperature	-40°C to 105°C	-40°C to 85°C	-40°C to 85°C
Operate / Release Time max.	15ms / 5ms	10ms / 5ms	10ms / 5ms
Mechanical Endurance min.	1 x 10 <sup>7</sup> OPS	1 x 10 <sup>7</sup> OPS	1 x 10 <sup>7</sup> OPS
Electrical Endurance min.	5 x 10 <sup>4</sup> OPS	1 x 10 <sup>5</sup> OPS	1 x 10 <sup>5</sup> OPS
Layout (Bottom view)			
Terminal Type	PCB, QC	PCB	PCB
Approved Standards	UL/CUL TÜV CQC	UL/CUL VDE CQC	UL/CUL VDE CQC
File No.	E133481 R50154274 CQC09002034524	E134517 40010480 CQC09002035071	E134517 40010480 CQC09002035071
Cross Reference	OMRON: G5CA PANASONIC: JV/JVN NEC: CQ OEG: PCD	OMRON: G6RN FUJITSU: FTR-F1 SCHRACK: RYII	OMRON: G6RN FUJITSU: FTR-F1 SCHRACK: RYII



Note: Specification and dimensions in this catalog are subject to change without notice.



## POWER RELAY SELECTION CHART

Type	HF115F	HF115F-A	HF115F-T/TH
Appearance			
Dimensions(L x W x H) mm	29.0 x 12.7 x 15.7	29.0 x 12.7 x 15.7	29.0 x 12.7 x 15.7
Features	<ul style="list-style-type: none"> <li>• Low height: 15.7 mm</li> <li>• 16A switching capability</li> <li>• 5kV dielectric strength (between coil and contacts)</li> <li>• Creepage distance: 10mm</li> <li>• Meet VDE0435/0631/0700</li> <li>• Product in accordance to IEC 60335-1 available</li> </ul>	<ul style="list-style-type: none"> <li>• AC coil voltage type</li> <li>• 16A switching capability</li> <li>• 5kV dielectric strength (between coil and contacts)</li> <li>• Creepage distance: 10mm</li> <li>• Meet VDE0700/0631</li> <li>• Product in accordance to IEC 60335-1 available</li> </ul>	<ul style="list-style-type: none"> <li>• High temperature: 105°C</li> <li>• 5kV dielectric strength (between coil and contacts)</li> <li>• Creepage distance: 10mm</li> <li>• Meet VDE0700/0631</li> <li>• Product in accordance to IEC 60335-1 available</li> </ul>

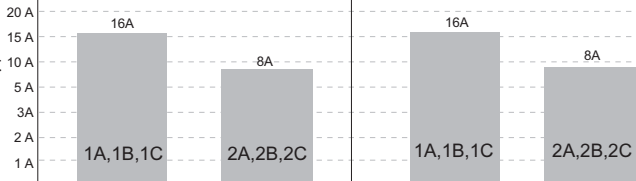
### Contact Ratings

Contact Form	1A, 1B, 1C   2A, 2B, 2C	1A, 1B, 1C   2A, 2B, 2C	1A, 1C
Contact Material	AgSnO <sub>2</sub> , AgNi, AgCdO		AgSnO <sub>2</sub> , AgNi, AgCdO
Max. Rated Switching Current (Resistive load)			
Max. Switching Voltage	440VAC / 300VDC		440VAC / 300VDC
Max. Switching Power	3000VA/4000VA   2000VA	3000VA/4000VA   2000VA	HF115F-T: 4000VA HF115F-TH: 2500VA
Rated Load (Resistive load)	16A 250VAC 12A 250VAC	8A 250VAC	HF115F-T: 16A 250VAC HF115F-TH: 10A 250VAC

### Coil Ratings

Rated Voltage	5VDC to 110VDC	24VAC, 115VAC, 230VAC	5VDC to 60VDC
Nominal Operating Power	0.4W	0.75VA	0.25W, 0.4W

### Specifications

Insulation Resistance	1000MΩ	1000MΩ	1000MΩ
Dielectric Strength (Between coil and contacts)	5000VAC	5000VAC	5000VAC
Ambient Temperature	-40°C to 85°C	-40°C to 70°C	-40°C to 105°C
Operate / Release Time max.	15ms / 8ms		15ms / 8ms
Mechanical Endurance min.	1 x 10 <sup>7</sup> OPS	1 x 10 <sup>6</sup> OPS	1 x 10 <sup>7</sup> OPS
Electrical Endurance min.	1 x 10 <sup>5</sup> OPS	5 x 10 <sup>4</sup> OPS	1 x 10 <sup>5</sup> OPS

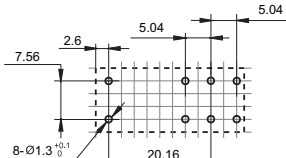
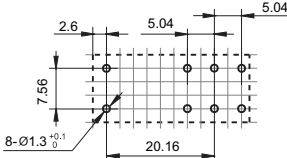
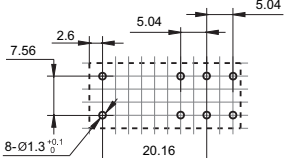

Layout (Bottom view)			
----------------------	---	--	---

Terminal Type	PCB		PCB
Approved Standards	UL/CUL VDE CQC		UL/CUL VDE
File No.	E134517 116934 CQC08002028130	E134517 116934	E134517 116934 CQC08002028130
Cross Reference	OMRON: G2RL PANASONIC: JW1/JW2/DJ SCHRACK: RT FUJITSU: FTR-K1 FINDER: 41 SERIES	OMRON: G5RL-AC SCHRACK: RT/RX RELPOL: RM84/85	SCHRACK: RTH105 16A P&B: RT FUJITSU: FTR-K1

Note: Specification and dimensions in this catalog are subject to change without notice.



## POWER RELAY SELECTION CHART

Type	HF115F-H	HF115F-I	HF115F-Q
Appearance			
Dimensions(L x W x H) mm	29.0 x 12.7 x 15.7	29.0 x 12.7 x 15.7	Vertical: (41.0 x 12.7 x 15.7) Horizontal: (45.0 x 12.7 x 15.7)
Features	<ul style="list-style-type: none"> <li>• High sensitive: 0.25W</li> <li>• 5kV dielectric strength (between coil and contacts)</li> <li>• Creepage distance: 10mm</li> <li>• Meet VDE0700/0631</li> <li>• Product in accordance to IEC 60335-1 available</li> </ul>	<ul style="list-style-type: none"> <li>• High inrush: TV-5 80A (at 125VAC)</li> <li>• 5kV dielectric strength (between coil and contacts)</li> <li>• Creepage distance: 10mm</li> <li>• Meet VDE0700/0631</li> <li>• Product in accordance to IEC 60335-1 available</li> </ul>	<ul style="list-style-type: none"> <li>• Ambient temperature up to 125°C</li> <li>• 5kV dielectric strength (between coil and contacts)</li> <li>• Creepage distance &gt;8mm</li> <li>• Meet VDE0700/0631</li> <li>• UL94, V-0 flammability class</li> <li>• Product in accordance to IEC 60335-1 available</li> </ul>

### Contact Ratings

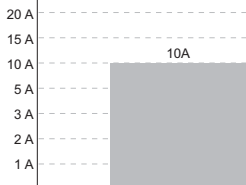
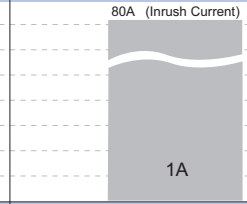
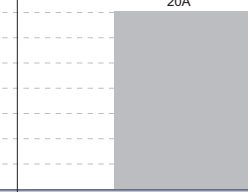
Contact Form	1A, 1B, 1C	1A,1C	1A, 1B
Contact Material	AgSnO <sub>2</sub> , AgNi, AgCdO	AgSnO <sub>2</sub>	AgSnO <sub>2</sub> , AgNi
Max. Rated Switching Current (Resistive load)			
Max. Switching Voltage	440VAC / 300VDC	440VAC / 300VDC	440VAC / 300VDC
Max. Switching Power	2500VA	4000VA	5000VA
Rated Load (Resistive load)	10A 250VAC	1A: 16A 250VAC TV-5, Inrush 80A	20A 250VAC

### Coil Ratings

Rated Voltage	5VDC to 60VDC	5VDC to 110VDC	5VDC to 110VDC
Nominal Operating Power	0.25W	0.4W	0.4W



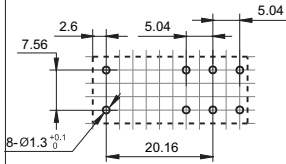
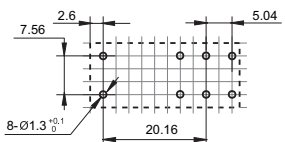
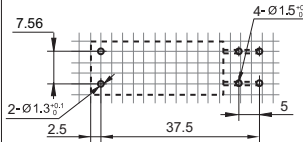

### Specifications

Insulation Resistance	1000MΩ	1000MΩ	1000MΩ
Dielectric Strength (Between coil and contacts)	5000VAC	5000VAC	5000VAC
Ambient Temperature	-40°C to 85°C	-40°C to 85°C	-40°C to 125°C
Operate / Release Time max.	15ms / 8ms	15ms / 8ms	15ms / 8ms
Mechanical Endurance min.	1 x 10 <sup>7</sup> OPS	1 x 10 <sup>7</sup> OPS	1 x 10 <sup>7</sup> OPS
Electrical Endurance min.	1 x 10 <sup>5</sup> OPS	1 x 10 <sup>5</sup> OPS	1 x 10 <sup>5</sup> OPS

Layout (Bottom view)			
Terminal Type	PCB	PCB	PCB, QC
Approved Standards	UL/CUL VDE CQC	UL/CUL VDE CQC	UL/CUL VDE CQC
File No.	E134517 116934 CQC08002028130	E134517 116934 CQC08002028130	E134517 116934 CQC08002028130
Cross Reference	SCHRACK: RT1 Sensitive P&B: RT FUJITSU: FTR-K1	SCHRACK: RT1 Inrush/RX2 P&B: RT FUJITSU: FTR-H1	SCHRACK: RF/41063 125°C

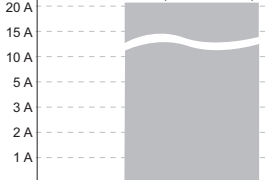
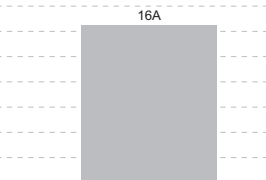

Note: Specification and dimensions in this catalog are subject to change without notice.

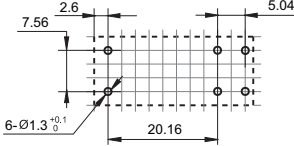
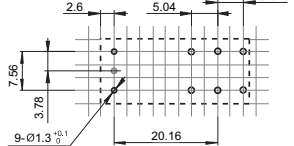
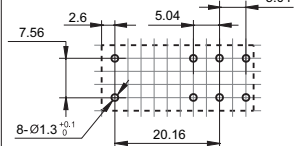
## POWER RELAY SELECTION CHART

Type	HF115F-S	HF115F-L	HF115FP
Appearance			
Dimensions(L x W x H) mm	29.0 x 12.7 x 15.7	29.0 x 12.7 x 15.7	29.0 x 13.0 x 25.5
Features	<ul style="list-style-type: none"> <li>• Special contact struction</li> <li>• Incandescent lamp load: 3000W 230VAC</li> <li>• 5kV dielectric strength (between coil and contacts)</li> <li>• Creepage distance: 10mm</li> <li>• Product in accordance to IEC 60335-1 available</li> <li>• Plastic sealed and flux proofed types available</li> </ul>	<ul style="list-style-type: none"> <li>• Latching relay</li> <li>• 20A switching capability</li> <li>• 5kV dielectric strength (between coil and contacts)</li> <li>• Creepage distance: 11mm-NO/10mm-CO version</li> <li>• Meeting VDE 0700, 0631 reinforce insulation</li> <li>• Product in accordance to IEC 60335-1 available</li> </ul>	<ul style="list-style-type: none"> <li>• Manual test device, Type with mechanical indicator / electrical indicator</li> <li>• 5kV dielectric strength (between coil to contacts)</li> <li>• Creepage distance: 8mm</li> <li>• Meet VDE0700/0631</li> <li>• Sockets available</li> </ul>
<b>Contact Ratings</b>			
Contact Form	1A	1A, 1C	1C   2C
Contact Material	W+AgSnO <sub>2</sub>	AgSnO <sub>2</sub>	AgNi
Max. Rated Switching Current (Resistive load)			
Max. Switching Voltage	440VAC	440VAC / 300VDC	440VAC
Max. Switching Power	4000VA	4000VA	4000VA   2000VA
Rated Load (Resistive load)	Resistive: 16A 250VAC Incandescent Lamp: 3000W 230VAC Inrush current: 165A / 20ms fourescent: 800A/200µs	16A 250VAC	16A 250VAC   8A 250VAC
<b>Coil Ratings</b>			
Rated Voltage	5VDC to 110VDC	5VDC to 24VDC	24VAC to 230VAC / 12VDC to 110VDC
Nominal Operating Power	0.4W	0.4W, 0.6W	0.75VA, 0.4W
<b>Specifications</b>			
Insulation Resistance	1000MΩ	1000MΩ	1000MΩ
Dielectric Strength (Between coil and contacts)	5000VAC	5000VAC	5000VAC
Ambient Temperature	-40°C to 70°C	-40°C to 85°C	-40°C to 70°C
Operate / Release Time max.	15ms / 8ms	10ms / 10ms	15ms / 8ms (DC)
Mechanical Endurance min.	5 x 10 <sup>6</sup> OPS	5 x 10 <sup>6</sup> OPS	5 x 10 <sup>6</sup> OPS
Electrical Endurance min.	1 x 10 <sup>4</sup> OPS	5 x 10 <sup>4</sup> OPS	
Layout (Bottom view)			
Terminal Type	PCB	PCB	PCB
Approved Standards	VDE CQC	UL/CUL VDE	UL/CUL VDE
File No.	E134517 116934 CQC08002028130	E134517 116934	E133481 116934
Cross Reference	TE: RTS3T	PANASONIC: JW SCHRACK: RT1 bistable FUJITSU: FTR-K1L	SCHRACK: XT

Note: Specification and dimensions in this catalog are subject to change without notice.

## POWER RELAY SELECTION CHART

Type	HF158F	HF141FF	HF14FF
Appearance			
Dimensions(L x W x H) mm	29.0 x 12.7 x 15.7	29.0 x 12.6 x 20.6	29.0 x 13.0 x 26.0
Features	<ul style="list-style-type: none"> <li>• 20A switching capability</li> <li>• Low height: 12.5 mm</li> <li>• 5kV dielectric strength (between coil and contacts)</li> <li>• Creepage distance: 10mm</li> <li>• Product in accordance to IEC 60335-1 available</li> </ul>	<ul style="list-style-type: none"> <li>• 10A switching capability</li> <li>• 5kV dielectric strength (between coil and contacts)</li> <li>• Plastic sealed and flux proofed types available</li> </ul>	<ul style="list-style-type: none"> <li>• 10A switching capability</li> <li>• 5kV dielectric strength (between coil and contacts)</li> <li>• 1 Form A and 1 Form C configurations</li> <li>• Plastic sealed and flux proofed types available</li> </ul>

### Contact Ratings

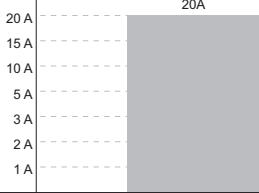
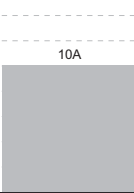
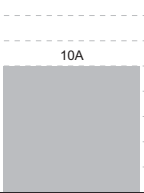
Contact Form	1A, 1C	1A, 1B, 1C	1A, 1C
Contact Material	AgSnO <sub>2</sub> , AgNi	AgSnO <sub>2</sub> , AgCdO	AgSnO <sub>2</sub> , AgNi, AgCdO
Max. Rated Switching Current (Resistive load)			
Max. Switching Voltage	440VAC	250VAC / 30VDC	277VAC / 30VDC
Max. Switching Power	5000VA	2500VA / 300W	2770VA / 300W
Rated Load (Resistive load)	16A 250VAC	Heavy: 10A 250VAC/30VDC Standard: 8A 250VAC/30VDC 10A 125VAC	10A 277VAC/30VDC TV-5 120VAC

### Coil Ratings

Rated Voltage	5VDC to 48VDC	5VDC to 48VDC	3VDC to 60VDC
Nominal Operating Power	0.4W	0.55W, 0.72W	0.53W

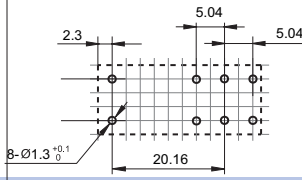
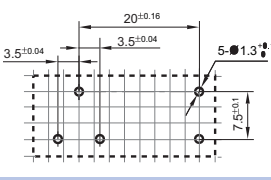
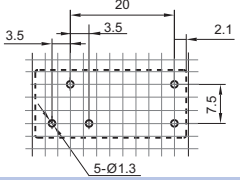

### Specifications

Insulation Resistance	1000MΩ	1000MΩ	1000MΩ
Dielectric Strength (Between coil and contacts)	5000VAC	5000VAC	5000VAC
Ambient Temperature	-40°C to 85°C	-40°C to 70°C	-40°C to 70°C
Operate / Release Time max.	15ms / 8ms	15ms / 5ms	15ms / 5ms
Mechanical Endurance min.	2 x 10 <sup>7</sup> OPS	1 x 10 <sup>7</sup> OPS	1 x 10 <sup>7</sup> OPS
Electrical Endurance min.	1 x 10 <sup>5</sup> OPS	1 x 10 <sup>5</sup> OPS	1 x 10 <sup>5</sup> OPS

Layout (Bottom view)			
Terminal Type	PCB	PCB	PCB
Approved Standards	UL/CUL VDE	UL/CUL CQC	UL/CUL TÜV CQC
File No.	E134517 40032833	E133481 CQC09002034351	E134517 R50140759 CQC09002035073
Cross Reference	OMRON: G2RL SCHRACK: RT	OMRON: G2R PANASONIC: JW FUJITSU: FTR-F1/VS NEC: TP FINDER: 40.31	OMRON: G2R PANASONIC: JR1/JR1A FUJITSU: VS NEC: CH P&B: RKA/RKS

Note: Specification and dimensions in this catalog are subject to change without notice.

## POWER RELAY SELECTION CHART

Type	HF14FW	HF140FF	HF25F
Appearance			
Dimensions(L x W x H) mm	29.0 x 13.0 x 26.5	29.0 x 13.0 x 26.3	22.8 x 12.3 x 24.4
Features	<ul style="list-style-type: none"> <li>• 20A switching capability</li> <li>• 4kV dielectric strength (between coil and contacts)</li> <li>• Plastic sealed and flux proofed types available</li> </ul>	<ul style="list-style-type: none"> <li>• 10A switching capability</li> <li>• 5kV dielectric strength (between coil and contacts)</li> <li>• 2.0mm contact gap available</li> <li>• Plastic sealed and flux proofed types available</li> </ul>	<ul style="list-style-type: none"> <li>• 20A switching capability</li> <li>• 5kV impulse withstand voltage (between coil and contacts)</li> <li>• small and for microwave oven</li> <li>• PCB &amp; QC layouts</li> <li>• Flux proofed types available</li> </ul>

### Contact Ratings

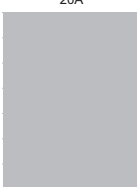
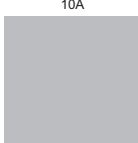
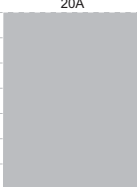
Contact Form	1A, 1B, 1C	2A, 2C	1A
Contact Material	AgSnO <sub>2</sub> , AgCdO	AgSnO <sub>2</sub> , AgNi, AgCdO	AgSnO <sub>2</sub>
Max. Rated Switching Current (Resistive load)	20A	10A	20A
			
Max. Switching Voltage	277VAC / 30VDC	250VAC / 30VDC	250VAC / 30VDC
Max. Switching Power	5540VA / 480W	2500VA / 240W	5000VA / 480W
Rated Load (Resistive load)	Resistive: 16A 277VAC/24VDC Motor: 1HP 240VAC TV-8 125VAC (NO contact)	5A 250VAC 10A 250VAC 8A 30VDC	20A 250VAC Motor: 1.5HP 250VAC

### Coil Ratings

Rated Voltage	5VDC to 60VDC	3VDC to 60VDC	5VDC to 24VDC
Nominal Operating Power	0.53W, 0.72W	0.53W, 0.8W, 1.4W	0.5W

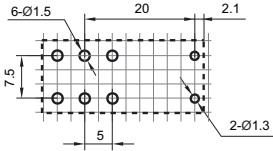
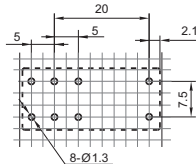
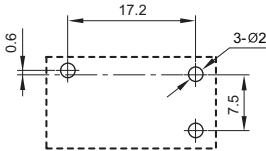

### Specifications

Insulation Resistance	1000MΩ	1000MΩ	1000MΩ
Dielectric Strength (Between coil and contacts)	4000VAC	5000VAC	5000VAC
Ambient Temperature	-40°C to 85°C	-40°C to 85°C	-40°C to 85°C
Operate / Release Time max.	15ms / 5ms	15ms / 5ms	15ms / 5ms
Mechanical Endurance min.	1 x 10 <sup>7</sup> OPS	Standard: 1 x 10 <sup>7</sup> OPS W Type: 5 x 10 <sup>5</sup> OPS	2 x 10 <sup>6</sup> OPS
Electrical Endurance min.	1 x 10 <sup>5</sup> OPS	1 x 10 <sup>5</sup> OPS	1 x 10 <sup>5</sup> OPS

Layout (Bottom view)			
Terminal Type	PCB	PCB	PCB, QC
Approved Standards	UL/CUL VDE CQC	UL/CUL TÜV CQC	UL/CUL VDE TÜV CQC
File No.	E134517 40023508 CQC09002030293	E134517 R50149131 CQC09002030294	E134517 40026917 R50207576 CQC09002028692
Cross Reference	OMRON: G2R PANASONIC: JR1AF FUJITSU: FBR610 P&B: RKA/RKS	OMRON: G2R/G2RG PANASONIC: JR2/JR2A FUJITSU: FBR-F1/VSB NEC: TP P&B: RKA/RKS	OMRON: G5G PANASONIC: LE

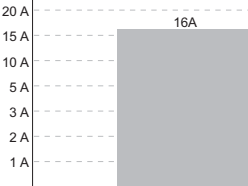
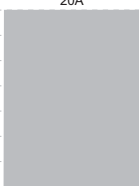
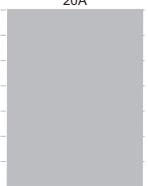
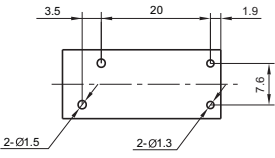
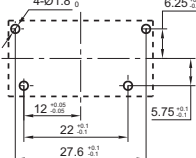
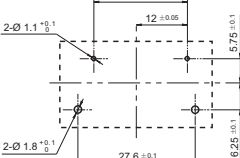

Note: Specification and dimensions in this catalog are subject to change without notice.

## POWER RELAY SELECTION CHART

Type	HF62F	HF102F	HF161F
Appearance			
Dimensions(L x W x H) mm	29.0 x 12.6 x 24.4	30.5 x 16.0 x 23.5	30.4 x 15.9 x 23.3
Features	<ul style="list-style-type: none"> <li>• 20A switching capability</li> <li>• 5kV dielectric strength (between coil and contacts)</li> <li>• 10kV impulse withstand voltage (between coil and contacts)</li> <li>• creepage distance: 8mm</li> </ul>	<ul style="list-style-type: none"> <li>• Heavy load up to 5000VA</li> <li>• Ideal for motor switching</li> <li>• Withstand inrush current of 80A</li> <li>• PCB &amp; QC layouts available</li> </ul>	<ul style="list-style-type: none"> <li>• 4.5kV dielectric strength (between coil and contacts)</li> <li>• Heavy load up to 6250VA</li> <li>• Ideal for motor switching</li> <li>• PCB layouts available</li> </ul>
<b>Contact Ratings</b>			
Contact Form	1A	1A	1A
Contact Material	AgSnO <sub>2</sub>	AgSnO <sub>2</sub> , AgCdO	AgSnO <sub>2</sub> , AgCdO
Max. Rated Switching Current (Resistive load)			
Max. Switching Voltage	277VAC / 30VDC	250VAC	250VAC
Max. Switching Power	4000VA / 480W	6250VA	6250VA
Rated Load (Resistive load)	16A 250VAC/30VDC	20A 250VAC Motor: 2HP 240VAC	20A 250VAC Motor: 2HP 240VAC
<b>Coil Ratings</b>			
Rated Voltage	5VDC to 48VDC	5VDC to 48VDC	5VDC to 48VDC
Nominal Operating Power	0.54W	0.9W	0.9W
<b>Specifications</b>			
Insulation Resistance	1000MΩ	1000MΩ	1000MΩ
Dielectric Strength (Between coil and contacts)	5000VAC	4500VAC	4500VAC
Ambient Temperature	-40°C to 85°C	-25°C to 85°C	-40°C to 85°C
Operate / Release Time max.	20ms / 10ms	20ms / 10ms	20ms / 10ms
Mechanical Endurance min.	1 x 10 <sup>7</sup> OPS	2 x 10 <sup>6</sup> OPS	2 x 10 <sup>6</sup> OPS
Electrical Endurance min.	1 x 10 <sup>5</sup> OPS	1 x 10 <sup>5</sup> OPS	1 x 10 <sup>5</sup> OPS
Layout (Bottom view)			
Terminal Type	PCB, QC	PCB, QC	PCB
Approved Standards	UL/CUL TÜV CQC	UL/CUL VDE CQC	UL/CUL VDE CQC
File No.	E133481 R50147086 CQC09002028470	E134517 40024142 CQC008002028081	E134517 40031410 CQC10002050943
Cross Reference	OMRON: G5J PANASONIC: JR1AF-TMP FUJITSU: VR OEG: OMIF	OMRON: G4A PANASONIC: LF OEG: PCFN	OMRON: G4A PANASONIC: LF OEG: PCFN

Note: Specification and dimensions in this catalog are subject to change without notice.

## POWER RELAY SELECTION CHART

Type	HF161F-W	HF160F	HF37F
Appearance			
Dimensions(L x W x H) mm	30.4 x 15.9 x 23.3	30.4 x 15.9 x 25.4	35.2 x 32.2 x 24.0
Features	<ul style="list-style-type: none"> <li>• 31A switching capable</li> <li>• Applicable to inverter used for photovoltaic power generation systems</li> <li>• Ideal for UPS</li> <li>• 1.5mm contact gap (compliant to European Photovoltaic Standard VDE0126)</li> <li>• The clearance distance between contact and coil is bigger than 6.4mm, the creepage distance is bigger than 8mm.</li> </ul>	<ul style="list-style-type: none"> <li>• 4.5kV dielectric strength (between coil and contacts)</li> <li>• Heavy load up to 6250VA</li> <li>• Ideal for motor switching</li> <li>• PCB &amp; QC layouts</li> </ul>	<ul style="list-style-type: none"> <li>• 30A switching capability</li> <li>• 1 Form A configuration</li> <li>• 70A withstands inrush current</li> <li>• TV-15(at 120VAC) available</li> </ul>

### Contact Ratings

Contact Form	1A	1A	1A
Contact Material	AgSnO <sub>2</sub>	AgSnO <sub>2</sub> , AgCdO	AgSnO <sub>2</sub> , AgCdO
Max. Rated Switching Current (Resistive load)	30A	20A	30A
	26A	20A	30A
Max. Switching Voltage	277VAC	250VAC	277VAC
Max. Switching Power	7750VA	6250VA	7500VA
Rated Load (Resistive load)	Resistive: 26A 250VAC Inductive: 31A 250VAC	20A 250VAC Motor: 2HP 240VAC	30A 250VAC

### Coil Ratings

Rated Voltage	9VDC to 24VDC	5VDC to 48VDC	5VDC to 60VDC
Nominal Operating Power	1.4W	0.9W	1.2W

### Specifications

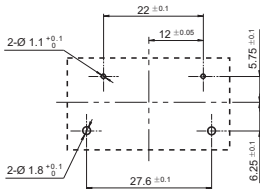
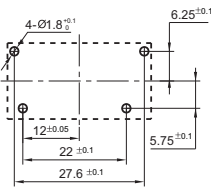
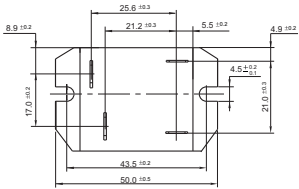

Insulation Resistance	1000MΩ	1000MΩ	1000MΩ
Dielectric Strength (Between coil and contacts)	4500VAC	4500VAC	4000VAC
Ambient Temperature	-40°C to 60°C (Apply rated voltage to coil) -40°C to 85°C (Apply holding voltage to coil, which is 45% to 80% that of rated voltage)	-40°C to 85°C	-40°C to 70°C
Operate / Release Time max.	20ms / 10ms	20ms / 10ms	20ms / 5ms
Mechanical Endurance min.	1 x 10 <sup>6</sup> OPS	2 x 10 <sup>6</sup> OPS	5 x 10 <sup>6</sup> OPS
Electrical Endurance min.	3 x 10 <sup>4</sup> OPS	1 x 10 <sup>5</sup> OPS	1 x 10 <sup>5</sup> OPS

Layout (Bottom view)			
----------------------	---	--	---

Terminal Type	PCB	PCB, QC	QC
Approved Standards	UL/CUL VDE CQC	UL/CUL VDE CQC	UL/CUL VDE CQC
File No.	E134517 40031410 CQC10002050943	E134517 40024142 CQC08001024034	E134517 40025378 CQC09002028695
Cross Reference	PANASONIC: LF-G OEG: PCFN SOLAR	OMRON: G4F PANASONIC: JM FUJITSU: FTR-K3/VH OEG: PCF	FUJITSU: VF

Note: Specification and dimensions in this catalog are subject to change without notice.

## POWER RELAY SELECTION CHART

Type	HF105F-1	HF105F-2	HF105F-4
Appearance			
Dimensions(L x W x H) mm	32.3 x 27.1 x 20	32.4 x 27.5 x 27.8	50.0 x 27.2 x 27.8
Features	<ul style="list-style-type: none"> <li>• 40A switching capability</li> <li>• PCB coil terminals, ideal for heavy duty load</li> <li>• 4kV dielectric strength (between coil and contacts)</li> <li>• Heavy load up to 7,200VA</li> <li>• Unenclosed, plastic sealed and dust protected types available</li> </ul>	<ul style="list-style-type: none"> <li>• 40A switching capability</li> <li>• PCB coil terminals, ideal for heavy duty load</li> <li>• Heavy load up to 7,200VA</li> <li>• Plastic sealed and dust protected types available</li> </ul>	<ul style="list-style-type: none"> <li>• 40A switching capability</li> <li>• 2.5kV dielectric strength (between coil and contacts)</li> <li>• Heavy load up to 7,200VA</li> <li>• Plastic sealed and dust protected types available</li> </ul>

### Contact Ratings

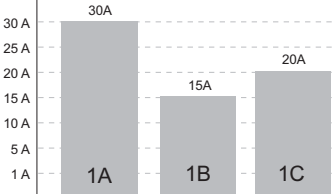
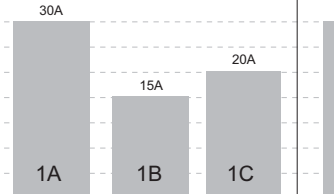
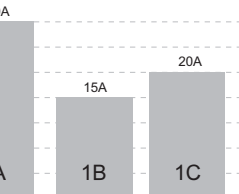
Contact Form	1A, 1B, 1C	1A, 1B, 1C	1A, 1B, 1C
Contact Material	AgSnO <sub>2</sub> , AgCdO	AgSnO <sub>2</sub> , AgCdO	AgSnO <sub>2</sub> , AgCdO
Max. Rated Switching Current (Resistive load)			
Max. Switching Voltage	277VAC / 28VDC	277VAC / 28VDC	277VAC / 28VDC
Max. Switching Power	7200VA / 560W	7200VA / 560W	7200VA / 560W
Rated Load (Resistive load)	1A: 30A 240VAC/20A 28VDC 1B: 15A 240VAC/10A 28VDC 1C: 20A/10A 240VAC/28VDC L Type(1A): 25A 240VAC/20A 28VDC	1A: 30A 240VAC/20A 28VDC 1B: 15A 240VAC/10A 28VDC 1C: 20A/10A 240VAC/28VDC L Type(1A): 25A 240VAC/20A/28VDC	1A: 30A 240VAC/20A 28VDC 1B: 15A 240VAC/10A 28VDC 1C: 20A/10A 240VAC/28VDC L Type(1A): 25A 240VAC/20A/28VDC

### Coil Ratings

Rated Voltage	12VAC to 277VAC / 5VDC to 110VDC	12VAC to 277VAC / 5VDC to 110VDC	12VAC to 277VAC / 5VDC to 110VDC
Nominal Operating Power	2.0VA, 0.9W	2.0VA, 0.9W	2.0VA, 0.9W

### Specifications

Insulation Resistance	1000MΩ	1000MΩ	1000MΩ
Dielectric Strength (Between coil and contacts)	4000VAC	2500VAC	2500VAC
Ambient Temperature	DC: -55°C to 85°C AC: -55°C to 60°C	DC: -55°C to 85°C AC: -55°C to 60°C	DC: -55°C to 85°C AC: -55°C to 60°C
Operate / Release Time max.	15ms / 10ms	15ms / 10ms	15ms / 10ms
Mechanical Endurance min.	1 x 10 <sup>7</sup> OPS	1 x 10 <sup>7</sup> OPS	1 x 10 <sup>7</sup> OPS
Electrical Endurance min.	1 x 10 <sup>5</sup> OPS	1 x 10 <sup>5</sup> OPS	1 x 10 <sup>5</sup> OPS

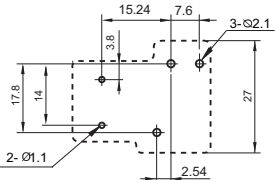
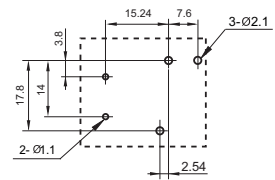
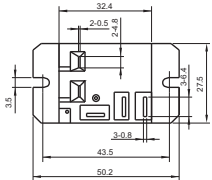
Layout (Bottom view)			
----------------------	---	--	---



Terminal Type	PCB	PCB, QC	QC
Approved Standards	UL/CUL VDE CQC	UL/CUL VDE CQC	UL/CUL VDE CQC
File No.	E134517 40025518 CQC09002031229(DC Type)	E134517 40025518 CQC09002031229(DC Type)	E134517 40025518 CQC09002031229(DC Type)

Cross Reference	OMRON: G8P PANASONIC: JTN/JTV OEG: ORU P&B: T9A/T90	OMRON: G7G/G8P PANASONIC: JT OEG: ORU P&B: 491/T9A	OMRON: G7G/G8P PANASONIC: JT OEG: ORU P&B: T9A
-----------------	--	---	---

Note: Specification and dimensions in this catalog are subject to change without notice.



## POWER RELAY SELECTION CHART

Type	HF105F-5	HF2100	HF2110 / HF2120
Appearance			
Dimensions(L x W x H) mm	32.4 x 27.3 x 27.8	32.0 x 27.5 x 28.0	28.4 x 23.5 x 15.3
Features	<ul style="list-style-type: none"> <li>• 40A switching capability</li> <li>• PCB coil terminals, ideal for heavy duty load</li> <li>• Heavy load up to 7,200VA</li> <li>• 4kV dielectric strength (between coil and contacts)</li> <li>• Plastic sealed and dust protected types available</li> </ul>	<ul style="list-style-type: none"> <li>• PCB coil terminals, ideal for heavy duty load</li> <li>• 2.5kV dielectric strength (between coil and contacts)</li> <li>• Plastic sealed and flux proofed types available</li> </ul>	<ul style="list-style-type: none"> <li>• 30A switching capability</li> <li>• 2.5kV dielectric strength (between coil and contacts)</li> <li>• Plastic sealed and flux proofed types available</li> </ul>

### Contact Ratings

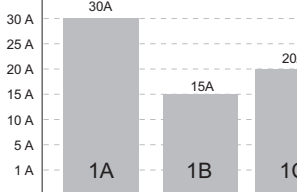
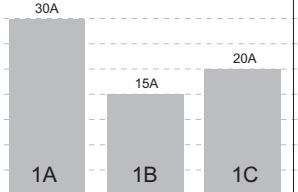
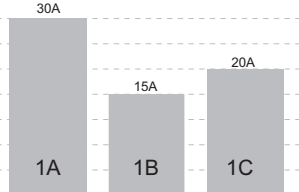
Contact Form	1A, 1B, 1C	1A, 1B, 1C	1A, 1B, 1C
Contact Material	AgSnO <sub>2</sub> , AgCdO	AgCdO	AgCdO
Max. Rated Switching Current (Resistive load)			
Max. Switching Voltage	277VAC / 28VDC	277VAC / 30VDC	277VAC / 30VDC
Max. Switching Power	7200VA / 560W	7200VA / 600W	7200VA / 600W
Rated Load (Resistive load)	1A: 30A 240VAC/20A 28VDC 1B: 15A 240VAC/10A 28VDC 1C: 20A/10A 240VAC/28VDC L Type(1A): 25A 240VAC/20A/28VDC	1A: 30A 240VAC/20A 30VDC 1B: 15A 240VAC/10A 30VDC 1C: 20A/10A 240VAC/30VDC	1A: 30A 240VAC/20A 30VDC 1B: 15A 240VAC/10A 30VDC 1C: 20A/10A 240VAC/30VDC

### Coil Ratings

Rated Voltage	12VAC to 277VAC / 5VDC to 110VDC	5VDC to 110VDC	5VDC to 110VDC
Nominal Operating Power	2.0VA, 0.9W	0.9W	0.9W

### Specifications

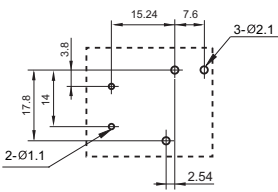
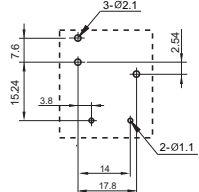
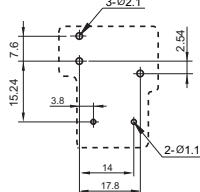

Insulation Resistance	1000MΩ	1000MΩ	1000MΩ
Dielectric Strength (Between coil and contacts)	4000VAC / 2500VAC	2500VAC	2500VAC
Ambient Temperature	DC: -55°C to 85°C AC: -55°C to 60°C	-55°C to 85°C	-55°C to 85°C
Operate / Release Time max.	15ms / 10ms	15ms / 10ms	15ms / 10ms
Mechanical Endurance min.	1 x 10 <sup>7</sup> OPS	1 x 10 <sup>7</sup> OPS	1 x 10 <sup>7</sup> OPS
Electrical Endurance min.	1 x 10 <sup>5</sup> OPS	1 x 10 <sup>5</sup> OPS	1 x 10 <sup>5</sup> OPS

Layout (Bottom view)			
Terminal Type	PCB, QC	PCB, QC	PCB, QC
Approved Standards	UL/CUL VDE CQC	UL/CUL TÜV CQC	UL/CUL CQC
File No.	E134517 40025518 CQC09002031229(DC Type)	E134517 R50153835 CQC08002027546	E134517 CQC08002027546
Cross Reference	OMRON: G7G/G8P PANASONIC: JTN OEG: ORU P&B: T90/T9A	OMRON: G7G PANASONIC: JT P&B: 491/T9A ZETTLER: AZ2100	OMRON: G7G PANASONIC: JT NEC: CT P&B: 491/T90 ZETTLER: AZ2110/AZ2120



Note: Specification and dimensions in this catalog are subject to change without notice.



## POWER RELAY SELECTION CHART

Type	HF2150	HF2160	HF116F-1
Appearance			
Dimensions(L x W x H) mm	31.8 x 27.0 x 19.1	32.0 x 27.5 x 19.8	50.5 x 32.9 x 36.0
Features	<ul style="list-style-type: none"> <li>• 30A switching capability</li> <li>• 2.5kV dielectric strength (between coil and contacts)</li> <li>• Heavy load up to 7,200VA</li> <li>• Plastic sealed and flux proofed type available</li> </ul>	<ul style="list-style-type: none"> <li>• 30A switching capability</li> <li>• PCB coil terminals, ideal for heavy duty load</li> <li>• 2.5KV dielectric strength (between coil and contacts)</li> <li>• Plastic sealed and Dust proofed types available</li> </ul>	<ul style="list-style-type: none"> <li>• 30A switching capability</li> <li>• 4kV dielectric strength (between coil and contacts)</li> <li>• Heavy load up to 7500VA</li> <li>• 3mm contact gap available</li> </ul>

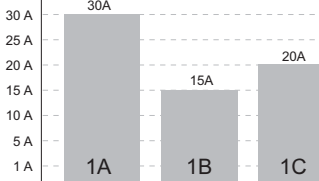
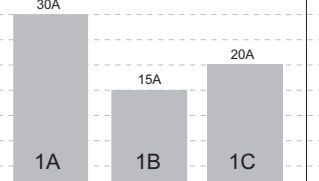
### Contact Ratings

Contact Form	1A, 1B, 1C	1A, 1B, 1C	1A, 2A
Contact Material	AgCdO	AgCdO	AgSnO <sub>2</sub> , AgCdO
Max. Rated Switching Current (Resistive load)			
Max. Switching Voltage	277VAC / 30VDC	277VAC / 30VDC	277VAC / 30VDC
Max. Switching Power	7200VA / 600W	7200VA / 600W	8310VA
Rated Load (Resistive load)	1A: 30A 240VAC/20A 30VDC 1B: 15A 240VAC/10A 30VDC 1C: 20A/10A 240VAC/30VDC	1A: 30A 240VAC/20A 30VDC 1B: 15A 240VAC/10A 30VDC 1C: 20A/10A 240VAC/30VDC	1A: 30A 240VAC/30A 277VAC 2A: 25A 240VAC/25A 277VAC

### Coil Ratings

Rated Voltage	5VDC to 110VDC	5VDC to 110VDC	6VAC to 220VAC/3VDC to 200VDC
Nominal Operating Power	0.9W	0.9W	2.7VA, 1.9W

### Specifications

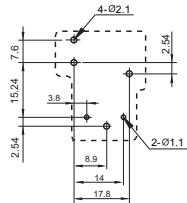
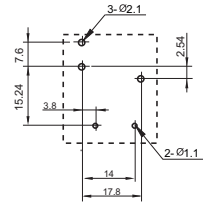
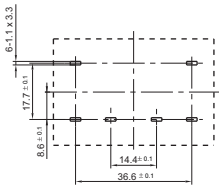

Insulation Resistance	1000MΩ	1000MΩ	1000MΩ
Dielectric Strength (Between coil and contacts)	2500VAC	2500VAC	4000VAC
Ambient Temperature	-55°C to 85°C	-55°C to 85°C	-55°C to 70°C
Operate / Release Time max.	15ms / 10ms	15ms / 10ms	30ms / 30ms
Mechanical Endurance min.	1 x 10 <sup>7</sup> OPS	1 x 10 <sup>7</sup> OPS	1 x 10 <sup>7</sup> OPS
Electrical Endurance min.	1 x 10 <sup>5</sup> OPS	1 x 10 <sup>5</sup> OPS	1 x 10 <sup>5</sup> OPS

Layout (Bottom view)			
----------------------	---	--	---



Terminal Type	PCB	PCB, QC	PCB, QC, Panel Mount
Approved Standards	UL/CUL CQC	UL/CUL TÜV CQC	UL/CUL TÜV CQC
File No.	E134517 CQC08002027546	E134517 R50153835 CQC08002027546	E134517 R50154722 CQC09002031231(DC Type)
Cross Reference	OMRON: G7G PANASONIC: JTN/JTV NEC: CT P&B: T9A/T90 ZETTLER: AZ2150/AZ2151	PANASONIC: JT NEC: CT P&B: T9A/T90 ZETTLER: AZ2160	OMRON: G7L PANASONIC: HE

Note: Specification and dimensions in this catalog are subject to change without notice.

## POWER RELAY SELECTION CHART

Type	HF116F-2	HF116F-3	HF92F
Appearance			
Dimensions(L x W x H) mm	51.5 x 34.9 x 36.0	50.5 x 32.9 x 51.0	52.0 x 33.7 x 26.7
Features	<ul style="list-style-type: none"> <li>• 30A switching capability</li> <li>• 4kV dielectric strength (between coil and contacts)</li> <li>• 3mm contact gap available</li> </ul>	<ul style="list-style-type: none"> <li>• 30A switching capability</li> <li>• 4kV dielectric strength (between coil and contacts)</li> <li>• Heavy load up to 7500VA</li> <li>• 3mm contact gap available</li> </ul>	<ul style="list-style-type: none"> <li>• 30A switching capability</li> <li>• Creepage distance: 8mm</li> <li>• 4kV dielectric strength (between coil and contacts)</li> <li>• Plastic sealed and dust protected types</li> <li>• PCB &amp; QC layouts</li> </ul>

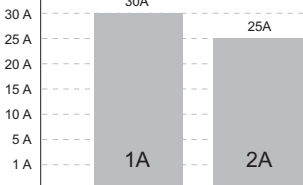
### Contact Ratings

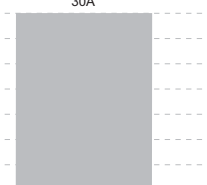
Contact Form	1A, 2A	1A, 2A	2A, 2C
Contact Material	AgSnO <sub>2</sub> , AgCdO	AgSnO <sub>2</sub> , AgCdO	AgSnO <sub>2</sub> , AgCdO
Max. Rated Switching Current (Resistive load)			
Max. Switching Voltage	277VAC	277VAC	277VAC
Max. Switching Power	8310VA	8310VA	8310VA
Rated Load (Resistive load)	1A: 30A 240VAC/30A 277VAC 2A: 25A 240VAC/25A 277VAC	1A: 30A 240VAC/30A 277VAC 2A: 25A 240VAC/25A 277VAC	NO: 30A 250VAC/30A 277VAC NC: 3A 250VAC/3A 277VAC

### Coil Ratings

Rated Voltage	6VAC to 220VAC 3VDC to 200VDC	6VAC to 220VAC/240VAC 3VDC to 200VDC	24VAC to 277VAC 5VDC to 110VDC
Nominal Operating Power	2.7VA, 1.9W	2.7VA, 1.9W	4.0VA, 1.7W

### Specifications

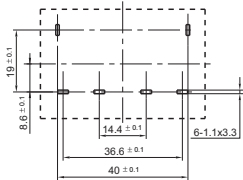
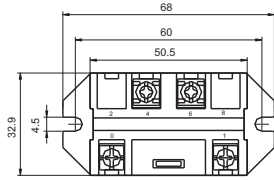
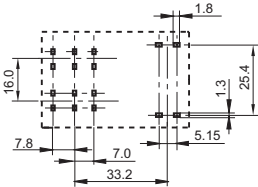

Insulation Resistance	1000MΩ	1000MΩ	1000MΩ
Dielectric Strength (Between coil and contacts)	4000VAC	4000VAC	4000VAC
Ambient Temperature	-55°C to 70°C	-55°C to 70°C	AC : -40°C to 65°C DC : -40°C to 85°C
Operate / Release Time max.	30ms / 30ms	30ms / 30ms	25ms / 25ms
Mechanical Endurance min.	1 x 10 <sup>7</sup> OPS	1 x 10 <sup>7</sup> OPS	5 x 10 <sup>6</sup> OPS
Electrical Endurance min.	1 x 10 <sup>5</sup> OPS	1 x 10 <sup>5</sup> OPS	1 x 10 <sup>5</sup> OPS

Layout (Bottom view)			
Terminal Type	PCB, QC, Panel Mount	PCB, QC, Panel Mount	PCB, QC
Approved Standards	UL/CUL TÜV CQC	UL/CUL TÜV CQC	UL/CUL VDE CQC
File No.	E134517 R50154722 CQC09002031231(DC Type)	E134517 R50154722 CQC09002031231(DC Type)	E134517 40016109 CQC09002037814(DC type)



Cross Reference	OMRON: G7L PANASONIC: HE	OMRON: G7L PANASONIC: HE	P&B, SCHRACK: T92 FEME: CS/CF30
-----------------	-----------------------------	-----------------------------	------------------------------------

Note: Specification and dimensions in this catalog are subject to change without notice.

## POWER RELAY SELECTION CHART

Type	HF84F	HF94F	HF8565
Appearance			
Dimensions(L x W x H) mm	47.0 x 32.0 x 28.5	47.0 x 32.0 x 28.5	51.2 x 46.6 x 36.5
Features	<ul style="list-style-type: none"> <li>• 16A switching capability</li> <li>• 2.5kV dielectric strength (between coil and contacts)</li> <li>• Panel mount, various terminal types</li> </ul>	<ul style="list-style-type: none"> <li>• 25A switching capability</li> <li>• 2kV dielectric strength (between coil and contacts)</li> <li>• Panel mount, various terminal types</li> </ul>	<ul style="list-style-type: none"> <li>• Motor start potential relay</li> <li>• 50A switching capability</li> <li>• 1 Form B configurations</li> <li>• 250" quick connect termination</li> <li>• Variety of mounting positions</li> </ul>

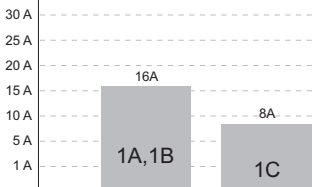
### Contact Ratings

Contact Form	1A, 1B, 1C	1A, 1B, 1C, 1A+1B	1B
Contact Material	AgCe	AgCe, AgCdO	AgCdO
Max. Rated Switching Current (Resistive load)			
Max. Switching Voltage	240VAC	277VAC	
Max. Switching Power	3840VA	4986VA	
Rated Load (Resistive load)	1A, 1B: 16A 120/240VAC 1C: 8A 120/240VAC	18A 277VAC	16A(make and break) 400VAC 35A(break only) 400VAC 50A(break only) 400VAC

### Coil Ratings

Rated Voltage	6VAC to 277VAC / 6VDC to 120VDC	6VAC to 277VAC / 6VDC to 120VDC	
Nominal Operating Power	3.5VA, 2.1W	4.0VA, 2.4W	5.0VA

### Specifications

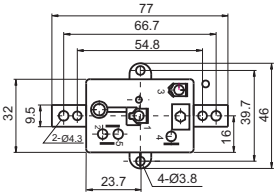
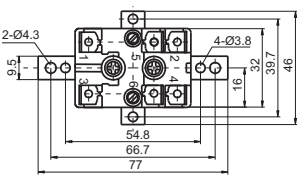
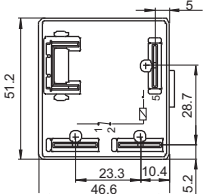

Insulation Resistance	1500MΩ	500MΩ	
Dielectric Strength (Between coil and contacts)	2500VAC	2000VAC	
Ambient Temperature	-40°C to 65°C	-40°C to 65°C	
Operate / Release Time max.	25ms / 25ms	25ms / 25ms	
Mechanical Endurance min.	1 x 10 <sup>6</sup> OPS	1 x 10 <sup>6</sup> OPS	7.5 x 10 <sup>5</sup> OPS
Electrical Endurance min.	1 x 10 <sup>5</sup> OPS	1 x 10 <sup>5</sup> OPS	5 x 10 <sup>5</sup> OPS (at 16A 400VAC)

Layout (Bottom view)			
Terminal Type	QC	QC	QC
Approved Standards	UL/CUL	UL/CUL	UL/CUL
File No.	E134517	E134517	SA13318

Cross Reference	WHITE RODGERS 90-290 to 295 90-203,204,205	WHITE RODGERS 90-360,362,364 90-370,372,374 90-380,382,384	GE: 3ARR22 ELECTRICA: RVA
-----------------	--	---	------------------------------

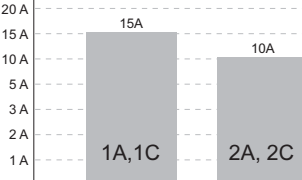
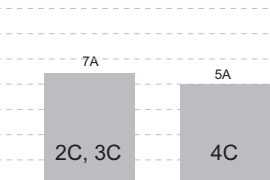
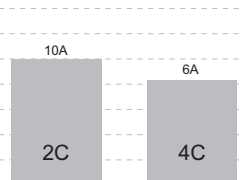
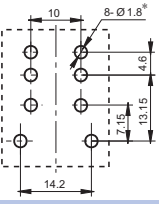
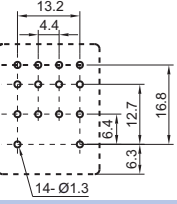
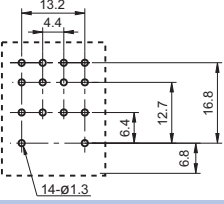

Note: Specification and dimensions in this catalog are subject to change without notice.

## INDUSTRIAL RELAY SELECTION CHART

Type	HF13F	HF18FF	HF18FA
Appearance			
Dimensions(L x W x H) mm	28.0 x 21.5 x 35.0	28.0 x 21.5 x 35.0	28.0 x 21.5 x 36.0
Features	<ul style="list-style-type: none"> <li>• 15A switching capability</li> <li>• 1.5kV dielectric strength (between coil and contacts)</li> <li>• Various terminals available</li> <li>• 1 &amp; 2 pole configurations</li> <li>• Conform to the CE low voltage directive</li> <li>• Sockets available</li> </ul>	<ul style="list-style-type: none"> <li>• 7A switching capability (2C, 3C type)</li> <li>• 2 to 4 pole configurations</li> <li>• Conform to the CE low voltage directive</li> <li>• Gold plated contact available</li> <li>• Sockets available</li> </ul>	<ul style="list-style-type: none"> <li>• Test button available</li> <li>• 2 &amp; 4 pole configurations</li> <li>• Various terminals available</li> <li>• 2kV dielectric strength (between coil and contacts)</li> <li>• Gold plated contact available</li> <li>• Dust protected type available</li> <li>• Sockets available</li> </ul>
<b>Contact Ratings</b>			
Contact Form	1A, 2A, 1C, 2C	2C, 3C, 4C	2C, 4C
Contact Material	AgCe, AgCdO	AgSnO <sub>2</sub> , AgCe	AgSnO <sub>2</sub> , AgNi, AgCdO
Max. Rated Switching Current			
Max. Switching Voltage	250VAC / 30VDC	250VAC / 30VDC	250VAC / 30VDC
Max. Switching Power	1A, 1C: 3750VA / 450W 2A, 2C: 2500VA / 300W	2C, 3C: 1750VA / 210W 4C: 1250VA / 150W	2C: 2500VA / 300W 4C: 1500VA / 180W
Rated Load (Resistive load)	1A, 1C: 15A 250VAC/30VDC 2A, 2C: 10A 250VAC/30VDC	2C, 3C: 7A 250VAC/30VDC 4C: 5A 250VAC/30VDC	2C: 10A 250VAC/30VDC 4C: 6A 250VAC/30VDC
<b>Coil Ratings</b>			
Rated Voltage	6VAC to 240VAC 5VDC to 220VDC	6VAC to 240VAC 5VDC to 110VDC	6VAC to 240VAC 5VDC to 120VDC
Nominal Operating Power	1.2VA to 1.8VA, 0.9W to 1.1W	1.2VA to 1.8VA, 0.9W to 1.1W	1.2VA to 1.8VA, 0.9W to 1.1W
<b>Specifications</b>			
Insulation Resistance	500MΩ	1000MΩ	1000MΩ
Dielectric Strength (Between coil and contacts)	1500VAC	1500VAC	2000VAC
Ambient Temperature	-40°C to 70°C	-40°C to 70°C	-40°C to 70°C
Operate / Release Time max.	25ms / 25ms (DC type)	25ms / 25ms (DC type)	20ms / 20ms (DC type)
Mechanical Endurance min.	1 x 10 <sup>7</sup> OPS	2 x 10 <sup>7</sup> OPS	1 x 10 <sup>7</sup> OPS
Electrical Endurance min.	1 x 10 <sup>5</sup> OPS	1 x 10 <sup>5</sup> OPS	1 x 10 <sup>5</sup> OPS
Layout (Bottom view)			
Terminal Type	PCB, Plug-in	PCB, Plug-in	PCB, Plug-in
Approved Standards	UL/CUL TÜV CQC	UL/CUL TÜV CQC	UL/CUL
File No.	E133481 R50154518 CQC09002030028 / 09002030029	E133481 R50147087 CQC09002030026 / 09002030027	E133481
Cross Reference	OMRON: LY1/2 PANASONIC: HL FUJISTU: FRL260 NEC: KML SCHRACK: TM	OMRON: MY2/3/4 FINDER: 55.32/55.33/55.34 IDEC: RM2S/ RM4S SCHNEIDER: RXM2/4 TE: KHAU-11/17	OMRON: MY2/4 FINDER: 55.32/55.34

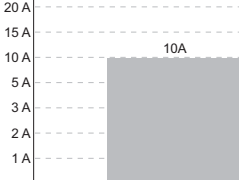
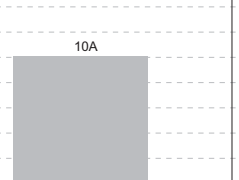
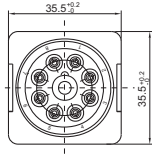
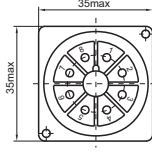

Note: Specification and dimensions in this catalog are subject to change without notice.

## INDUSTRIAL RELAY SELECTION CHART

Type	HF10FH	HF10FF	
Appearance			
Dimensions(L x W x H) mm	35.5 x 35.5 x 55.3	35.0 x 35.0 x 55.0	
Features	<ul style="list-style-type: none"> <li>• 10A switching capability</li> <li>• Long endurance</li> <li>• Industry standard 8 or 11 round terminals</li> <li>• Sockets available</li> <li>• With push button</li> <li>• Smoke cover type available</li> </ul>	<ul style="list-style-type: none"> <li>• 10A switching capability</li> <li>• Industry standard 8 or 11 round terminals</li> <li>• Sockets available</li> <li>• Long endurance</li> </ul>	
<b>Contact Ratings</b>			
Contact Form	2C, 3C	2C, 3C	
Contact Material	AgSnO <sub>2</sub> , AgCdO	AgSnO <sub>2</sub> , AgCdO	
Max. Rated Switching Current			
Max. Switching Voltage	250VAC / 30VDC	250VAC / 30VDC	
Max. Switching Power	2500VA / 300W	2500VA / 300W	
Rated Load (Resistive load)	2C: 10A 250VAC/30VDC 3C: NO: 10A 250VAC/30VDC NC: 5A 250VAC/30VDC	2C: 10A 250VAC/30VDC 3C: NO: 10A 250VAC/30VDC NC: 5A 250VAC/30VDC	
<b>Coil Ratings</b>			
Rated Voltage	6VAC to 230VAC 6VDC to 110VDC	6VAC to 230VAC 6VDC to 110VDC	
Nominal Operating Power	2.7VA, 1.5W	2.7VA, 1.5W	
<b>Specifications</b>			
Insulation Resistance	500MΩ	500MΩ	
Dielectric Strength (Between coil and contacts)	2500VAC	1500VAC	
Ambient Temperature	-40°C to 55°C	-40°C to 55°C	
Operate / Release Time max.	30ms / 30ms (DC type)	30ms / 30ms (DC type)	
Mechanical Endurance min.	1 x 10 <sup>7</sup> OPS	1 x 10 <sup>7</sup> OPS	
Electrical Endurance min.	1 x 10 <sup>5</sup> OPS	1 x 10 <sup>5</sup> OPS	
Layout (Bottom view)			
Terminal Type	Octal and Undecal Type Plug	Octal and Undecal Type Plug	
Approved Standards	UL/CUL	UL/CUL	
File No.	E134517	E134517	
Cross Reference	OMRON: MK2/3 SCHNEIDER: RUM C2/C3 FINDER: 60.12/ 60.13 FEME: RCP/ RCPT	OMRON: MK2/3 SCHNEIDER: RUM C2/C3 FINDER: 60.12/ 60.13	

Note: Specification and dimensions in this catalog are subject to change without notice.

## SAFETY RELAY SELECTION CHART

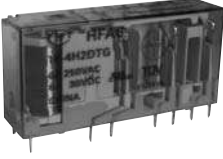
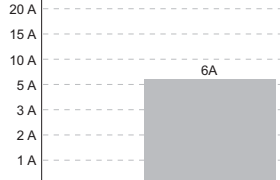
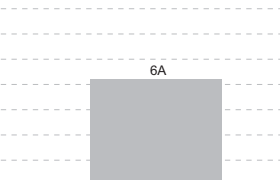
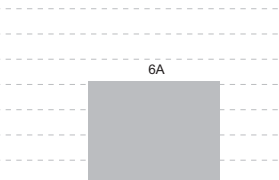
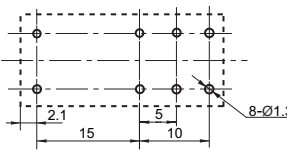
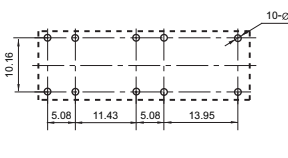
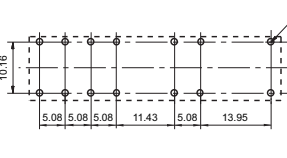
Type	HFA2	HFA4	HFA6
Appearance			
Dimensions(L x W x H) mm	29.0 x 12.6 x 25.5	40.0 x 13.0 x 24.0	50.0 x 13.0 x 24.0
Features	<ul style="list-style-type: none"> <li>Multi contact arrangements: 2 Form C(2C type), 1NO+1NC (HD1 type), 1NO+1NC (HD2 type)</li> <li>Forcibly guided contacts according to EN50205</li> <li>6A switching capability</li> <li>10kV surge voltage between coil &amp; contacts and 6kV between contact sets</li> </ul>	<ul style="list-style-type: none"> <li>Multi contact arrangements: 2NO+2NC, 3NO+1NC</li> <li>Forcibly guided contacts according to EN50205</li> <li>6A switching capability</li> <li>360mW low input power</li> <li>10kV surge voltage between input and output</li> </ul>	<ul style="list-style-type: none"> <li>Multi contact arrangements: 5NO+1NC, 4NO+2NC, 3NO+3NC</li> <li>Forcibly guided contacts according to EN50205</li> <li>6A switching capability</li> <li>Low input power: 500mW</li> <li>10kV surge voltage between input and output</li> </ul>
<b>Contact Ratings</b>			
Contact Form	2C, 1NO+1NC(HD1&HD2 type)	2NO+2NC, 3NO+1NC	5NO+1NC, 4NO+2NC, 3NO+3NC
Contact Material	AgSnO <sub>2</sub>	AgSnO <sub>2</sub>	AgSnO <sub>2</sub>
Max. Rated Switching Current			
Max. Switching Voltage	400VAC / 30VDC	400VAC / 30VDC	400VAC / 30VDC
Max. Switching Power	1500VA / 180W	1500VA / 180W	1500VA / 180W
Rated Load (Resistive load)	6A 250VAC / 30VDC	6A 250VAC / 30VDC	6A 250VAC / 30VDC
<b>Coil Ratings</b>			
Rated Voltage	5VDC to 110VDC	6VDC to 48VDC	6VDC to 48VDC
Nominal Operating Power	700mW	500mW	500mW
<b>Specifications</b>			
Insulation Resistance	1000MΩ	1000MΩ	1000MΩ
Dielectric Strength (Between coil and contacts)	4000VAC	4000VAC	4000VAC
Ambient Temperature	-40°C to 70°C	-40°C to 85°C	-40°C to 85°C
Operate / Release Time max.	15ms / 10ms	20ms / 20ms	20ms / 20ms
Mechanical Endurance min.	1 x 10 <sup>7</sup> OPS	1 x 10 <sup>7</sup> OPS	1 x 10 <sup>7</sup> OPS
Electrical Endurance min.	NO:1 x 10 <sup>5</sup> OPS; NC:1 x 10 <sup>4</sup> OPS	1 x 10 <sup>5</sup> OPS	1 x 10 <sup>5</sup> OPS
Layout (Bottom view)			
Terminal Type	PCB	PCB	PCB
Approved Standards	UL/CUL TÜV	UL/CUL VDE	UL/CUL TÜV
File No.	E134517 B120753286005	E134517 40034342	E134517 B120553286004
Cross Reference	TE: SR2M HENGSTLER: K-RBS DOLD: OA5669 ELESTA: SIR282	OMRON: G7SA TE: SR4D/M PANASONIC: SFS	OMRON: G7SA TE: SR6 PANASONIC: SFS

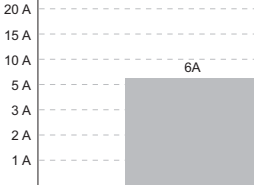

Note: Specification and dimensions in this catalog are subject to change without notice.

## SAFETY RELAY SELECTION CHART

<b>Type</b>	HF3701		
Appearance			
Dimensions(L x W x H) mm	113.5 x 99.0 x 22.5		
Features	<ul style="list-style-type: none"> <li>• Safety relay module of 2, 4 pole</li> <li>• Redundant design of circuit</li> <li>• With self-check function</li> <li>• Automatic or manual reset of contacts without time delay</li> <li>• Meet requirements of EN 60947-5-1 and EN 60204-1, with safety grade up to PLe of ISO13849-1</li> </ul>		
<b>Contact Ratings</b>			
Contact Form	2A, 1NO+1NC, 4NO, 3NO+1NC		
Contact Material	AgSnO <sub>2</sub>		
Max. Rated Switching Current (Resistive load)			
Max. Switching Voltage	250VAC / 30VDC		
Max. Switching Power	1500VA / 144W		
Rated Load (Resistive load)	6A 250VAC / 24VDC		
<b>Coil Ratings</b>			
Rated Voltage	24VAC / 24VDC		
Nominal Operating Power			
<b>Specifications</b>			
Insulation Resistance	1000MΩ		
Dielectric Strength (Between coil and contacts)			
Ambient Temperature	-20°C to 55°C		
Operate / Release Time max.	45ms / 20ms(dual-channel)		
Mechanical Endurance min.	1 x 10 <sup>7</sup> OPS		
Electrical Endurance min.	1 x 10 <sup>5</sup> OPS		
Layout (Bottom view)			
Terminal Type	DIN 35 Rail (Mounting Type)		
Approved Standards	CCC CE		
File No.	2011010303502723 N8130453286010		
Cross Reference	OMRON: G9SA-301 PILZ: PNOZ x2 PHOENIX: ESM4 SCHNEIDER: XPS AC		

Note: Specification and dimensions in this catalog are subject to change without notice.

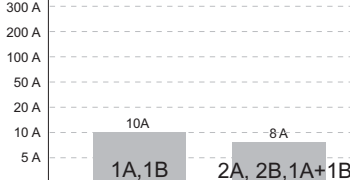
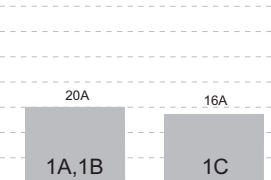
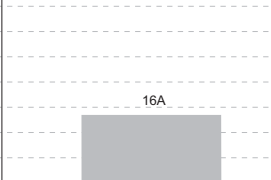
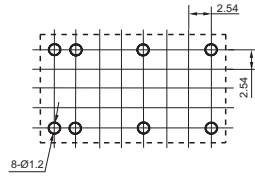
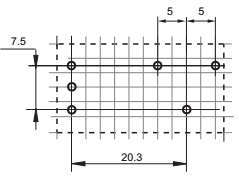
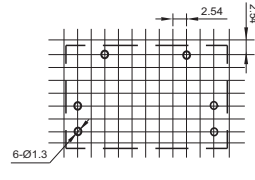

## LATCHING RELAY SELECTION CHART

Type	HFE7	HFE20	HFE39
Appearance			
Dimensions(L x W x H) mm	20.0 x 15.0 x 10.2	29.0 x 12.7 x 15.7	20.0 x 30.0 x 10.2
Features	<ul style="list-style-type: none"> <li>• High switching capacity</li> <li>• High sensitivity: 200mW</li> <li>• 4kV dielectric strength (between coil &amp; contacts)</li> <li>• 1 Form A, 1 Form B, 2 Form A 2 Form B and 1A+1B contact arrangements available.</li> <li>• Latching and single side stable types available</li> </ul>	<ul style="list-style-type: none"> <li>• 16A switching capability</li> <li>• Latching relay</li> <li>• Max.inrush current Capacitor 500A/2ms (Contact material: W+AgSnO<sub>2</sub>)</li> </ul>	<ul style="list-style-type: none"> <li>• 16A switching capability</li> <li>• Latching relay</li> <li>• Max.inrush current capability 350A/2ms</li> </ul>
<b>Contact Ratings</b>			
Contact Form	1A,1B, 2A, 2B,1A+1B	1A, 1B, 1C	2A,2B
Contact Material	AgSnO <sub>2</sub> , AgNi	AgSnO <sub>2</sub> , W+AgSnO <sub>2</sub>	AgSnO <sub>2</sub>
Max. Rated Switching Current (Resistive load)			
Max. Switching Voltage	277VAC	250VAC	250VAC
Max. Switching Power	2500VA    2000VA	4000VA	4000VA
Rated Load (Resistive load)	10A 30VDC 10A 250VAC	8A 30VDC 8A 250VAC	16A 250VAC
<b>Coil Ratings</b>			
Rated Voltage	3VDC to 24VDC	3VDC to 24VDC	3VDC to 48VDC
Nominal Operating Power	0.2W, 0.28W, 0.42W, 0.3W	0.4W, 0.6W	1W, 2W
<b>Specifications</b>			
Insulation Resistance	1000MΩ	1000MΩ	1000MΩ
Dielectric Strength (Between coil and contacts)	4000VAC	4400VAC	4000VAC
Ambient Temperature	-40°C to 70°C	-40°C to 85°C	-40°C to 85°C
Operate / Release Time max.	10ms / 10ms	15ms / 15ms	15ms / 15ms
Mechanical Endurance min.	1 x 10 <sup>7</sup> OPS	1 x 10 <sup>6</sup> OPS	1 x 10 <sup>6</sup> OPS
Electrical Endurance min.	1 x 10 <sup>5</sup> OPS (2A: 3 x 10 <sup>4</sup> OPS)	1 x 10 <sup>5</sup> OPS (1A, 1B)	1 x 10 <sup>5</sup> OPS
Layout (Bottom view)			
Terminal Type	PCB	PCB	PCB
Approved Standards	UL/CUL VDE	UL/CUL VDE	UL/CUL VDE
File No.	E134517 40027342	E134517 40031831	E134517
Cross Reference	PANASONIC:DK OMRON: G6C	TYCO:RT GRUNER:715	

Note: Specification and dimensions in this catalog are subject to change without notice.



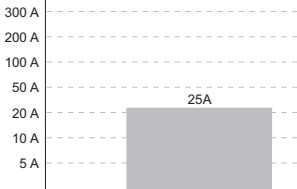
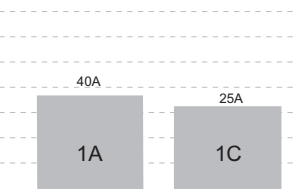
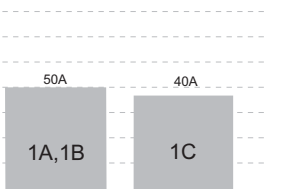
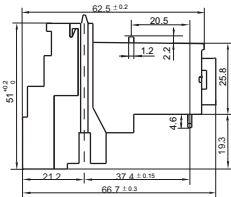
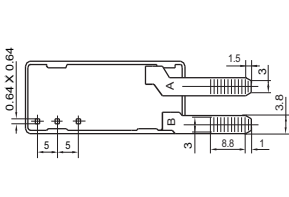
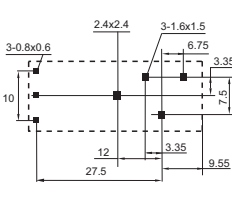

## LATCHING RELAY SELECTION CHART

Type	HFE27	HFE26	HFE10
Appearance			
Dimensions(L x W x H) mm	66.7 x 51 x 13.6	38.8 x 15.0 x 28.7	39.0 x 15.0 x 30.2
Features	<ul style="list-style-type: none"> <li>• 16A, 25A switching capability</li> <li>• Latching relay</li> <li>• Manual switch function available</li> <li>• Dielectric strength: more than 4kV (between coil and contacts)</li> </ul>	<ul style="list-style-type: none"> <li>• 25A, 40A switching capability</li> <li>• Latching relay</li> <li>• Manual switch function available</li> <li>• Creepage distance: 8mm</li> <li>• Dielectric strength: more than 4kV (between coil and contacts)</li> </ul>	<ul style="list-style-type: none"> <li>• 50A switching capability</li> <li>• Lamp load up to 5000W</li> <li>• Motor load up to 5HP</li> <li>• Max. inrush current 500A/2ms</li> <li>• Manual switch function available</li> <li>• Relays with 1.5mm contact gap are available</li> </ul>
<b>Contact Ratings</b>			
Contact Form	1A, 1B, 1C	1A, 1C	1A, 1B, 1C
Contact Material	AgSnO <sub>2</sub>	AgSnO <sub>2</sub>	AgSnO <sub>2</sub>
Max. Rated Switching Current (Resistive load)			
Max. Switching Voltage	250VAC	250VAC	440VAC
Max. Switching Power	4000VA	10000VA	12500VA   10000VA
Rated Load (Resistive load)	16A 250VAC	1A: 40A 250VAC 1C: 25A 250VAC	50A 250VAC   40A 250VAC
<b>Coil Ratings</b>			
Rated Voltage	3VDC to 24VDC	5VDC to 48VDC	6VDC to 48VDC
Nominal Operating Power	0.7W, 1.4W	1A: 1.5W, 3W 1C: 1.0W, 2.0W	1.5W, 3.0W
<b>Specifications</b>			
Insulation Resistance	1000MΩ	1000MΩ	1000MΩ
Dielectric Strength (Between coil and contacts)	4000VAC	4000VAC	4000VAC
Ambient Temperature	-40°C to 85°C	-40°C to 70°C	-40°C to 70°C
Operate / Release Time max.	20ms / 20ms	10ms / 10ms	15ms / 15ms
Mechanical Endurance min.	1 x 10 <sup>6</sup> OPS	1 x 10 <sup>6</sup> OPS	1 x 10 <sup>6</sup> OPS
Electrical Endurance min.	3 x 10 <sup>4</sup> OPS(25A) 9.5 x 10 <sup>4</sup> OPS(16A)	3 x 10 <sup>4</sup> OPS	1 x 10 <sup>5</sup> OPS(1A, 1B)
Layout (Bottom view)			
Terminal Type	PCB	PCB & QC	PCB
Approved Standards	UL/CUL		UL/CUL VDE
File No.	E134517		E134517 40035869
Cross Reference	GRUNER: 708	GRUNER: 703	GRUNER: 704L

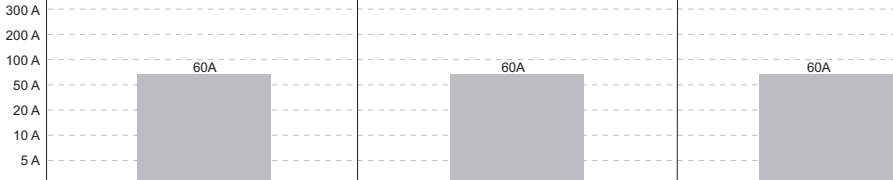
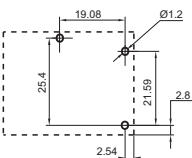
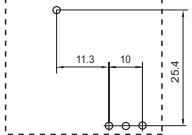
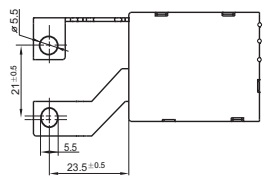

Note: Specification and dimensions in this catalog are subject to change without notice.

## LATCHING RELAY SELECTION CHART

Type	HFE9	HFE19-60	HFE19-60(391)
Appearance			
Dimensions(L x W x H) mm	38.0 x 30.0 x 16.0	38.0 x 30.0 x 16.5	38.0 x 30.9 x 16.5
Features	<ul style="list-style-type: none"> <li>Latching relay</li> <li>60A switching capability</li> <li>The relay can stand 1440A peak current for 10ms</li> <li>4kV dielectric strength(between coil and contacts)</li> <li>Heavy load up to 15000VA</li> </ul>	<ul style="list-style-type: none"> <li>60A switching capability</li> <li>Latching relay</li> <li>Making test 1800A peak short circuit current</li> <li>Carrying the 3500A short circuit current without explosion</li> </ul>	<ul style="list-style-type: none"> <li>60A switching capability</li> <li>Latching relay</li> <li>The relay can stand 1440A peak current for 10ms</li> <li>Integratged one-piece installation solution, facilitate your installation requirement.</li> </ul>
<b>Contact Ratings</b>			
Contact Form	1A,1B	1A,1B	1A,1B
Contact Material	AgSnO <sub>2</sub>	AgSnO <sub>2</sub>	AgSnO <sub>2</sub>
Max. Rated Switching Current (Resistive load)			
Max. Switching Voltage	250VAC	250VAC	250VAC
Max. Switching Power	15000VA	22500VA	15000VA
Rated Load (Resistive load)	60A 250VAC 50A 250VAC 40A 250VAC	60A 250VAC	60A 250VAC
<b>Coil Ratings</b>			
Rated Voltage	5VDC to 48VDC	9VDC to 48VDC	5VDC to 48VDC
Nominal Operating Power	1.0W, 2.0W	1.0W, 2.0W	1.0W, 2.0W
<b>Specifications</b>			
Insulation Resistance	1000MΩ	1000MΩ	1000MΩ
Dielectric Strength (Between coil and contacts)	4000VAC	4000VAC	4000VAC
Ambient Temperature	-40°C to 70°C	-40°C to 70°C	-40°C to 70°C
Operate / Release Time max.	20ms / 20ms	20ms / 20ms	20ms / 20ms
Mechanical Endurance min.	1 x 10 <sup>6</sup> OPS (Meter:1 x 10 <sup>5</sup> OPS)	1 x 10 <sup>5</sup> OPS	1 x 10 <sup>5</sup> OPS
Electrical Endurance min.	1 x 10 <sup>5</sup> OPS (40A 250VAC)	6000 OPS	5000 OPS
Layout (Bottom view)			
Terminal Type	QC	QC	QC
Approved Standards	UL/CUL CQC		CQC
File No.	E133481 CQC07017019644		CQC12002086396
Cross Reference	GRUNER: 704		

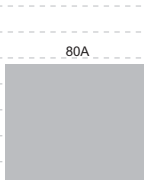
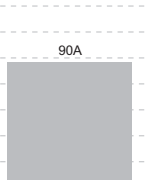
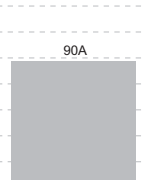
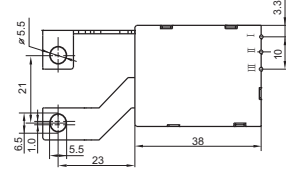
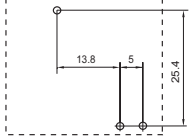
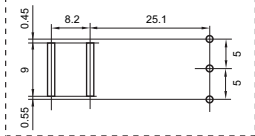

Note: Specification and dimensions in this catalog are subject to change without notice.

## LATCHING RELAY SELECTION CHART

Type	HFE19-80(391)	HFE19-90	HFE42
Appearance			
Dimensions(L x W x H) mm	38.0 x 30.9 x 16.5	38.0 x 30.0 x 16.5	38.1 x 30.0 x 16.5
Features	<ul style="list-style-type: none"> <li>• 80A switching capability</li> <li>• Latching relay</li> <li>• Integrated one-piece installation solution, facilitate your installation requirement.</li> </ul>	<ul style="list-style-type: none"> <li>• 90A Latching relay</li> <li>• Carrying 2400A peak current/10ms and contact won't welded</li> <li>• Carrying the 6000A short circuit current/10ms without explosion</li> </ul>	<ul style="list-style-type: none"> <li>• 90A Latching relay</li> <li>• Carrying 2400A peak current/10ms and contact won't welded</li> <li>• Carrying the 6000A short circuit current/10ms without explosion</li> </ul>
<b>Contact Ratings</b>			
Contact Form	1A,1B	1A,1B	1A,1B
Contact Material	AgSnO <sub>2</sub>	AgSnO <sub>2</sub>	AgSnO <sub>2</sub>
Max. Rated Switching Current (Resistive load)			
Max. Switching Voltage	250VAC	250VAC	250VAC
Max. Switching Power	20000VA	22500VA	22500VA
Rated Load (Resistive load)	80A 250VAC	90A 250VAC	90A 250VAC
<b>Coil Ratings</b>			
Rated Voltage	5VDC to 48VDC	5VDC to 48VDC	5VDC to 48VDC
Nominal Operating Power	1.0W, 2.0W	1.5W, 3.0W	1.5W, 3.0W
<b>Specifications</b>			
Insulation Resistance	1000MΩ	1000MΩ	1000MΩ
Dielectric Strength (Between coil and contacts)	4000VAC	4000VAC	4000VAC
Ambient Temperature	-40°C to 70°C	-40°C to 70°C	-40°C to 70°C
Operate / Release Time max.	20ms / 20ms	20ms / 20ms	20ms / 20ms
Mechanical Endurance min.	1 x 10 <sup>5</sup> OPS	1 x 10 <sup>6</sup> OPS (Meter: 1 x 10 <sup>5</sup> OPS)	1 x 10 <sup>6</sup> OPS (Meter: 1 x 10 <sup>5</sup> OPS)
Electrical Endurance min.	5000 OPS	6000 OPS	6000 OPS
Layout (Bottom view)			
Terminal Type	QC	QC	QC
Approved Standards		VDE CQC	
File No.		40037408 CQC12002086394	
Cross Reference		GRUNER: 704	

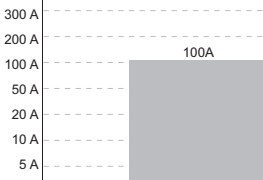
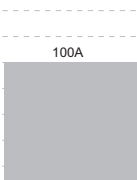
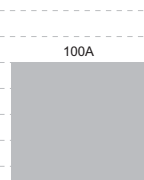
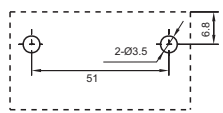
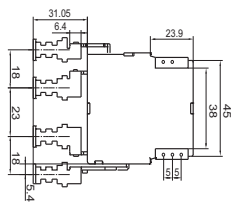
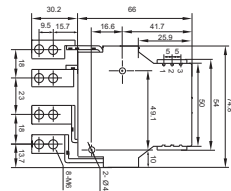

Note: Specification and dimensions in this catalog are subject to change without notice.

## LATCHING RELAY SELECTION CHART

Type	HFE22	HFE37	HFE28
Appearance			
Dimensions(L x W x H) mm	60.0 x 40.0 x 21.0	60.0 x 52.0 x 23.0	66.0 x 75.0 x 23.5
Features	<ul style="list-style-type: none"> <li>• 100A switching capability</li> <li>• Latching relay</li> <li>• Carrying the 1500A short circuit current without explosion</li> </ul>	<ul style="list-style-type: none"> <li>• Latching relay</li> <li>• 100A switching capability</li> <li>• According to the fault current and electrical life test of IEC 62055-31: UC1, UC2, UC3</li> <li>• AC-voltage driving is feasible</li> <li>• 2.5kV dielectric strength (between coil and coil)</li> </ul>	<ul style="list-style-type: none"> <li>• Latching relay</li> <li>• 100A switching capability at Res.load</li> <li>• According to the fault current and electrical life test of IEC 62055-31: UC1, UC2, UC3</li> <li>• AC-voltage driving is feasible</li> <li>• 2.5kV dielectric strength (between coil and coil)</li> </ul>
<b>Contact Ratings</b>			
Contact Form	1A,1B	2SH, 2SD	2A,2B, 2SH, 2SD
Contact Material	AgSnO <sub>2</sub>	AgSnO <sub>2</sub>	AgSnO <sub>2</sub>
Max. Rated Switching Current (Resistive load)			
Max. Switching Voltage	440VAC	440VAC	440VAC
Max. Switching Power	27700VA / 2800W	27700VA / 2800W	27700VA/2800W
Rated Load (Resistive load)	100A 277VAC / 28VDC	100A 277VAC / 28VDC	100A 277VAC / 28VDC
<b>Coil Ratings</b>			
Rated Voltage	6VDC to 48VDC	6VDC to 48VDC / 230VAC	6VDC to 48VDC / 230VAC
Nominal Operating Power	2.4W, 4.8W	4.0W, 8.0W	5.0W, 10.0W
<b>Specification</b>			
Insulation Resistance	1000MΩ	1000MΩ	1000MΩ
Dielectric Strength (Between coil and contacts)	4000VAC	4000VAC	4000VAC
Ambient Temperature	-40°C to 70°C	-40°C to 85°C	-40°C to 85°C
Operate / Release Time max.	20ms / 20ms	20ms / 20ms	20ms / 20ms
Mechanical Endurance min.	1 x 10 <sup>5</sup> OPS	1 x 10 <sup>5</sup> OPS	1 x 10 <sup>5</sup> OPS
Electrical Endurance min.	1 x 10 <sup>4</sup> OPS	10000 OPS	10000 OPS
Layout (Bottom view)			
Terminal Type	QC	QC	QC
Approved Standards	UL/CUL		
File No.	E133481		
Cross Reference	GRUNER: 721 / 722		GRUNER: 741

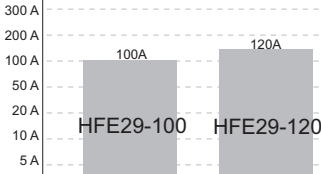
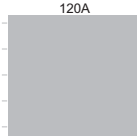
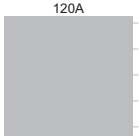
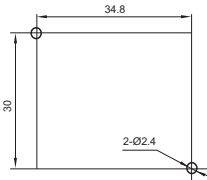
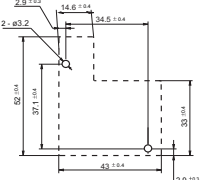
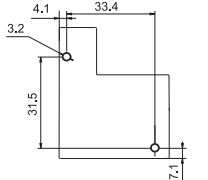

Note: Specification and dimensions in this catalog are subject to change without notice.

## LATCHING RELAY SELECTION CHART

Type	HFE29		HFE12	HFE21
Appearance				
Dimensions(L x W x H) mm	43.0 × 37.0 × 22		52.0 x 43.0 x 22.0	52.0 x 43.0 x 22.0
Features	<ul style="list-style-type: none"> <li>Latching relay</li> <li>100A、120A switching capability at Res.load</li> <li>According to the fault current and electrical life test of IEC 62055-31: UC1, UC2, UC3</li> </ul>		<ul style="list-style-type: none"> <li>Latching relay</li> <li>120A switching capability at Res.load</li> <li>According to the fault current and electrical life test of IEC 62055-31: UC1, UC2, UC3</li> </ul>	<ul style="list-style-type: none"> <li>Latching relay</li> <li>120A switching capability at Res.load</li> <li>According to the fault current and electrical life test of IEC 62055-31: UC1, UC2, UC3</li> </ul>
<b>Contact Ratings</b>				
Contact Form	SH, SD		1A,1B	1A,1B, 1SH, 1SD
Contact Material	AgSnO <sub>2</sub>		AgSnO <sub>2</sub>	AgSnO <sub>2</sub>
Max. Rated Switching Current (Resistive load)				
Max. Switching Voltage	440VAC		440VAC	440VAC
Max. Switching Power	25000VA	30000VA	33240VA / 3360W	33240VA / 3360W
Rated Load (Resistive load)	100A 277VAC	120A 277VAC	120A 277VAC / 28VDC	120A 277VAC / 28VDC
<b>Coil Ratings</b>				
Rated Voltage	6VDC to 48VDC		6VDC to 48VDC	6VDC to 48VDC
Nominal Operating Power	2.4W, 3.0W, 4.8W, 6.0W		2.4W, 4.8W	3.0W, 6.0W
<b>Specifications</b>				
Insulation Resistance	1000MΩ		1000MΩ	1000MΩ
Dielectric Strength (Between coil and contacts)	4000VAC		4000VAC	4000VAC
Ambient Temperature	-40°C to 70°C		-40°C to 70°C	-40°C to 85°C
Operate / Release Time max.	20ms / 20ms		20ms / 20ms	20ms / 20ms
Mechanical Endurance min.	1 x 10 <sup>5</sup> OPS		1 x 10 <sup>5</sup> OPS	1 x 10 <sup>5</sup> OPS
Electrical Endurance min.	10000 OPS		10000 OPS	10000 OPS
Layout (Bottom view)				
Terminal Type	QC		QC	QC
Approved Standards			CQC	
File No.			CQC12002086395	
Cross Reference			GRUNER: 721 / 722	GRUNER: 721 / 722

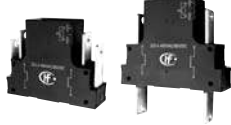
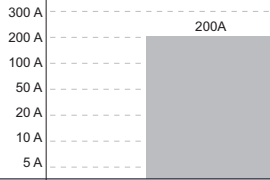
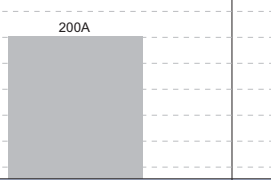
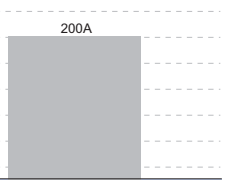
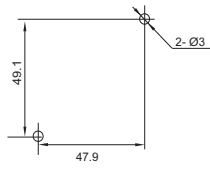
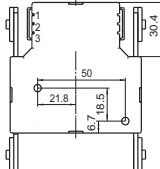
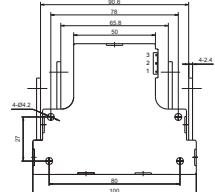

Note: Specification and dimensions in this catalog are subject to change without notice.

## LATCHING RELAY SELECTION CHART

Type	HFE31	HFE25	HFE6
Appearance			
Dimensions(L x W x H) mm	61.3 x 57.0 x 29.3	73.3 x 74.8 x 29.5	100.0 x 80.0 x 29.8
Features	<ul style="list-style-type: none"> <li>• Latching relay</li> <li>• 200A switching capability</li> <li>• Carrying:7kA peak current/500ms</li> <li>• According to the fault current test of IEC 62055-31:UC3 (Carrying: 6kA current / 10ms; Making:3kA current / 10ms)</li> </ul>	<ul style="list-style-type: none"> <li>•Latching relay</li> <li>•200A switching capability</li> <li>•According to ANSI C 12.1 (Carrying: 12kA current / 66.7ms; 7kA peak current/100ms )</li> <li>•Switching power up to 55.4kVA</li> </ul>	<ul style="list-style-type: none"> <li>• Latching relay</li> <li>• 200A switching capability</li> <li>• Strong resistance ability to shock &amp; vibration</li> <li>• Heavy load up to 55.4kVA</li> <li>• 4kV dielectric strength (between coil and contacts)</li> </ul>
<b>Contact Ratings</b>			
Contact Form	SH, SD	2A,2B	2A,2B
Contact Material	AgSnO <sub>2</sub>	AgSnO <sub>2</sub>	AgSnO <sub>2</sub>
Max. Rated Switching Current (Resistive load)			
Max. Switching Voltage	400VAC	440VAC	440VAC
Max. Switching Power	50kVA	55400VA / 5600W	55400VA / 5600W
Rated Load (Resistive load)	200A 250VAC	200A 277VAC / 28VDC	200A 277VAC / 28VDC
<b>Coil Ratings</b>			
Rated Voltage	6VDC to 48VDC	12VDC to 48VDC	12VDC to 48VDC
Nominal Operating Power	5W, 10W	12W, 24W	12W, 24W
<b>Specifications</b>			
Insulation Resistance	1000MΩ	1000MΩ	1000MΩ
Dielectric Strength (Between coil and contacts)	4000VAC	4000VAC	4000VAC
Ambient Temperature	-40°C to 85°C	-40°C to 85°C	-40°C to 85°C
Operate / Release Time max.	15ms / 15ms	20ms / 20ms	30ms / 30ms
Mechanical Endurance min.	1 x 10 <sup>5</sup> OPS	5 x 10 <sup>4</sup> OPS	1 x 10 <sup>5</sup> OPS
Electrical Endurance min.	5000 OPS	6000 OPS	1 x 10 <sup>4</sup> OPS
Layout (Bottom view)			
Terminal Type	QC	QC	QC
Approved Standards			
File No.			
Cross Reference		GRUNER: 740	GRUNER: 740

**Note:** Specification and dimensions in this catalog are subject to change without notice.

## LATCHING RELAY SELECTION CHART

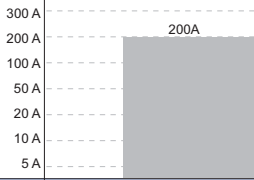
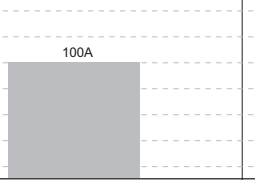
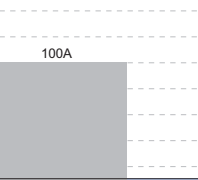
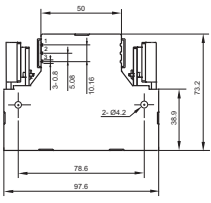
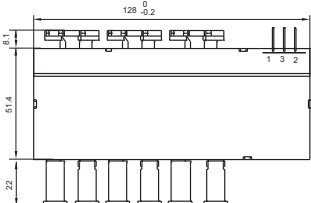
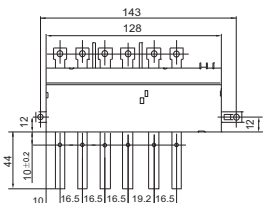
Type	HFE17	HFE35	HFE36
Appearance			
Dimensions(L x W x H) mm	97.6 x 73.2 x 29.5	128.0 x 30.5 x 34.5	128.0 x 30.5 x 34.5
Features	<ul style="list-style-type: none"> <li>• Latching relay</li> <li>• 200A switching capability</li> <li>• According to ANSI C 12.1 (Carrying: 12kA current / 66.7ms; 7kA peak current/100ms )</li> <li>• Switching power up to 55.4kVA</li> </ul>	<ul style="list-style-type: none"> <li>• 3-phases latching relay</li> <li>• 100A switching capability</li> <li>• According to the fault current and electrical life test of IEC 62055-31: UC1, UC2, UC3</li> </ul>	<ul style="list-style-type: none"> <li>• 3-phases latching relay</li> <li>• 100A switching capability</li> <li>• Heavy load up to 22.2kVA</li> <li>• 4kV dielectric strength (between coil and contacts)</li> </ul>
<b>Contact Ratings</b>			
Contact Form	2A,2B	3SH, 3SD	3SH, 3SD
Contact Material	AgSnO <sub>2</sub>	AgSnO <sub>2</sub>	AgSnO <sub>2</sub>
Max. Rated Switching Current (Resistive load)			
Max. Switching Voltage	440VAC	440VAC	440VAC
Max. Switching Power	55400VA / 5600W	22000VA	23000VA
Rated Load (Resistive load)	200A 277VAC / 28VDC	100A 220VAC	100A 230VAC
<b>Coil Ratings</b>			
Rated Voltage	12VDC to 48VDC	6VDC to 48VDC	6VDC to 48VDC
Nominal Operating Power	12W, 24W	8W, 16W	8W, 16W
<b>Specifications</b>			
Insulation Resistance	1000MΩ	1000MΩ	1000MΩ
Dielectric Strength (Between coil and contacts)	4000VAC	4000VAC	4000VAC
Ambient Temperature	-40°C to 85°C	-40°C to 75°C	-40°C to 85°C
Operate / Release Time max.	20ms / 20ms	30ms / 30ms	30ms / 30ms
Mechanical Endurance min.	5 x 10 <sup>4</sup> OPS	1 x 10 <sup>5</sup> OPS	1 x 10 <sup>5</sup> OPS
Electrical Endurance min.	6000 OPS	10000 OPS	5000 OPS
Layout (Bottom view)			
Terminal Type	QC	QC	QC
Approved Standards			
File No.			
Cross Reference	GRUNER: 740		

Note: Specification and dimensions in this catalog are subject to change without notice.



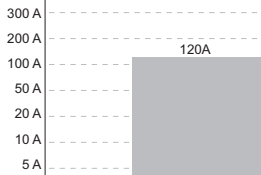
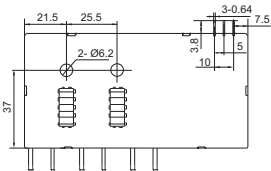



## LATCHING RELAY SELECTION CHART

Type	HFE23		
Appearance			
Dimensions(L x W x H) mm	115.0 x 54.0 x 24.0		
Features	<ul style="list-style-type: none"> <li>• 3-phases latching relay</li> <li>• 120A switching capability</li> <li>• According to IEC62055: UC1, UC2, UC2</li> <li>• 4kV dielectric strength (between coil and contacts)</li> </ul>		
<b>Contact Ratings</b>			
Contact Form	3A, 3B, 3SH, 3SD		
Contact Material	AgSnO <sub>2</sub>		
Max. Rated Switching Current (Resistive load)	 <p>300 A 200 A 100 A 50 A 20 A 10 A 5 A</p>		
Max. Switching Voltage	440VAC		
Max. Switching Power	27600VA		
Rated Load (Resistive load)	120A 230VAC		
<b>Coil Ratings</b>			
Rated Voltage	6VDC to 48VDC		
Nominal Operating Power	5W, 10W		
<b>Specifications</b>			
Insulation Resistance	1000MΩ		
Dielectric Strength (Between coil and contacts)	4000VAC		
Ambient Temperature	-40°C to 85°C		
Operate / Release Time max.	20ms / 20ms		
Mechanical Endurance min.	1 x 10 <sup>5</sup> OPS		
Electrical Endurance min.	10000 OPS		
Layout (Bottom view)			
Terminal Type	QC		
Approved Standards			
File No.			
Cross Reference	GRUNER: 733		

Note: Specification and dimensions in this catalog are subject to change without notice.



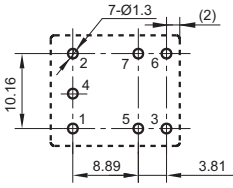
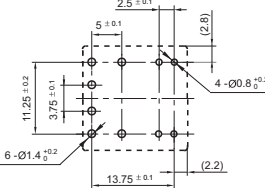
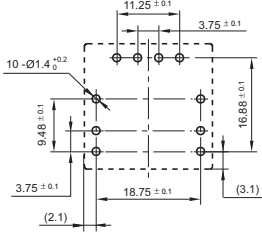

## AUTOMOTIVE RELAY & MODULE SELECTION CHART

Type	HFKM	HFKD	HFKDV
Appearance			
Dimensions(L x W x H) mm	17.5 x 15.0 x 19.5 (Plastic sealed)	17.5 x 16.9 x 13.2	22.8 x 22.3 x 20.4
Features	<ul style="list-style-type: none"> <li>Six different contact arrangements</li> <li>Unenclosed and plastic sealed types available</li> <li>PCB terminals</li> </ul>	<ul style="list-style-type: none"> <li>Micro miniature</li> <li>Silent double relay available</li> <li>Change-over contact version</li> </ul>	<ul style="list-style-type: none"> <li>Micro miniature</li> <li>Silent type</li> <li>Double relay</li> <li>Change-over contact version</li> </ul>
<b>Contact Ratings</b>			
Contact Form	1A, 1B, 1C, 1U, 1V, 1W	2C	2C
Contact Material	AgSnO <sub>2</sub>	AgSnO <sub>2</sub>	AgSnO <sub>2</sub>
Max. Rated Switching Current			
Max. Switching Voltage		16VDC	40VDC
Rated Load (Resistive load)	1A: 15A 13.5VDC 1B: 10A 13.5VDC 1C: NO/NC 15A/10A 13.5VDC 1U: 2 x 7A 13.5VDC 1V: 2 x 5A 13.5VDC 1W: NO/NC 2 x 7A/2 x 5A 13.5VDC	20A 13.5VDC	20A 13.5VDC
<b>Coil Ratings</b>			
Rated Voltage	6, 12VDC	12VDC	12VDC
Nominal Operating Power	1.1W	0.56W, 0.81W	0.56W, 0.81W
<b>Specifications</b>			
Insulation Resistance	100MΩ	100MΩ	100MΩ
Dielectric Strength (Between coil and contacts)	500VAC	500VAC	500VAC
Ambient Temperature	-40°C to 85°C	-40°C to 85°C	-40°C to 85°C
Operate / Release Time max.	10ms / 10ms	10ms / 10ms	10ms / 10ms
Mechanical Endurance min.	1 x 10 <sup>7</sup> OPS	1 x 10 <sup>7</sup> OPS	1 x 10 <sup>7</sup> OPS
Electrical Endurance min.	2 x 10 <sup>5</sup> OPS	2 x 10 <sup>5</sup> OPS	2 x 10 <sup>5</sup> OPS
Layout (Bottom view)			
Terminal Type	PCB	PCB	PCB
Cross Reference	TE: V23072	TE: V23084-C	

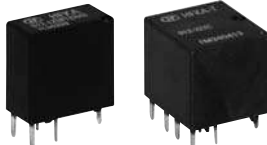

**Note:** Specification and dimensions in this catalog are subject to change without notice.

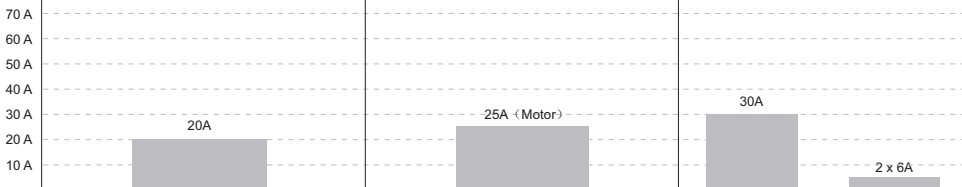
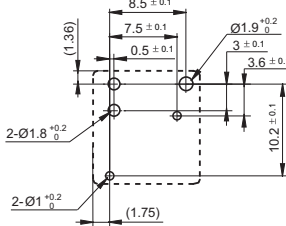
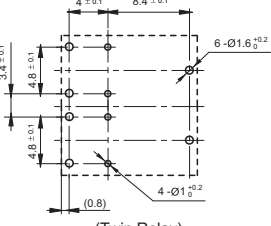
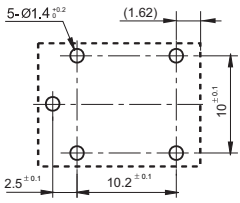
## AUTOMOTIVE RELAY & MODULE SELECTION CHART

Type	HFKC / HFKC-T	HFKA / HFKA-T	HFKW/HFKW-SH	
Appearance				
Dimensions(L x W x H) mm	12.0 x 12.9 x 9.9	14.0 x 15.4 x 13.5 (Standard Twin)	15.7 x 12.5 x 14.0	
Features	<ul style="list-style-type: none"> <li>• Subminiature relay</li> <li>• 4g weight (Single relay)</li> <li>• Extended temp. range up to 105°C</li> <li>• The reflow soldering version (open vent hole) available (HFKC-T)</li> </ul>	<ul style="list-style-type: none"> <li>• 25A motor lock load</li> <li>• Extremely small relay</li> <li>• Single and twin version available</li> <li>• Coil wire insulation class H (at 180°C)</li> <li>• HFKA-T (reflow soldering version) available</li> </ul>	<ul style="list-style-type: none"> <li>• Small size</li> <li>• High current contact capacity(HFKW: carrying current 35A/10min, 25A/1h)</li> <li>• Double NO contacts (HFKW-SH)</li> <li>• Improved heat resistance</li> <li>• Reflow soldering version available</li> </ul>	
<b>Contact Ratings</b>				
Contact Form	1A, 1C	1C, 2C	1A, 1C	1U
Contact Material	AgSnO <sub>2</sub>		AgSnO <sub>2</sub>	
Max. Rated Switching Current				
Max. Switching Voltage	16VDC	16VDC	30VDC	
Rated Load (Resistive load)	20A 13.5VDC	Motor: 25A 13.5VDC	20A 13.5VDC 30A 13.5VDC	2x6A 13.5VDC
<b>Coil Ratings</b>				
Rated Voltage	6, 10, 12VDC	12VDC	6, 9, 10, 12VDC	
Nominal Operating Power	0.55W, 0.8W	0.64W, 0.8W	0.6W	1.0W
<b>Specifications</b>				
Insulation Resistance	100MΩ	100MΩ	100MΩ	
Dielectric Strength (Between coil and contacts)	500VAC		500VAC	
Ambient Temperature	-40°C to 105°C	HFKA: -40°C to 85°C HFKA-T: -40°C to 105°C	-40°C to 85°C	
Operate / Release Time max.	10ms / 10ms	10ms / 10ms	10ms / 5ms	
Mechanical Endurance min.	1 x 10 <sup>7</sup> OPS	1 x 10 <sup>6</sup> OPS	1 x 10 <sup>7</sup> OPS	
Electrical Endurance min.	3 x 10 <sup>5</sup> OPS (at 20A 13.5VDC)	1 x 10 <sup>5</sup> OPS	HFKW: 2x10 <sup>5</sup> OPS(20A 13.5VDC) 1x10 <sup>5</sup> OPS(30A 13.5VDC) HFKW-SH: 2 x10 <sup>5</sup> OPS(2x6A 13.5VDC)	
Layout (Bottom view)		 (Twin Relay)		
Terminal Type	PCB		PCB	
Cross Reference	PANASONIC: CP TE: V23086	Single Relay: OMRON: G8N-1 Twin Relay: OMRON: G8NW	OMRON: G8QN PANASONIC: JJM FUJITSU: FBR51/52	

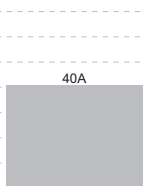
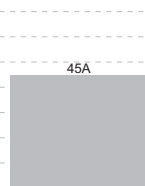
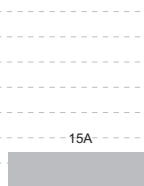
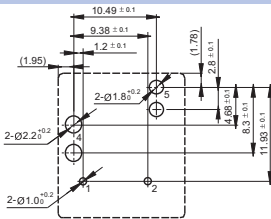
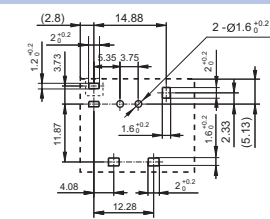
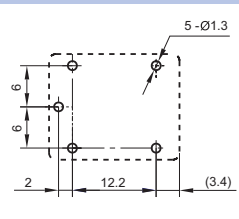

**Note:** Specification and dimensions in this catalog are subject to change without notice.

## AUTOMOTIVE RELAY & MODULE SELECTION CHART

Type	HFKT/HFKT-T	HF KP	HF3FF-M
Appearance			
Dimensions(L x W x H) mm	18.3 x 16.0 x 15.9	26.5 x 22.0 x 22.3 (Plastic sealed)	19.0 x 15.2 x 15.5
Features	<ul style="list-style-type: none"> <li>Max.continuous current 40A</li> <li>Max.making current 200A</li> <li>Extended temp. range up to 105°C</li> <li>With highly established reliability</li> <li>Strong resistance ability to shock &amp; vibration</li> <li>Reflow soldering version available</li> </ul>	<ul style="list-style-type: none"> <li>45A switching capability</li> <li>PCB terminals</li> <li>Two pin layout choices</li> <li>1 Form A &amp; 1 Form C contact arrangement</li> <li>Unenclosed and plastic sealed types available</li> </ul>	<ul style="list-style-type: none"> <li>15A switching capability</li> <li>Subminiature, standard PCB layout</li> <li>1 Form A and 1 Form C</li> <li>Plastic sealed and flux proofed types available</li> </ul>
<b>Contact Ratings</b>			
Contact Form	1A	1A, 1C	1A, 1C
Contact Material	AgSnO <sub>2</sub>	AgSnO <sub>2</sub>	AgSnO <sub>2</sub>
Max. Rated Switching Current			
Max. Switching Voltage	16VDC	75VDC	30VDC
Rated Load (Resistive load)	40A 13.5VDC	1A: 45A 13.5VDC 1C: NO/NC 45A/30A 13.5VDC	1A: 15A 13.5VDC 1C: NO: 15A 13.5VDC NC: 5A 13.5VDC
<b>Coil Ratings</b>			
Rated Voltage	10, 12VDC	6, 12, 24VDC	9VDC to 24VDC
Nominal Operating Power	0.818W, 0.833W	1.2W, 1.6W, 1.9W	0.45W, 0.64W, 0.80W
<b>Specifications</b>			
Insulation Resistance	100MΩ	500MΩ	100MΩ
Dielectric Strength (Between coil and contacts)	500VAC	500VAC	1500VAC
Ambient Temperature	-40°C to 105°C	-40°C to 125°C	-40°C to 85°C
Operate / Release Time max.	10ms / 5ms	10ms / 10ms	10ms / 10ms
Mechanical Endurance min.	2 x 10 <sup>6</sup> OPS	1 x 10 <sup>7</sup> OPS	1 x 10 <sup>7</sup> OPS
Electrical Endurance min.	1 x 10 <sup>5</sup> OPS	1 x 10 <sup>5</sup> OPS	1 x 10 <sup>5</sup> OPS
Layout (Bottom view)			
Terminal Type	PCB	PCB	PCB
Cross Reference	PANASONIC: CN-H/ACTC TE: V23201 FUJITSU: FBR-59	OMRON: G8PE TE: V23076/V23133 FUJITSU: FRL274	OMRON: G8SN PANASONIC: JSM SCHRACK: T72N

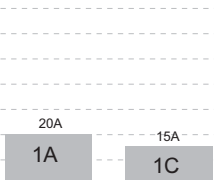
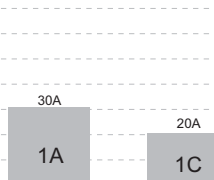
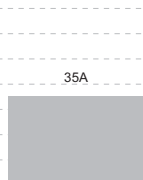
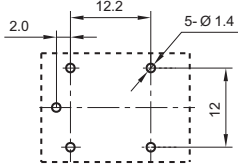
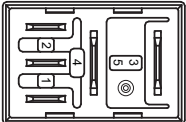
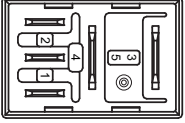

**Note:** Specification and dimensions in this catalog are subject to change without notice.

## AUTOMOTIVE RELAY & MODULE SELECTION CHART

Type	HFKE	HFV6	HFV6-G
Appearance			
Dimensions(L x W x H) mm	22.5 x 16.5 x 16.5	23.0 x 15.5 x 25.4	23.0 x 15.5 x 25.4
Features	<ul style="list-style-type: none"> <li>20A switching capability</li> <li>Ambient temperature : -40°C to 85°C</li> <li>1 Form C and 1 Form A configurations available</li> <li>Plastic sealed and flux proofed type available</li> </ul>	<ul style="list-style-type: none"> <li>30A switching capability</li> <li>Ambient temp. range up to 125°C</li> <li>1 Form A &amp; 1 Form C contact arrangement</li> <li>Plastic sealed and dust protected types available</li> </ul>	<ul style="list-style-type: none"> <li>Ambient temp. range up to 125°C</li> <li>1 Form A &amp; 1 Form C contact arrangement</li> <li>Plastic sealed and dust protected types available</li> </ul>
<b>Contact Ratings</b>			
Contact Form	1A, 1C	1A, 1C	1A, 1C
Contact Material	AgNi	AgSnO <sub>2</sub>	AgSnO <sub>2</sub>
Max. Rated Switching Current			
Max. Switching Voltage	14VDC	27VDC	16VDC
Rated Load (Resistive load)	1A: 20A 13.5VDC 1C: NO: 15A 13.5VDC NC: 12A 13.5VDC	1A: 30A 13.5VDC 20A 27VDC 1C: NO/NC 20A/10A 13.5VDC 20A/10A 27VDC	1A: 35A 13.5VDC 1C: NO/NC 35A/20A 13.5VDC
<b>Coil Ratings</b>			
Rated Voltage	3VDC to 48VDC	12, 24VDC	12VDC
Nominal Operating Power	0.64W	1.2W, 1.3W, 1.4W, 1.6W, 1.8W	1.16W, 1.37W
<b>Specifications</b>			
Insulation Resistance	100MΩ	100MΩ	100MΩ
Dielectric Strength (Between coil and contacts)	1500VAC	500VAC	500VAC
Ambient Temperature	-40°C to 85°C	-40°C to 125°C	-40°C to 125°C
Operate / Release Time max.	10ms / 5ms	10ms / 10ms	10ms / 10ms
Mechanical Endurance min.	1 x 10 <sup>7</sup> OPS	1 x 10 <sup>7</sup> OPS	1 x 10 <sup>7</sup> OPS
Electrical Endurance min.	1 x 10 <sup>5</sup> OPS	1 x 10 <sup>5</sup> OPS	1 x 10 <sup>5</sup> OPS
Layout (Bottom view)			
Terminal Type	PCB	QC, PCB	QC
Cross Reference	FUJITSU: FBR161/166/FTR-P1	OMRON: G8HN PANASONIC: CM TE: V23074-A	OMRON: G8HE TE: V23074-H

**Note:** Specification and dimensions in this catalog are subject to change without notice.

## AUTOMOTIVE RELAY & MODULE SELECTION CHART

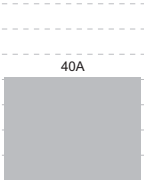
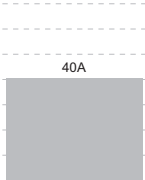
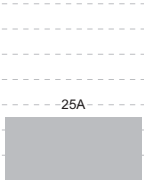
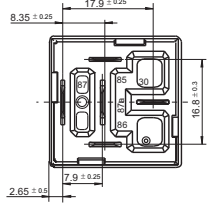
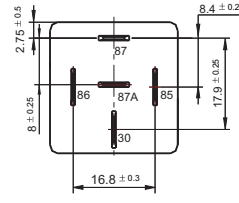
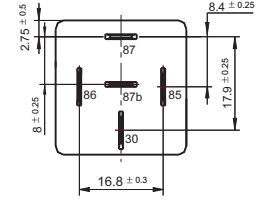
Type	HFV15	HFV4	HFV4-SH
Appearance			
Dimensions(L x W x H) mm	26.0 x 26.0 x 22.7	26.2 x 26.2 x 23.7	26.2 x 26.2 x 23.7
Features	<ul style="list-style-type: none"> <li>40A switching capability</li> <li>1Form A &amp; 1 Form C contact arrangement</li> <li>RoHS &amp; ELV compliant</li> </ul>	<ul style="list-style-type: none"> <li>40A switching capability</li> <li>Various mounting terminations available</li> <li>1 Form A &amp; 1 Form C contact arrangement</li> <li>Plastic sealed and dust protected types available</li> </ul>	<ul style="list-style-type: none"> <li>2x25A switching capability</li> <li>Continuous current of 25A per group contacts at 85°C</li> <li>Double NO contacts</li> <li>Various mounting terminations available</li> <li>Dust protected type available</li> </ul>
<b>Contact Ratings</b>			
Contact Form	1A,1C	1A, 1C	1U
Contact Material	AgSnO <sub>2</sub>	AgSnO <sub>2</sub>	AgSnO <sub>2</sub>
Max. Rated Switching Current			
Max. Switching Voltage	80VDC		
Rated Load (Resistive load)	1A: 40A 13.5VDC 1C: NO 40A 13.5VDC NC 30A 13.5VDC	1A: 40A 13.5VDC 20A 27VDC 1C: NO/NC 40A/30A 13.5VDC 20A/10A 27VDC	25A 13.5VDC 10A 27VDC
<b>Coil Ratings</b>			
Rated Voltage	12VDC	6, 12, 24VDC	12, 24VDC
Nominal Operating Power	1.6W, 1.8W	1.6W, 1.7W, 1.8W, 1.9W	1.6W, 1.8W
<b>Specifications</b>			
Insulation Resistance	100MΩ	100MΩ	100MΩ
Dielectric Strength (Between coil and contacts)	500VAC	500VAC	500VAC
Ambient Temperature	-40°C to 125°C	-40°C to 125°C	-40°C to 125°C
Operate / Release Time max.	10ms / 10ms	7ms / 5ms	10ms / 10ms
Mechanical Endurance min.	1 x 10 <sup>6</sup> OPS	1 x 10 <sup>6</sup> OPS	1 x 10 <sup>6</sup> OPS
Electrical Endurance min.	1 x 10 <sup>5</sup> OPS	1 x 10 <sup>5</sup> OPS	1 x 10 <sup>5</sup> OPS
Layout (Bottom view)			
Terminal Type	QC	QC, PCB	QC
Cross Reference	PANASONIC: CB OMRON: G8JN TE: V23134-A/B, V23136 SONGCHUAN: 896/896H	OMRON: G8JN PANASONIC: CB TE: V23134-A/B, V23234-A/B, V23136-A/B, VF4A	TE: V23134-M

**Note:** Specification and dimensions in this catalog are subject to change without notice.

## AUTOMOTIVE RELAY & MODULE SELECTION CHART

Type	HFV4N	HFV7A	HFV16
Appearance			
Dimensions(L x W x H) mm	26.2 x 26.2 x 23.7	26.5 x 26.5 x 25.2	26.0 x 26.0 x 22.7
Features	<ul style="list-style-type: none"> <li>40A switching capability</li> <li>Various mounting terminations available</li> <li>1 Form A (2x87) contact arrangement</li> </ul>	<ul style="list-style-type: none"> <li>50A switching capability</li> <li>Extended temp. range up to 125°C</li> <li>With transient suppression resistor available</li> <li>1 Form A &amp; 1 Form C contact arrangement</li> <li>Plastic sealed and dust protected types available</li> </ul>	<ul style="list-style-type: none"> <li>70A switching capability</li> <li>Extended temp. range up to 125°C</li> <li>1Form A contact arrangement</li> </ul>

### Contact Ratings

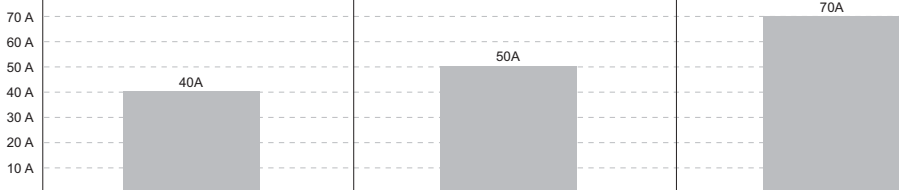
Contact Form	1A	1A,1C	1A
Contact Material	AgSnO <sub>2</sub>	AgSnO <sub>2</sub>	AgSnO <sub>2</sub>
Max. Rated Switching Current			
Max. Switching Voltage	80VDC	50VDC	50VDC
Rated Load (Resistive load)	40A 13.5VDC 20A 27VDC	1A: 50A 13.5VDC 1C: NO/NC 50A/30A 13.5VDC	70A 13.5VDC

### Coil Ratings

Rated Voltage	12, 24VDC	6, 12, 24VDC	12VDC
Nominal Operating Power	1.6W, 1.7W, 1.9W	1.6W, 1.8W, 2.0W, 2.2W	1.6W, 1.8W

### Specifications

Insulation Resistance	100MΩ	100MΩ	100MΩ
Dielectric Strength (Between coil and contacts)	500VAC	500VAC	500VAC
Ambient Temperature	-40°C to 125°C	-40°C to 125°C	-40°C to 125°C
Operate / Release Time max.	7ms / 5ms	10ms / 7ms	10ms / 10ms
Mechanical Endurance min.	1 x 10 <sup>6</sup> OPS	1 x 10 <sup>7</sup> OPS	1 x 10 <sup>6</sup> OPS
Electrical Endurance min.	1 x 10 <sup>5</sup> OPS	1 x 10 <sup>5</sup> OPS	1 x 10 <sup>5</sup> OPS

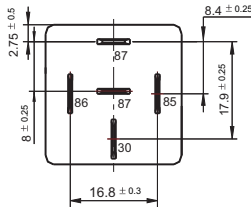
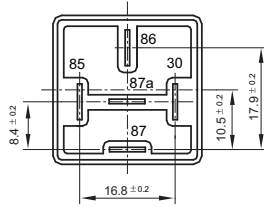
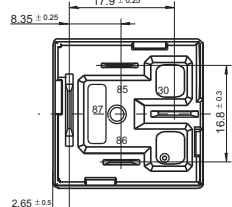



Layout (Bottom view)			
----------------------	---	--	---

Terminal Type	QC	QC	QC
---------------	----	----	----

Cross Reference	TE: V23134-C/V23234-C	PANASONIC: CB OMRON: G8JR SONGCHUAN: 897	
-----------------	-----------------------	--	--

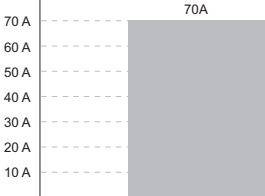

**Note:** Specification and dimensions in this catalog are subject to change without notice.

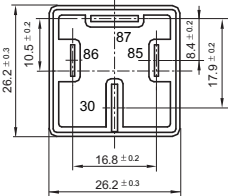
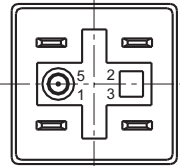
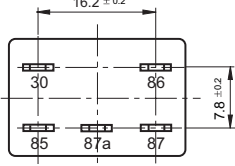
## AUTOMOTIVE RELAY & MODULE SELECTION CHART

Type	HFV7	HFV11	HFV9
Appearance			
Dimensions(L x W x H) mm	26.5 x 26.5 x 25.2	15.6 x 15.2 x 16.4	22.5 x 15.0 x 25.0
Features	<ul style="list-style-type: none"> <li>• 70A switching capability</li> <li>• Extended temp. range up to 125°C</li> <li>• With transient suppression resistor available</li> <li>• 1 Form A contact arrangement</li> <li>• Plastic sealed and dust protected types available</li> </ul>	<ul style="list-style-type: none"> <li>• Miniaturized package</li> <li>• Extended temp. range up to 125°C</li> <li>• 2.8mm QC terminals</li> <li>• 1 Form A contact arrangement</li> </ul>	<ul style="list-style-type: none"> <li>• Extended temp. range up to 125°C</li> <li>• 2.8mm QC terminals</li> <li>• 1 Form A &amp; 1 Form C contact arrangement</li> </ul>
<b>Contact Ratings</b>			
Contact Form	1A	1A	1A, 1C
Contact Material	AgSnO <sub>2</sub>	AgSnO <sub>2</sub>	AgSnO <sub>2</sub>
Max. Rated Switching Current			
Max. Switching Voltage	50VDC		
Rated Load (Resistive load)	70A 13.5VDC 40A 27VDC	20A 13.5VDC	1A: 20A 13.5VDC 20A 27VDC 1C: NO/NC 20A/10A 13.5VDC 20A/10A 27VDC
<b>Coil Ratings</b>			
Rated Voltage	6, 12, 24VDC	12VDC	12, 24VDC
Nominal Operating Power	1.6W, 1.8W, 2.0W, 2.2W	0.95W, 1.1W	1.3W, 1.5W, 1.6W, 1.8W
<b>Specifications</b>			
Insulation Resistance	100MΩ	100MΩ	100MΩ
Dielectric Strength (Between coil and contacts)	500VAC	500VAC	500VAC
Ambient Temperature	-40°C to 125°C	-40°C to 125°C	-40°C to 125°C
Operate / Release Time max.	10ms / 7ms	10ms / 10ms	10ms / 10ms
Mechanical Endurance min.	1 x 10 <sup>7</sup> OPS	1 x 10 <sup>5</sup> OPS	1 x 10 <sup>7</sup> OPS
Electrical Endurance min.	1 x 10 <sup>5</sup> OPS	1 x 10 <sup>5</sup> OPS	1 x 10 <sup>5</sup> OPS
Layout (Bottom view)			
Terminal Type	QC, PCB	QC	QC
Cross Reference	OMRON: G8JR PANASONIC: CB TE: V23134-J/V23136-J	OMRON: G8VA/G8VL TE: VH28	OMRON: G8V TE: VJ28

**Note:** Specification and dimensions in this catalog are subject to change without notice.



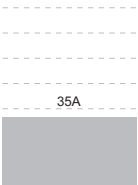
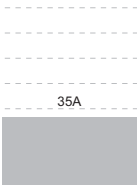
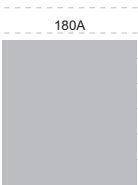
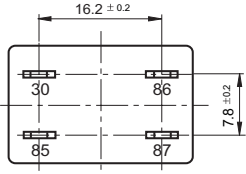
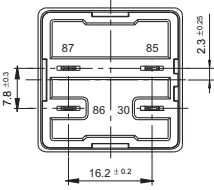
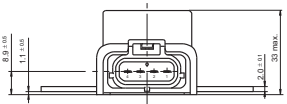

## AUTOMOTIVE RELAY & MODULE SELECTION CHART

Type	HFV9-G	HFV28	HFV12
Appearance			
Dimensions(L x W x H) mm	22.5 x 15.0 x 25.0	28.0 x 28.0 x 24.5	86.0 x 83.0 x 33.0
Features	<ul style="list-style-type: none"> <li>Extended temp. range up to 125°C</li> <li>2.8mm QC terminals</li> <li>1 Form A &amp; 1 Form C contact arrangement</li> </ul>	<ul style="list-style-type: none"> <li>Extended temp. range up to 125°C</li> <li>2.8mm QC terminals</li> <li>1 Form A &amp; 1 Form C contact arrangement</li> </ul>	<ul style="list-style-type: none"> <li>Battery disconnection relay (power supply management)</li> <li>Dual coil latching type</li> <li>Contact continuous load current reach 190A at 85°C</li> <li>Load terminal: Screw connector (M8 bolt)</li> <li>Coil terminal: 4-pin connector (AMP 0.070 series)</li> </ul>
<b>Contact Ratings</b>			
Contact Form	1A, 1C	1A, 1C	1A
Contact Material	AgSnO <sub>2</sub>	AgSnO <sub>2</sub>	AgSnO <sub>2</sub>
Max. Rated Switching Current			
Max. Switching Voltage			16VDC
Rated Load (Resistive load)	1A: 35A 13.5VDC 1C: NO: 35A 13.5VDC NC: 20A 13.5VDC	1A: 35A 13.5VDC 1C: NO: 35A 13.5VDC NC: 20A 13.5VDC	Inductive: 180A 14VDC 100A 14VDC
<b>Coil Ratings</b>			
Rated Voltage	12VDC	12, 24VDC	12VDC
Nominal Operating Power	1.2W, 1.4W	1.6W, 1.8W	
<b>Specifications</b>			
Insulation Resistance	100MΩ	100MΩ	100MΩ
Dielectric Strength (Between coil and contacts)	500VAC	500VAC	500VAC
Ambient Temperature	-40°C to 125°C	-40°C to 125°C	-40°C to 120°C
Operate / Release Time max.	10ms / 10ms	10ms / 10ms	20ms / 20ms
Mechanical Endurance min.	1 x 10 <sup>7</sup> OPS	1 x 10 <sup>7</sup> OPS	2 x 10 <sup>5</sup> OPS
Electrical Endurance min.	1 x 10 <sup>5</sup> OPS	1 x 10 <sup>5</sup> OPS	5 x 10 <sup>4</sup> OPS (at 100A 14VDC) 1.5 x 10 <sup>4</sup> OPS (at 180A 14VDC)
Layout (Bottom view)			
Terminal Type	QC	QC	QC & Screw
Cross Reference	OMRON: G8V-RH TE: VJ28	OMRON: G8W TE: VF28	TE: V23130/BDS-A HELLA: BDR (with different layout)

**Note:** Specification and dimensions in this catalog are subject to change without notice.





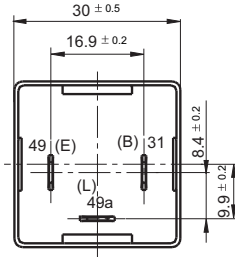
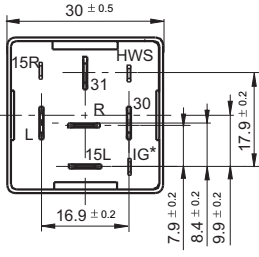
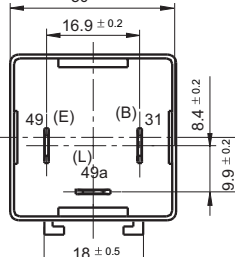
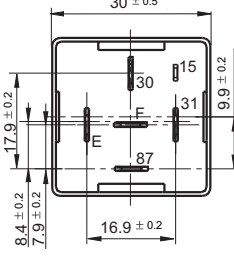
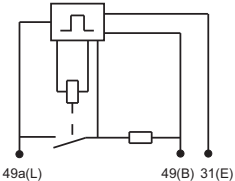
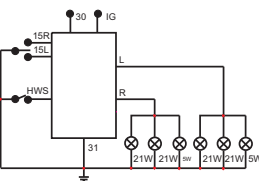
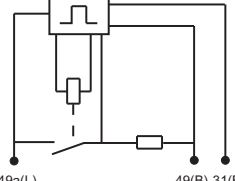
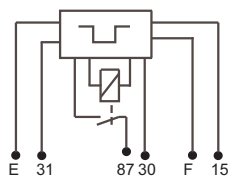

# AUTOMOTIVE RELAY & MODULE SELECTION CHART

Type	HF3501 (Flasher)	HF3506/HF3506A (Flasher)	HF3508 (Flasher)	HF3505/HF3505A (Fog-Lamp controller)
Appearance				
Dimensions (L x W x H) mm	30.0 x 30.0 x 40.0	30.0 x 30.0 x 30.0	30.0 x 30.0 x 30.0	30.0 x 30.0 x 30.0
Features	<ul style="list-style-type: none"> <li>• Special integrate circuit, good performance</li> <li>• Special high-performance contacts, ultra-long life</li> <li>• Surface mounting technology, advanced craftwork</li> <li>• Solid base design, stable structure]</li> <li>• Ingress protection: IP52</li> </ul>	<ul style="list-style-type: none"> <li>• Special integrate circuit, good performance</li> <li>• Special high-performance contacts, ultra-long life</li> <li>• Surface mounting technology, advanced craftwork</li> <li>• Solid base design, stable structure]</li> <li>• Ingress protection: IP52</li> </ul>	<ul style="list-style-type: none"> <li>• Special integrate circuit, good performance</li> <li>• Special high-performance contacts, ultra-long life</li> <li>• Surface mounting technology, advanced craftwork</li> <li>• Solid base design, stable structure]</li> <li>• Ingress protection: IP52</li> </ul>	<ul style="list-style-type: none"> <li>• Solid base design, stable structure</li> <li>• Maturing circuit, stable and reliable performances</li> </ul>
Ambient Temperature	-40°C to 85°C	-40°C to 85°C	-40°C to 85°C	-40°C to 85°C
Rated Load	Lamp: 2×21W + 5W 4×21W + 2×5W	Lamp: 2×21W+5W+2W 4×21W+2×5W+2×2W	Lamp: 2×21W + 5W 4×21W + 2×5W	Lamp: 5A Resistive: 15A
Nominal Voltage	12VDC, 24VDC	12VDC	12VDC	12VDC
Intermittent Time	---	---	---	---
Wiping Time	---	---	---	---
Flashing Frequency	(60 to 110)OPS/min	(60 to 110)OPS/min	(60 to 10)OPS/min	---
Lamp Failure Flashing Frequency	(140 to 230)OPS/min	(140 to 230)OPS/min	(140 to 230)OPS/min	---
Delaying Time	---	---	---	---
Energizing Ratio	30% to 70%	30% to 70%	30% to 70%	---
Electrical Endurance min.	Turning 15s on/15s off 12V 1000h Hazard continuously 12V 360h Turning 15s on/15s off 24V 400h Hazard continuously 24V 200h	1000h(15s on,15s off, rate load) 360h(continuous, alarming)	Turning 15s on/15s off 12V 1000h Hazard continuously 12V 360h	5 x 10 <sup>4</sup> OPS
Weight	40g	35g	30g	30g
Layout (Bottom view)	 <p><b>Note:</b> Marks on B,L,E terminals stand for reverse polarity.</p>	 <p><b>Note:</b> IG terminal with startup control function; There is no IG terminal for HF3506A.</p>	 <p><b>Note:</b> Marks on B,L,E terminals stand for reverse polarity.</p>	 <p><b>Note:</b> Marks on 1 to 8 terminals stand for reset function.</p>
Wiring Diagram				

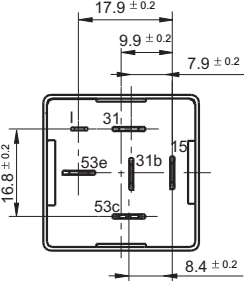
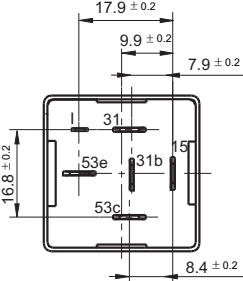
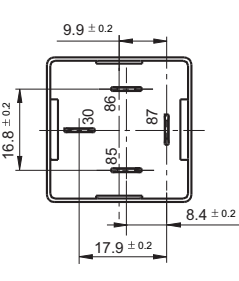
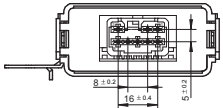
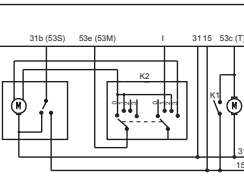
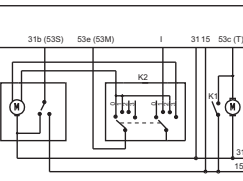
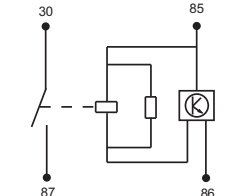
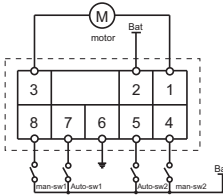

**Note:** The above product with brackets are available; PCB layout differences for different specifications . please see each data sheets. All the specifications and dimensions are subject to change without notice.

## AUTOMOTIVE RELAY & MODULE SELECTION CHART

Type	HF3504 (Intermittent Wiper Controller)	HF3507 (Intermittent Wiper Controller)	HF3503 (Delaying Relay)	HF3605 (Window Lifter Controller)
Appearance				
Dimensions (L x W x H) mm	30.0 x 30.0 x 30.0	30.0 x 30.0 x 40.0	30.0 x 30.0 x 30.0	87.0 x 29.0 x 82.0
Features	<ul style="list-style-type: none"> <li>Maturing circuit, stable and reliable</li> <li>Solid base design, stable structure</li> <li>Wiper automatic positioning implementation</li> </ul>	<ul style="list-style-type: none"> <li>Maturing circuit, stable and reliable</li> <li>Solid base design, stable structure</li> <li>Wiper automatic positioning implementation</li> </ul>	<ul style="list-style-type: none"> <li>Solid base design, stable structure</li> <li>Maturing circuit, stable and reliable performances</li> <li>Surface mounting technology, advanced craftwork</li> </ul>	<ul style="list-style-type: none"> <li>special IC with excellent performance</li> <li>with manual &amp; automatic up-downfunction</li> <li>with overload protection under the above function</li> <li>connect with DJ7081-2.3-20 easy to mount</li> </ul>
Ambient Temperature	-40°C to 85°C	-40°C to 85°C	-40°C to 85°C	-40°C to 85°C
Rated Load	Wiper: 50W 12VDC 80W 24VDC	Wiper: 50W 12VDC 80W 24VDC	Resistive: 15A 13.5VDC 20A 24VDC 40A 13.5VDC	Simulation Motor Load: 10A 12VDC
Nominal Voltage	12VDC, 24VDC	12VDC, 24VDC	12VDC, 24VDC	12VDC
Intermittent Time	5.5s ± 1.5s	5.5s ± 1.5s	---	---
Wiping Time	3.5s + 2.5s	3.5s + 2.5s	---	---
Flashing Frequency	---	---	---	---
Lamp Failure Flashing Frequency	---	---	---	---
Delaying Time	---	---	2s, 10s	---
Energizing Ratio	---	---	---	---
Electrical Endurance min.	1 x 10 <sup>5</sup> OPS	1 x 10 <sup>5</sup> OPS	1 x 10 <sup>5</sup> OPS	5 x 10 <sup>4</sup> OPS
Weight	30g	30g	35g	82g
Layout (Bottom view)				
Wiring Diagram				

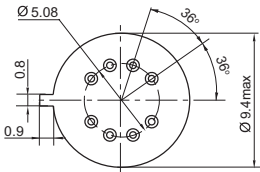
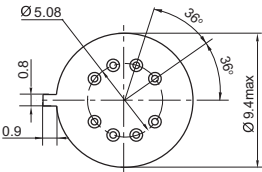
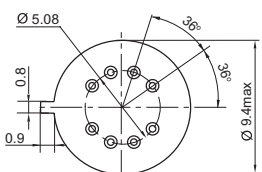

**Note:** The above product with brackets are available; PCB layout differences for different specifications .please see each data sheets. All the specifications and dimensions are subject to change without notice.

## HERMETICALLY SEALED RELAY SELECTION CHART

Type	HF9110	HF9111	HF9112
Appearance			
Dimensions(L x W x H) mm	Ø 8.51 x 7.11	Ø 8.51 x 7.11	Ø 8.51 x 7.11
Features	<ul style="list-style-type: none"> <li>Failure rate can be Level M</li> <li>Approved by GJB65B</li> <li>High ambient applicability</li> <li>All metal welded construction</li> <li>Fusing soldering and marked by laser</li> </ul>	<ul style="list-style-type: none"> <li>Ambient temperature can be 180°C</li> <li>High ambient applicability</li> <li>All metal welded construction</li> <li>Hermetically welded and marked by laser</li> </ul>	<ul style="list-style-type: none"> <li>Sensitive type</li> <li>Coil power can be 0.25W</li> <li>High ambient applicability</li> <li>All metal welded construction</li> <li>Fusing soldering and marked by laser</li> <li>Internal diode for coil transient suppression protection</li> </ul>
<b>Contact Ratings</b>			
Contact Form	2C	2C	2C
Max.Rated Switching Current	1A	0.5A	0.5A
Max.Switching Voltage	28Vd.c. / 115Va.c.(400Hz)	28Vd.c.	28Vd.c.
Min.Rated Switching Current	50µA	50µA	50µA
Min.Switching Voltage	50mVd.c.	50 mVd.c.	50mVd.c.
Rated Load (Resistive load)	1A 28Vd.c.	0.5A 28Vd.c.	0.5A 28Vd.c.
<b>Coil Ratings</b>			
Nominal Voltage	5Vd.c. to 27Vd.c.	12, 27Vd.c.	7Vd.c.
Nominal Operating Power	0.5W	0.5W	0.25W
<b>Ambient Adaptability</b>			
Ambient Temperature	-65°C to 125°C	-65°C to 180°C	-65°C to 125°C
Vibration	294m/s <sup>2</sup> 10Hz to 3000Hz	294m/s <sup>2</sup> 10Hz to 3000Hz	294m/s <sup>2</sup> 10Hz to 3000Hz
Shock	735m/s <sup>2</sup>	735m/s <sup>2</sup>	735m/s <sup>2</sup>
Steady-state acceleration	490m/s <sup>2</sup>	490m/s <sup>2</sup>	490m/s <sup>2</sup>
<b>Specifications</b>			
Insulation Resistance min.	10000MΩ	10000MΩ	10000MΩ
Dielectric Strength min.	500Vr.m.s	500Vr.m.s	500Vr.m.s
Operate/Release Time max.	2ms / 1.5ms	2ms / 2ms	2ms / 4ms
Electrical Endurance min.	1 x 10 <sup>5</sup> OPS	1 x 10 <sup>5</sup> OPS	1 x 10 <sup>5</sup> OPS
Leakage Rate max.	1 × 10 <sup>-3</sup> Pa·cm <sup>3</sup> /s	1 × 10 <sup>-3</sup> Pa·cm <sup>3</sup> /s	1 × 10 <sup>-3</sup> Pa·cm <sup>3</sup> /s
Failure Ratings	L, M		
Conformity Standard	GJB65B-99 (MIL-PRF-39016)	GJB1042A-2002 (MIL-PRF-5757)	GJB1042A-2002 (MIL-PRF-5757)
Layout (Bottom view)			
Cross Reference	891: JRW-210M 792: JRW-210M CII: MA TELEDYNE: 412 Hi-G: I MA	TELEDYNE: 412H	CII: MS TELEDYNE: 432 Hi-G: I MS

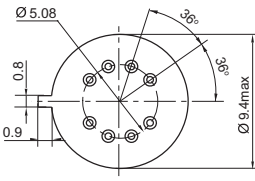
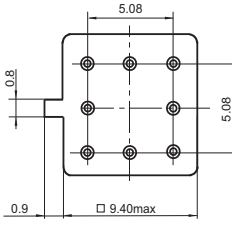
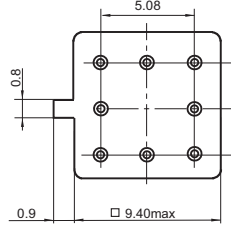

Note: \* Relays are still under developing, specification and dimensions in this catalog are subject to change without notice.

## HERMETICALLY SEALED RELAY SELECTION CHART

Type	HF9113	HF9114	HF9116
Appearance			
Dimensions(L x W x H) mm	Ø 8.51 x 7.11	8.51 x 8.51 x 7.11	8.51 x 8.51 x 7.11
Features	<ul style="list-style-type: none"> <li>Internal diode for coil transient suppression protection</li> <li>Failure rate can be Level M</li> <li>High ambient applicability</li> <li>All metal welded construction</li> <li>Hermetically welded and marked by laser</li> </ul>	<ul style="list-style-type: none"> <li>Grid type output</li> <li>Failure rate can be Level M</li> <li>High ambient applicability</li> <li>All metal welded construction,</li> <li>Hermetically welded and marked by laser</li> </ul>	<ul style="list-style-type: none"> <li>Grid type output</li> <li>With coil transient suppression</li> <li>Failure rate can be Level M</li> <li>High ambient applicability</li> <li>All metal welded construction,</li> <li>Hermetically welded and marked by laser</li> </ul>
<b>Contact Ratings</b>			
Contact Form	2C	2C	2C
Max. Rated Switching Current	1 A	1A	1A
Max. Switching Voltage	28Vd.c. / 115Va.c.(400Hz)	28Vd.c. / 115Va.c.(400Hz)	28Vd.c. / 115Va.c.(400Hz)
Min. Rated Switching Current	50µA	50µA	50µA
Min. Switching Voltage	50mVd.c.	50mVd.c.	50mVd.c.
Rated Load (Resistive load)	1A 28Vd.c.	1A 28Vd.c.	1A 28Vd.c.
<b>Coil Ratings</b>			
Nominal Voltage	5Vd.c. to 27Vd.c.	5Vd.c. to 27Vd.c.	5Vd.c. to 27Vd.c.
Nominal Operating Power	0.5W	0.5W	0.5W
<b>Ambient Adaptability</b>			
Ambient Temperature	-65°C to 125°C	-65°C to 125°C	-65°C to 125°C
Vibration	294m/s <sup>2</sup> 10Hz to 3000Hz	294m/s <sup>2</sup> 10Hz to 3000Hz	294m/s <sup>2</sup> 10Hz to 3000Hz
Shock	735m/s <sup>2</sup>	735m/s <sup>2</sup>	735m/s <sup>2</sup>
Steady-state acceleration	490m/s <sup>2</sup>	490m/s <sup>2</sup>	490m/s <sup>2</sup>
<b>Specifications</b>			
Insulation Resistance min.	10000MΩ	10000MΩ	10000MΩ
Dielectric Strength min.	500Vr.m.s	500Vr.m.s	500Vr.m.s
Operate/Release Time max.	2ms / 4ms	2ms / 1.5ms	2ms / 4ms
Electrical Endurance min.	1 x 10 <sup>5</sup> ops	1 x 10 <sup>5</sup> ops	1 x 10 <sup>5</sup> ops
Leakage Rate max.	1 x 10 <sup>-3</sup> Pa·cm <sup>3</sup> /s	1 x 10 <sup>-3</sup> Pa·cm <sup>3</sup> /s	1 x 10 <sup>-3</sup> Pa·cm <sup>3</sup> /s
Failure Ratings	L、M	L、M	L、M
Conformity Standard	GJB65B-99 (MIL-PRF-39016)	GJB65B-99 (MIL-PRF-39016)	GJB65B-99 (MIL-PRF-39016)
Layout (Bottom view)			
Cross Reference	891: JRW-211M 792: JRW-211M CII: MAD TELEDYNE: 412D Hi-G: I MAD	891: JRW-220MA TELEDYNE: 114 CII: MGA Hi-G: I MGA	891: JRW-221MA 792: JRW-221MC TELEDYNE: 114D CII: MGAD Hi-G: I MGAD

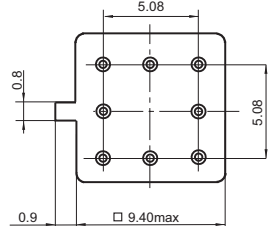
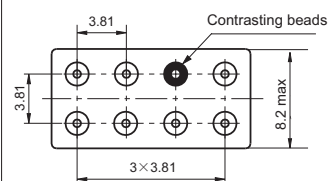
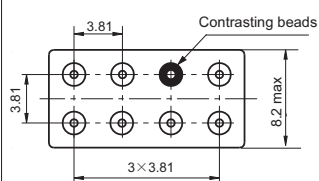

Note: \* Relays are still under developing, specification and dimensions in this catalog are subject to change without notice.

## HERMETICALLY SEALED RELAY SELECTION CHART

Type	HF9117	HF9210	HF9211
Appearance			
Dimensions(L x W x H) mm	8.51 x 8.51 x 7.11	15.5 x 8.2 x 8.2	15.5 x 8.2 x 8.2
Features	<ul style="list-style-type: none"> <li>• Grid type output</li> <li>• With coil transient suppression</li> <li>• Failure rate can be Level M</li> <li>• High ambient applicability</li> <li>• All metal welded construction,</li> <li>• Hermetically welded and marked by laser</li> </ul>	<ul style="list-style-type: none"> <li>• Load can be 2A 28Vd.c</li> <li>• Failure rate level can be level M</li> <li>• High ambient applicability</li> <li>• All metal welded construction</li> <li>• Fusing soldering and marked by laser</li> </ul>	<ul style="list-style-type: none"> <li>• With coil transient suppression</li> <li>• Load can be 2A 28Vd.c</li> <li>• Failure rate level can be level M</li> <li>• High ambient applicability</li> <li>• All metal welded construction</li> <li>• Fusing soldering and marked by laser</li> </ul>
<b>Contact Ratings</b>			
Contact Form	2C	2C	2C
Max.Rated Switching Current	1A	2A	2A
Max.Switching Voltage	28Vd.c. / 115Va.c.(400Hz)	28Vd.c. / 115Va.c.(400Hz)	28Vd.c. / 115Va.c.(400Hz)
Min.Rated Switching Current	50µA	50µA	50µA
Min.Switching Voltage	50mVd.c.	50mVd.c.	50mVd.c.
Rated Load (Resistive load)	1A 28Vd.c.	2A 28Vd.c.	2A 28Vd.c.
<b>Coil Ratings</b>			
Nominal Voltage	5Vd.c. to 27Vd.c.	5Vd.c. to 27Vd.c.	5Vd.c. to 27Vd.c.
Nominal Operating Power	0.64W	0.69W	0.69W
<b>Ambient Adaptability</b>			
Ambient Temperature	-65°C to 125°C	-65°C to 125°C	-65°C to 125°C
Vibration	294m/s <sup>2</sup> 10Hz to 3000Hz	294m/s <sup>2</sup> 10Hz to 3000Hz	294m/s <sup>2</sup> 10Hz to 3000Hz
Shock	735m/s <sup>2</sup>	980m/s <sup>2</sup>	980m/s <sup>2</sup>
Steady-state acceleration	490m/s <sup>2</sup>	980m/s <sup>2</sup>	980m/s <sup>2</sup>
<b>Specifications</b>			
Insulation Resistance min.	10000MΩ	10000MΩ	10000MΩ
Dielectric Strength min.	500Vr.m.s	750Vr.m.s	750Vr.m.s
Operate/Release Time max.	2ms / 4ms	4ms / 4ms	4ms / 6ms
Electrical Endurance min.	1 x 10 <sup>5</sup> OPS	5 x 10 <sup>4</sup> OPS	5 x 10 <sup>4</sup> OPS
Leakage Rate max.	1 × 10 <sup>-3</sup> Pa·cm <sup>3</sup> /s	1 × 10 <sup>-3</sup> Pa·cm <sup>3</sup> /s	1 × 10 <sup>-3</sup> Pa·cm <sup>3</sup> /s
Failure Ratings	L, M	L, M	L, M
Conformity Standard	GJB65B-99 (MIL-PRF-39016)	GJB65B-99 (MIL-PRF-39016)	GJB65B-99 (MIL-PRF-39016)
Layout (Bottom view)			
Cross Reference	891:JRW-222M TELEDYNE: 114DD CII:MGADD Hi-G:I MAGADD	891: JRC-200MA 792: JRC-200M 3412: JZC-064M CII: 3SBC	891: JRC-201MA

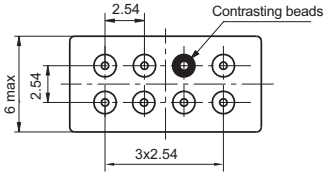
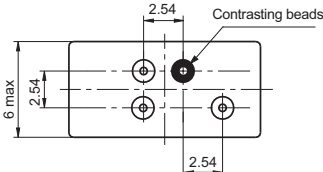
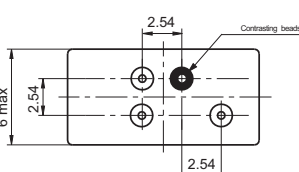

Note: \* Relays are still under developing,specification and dimensions in this catalog are subject to change without notice.

## HERMETICALLY SEALED RELAY SELECTION CHART

Type	HF9215	HF9216	HF9217
Appearance			
Dimensions(L x W x H) mm	13.0 x 6.0 x 12.0	13.0 x 6.0 x 12.0	13.0 x 6.0 x 12.0
Features	<ul style="list-style-type: none"> <li>• Load can be 1A 28Vd.c</li> <li>• Failure rate level can be level M</li> <li>• High ambient applicability</li> <li>• All metal welded construction</li> <li>• Fusing soldering and marked by laser</li> </ul>	<ul style="list-style-type: none"> <li>• Load can be 2A 28Vd.c</li> <li>• High ambient applicability</li> <li>• All metal welded construction</li> <li>• Fusing soldering and marked by laser</li> </ul>	<ul style="list-style-type: none"> <li>• 5A contacts switching capability</li> <li>• High ambient applicability</li> <li>• All metal welded construction</li> <li>• Hermetically welded and marked by laser</li> </ul>
<b>Contact Ratings</b>			
Contact Form	2C	1A	1A
Max.Rated Switching Current	1A	2A	5A
Max.Switching Voltage	28Vd.c.	28Vd.c.	28Vd.c.
Min.Rated Switching Current	50μA	50μA	50μA
Min.Switching Voltage	50mVd.c.	50mVd.c.	50mVd.c.
Rated Load (Resistive load)	1A 28Vd.c.	2A 28Vd.c.	5A 28Vd.c.
<b>Coil Ratings</b>			
Nominal Voltage	6Vd.c.to27Vd.c.	24Vd.c.	24Vd.c.
Nominal Operating Power	0.48W	0.48W	0.48W
<b>Ambient Adaptability</b>			
Ambient Temperature	-65°C to 125°C	-65°C to 125°C	-65°C to 125°C
Vibration	196m/s <sup>2</sup> 10 Hz to 2000 Hz	196m/s <sup>2</sup> 10 Hz to 2000 Hz	196m/s <sup>2</sup> 10Hz to 2000Hz
Shock	980m/s <sup>2</sup>	735m/s <sup>2</sup>	980m/s <sup>2</sup>
Steady-state acceleration	490m/s <sup>2</sup>	490m/s <sup>2</sup>	490m/s <sup>2</sup>
<b>Specifications</b>			
Insulation Resistance min.	10000MΩ	1000MΩ	1000MΩ
Dielectric Strength min.	500Vr.m.s	500Vr.m.s	500Vr.m.s
Operate/Release Time max.	4ms / 4ms	5ms / 5ms	5ms / 5ms
Electrical Endurance min.	1 x 10 <sup>5</sup> OPS	1 x 10 <sup>5</sup> OPS	3 x 10 <sup>4</sup> OPS
Leakage Rate max.	1 × 10 <sup>-3</sup> Pa·cm <sup>3</sup> /s	1 × 10 <sup>-3</sup> Pa·cm <sup>3</sup> /s	1 × 10 <sup>-3</sup> Pa·cm <sup>3</sup> /s
Failure Ratings			
Conformity Standard	GJB65B-99 (MIL-PRF-39016)	GJB65B-99 (MIL-PRF-39016)	GJB1042A-2002 (MIL-PRF-5757)
Layout (Bottom view)			
Cross Reference	792: JRC-10MA 891: JRC-220M 3412: JRC-10M CII: MFW		

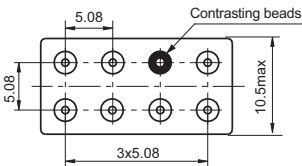
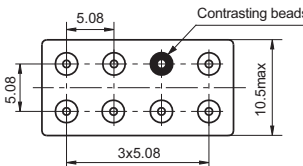
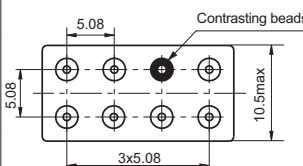

Note: \* Relays are still under developing,specification and dimensions in this catalog are subject to change without notice.

## HERMETICALLY SEALED RELAY SELECTION CHART

Type	HF9310	HF9311	HF9312
Appearance			
Dimensions(L x W x H) mm	20.6 x 10.5 x 10.5	20.6 x 10.5 x 11.5	20.6 x 10.5 x 11.5
Features	<ul style="list-style-type: none"> <li>• Qualified by China military standard</li> <li>• Failure rate level can be level M</li> <li>• High ambient applicability</li> <li>• All metal welded construction</li> <li>• Fusing soldering and marked by laser</li> </ul>	<ul style="list-style-type: none"> <li>• Dielectric strength can be 1200 Vr.m.s</li> <li>• Load can be 5A 28Vd.c.</li> <li>• High ambient applicability</li> <li>• All metal welded construction</li> <li>• Fusing soldering and marked by laser</li> </ul>	<ul style="list-style-type: none"> <li>• Load can be 5A 28Vd.c.</li> <li>• Failure rate level can be level M</li> <li>• High ambient applicability</li> <li>• All metal welded construction</li> <li>• Fusing soldering and marked by laser</li> </ul>
<b>Contact Ratings</b>			
Contact Form	2C	2C	2C
Max.Rated Switching Current	2A	5A	5A
Max.Switching Voltage	28Vd.c. / 115Va.c.(400Hz)	28Vd.c. / 115Va.c.(400Hz)	28Vd.c. / 115Va.c.(400Hz)
Min.Rated Switching Current	50μA	50μA	50μA
Min.Switching Voltage	50mVd.c.	50mVd.c.	50mVd.c.
Rated Load (Resistive load)	2A 28Vd.c.	5A 28Vd.c.	5A 28Vd.c.
<b>Coil Ratings</b>			
Nominal Voltage	5Vd.c. to 27Vd.c.	5Vd.c. to 27Vd.c.	5Vd.c. to 27Vd.c.
Nominal Operating Power	0.9W	1.2W	1.2W
<b>Ambient Adaptability</b>			
Ambient Temperature	-65°C to 125°C	-65°C to 125°C	-65°C to 125°C
Vibration	294m/s <sup>2</sup> 10Hz to 3000Hz	294m/s <sup>2</sup> 10Hz to 3000Hz	294m/s <sup>2</sup> 10Hz to 3000Hz
Shock	980m/s <sup>2</sup>	980m/s <sup>2</sup>	980m/s <sup>2</sup>
Steady-state acceleration	490m/s <sup>2</sup>	490m/s <sup>2</sup>	490m/s <sup>2</sup>
<b>Specifications</b>			
Insulation Resistance min.	10000MΩ	10000MΩ	10000MΩ
Dielectric Strength min.	1000Vr.m.s	1200Vr.m.s	1000Vr.m.s
Operate/Release Time max.	4ms / 4ms	6ms / 4ms	6ms / 4ms
Electrical Endurance min.	1 x 10 <sup>5</sup> ops	1 x 10 <sup>5</sup> ops	1 x 10 <sup>5</sup> ops
Leakage Rate max.	1 × 10 <sup>-3</sup> Pa·cm <sup>3</sup> /s	1 × 10 <sup>-3</sup> Pa·cm <sup>3</sup> /s	1 × 10 <sup>-3</sup> Pa·cm <sup>3</sup> /s
Failure Ratings	L, M		L, M
Conformity Standard	GJB65B-99 (MIL-PRF-39016)	GJB1042A-2002 (MIL-PRF-5757)	GJB65B-99 (MIL-PRF-39016)
Layout (Bottom view)			
Cross Reference	891: JZC-4M 792: KJZC-30M 3412: KJZC-023M CII: HFW NUOVA Hi-G: I 2K	891: JZC-090M 3412: JZC-090M	891: JZC-4MH 3412: KJZC-078M CII: HFW5A/HFC5A NUOVA Hi-G: HA

Note: \* Relays are still under developing,specification and dimensions in this catalog are subject to change without notice.

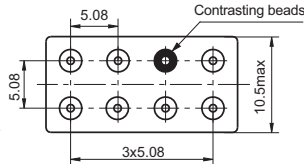
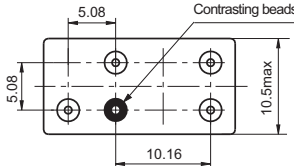
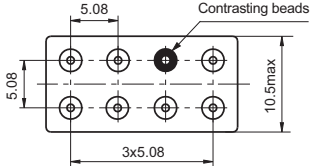

## HERMETICALLY SEALED RELAY SELECTION CHART

Type	HF9313	HF9314	HF9316
Appearance			
Dimensions(L x W x H) mm	20.6 x 10.5 x 10.5	20.6 x 10.5 x 11.5	20.6 x 10.5 x 11.0
Features	<ul style="list-style-type: none"> <li>Ambient temperature can be 180°Cn</li> <li>High ambient applicability</li> <li>All metal welded construction</li> <li>Fusing soldering and marked by laser</li> </ul>	<ul style="list-style-type: none"> <li>Load can be 10A 28Vd.c.</li> <li>1 Form C</li> <li>High ambient applicability</li> <li>All metal welded construction</li> <li>Hermetically welded and marked by laser</li> </ul>	<ul style="list-style-type: none"> <li>Sensitive type</li> <li>Coil power can be 0.5W</li> <li>Failure rate level can be level M</li> <li>High ambient applicability</li> <li>All metal welded construction</li> <li>Fusing soldering and marked by laser</li> </ul>
<b>Contact Ratings</b>			
Contact Form	2C	1C	2C
Max.Rated Switching Current	2A	10A	2A
Max.Switching Voltage	28Vd.c.	28Vd.c.	28Vd.c. / 115Va.c.(400Hz)
Min.Rated Switching Current	50μA		50μA
Min.Switching Voltage	50mVd.c.		50mVd.c.
Rated Load (Resistive load)	2A 28Vd.c.	10A 28Vd.c.	2A 28Vd.c.
<b>Coil Ratings</b>			
Nominal Voltage	5Vd.c. to 27Vd.c.	5Vd.c. to 27 Vd.c.	5Vd.c. to 36Vd.c.
Nominal Operating Power	0.9W	1.2W	0.5W
<b>Ambient Adaptability</b>			
Ambient Temperature	-65°C to 180°C	-65°C to 125°C	-65°C to 125°C
Vibration	294m/s <sup>2</sup> 10Hz to 3000Hz	294m/s <sup>2</sup> 10Hz to 3000Hz	196m/s <sup>2</sup> 10Hz to 2500Hz
Shock	980m/s <sup>2</sup>	980m/s <sup>2</sup>	490m/s <sup>2</sup>
Steady-state acceleration	490m/s <sup>2</sup>	490m/s <sup>2</sup>	490m/s <sup>2</sup>
<b>Specifications</b>			
Insulation Resistance min.	10000MΩ	10000MΩ	10000MΩ
Dielectric Strength min.	1000Vr.m.s	1000Vr.m.s	1000Vr.m.s
Operate/Release Time max.	4ms / 4ms	6ms / 4ms	6ms / 5ms
Electrical Endurance min.	5 x 10 <sup>4</sup> OPS	5 x 10 <sup>4</sup> OPS	1 x 10 <sup>5</sup> OPS
Leakage Rate max.	1 × 10 <sup>-3</sup> Pa·cm <sup>3</sup> /s	1 × 10 <sup>-3</sup> Pa·cm <sup>3</sup> /s	1 × 10 <sup>-3</sup> Pa·cm <sup>3</sup> /s
Failure Ratings			L, M
Conformity Standard	GJB1042A-2002 (MIL-PRF-5757)	GJB65B-1999 (MIL-PRF-39016)	GJB65B-99 (MIL-PRF-39016)
Layout (Bottom view)			
Cross Reference	3412: JRC-023MT	891: JZC-102M 792: JZC-102M 3412: JZC-102M CII: C	3412: JRC-154M CII: HMS

Note: \* Relays are still under developing, specification and dimensions in this catalog are subject to change without notice.



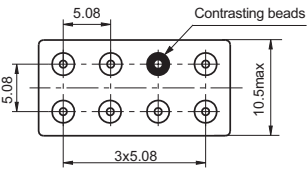
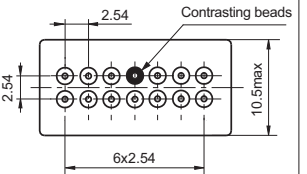
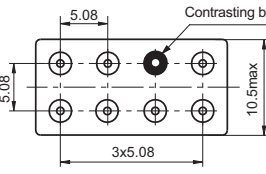

## HERMETICALLY SEALED RELAY SELECTION CHART

Type	HF9317	HF9319	HF9320
Appearance			
Dimensions(L x W x H) mm	20.6 x 10.5 x 11.5	20.6 x 10.5 x 11.5	20.6 x 10.5 x 10.5
Features	<ul style="list-style-type: none"> <li>• Load can be 10A 28Vd.c.</li> <li>• 2 Form C</li> <li>• High ambient applicability</li> <li>• All metal welded construction</li> <li>• Fusing soldering and marked by laser</li> </ul>	<ul style="list-style-type: none"> <li>• 4 form C</li> <li>• Load can be 2A 28Vd.c.</li> <li>• High ambient applicability</li> <li>• All metal welded construction</li> <li>• Fusing soldering and marked by laser</li> </ul>	<ul style="list-style-type: none"> <li>• With coil transient suppression</li> <li>• Failure rate level can be level M</li> <li>• High ambient applicability</li> <li>• All metal welded construction</li> <li>• Fusing soldering and marked by laser</li> </ul>
<b>Contact Ratings</b>			
Contact Form	2C	4C	2C
Max.Rated Switching Current	10A	2A	2A
Max.Switching Voltage	28Vd.c.	28Vd.c./115Va.c. (400Hz)	28Vd.c./115Va.c. (400Hz)
Min.Rated Switching Current		50μA	50μA
Min.Switching Voltage		50mVd.c.	50mVd.c.
Rated Load (Resistive load)	10A 28Vd.c.	2A 28Vd.c.	2A 28Vd.c.
<b>Coil Ratings</b>			
Nominal Voltage	5Vd.c. to 27 Vd.c.	5Vd.c. to 27 Vd.c.	5Vd.c. to 27 Vd.c.
Nominal Operating Power	1.2W	1.2W	0.9W
<b>Ambient Adaptability</b>			
Ambient Temperature	-65°C to 125°C	-65°C to 125°C	-65°C to 125°C
Vibration	294m/s <sup>2</sup> 10Hz to 3000Hz	196m/s <sup>2</sup> 10Hz to 2000Hz	294m/s <sup>2</sup> 10Hz to 3000Hz
Shock	980m/s <sup>2</sup>	735m/s <sup>2</sup>	980m/s <sup>2</sup>
Steady-state acceleration	490m/s <sup>2</sup>	735m/s <sup>2</sup>	490m/s <sup>2</sup>
<b>Specifications</b>			
Insulation Resistance min.	10000MΩ	1000MΩ	10000MΩ
Dielectric Strength min.	1000Vr.m.s	500Vr.m.s	1000Vr.m.s
Operate/Release Time max.	6ms / 4ms	5ms / 5ms	4ms / 7ms
Electrical Endurance min.	3 x 10 <sup>4</sup> OPS	1 x 10 <sup>5</sup> OPS	1 x 10 <sup>5</sup> OPS
Leakage Rate max.	1 x 10 <sup>-3</sup> Pa·cm <sup>3</sup> /s	1 x 10 <sup>-3</sup> Pa·cm <sup>3</sup> /s	1 x 10 <sup>-3</sup> Pa·cm <sup>3</sup> /s
Failure Ratings			
Conformity Standard	GJB65B-99 (MIL-PRF-39016)	GJB65B-99 (MIL-PRF-39016)	GJB65B-99 (MIL-PRF-39016)
Layout (Bottom view)			
Cross Reference		CII: SR 792: JRC-071M 891: JRC-071M 3412: KJRC-071M	

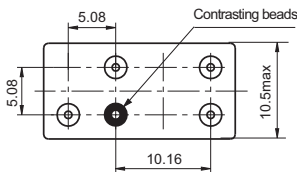
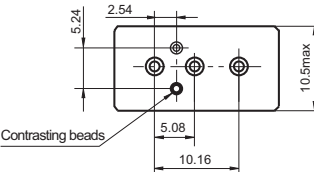
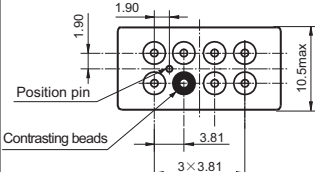

Note: \* Relays are still under developing, specification and dimensions in this catalog are subject to change without notice.

## HERMETICALLY SEALED RELAY SELECTION CHART

Type	HF9323	HF9510	HF9511
Appearance			
Dimensions(L x W x H) mm	20.6 x 10.5 x 11.5	20.6 x 10.5 x 16.3	20.6 x 10.5 x 16.3
Features	<ul style="list-style-type: none"> <li>• Load can be 15A 28Vd.c.</li> <li>• 1 Form C</li> <li>• High ambient applicability</li> <li>• All metal welded construction</li> <li>• Hermetically welded and marked by laser</li> </ul>	<ul style="list-style-type: none"> <li>• Force balanced</li> <li>• With coil transient suppression</li> <li>• 10A contacts switching capability</li> <li>• Failure rate level can be level L</li> <li>• High ambient applicability</li> <li>• All metal welded construction</li> <li>• Hermetically welded and marked by laser</li> </ul>	<ul style="list-style-type: none"> <li>• Force balanced</li> <li>• With coil transient suppression</li> <li>• 5A contacts switching capability</li> <li>• Failure rate level can be level L</li> <li>• High ambient applicability</li> <li>• All metal welded construction</li> <li>• Hermetically welded and marked by laser</li> </ul>
<b>Contact Ratings</b>			
Contact Form	1C	1C	2C
Max.Rated Switching Current	15A	10A	5A
Max.Switching Voltage	28Vd.c.	28Vd.c.	28Vd.c.
Min.Rated Switching Current		50μA	50μA
Min.Switching Voltage		50mVd.c.	50mVd.c.
Rated Load (Resistive load)	15A 28Vd.c.	10A 28Vd.c.	5A 28Vd.c.
<b>Coil Ratings</b>			
Nominal Voltage	5Vd.c. to 27 Vd.c.	6Vd.c. to 28Vd.c.	6Vd.c. to 28Vd.c.
Nominal Operating Power	1.2W	2W	2W
<b>Ambient Adaptability</b>			
Ambient Temperature	-65°C to 125°C	-65°C to 125°C	-65°C to 125°C
Vibration	294m/s <sup>2</sup> 10Hz to 3000Hz	294m/s <sup>2</sup> 10Hz to 3000Hz	294m/s <sup>2</sup> 10Hz to 3000Hz
Shock	980m/s <sup>2</sup>	1960m/s <sup>2</sup>	1960m/s <sup>2</sup>
Steady-state acceleration	490m/s <sup>2</sup>	490m/s <sup>2</sup>	490m/s <sup>2</sup>
<b>Specifications</b>			
Insulation Resistance min.	10000MΩ	100MΩ	100MΩ
Dielectric Strength min.	1000Vr.m.s	1250Vr.m.s	1000Vr.m.s
Operate/Release Time max.	6ms / 4ms	7ms / 7ms	6ms / 6ms
Electrical Endurance min.	1 x 10 <sup>4</sup> OPS	5 x 10 <sup>4</sup> OPS	1 x 10 <sup>5</sup> OPS
Leakage Rate max.	1 × 10 <sup>-3</sup> Pa·cm <sup>3</sup> /s	1 × 10 <sup>-3</sup> Pa·cm <sup>3</sup> /s	1 × 10 <sup>-3</sup> Pa·cm <sup>3</sup> /s
Failure Ratings		L	L
Conformity Standard	GJB65B-1999 (MIL-PRF-39016)	GJB2888-97 (MIL-PRF-83536)	GJB2888-97 (MIL-PRF-83536)
Layout (Bottom view)			
Cross Reference		165:1JT10-1 315: J215 792:JQC-100M LEACH: XC Deutsch: ES110	165:2JT5-3 315: J210 LEACH: X Deutsch: E205

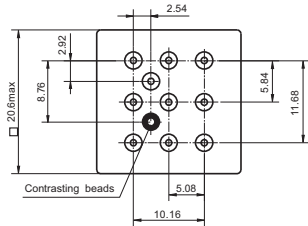
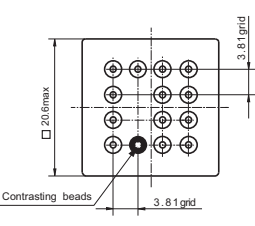
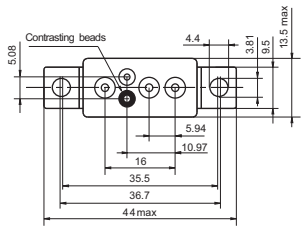

Note: \* Relays are still under developing, specification and dimensions in this catalog are subject to change without notice.

# HERMETICALLY SEALED RELAY SELECTION CHART

Type	HF9512	HF9513	HF9514
Appearance			
Dimensions(L x W x H) mm	20.6 x 20.6 x 16.3	20.6 x 20.6 x 16.3	26.0 x 13.5 x 26.0
Features	<ul style="list-style-type: none"> <li>• Force balanced</li> <li>• With coil transient suppression</li> <li>• 10A contacts switching capability</li> <li>• Failure rate level can be level L</li> <li>• High ambient applicability</li> <li>• All metal welded construction</li> <li>• Hermetically welded and marked by laser</li> </ul>	<ul style="list-style-type: none"> <li>• Force balanced</li> <li>• With coil transient suppression</li> <li>• 5A contacts switching capability</li> <li>• Failure rate level can be level L</li> <li>• High ambient applicability</li> <li>• All metal welded construction</li> <li>• Hermetically welded and marked by laser</li> </ul>	<ul style="list-style-type: none"> <li>• Force balanced</li> <li>• 25A contacts switching capability</li> <li>• Failure rate level can be level L</li> <li>• High ambient applicability</li> <li>• All metal welded construction</li> <li>• Hermetically welded and marked by laser</li> </ul>
<b>Contact Ratings</b>			
Contact Form	3C	4C	1C
Max.Rated Switching Current	10A	5A	25A
Max.Switching Voltage	28Vd.c.	28Vd.c.	28Vd.c.
Min.Rated Switching Current	50μA	50μA	50μA
Min.Switching Voltage	50mVd.c.	50mVd.c.	50mVd.c.
Rated Load (Resistive load)	10A 28Vd.c.	5A 28Vd.c.	25A 28Vd.c.
<b>Coil Ratings</b>			
Nominal Voltage	6Vd.c. to 28Vd.c.	6Vd.c. to 28Vd.c.	28Vd.c.
Nominal Operating Power	2.4W	2.4W	2.5W
<b>Ambient Adaptability</b>			
Ambient Temperature	-65°C to 125°C	-65°C to 125°C	-65°C to 125°C
Vibration	294m/s <sup>2</sup> 10Hz to 3000Hz	294m/s <sup>2</sup> 10Hz to 3000Hz	294m/s <sup>2</sup> 10Hz to 3000Hz
Shock	1960m/s <sup>2</sup>	1960m/s <sup>2</sup>	1960m/s <sup>2</sup>
Steady-state acceleration	490m/s <sup>2</sup>	490m/s <sup>2</sup>	490m/s <sup>2</sup>
<b>Specifications</b>			
Insulation Resistance min.	100MΩ	100MΩ	100MΩ
Dielectric Strength min.	1250Vr.m.s	1000Vr.m.s	1250Vr.m.s
Operate/Release Time max.	7ms / 7ms	7ms / 7ms	10ms / 10ms
Electrical Endurance min.	5 x 10 <sup>4</sup> OPS	1 x 10 <sup>5</sup> OPS	5 x 10 <sup>4</sup> OPS
Leakage Rate max.	1 x 10 <sup>-3</sup> Pa·cm <sup>3</sup> /s	1 x 10 <sup>-3</sup> Pa·cm <sup>3</sup> /s	1 x 10 <sup>-3</sup> Pa·cm <sup>3</sup> /s
Failure Ratings	L	L	L
Conformity Standard	GJB2888-97 (MIL-PRF-83536)	GJB2888-97 (MIL-PRF-83536)	GJB2888-97 (MIL-PRF-83536)
Layout (Bottom view)			
Cross Reference	165:3JT10-1 792: JQC-320M LEACH: YC Deutsch: ES310	165:4JT5-3 792:JZC-40M 315: J220 LEACH: Y Deutsch: ES405	315: J320 792:JQX-20MC 165: 1JT25-1 LEACH: JC Deutsch: E125

Note: \* Relays are still under developing, specification and dimensions in this catalog are subject to change without notice.

## HERMETICALLY SEALED RELAY SELECTION CHART

Type	HF9515	HF9516	HF9517
Appearance			
Dimensions(L x W x H) mm	26.0 x 13.5 x 26.0	26.0 x 26.0 x 26.0	26.0 x 26.0 x 26.0
Features	<ul style="list-style-type: none"> <li>• Force balanced</li> <li>• 10A contacts switching capability</li> <li>• Failure rate level can be level L</li> <li>• High ambient applicability</li> <li>• All metal welded construction</li> <li>• Hermetically welded and marked by laser</li> </ul>	<ul style="list-style-type: none"> <li>• Force balanced I</li> <li>• With coil transient suppression</li> <li>• 25A contacts switching capability</li> <li>• Failure rate level can be level L</li> <li>• High ambient applicability</li> <li>• All metal welded construction</li> <li>• Hermetically welded and marked by laser</li> </ul>	<ul style="list-style-type: none"> <li>• Force balanced</li> <li>• With coil transient suppression</li> <li>• 10A contacts switching capability</li> <li>• Failure rate level can be level L</li> <li>• High ambient applicability</li> <li>• All metal welded construction</li> <li>• Hermetically welded and marked by laser</li> </ul>

### Contact Ratings

Contact Form	2C	3C	4C
Max.Rated Switching Current	10A	25A	10A
Max.Switching Voltage	28Vd.c.	28Vd.c.	28Vd.c.
Min.Rated Switching Current	50μA		50μA
Min.Switching Voltage	50mVd.c.		50mVd.c.
Rated Load (Resistive load)	10A 28Vd.c.	25A 28Vd.c.	10A 28Vd.c.

### Coil Ratings

Nominal Voltage	6Vd.c. to 28Vd.c.	28Vd.c.	6Vd.c. to 28Vd.c.
Nominal Operating Power	2.8W	3W	2.7W

### Ambient Adaptability

Ambient Temperature	-65°C to 125°C	-65°C to 125°C	-65°C to 125°C
Vibration	294m/s <sup>2</sup> 10Hz to 3000Hz	294m/s <sup>2</sup> 10Hz to 3000Hz	294m/s <sup>2</sup> 10Hz to 3000Hz
Shock	1960m/s <sup>2</sup>	1960m/s <sup>2</sup>	1960m/s <sup>2</sup>
Steady-state acceleration	490m/s <sup>2</sup>	490m/s <sup>2</sup>	490m/s <sup>2</sup>

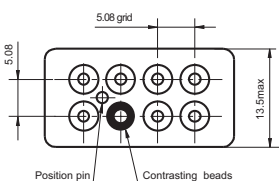
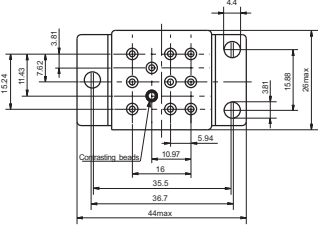
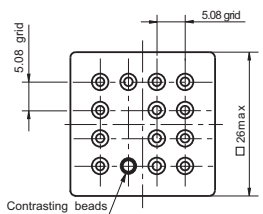

### Specifications

Insulation Resistance min.	100MΩ	100MΩ	100MΩ
Dielectric Strength min.	1250Vr.m.s	1250Vr.m.s	1250Vr.m.s
Operate/Release Time max.	15ms / 15ms	15ms / 15ms	15ms / 15ms
Electrical Endurance min.	1 x 10 <sup>5</sup> OPS	5 x 10 <sup>4</sup> OPS	1 x 10 <sup>5</sup> OPS
Leakage Rate max.	1 × 10 <sup>-3</sup> Pa·cm <sup>3</sup> /s	1 × 10 <sup>-3</sup> Pa·cm <sup>3</sup> /s	1 × 10 <sup>-3</sup> Pa·cm <sup>3</sup> /s
Failure Ratings	L	L	L
Conformity Standard	GJB2888-97 (MIL-PRF-83536)	GJB2888-97 (MIL-PRF-83536)	GJB2888-97 (MIL-PRF-83536)

Layout (Bottom view)			
Cross Reference	165:2JT15-1 315: J300 792:JQX-20MB LEACH: J Deutsch: E210 3412:JQX-100M	315: J500 792: JQC-88MB LEACH: KC Deutsch: ES325	315: J400 3412:JQX-106M 792: JQC-40MB LEACH: K Deutsch: ES410

Note: \* Relays are still under developing, specification and dimensions in this catalog are subject to change without notice.

## HERMETICALLY SEALED RELAY SELECTION CHART

Type	HF9518	HF9519	HF9520
Appearance			
Dimensions(L x W x H) mm	20.6 x 10.5 x 16.3	20.6 x 10.5 x 16.3	20.6 x 20.6 x 16.3
Features	<ul style="list-style-type: none"> <li>• Force balanced</li> <li>• 10A contacts switching capability</li> <li>• Failure rate level can be level L</li> <li>• High ambient applicability</li> <li>• All metal welded construction</li> <li>• Hermetically welded and marked by laser</li> </ul>	<ul style="list-style-type: none"> <li>• Force balanced</li> <li>• 5A contacts switching capability</li> <li>• Failure rate level can be level L</li> <li>• High ambient applicability</li> <li>• All metal welded construction</li> <li>• Hermetically welded and marked by laser</li> </ul>	<ul style="list-style-type: none"> <li>• Force balanced</li> <li>• 10A contacts switching capability</li> <li>• Failure rate level can be level L</li> <li>• High ambient applicability</li> <li>• All metal welded construction</li> <li>• Hermetically welded and marked by laser</li> </ul>

### Contact Ratings

Contact Form	1C	2C	3C
Max.Rated Switching Current	10A	5A	10A
Max.Switching Voltage	28Vd.c.	28Vd.c.	28Vd.c.
Min.Rated Switching Current	50μA	50μA	50μA
Min.Switching Voltage	50mVd.c.	50mVd.c.	50mVd.c.
Rated Load (Resistive load)	10A 28Vd.c.	5A 28Vd.c.	10A 28Vd.c.

### Coil Ratings

Nominal Voltage	6Vd.c. to 28Vd.c.	6Vd.c. to 28Vd.c.	6Vd.c. to 28Vd.c.
Nominal Operating Power	2W	2W	2.4W

### Ambient Adaptability

Ambient Temperature	-65°C to 125°C	-65°C to 125°C	-65°C to 125°C
Vibration	294m/s <sup>2</sup> 10Hz to 3000Hz	294m/s <sup>2</sup> 10Hz to 3000Hz	294m/s <sup>2</sup> 10Hz to 3000Hz
Shock	1960m/s <sup>2</sup>	1960m/s <sup>2</sup>	1960m/s <sup>2</sup>
Steady-state acceleration	490m/s <sup>2</sup>	490m/s <sup>2</sup>	490m/s <sup>2</sup>

### Specifications

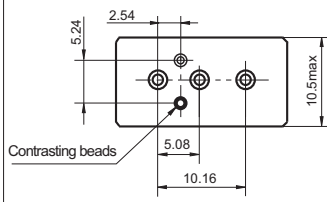
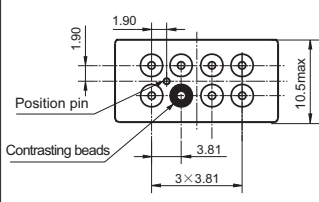
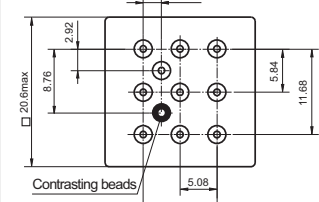

Insulation Resistance min.	100MΩ	100MΩ	100MΩ
Dielectric Strength min.	1250Vr.m.s	1000Vr.m.s	1250Vr.m.s
Operate/Release Time max.	7ms / 7ms	6ms / 6ms	7ms / 7ms
Electrical Endurance min.	5 x 10 <sup>4</sup> OPS	1 x 10 <sup>5</sup> OPS	5 x 10 <sup>4</sup> OPS
Leakage Rate max.	1 x 10 <sup>-3</sup> Pa·cm <sup>3</sup> /s	1 x 10 <sup>-3</sup> Pa·cm <sup>3</sup> /s	1 x 10 <sup>-3</sup> Pa·cm <sup>3</sup> /s
Failure Ratings	L	L	L
Conformity Standard	GJB2888-97 (MIL-PRF-83536)	GJB2888-97 (MIL-PRF-83536)	GJB2888-97 (MIL-PRF-83536)

Layout (Bottom view)			
----------------------	---	--	---

Cross Reference	315: J215 LEACH: XC Deutsch: E110	165:2JT5-3 315: J210 792:JZC-20M LEACH: X Deutsch: ES205	LEACH: YC Deutsch: E310
-----------------	---	--	----------------------------

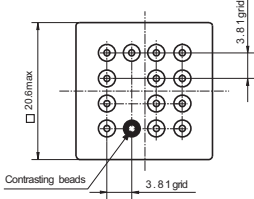
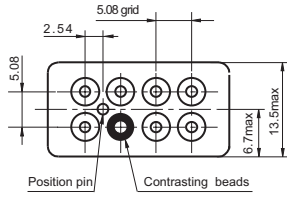
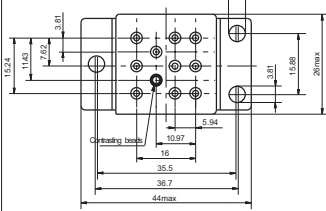

Note: \* Relays are still under developing, specification and dimensions in this catalog are subject to change without notice.

## HERMETICALLY SEALED RELAY SELECTION CHART

Type	HF9521	HF9522	HF9525
Appearance			
Dimensions(L x W x H) mm	20.6 x 20.6 x 16.3	26.0 x 13.5 x 26.0	26.0 x 26.0 x 26.0
Features	<ul style="list-style-type: none"> <li>• Force balanced</li> <li>• 5A contacts switching capability</li> <li>• Failure rate level can be level L</li> <li>• High ambient applicability</li> <li>• All metal welded construction</li> <li>• Hermetically welded and marked by laser</li> </ul>	<ul style="list-style-type: none"> <li>• Force balanced</li> <li>• With coil transient suppression</li> <li>• 10A contacts switching capability</li> <li>• Failure rate level can be level L</li> <li>• High ambient applicability</li> <li>• All metal welded construction</li> <li>• Hermetically welded and marked by laser</li> </ul>	<ul style="list-style-type: none"> <li>• Force balanced</li> <li>• 25A contacts switching capability</li> <li>• Failure rate level can be level L</li> <li>• High ambient applicability</li> <li>• All metal welded construction</li> <li>• Hermetically welded and marked by laser</li> </ul>
<b>Contact Ratings</b>			
Contact Form	4C	2C	3C
Max.Rated Switching Current	5A	10A	25A
Max.Switching Voltage	28Vd.c.	28Vd.c.	28Vd.c.
Min.Rated Switching Current	50μA	50μA	
Min.Switching Voltage	50mVd.c.	50mVd.c.	
Rated Load (Resistive load)	5A 28Vd.c.	10A 28Vd.c.	25A 28Vd.c.
<b>Coil Ratings</b>			
Nominal Voltage	6Vd.c. to 28Vd.c.	6Vd.c. to 28Vd.c.	28Vd.c.
Nominal Operating Power	2.4W	2.8W	3W
<b>Ambient Adaptability</b>			
Ambient Temperature	-65°C to 125°C	-65°C to 125°C	-65°C to 125°C
Vibration	294m/s <sup>2</sup> 10Hz to 3000Hz	294m/s <sup>2</sup> 10Hz to 3000Hz	294m/s <sup>2</sup> 10Hz to 3000Hz
Shock	1960m/s <sup>2</sup>	1960m/s <sup>2</sup>	1960m/s <sup>2</sup>
Steady-state acceleration	490m/s <sup>2</sup>	490m/s <sup>2</sup>	490m/s <sup>2</sup>
<b>Specifications</b>			
Insulation Resistance min.	100MΩ	100MΩ	100MΩ
Dielectric Strength min.	1000Vr.m.s	1250Vr.m.s	1250Vr.m.s
Operate/Release Time max.	7ms / 7ms	10ms / 10ms	15ms / 15ms
Electrical Endurance min.	1 x 10 <sup>5</sup> OPS	1 x 10 <sup>5</sup> OPS	5 x 10 <sup>4</sup> OPS
Leakage Rate max.	1 × 10 <sup>-3</sup> Pa·cm <sup>3</sup> /s	1 × 10 <sup>-3</sup> Pa·cm <sup>3</sup> /s	1 × 10 <sup>-3</sup> Pa·cm <sup>3</sup> /s
Failure Ratings	L	L	L
Conformity Standard	GJB2888-97 (MIL-PRF-83536)	GJB2888-97 (MIL-PRF-83536)	GJB2888-97 (MIL-PRF-83536)
Layout (Bottom view)			
Cross Reference	315: J220 LEACH: Y Deutsch: E405	315: J300 LEACH: J Deutsch: ES210	315: J500 LEACH: KC Deutsch: E325

Note: \* Relays are still under developing, specification and dimensions in this catalog are subject to change without notice.

## HERMETICALLY SEALED RELAY SELECTION CHART

Type	HF9526	HF9527	HF9532
Appearance			
Dimensions(L x W x H) mm	26.0 x 26.0 x 26.0	26.0 x 13.5 x 26.0	26.0 x 13.5 x 26.0
Features	<ul style="list-style-type: none"> <li>• Force balanced</li> <li>• 10A contacts switching capability</li> <li>• Failure rate level can be level L</li> <li>• High ambient applicability</li> <li>• All metal welded construction</li> <li>• Hermetically welded and marked by laser</li> </ul>	<ul style="list-style-type: none"> <li>• Force balanced</li> <li>• 20A contacts switching capability</li> <li>• Failure rate level can be level L</li> <li>• High ambient applicability</li> <li>• All metal welded construction</li> <li>• Hermetically welded and marked by laser</li> </ul>	<ul style="list-style-type: none"> <li>• Force balanced</li> <li>• 15A contacts switching capability</li> <li>• Failure rate level can be level L</li> <li>• High ambient applicability</li> <li>• All metal welded construction</li> <li>• Hermetically welded and marked by laser</li> </ul>

### Contact Ratings

Contact Form	4C	1C	2C
Max.Rated Switching Current	10A	20A	15A
Max.Switching Voltage	28Vd.c.	28Vd.c.	28Vd.c.
Min.Rated Switching Current	50μA	50μA	50μA
Min.Switching Voltage	50mVd.c.	50mVd.c.	50mVd.c.
Rated Load (Resistive load)	10A 28Vd.c.	20A 28Vd.c.	15A 28Vd.c.

### Coil Ratings

Nominal Voltage	6Vd.c. to 28Vd.c.	28Vd.c.	6Vd.c. to 28Vd.c.
Nominal Operating Power	2.7W	3.2W	2.8W

### Ambient Adaptability

Ambient Temperature	-65°C to 125°C	-65°C to 125°C	-65°C to 125°C
Vibration	294m/s <sup>2</sup> 10Hz to 3000Hz	294m/s <sup>2</sup> 10Hz to 3000Hz	294m/s <sup>2</sup> 10Hz to 3000Hz
Shock	1960m/s <sup>2</sup>	1960m/s <sup>2</sup>	1960m/s <sup>2</sup>
Steady-state acceleration	490m/s <sup>2</sup>	490m/s <sup>2</sup>	490m/s <sup>2</sup>

### Specifications

Insulation Resistance min.	100MΩ	100MΩ	100MΩ
Dielectric Strength min.	1250Vr.m.s	1250Vr.m.s	1250Vr.m.s
Operate/Release Time max.	15ms / 15ms	10ms / 10ms	10ms / 10ms
Electrical Endurance min.	1 x 10 <sup>5</sup> OPS	8 x 10 <sup>4</sup> OPS	1 x 10 <sup>5</sup> OPS
Leakage Rate max.	1 × 10 <sup>-3</sup> Pa·cm <sup>3</sup> /s	1 × 10 <sup>-3</sup> Pa·cm <sup>3</sup> /s	1 × 10 <sup>-3</sup> Pa·cm <sup>3</sup> /s
Failure Ratings	L	L	L
Conformity Standard	GJB2888-97 (MIL-PRF-83536)	GJB2888-97 (MIL-PRF-83536)	GJB2888-97 (MIL-PRF-83536)

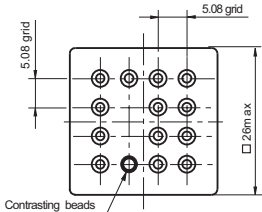
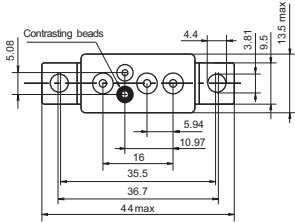
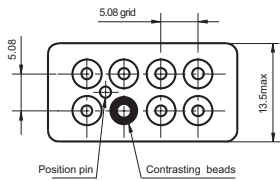

Layout (Bottom view)			
----------------------	---	--	---

Cross Reference	315: J400 LEACH: K Deutsch: E410		
-----------------	--	--	--

Note: \* Relays are still under developing, specification and dimensions in this catalog are subject to change without notice.



## HERMETICALLY SEALED RELAY SELECTION CHART

Type	HF9533	HF9610	HF9611
Appearance			
Dimensions(L x W x H) mm	20.6 x 10.5 x 16.3	20.6 x 10.5 x 16.3	20.6 x 10.5 x 16.3
Features	<ul style="list-style-type: none"> <li>• Force balanced</li> <li>• 15A contacts switching capability</li> <li>• Failure rate level can be level L</li> <li>• High ambient applicability</li> <li>• All metal welded construction</li> <li>• Hermetically welded and marked by laser</li> </ul>	<ul style="list-style-type: none"> <li>• Latching relay</li> <li>• 10A contacts switching capability</li> <li>• Failure rate level can be level L</li> <li>• High ambient applicability</li> <li>• All metal welded construction</li> <li>• Hermetically welded and marked by laser</li> </ul>	<ul style="list-style-type: none"> <li>• Latching relay</li> <li>• 5A contacts switching capability</li> <li>• Failure rate level can be level L</li> <li>• High ambient applicability</li> <li>• All metal welded construction</li> <li>• Hermetically welded and marked by laser</li> </ul>

### Contact Ratings

Contact Form	1C	1C	2C
Max.Rated Switching Current	15A	10A	5A
Max.Switching Voltage	28Vd.c.	28Vd.c.	28Vd.c.
Min.Rated Switching Current	50μA	50μA	50μA
Min.Switching Voltage	50mVd.c.	50mVd.c.	50mVd.c.
Rated Load (Resistive load)	15A 28Vd.c.	10A 28Vd.c.	5A 28Vd.c.

### Coil Ratings

Nominal Voltage	6Vd.c. to 28Vd.c.	6Vd.c. to 28Vd.c.	6Vd.c. to 28Vd.c.
Nominal Operating Power	2W	1.2W	1.2W

### Ambient Adaptability

Ambient Temperature	-65°C to 125°C	-65°C to 125°C	-65°C to 125°C
Vibration	294m/s <sup>2</sup> 10Hz to 3000Hz	294m/s <sup>2</sup> 10Hz to 3000Hz	294m/s <sup>2</sup> 10Hz to 3000Hz
Shock	1960m/s <sup>2</sup>	1960m/s <sup>2</sup>	1960m/s <sup>2</sup>
Steady-state acceleration	490m/s <sup>2</sup>	490m/s <sup>2</sup>	490m/s <sup>2</sup>

### Specifications

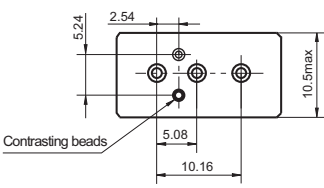
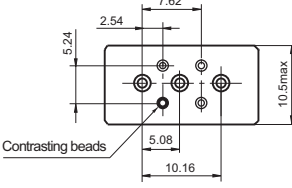
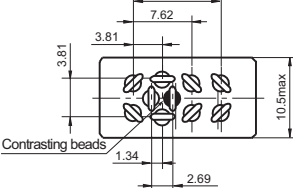

Insulation Resistance min.	100MΩ	100MΩ	100MΩ
Dielectric Strength min.	1250Vr.m.s	1000Vr.m.s	1000Vr.m.s
Operate/Release Time max.	7ms / 7ms	7ms	6ms (Operate time)
Electrical Endurance min.	1 x 10 <sup>4</sup> OPS	5 x 10 <sup>4</sup> OPS	1 x 10 <sup>5</sup> OPS
Leakage Rate max.	1 × 10 <sup>-3</sup> Pa·cm <sup>3</sup> /s	1 × 10 <sup>-3</sup> Pa·cm <sup>3</sup> /s	1 × 10 <sup>-3</sup> Pa·cm <sup>3</sup> /s
Failure Ratings	L	L	L
Conformity Standard	GJB2888-97 (MIL-PRF-83536)	GJB2888-97 (MIL-PRF-83536)	GJB2888-97 (MIL-PRF-83536)

Layout (Bottom view)			
Cross Reference		165:1JB10-1 LEACH: XCL	165: 2JB5-1 LEACH: XL Deutsch: EL205

Note: \* Relays are still under developing, specification and dimensions in this catalog are subject to change without notice.



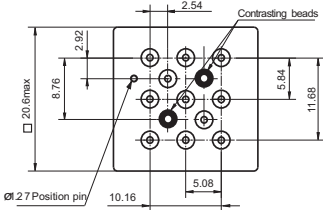
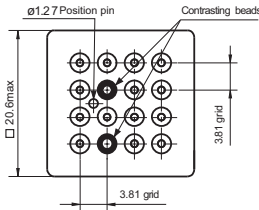
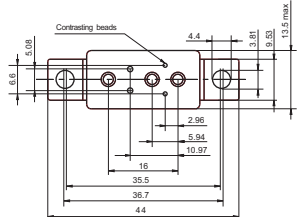

## HERMETICALLY SEALED RELAY SELECTION CHART

Type	HF9612*	HF9613*	HF9614*
Appearance			
Dimensions(L x W x H) mm	20.6 x 20.6 x 16.3	20.6 x 20.6 x 16.3	26.0 x 13.5 x 26.0
Features	<ul style="list-style-type: none"> <li>Force balanced latching relay</li> <li>10A contacts switching capability</li> <li>Failure rate level can be level L</li> <li>High ambient applicability</li> <li>All metal welded construction</li> <li>Hermetically welded and marked by laser</li> </ul>	<ul style="list-style-type: none"> <li>Force balanced latching relay</li> <li>5A contacts switching capability</li> <li>Failure rate level can be level L</li> <li>High ambient applicability</li> <li>All metal welded construction</li> <li>Hermetically welded and marked by laser</li> </ul>	<ul style="list-style-type: none"> <li>Force balanced latching relay</li> <li>25A contacts switching capability</li> <li>Failure rate level can be level L</li> <li>High ambient applicability</li> <li>All metal welded construction</li> <li>Hermetically welded and marked by laser</li> </ul>
<b>Contact Ratings</b>			
Contact Form	3C	4C	1C
Max.Rated Switching Current	10A	5A	25A
Max.Switching Voltage	28Vd.c.	28Vd.c.	28Vd.c.
Min.Rated Switching Current	50µA	50µA	50µA
Min.Switching Voltage	50mVd.c.	50mVd.c.	50mVd.c.
Rated Load (Resistive load)	10A 28Vd.c.	5A 28Vd.c.	25A 28Vd.c.
<b>Coil Ratings</b>			
Nominal Voltage	6Vd.c. to 28Vd.c.	6Vd.c. to 28Vd.c.	28Vd.c.
Nominal Operating Power	1.5W	1.5W	1.3W
<b>Ambient Adaptability</b>			
Ambient Temperature	-65°C to 125°C	-65°C to 125°C	-65°C to 125°C
Vibration	294m/s <sup>2</sup> 10Hz to 3000Hz	294m/s <sup>2</sup> 10Hz to 3000Hz	294m/s <sup>2</sup> 10Hz to 3000Hz
Shock	1960m/s <sup>2</sup>	1960m/s <sup>2</sup>	1960m/s <sup>2</sup>
Steady-state acceleration	490m/s <sup>2</sup>	490m/s <sup>2</sup>	490m/s <sup>2</sup>
<b>Specifications</b>			
Insulation Resistance min.	100MΩ	100MΩ	100MΩ
Dielectric Strength min.	1250Vr.m.s	1000Vr.m.s	1250Vr.m.s
Operate/Release Time max.	7ms (Operate time)	7ms (Operate time)	10ms (Operate time)
Electrical Endurance min.	5 x 10 <sup>4</sup> OPS	1 x 10 <sup>5</sup> OPS	5 x 10 <sup>4</sup> OPS
Leakage Rate max.	1 × 10 <sup>-3</sup> Pa·cm <sup>3</sup> /s	1 × 10 <sup>-3</sup> Pa·cm <sup>3</sup> /s	1 × 10 <sup>-3</sup> Pa·cm <sup>3</sup> /s
Failure Ratings	L	L	L
Conformity Standard	GJB2888-97 (MIL-PRF-83536)	GJB2888-97 (MIL-PRF-83536)	GJB2888-97 (MIL-PRF-83536)
Layout (Bottom view)			
Cross Reference	165: 3JB10-1 LEACH: YCL	165: 4JB5-3 LEACH: YL	792: JMX-280MA LEACH: JCL

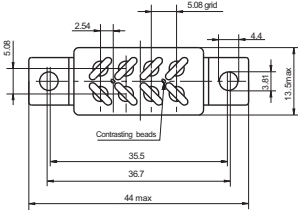
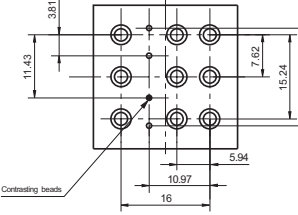
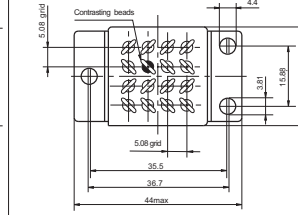

Note: \* Relays are still under developing, specification and dimensions in this catalog are subject to change without notice.

## HERMETICALLY SEALED RELAY SELECTION CHART

Type	HF9615 *	HF9616	HF9617
Appearance			
Dimensions(L x W x H) mm	26.0 x 13.5 x 26.0	26.0 x 26.0 x 26.0	26.0 x 26.0 x 26.0
Features	<ul style="list-style-type: none"> <li>• Force balanced latching relay</li> <li>• 10A contacts switching capability</li> <li>• Failure rate level can be level L</li> <li>• High ambient applicability</li> <li>• All metal welded construction</li> <li>• Hermetically welded and marked by laser</li> </ul>	<ul style="list-style-type: none"> <li>• Force balanced latching relay</li> <li>• 25A contacts switching capability</li> <li>• Failure rate level can be level L</li> <li>• High ambient applicability</li> <li>• All metal welded construction</li> <li>• Hermetically welded and marked by laser</li> </ul>	<ul style="list-style-type: none"> <li>• Force balanced latching relay</li> <li>• 10A contacts switching capability</li> <li>• Failure rate level can be level L</li> <li>• High ambient applicability</li> <li>• All metal welded construction</li> <li>• Hermetically welded and marked by laser</li> </ul>
<b>Contact Ratings</b>			
Contact Form	2C	3C	4C
Max.Rated Switching Current	10A	25A	10A
Max.Switching Voltage	28Vd.c.	28Vd.c.	28Vd.c.
Min.Rated Switching Current	50μA		50μA
Min.Switching Voltage	50mVd.c.		50mVd.c.
Rated Load (Resistive load)	10A 28Vd.c.	25A 28Vd.c.	10A 28Vd.c.
<b>Coil Ratings</b>			
Nominal Voltage	6Vd.c. to 28Vd.c.	28Vd.c.	6Vd.c. to 28Vd.c.
Nominal Operating Power	2W	2W	2W
<b>Ambient Adaptability</b>			
Ambient Temperature	-65°C to 125°C	-65°C to 125°C	-65°C to 125°C
Vibration	294m/s <sup>2</sup> 10Hz to 3000Hz	294m/s <sup>2</sup> 10Hz to 3000Hz	294m/s <sup>2</sup> 10Hz to 3000Hz
Shock	1960m/s <sup>2</sup>	1960m/s <sup>2</sup>	1960m/s <sup>2</sup>
Steady-state acceleration	490m/s <sup>2</sup>	490m/s <sup>2</sup>	490m/s <sup>2</sup>
<b>Specifications</b>			
Insulation Resistance min.	100MΩ	100MΩ	100MΩ
Dielectric Strength min.	1250Vr.m.s	1250Vr.m.s	1250Vr.m.s
Operate/Release Time max.	10ms (Operate time)	15ms (Operate time)	15ms (Operate time)
Electrical Endurance min.	1 x 10 <sup>5</sup> OPS	5 x 10 <sup>4</sup> OPS	1 x 10 <sup>5</sup> OPS
Leakage Rate max.	1 × 10 <sup>-3</sup> Pa·cm <sup>3</sup> /s	1 × 10 <sup>-3</sup> Pa·cm <sup>3</sup> /s	1 × 10 <sup>-3</sup> Pa·cm <sup>3</sup> /s
Failure Ratings	L	L	L
Conformity Standard	GJB2888-97 (MIL-PRF-83536)	GJB2888-97 (MIL-PRF-83536)	GJB2888-97 (MIL-PRF-83536)
Layout (Bottom view)			
Cross Reference	315: J302 792: JMX-280M 3412: JQX-081M LEACH: JL Deutsch: ELS210	315: J502 LEACH: KCL Deutsch: EL325	165:3JB20-1 315: J402 LEACH: KL Deutsch: EL410

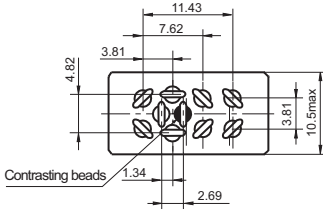
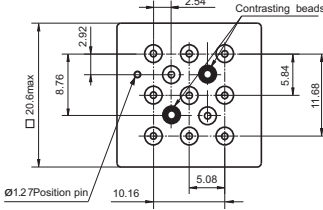
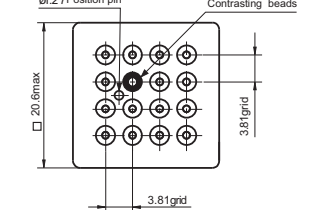

Note: \* Relays are still under developing, specification and dimensions in this catalog are subject to change without notice.

# HERMETICALLY SEALED RELAY SELECTION CHART

Type	HF9618	HF9619*	HF9620*
Appearance			
Dimensions(L x W x H) mm	20.6 x 10.5 x 16.3	20.6 x 20.6 x 16.3	20.6 x 20.6 x 16.3
Features	<ul style="list-style-type: none"> <li>Latching relay</li> <li>With coil transient suppression</li> <li>5A contacts switching capability</li> <li>Failure rate level can be level L</li> <li>High ambient applicability</li> <li>All metal welded construction</li> <li>Hermetically welded and marked by laser</li> </ul>	<ul style="list-style-type: none"> <li>Force balanced latching relay</li> <li>With coil transient suppression</li> <li>10A contacts switching capability</li> <li>Failure rate level can be level L</li> <li>High ambient applicability</li> <li>All metal welded construction</li> <li>Hermetically welded and marked by laser</li> </ul>	<ul style="list-style-type: none"> <li>Force balanced latching relay</li> <li>With coil transient suppression</li> <li>5A contacts switching capability</li> <li>Failure rate level can be level L</li> <li>High ambient applicability</li> <li>All metal welded construction</li> <li>Hermetically welded and marked by laser</li> </ul>
<b>Contact Ratings</b>			
Contact Form	2C	3C	4C
Max.Rated Switching Current	5A	10A	5A
Max.Switching Voltage	28Vd.c.	28Vd.c.	28Vd.c.
Min.Rated Switching Current	50µA	50µA	50µA
Min.Switching Voltage	50mVd.c.	50mVd.c.	50mVd.c.
Rated Load (Resistive load)	5A 28Vd.c.	10A 28Vd.c.	5A 28Vd.c.
<b>Coil Ratings</b>			
Nominal Voltage	6Vd.c. to 28Vd.c.	6Vd.c. to 28Vd.c.	6Vd.c. to 28Vd.c.
Nominal Operating Power	1.2W	1.5W	1.5W
<b>Ambient Adaptability</b>			
Ambient Temperature	-65°C to 125°C	-65°C to 125°C	-65°C to 125°C
Vibration	294m/s <sup>2</sup> 10Hz to 3000Hz	294m/s <sup>2</sup> 10Hz to 3000Hz	294m/s <sup>2</sup> 10Hz to 3000Hz
Shock	1960m/s <sup>2</sup>	1960m/s <sup>2</sup>	1960m/s <sup>2</sup>
Steady-state acceleration	490m/s <sup>2</sup>	490m/s <sup>2</sup>	490m/s <sup>2</sup>
<b>Specifications</b>			
Insulation Resistance min.	100MΩ	100MΩ	100MΩ
Dielectric Strength min.	1000Vr.m.s	1250Vr.m.s	1000Vr.m.s
Operate/Release Time max.	6ms (Operate time)	7ms (Operate time)	7ms (Operate time)
Electrical Endurance min.	1 x 10 <sup>5</sup> OPS	5 x 10 <sup>4</sup> OPS	1 x 10 <sup>5</sup> OPS
Leakage Rate max.	1 x 10 <sup>-3</sup> Pa·cm <sup>3</sup> /s	1 x 10 <sup>-3</sup> Pa·cm <sup>3</sup> /s	1 x 10 <sup>-3</sup> Pa·cm <sup>3</sup> /s
Failure Ratings	L	L	L
Conformity Standard	GJB2888-97 (MIL-PRF-83536)	GJB2888-97 (MIL-PRF-83536)	GJB2888-97 (MIL-PRF-83536)
Layout (Bottom view)			
Cross Reference	LEACH: XL Deutsch: ELS205	LEACH: YCL	LEACH: YL

Note: \* Relays are still under developing, specification and dimensions in this catalog are subject to change without notice.

# HERMETICALLY SEALED RELAY SELECTION CHART

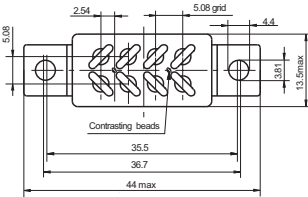
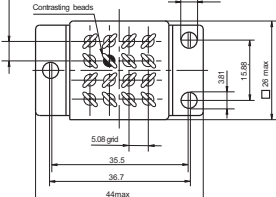
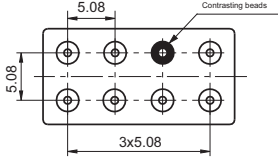

Type	HF9621*	HF9622	HF9710
Appearance			
Dimensions(L x W x H) mm	26.0 x 13.5 x 26.0	26.0 x 26.0 x 26.0	20.6 x 10.5 x 16.3
Features	<ul style="list-style-type: none"> <li>• Force balanced latching relay</li> <li>• With coil transient suppression</li> <li>• 10A contacts switching capability</li> <li>• Failure rate level can be level L</li> <li>• High ambient applicability</li> <li>• All metal welded construction</li> <li>• Hermetically welded and marked by laser</li> </ul>	<ul style="list-style-type: none"> <li>• Force balanced latching relay</li> <li>• With coil transient suppression</li> <li>• 10A contacts switching capability</li> <li>• Failure rate level can be level L</li> <li>• High ambient applicability</li> <li>• All metal welded construction</li> <li>• Hermetically welded and marked by laser</li> </ul>	<ul style="list-style-type: none"> <li>• time delay relay</li> <li>• 5A contacts switching capability</li> <li>• High ambient applicability</li> <li>• All metal welded construction</li> <li>• Hermetically welded and marked by laser</li> </ul>
<b>Contact Ratings</b>			
Contact Form	2C	4C	2Z
Max.Rated Switching Current	10A	10A	5A
Max.Switching Voltage	28Vd.c.	28Vd.c.	28Vd.c. / 115Va.c.(400Hz)
Min.Rated Switching Current	50μA	50μA	50μA
Min.Switching Voltage	50mVd.c.	50mVd.c.	50mVd.c.
Rated Load (Resistive load)	10A 28Vd.c.	10A 28Vd.c.	5A 28Vd.c.
<b>Coil Ratings</b>			
Nominal Voltage	6Vd.c. to 28Vd.c.	6Vd.c. to 28Vd.c.	9 Vd.c. to 27Vd.c.
Nominal Operating Power	2W	2W	1.5W
<b>Ambient Adaptability</b>			
Ambient Temperature	-65°C to 125°C	-65°C to 125°C	-55°C to 85°C
Vibration	294m/s <sup>2</sup> 10Hz to 3000Hz	294m/s <sup>2</sup> 10Hz to 3000Hz	196m/s <sup>2</sup> 10Hz to 2000Hz
Shock	1960m/s <sup>2</sup>	1960m/s <sup>2</sup>	735m/s <sup>2</sup>
Steady-state acceleration	490m/s <sup>2</sup>	490m/s <sup>2</sup>	490m/s <sup>2</sup>
<b>Specifications</b>			
Insulation Resistance min.	100MΩ	100MΩ	10000MΩ
Dielectric Strength min.	1250Vr.m.s	1250Vr.m.s	1000Vr.m.s.
Operate/Release Time max.	10ms (Operate time)	15ms (Operate time)	Delay range:0.2s to 360s
Electrical Endurance min.	1 x 10 <sup>5</sup> OPS	1 x 10 <sup>5</sup> OPS	1 x 10 <sup>5</sup> OPS
Leakage Rate max.	1 x 10 <sup>-3</sup> Pa·cm <sup>3</sup> /s	1 x 10 <sup>-3</sup> Pa·cm <sup>3</sup> /s	1 x 10 <sup>-3</sup> Pa·cm <sup>3</sup> /s
Failure Ratings	L	L	
Conformity Standard	GJB2888-97 (MIL-PRF-83536)	GJB2888-97 (MIL-PRF-83536)	
Layout (Bottom view)			
Cross Reference	315: J302 LEACH: JL Deutsch: ELS210	315: J402 LEACH: KL Deutsch: ELS410	792:JSB-43M 891:JSB-55M

Note: \* Relays are still under developing,specification and dimensions in this catalog are subject to change without notice.

# RELAY SOCKET SELECTION CHART

## 49F/49FA Sockets (Applicable relay types: HF49FD)

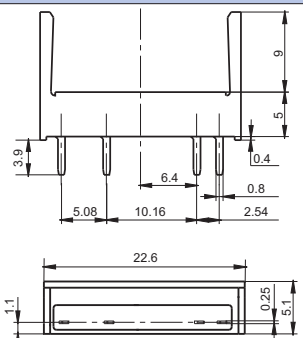
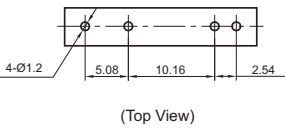
Unit: mm

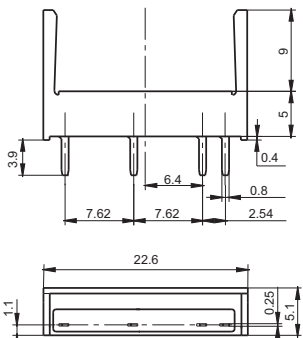
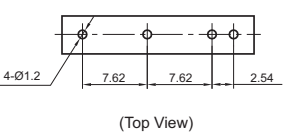
Socket	Outline Dimensions	PCB Layout	Accessory Available
<p>49F</p>  <p>PCB terminal, PCB mounting Applicable for HF49FD 1 type</p>	 <p>(Top View)</p>	 <p>(Top View)</p>	
<p>49FA</p>  <p>PCB terminal, PCB mounting Applicable for HF49FD 2 type</p>	 <p>(Top View)</p>	 <p>(Top View)</p>	

## 41F Sockets (Applicable relay types: HF41F)

Unit: mm

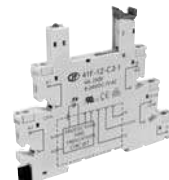
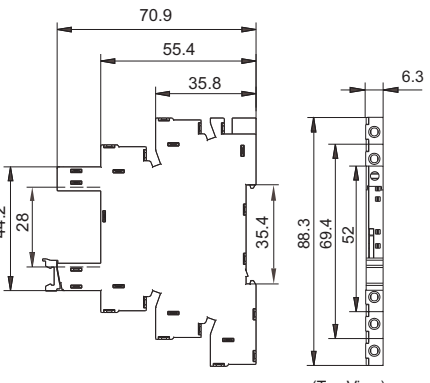
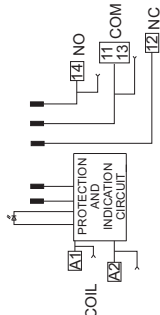
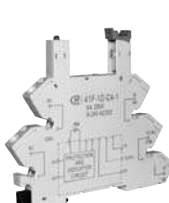
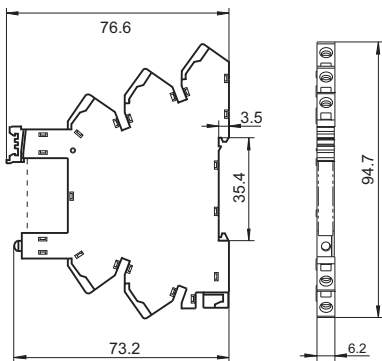
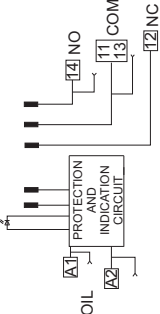
Socket	Outline Dimensions	Wiring Diagram	Accessory Available
<p>41F-1Z-C2-1/2/3/4/5</p>  <p>Screw terminal, DIN rail mounting, With finger protection device Certified by VDE and UL/CUL</p>	 <p>(Top View)</p>		<p>*marker 41F-M 41F-M1</p> <p>*jumper 41F-J1(blue) 41F-J1R(red) 41F-J1B(black)</p> <p>*separator 41F-S</p>
<p>41F-1Z-C4-1/2/3/4/5</p>  <p>Spring-loaded terminal, DIN rail mounting, With finger protection device</p>			<p>*marker 41F-M 41F-M1</p> <p>*jumper 41F-J1(blue) 41F-J1R(red) 41F-J1B(black)</p> <p>*separator 41F-S</p>

# RELAY SOCKET SELECTION CHART



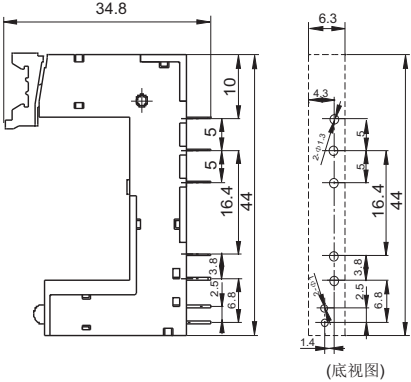
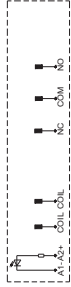



(To be continued)

Socket	Outline Dimensions	Wiring Diagram	Accessory Available
<p>41F-1Z-A2-1/2</p>  <p>PCB terminal, PCB mounting</p>	 <p>(底视图)</p>		<p>*marker 41F-M</p>

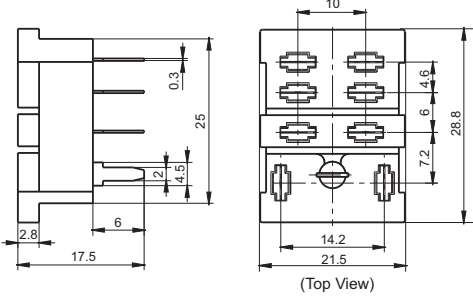
Notes: \* If need accessory, please order with type.

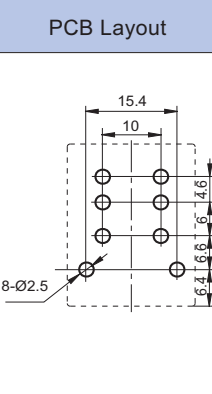
## 13F Sockets (Applicable relay types: HF13F)

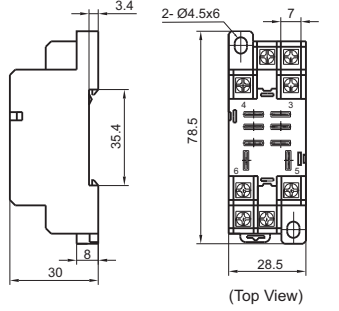
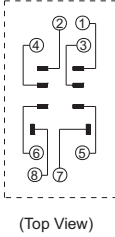
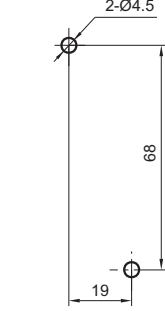

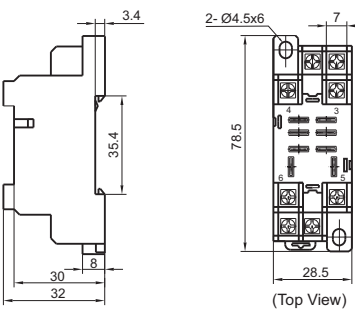
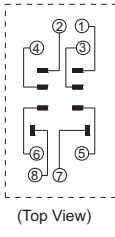
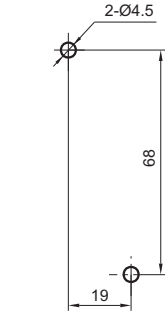



Unit: mm

Socket	Outline Dimensions	Wiring Diagram	PCB Layout	Accessory Available
<p>13F-2Z-A2</p>  <p>PCB terminal, PCB mounting</p>	 <p>(Top View)</p>			<p>metallic retainer 18FF-H1</p>
<p>13F-2Z-C1</p>  <p>Screw terminal, DIN rail or Screw mounting, Without finger protection device</p>	 <p>(Top View)</p>	 <p>(Top View)</p>		<p>metallic retainer 18FF-H2 (be used in sets)</p>
<p>13F-2Z-C2</p>  <p>Screw terminal, DIN rail or Screw mounting, With finger protection device</p>	 <p>(Top View)</p>	 <p>(Top View)</p>		<p>metallic retainer 18FF-H2 (be used in sets)</p>

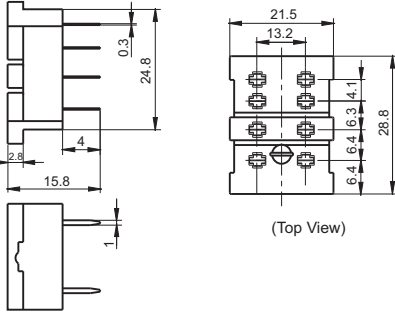
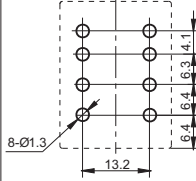
# RELAY SOCKET SELECTION CHART

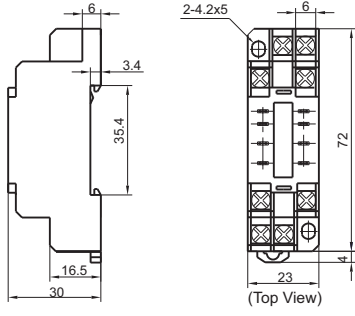
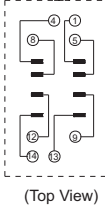
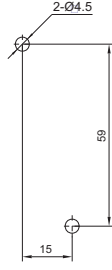

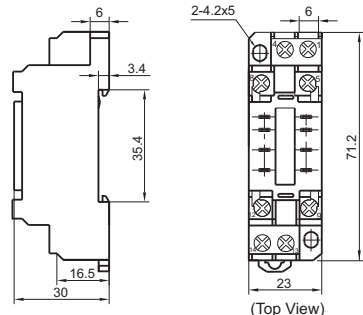
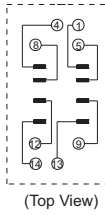
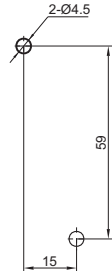

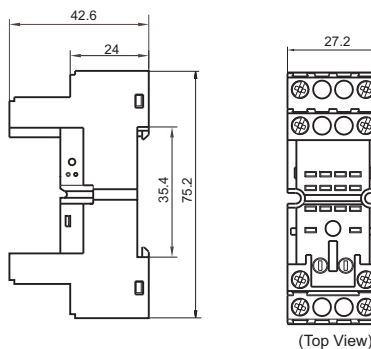
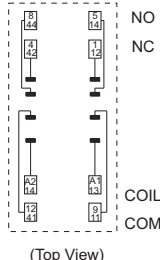
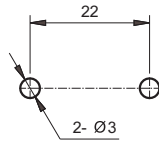

## 18FF Sockets (Applicable relay types: HF18FF/HF18FH)

Unit: mm

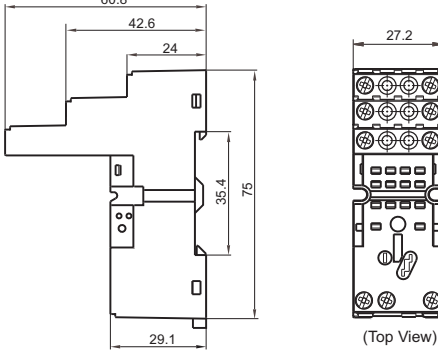
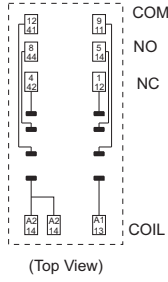
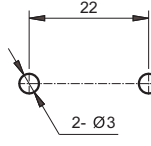
Socket	Outline Dimensions	Wiring Diagram	PCB Layout	Accessory Available
<p>18FF-2Z-A2</p>  <p>PCB Terminal, PCB mounting Applicable for 2 poles</p>	 <p>(Top View)</p>			<p>*metallic retainer 18FF-H1</p>
<p>18FF-2Z-C1</p>  <p>Screw Terminal, DIN rail or Screw mounting, Without finger protection device Applicable for 2 poles</p>	 <p>(Top View)</p>	 <p>(Top View)</p>		<p>*metallic retainer 18FF-H2 (be used in sets)</p>
<p>18FF-2Z-C2</p>  <p>Screw Terminal, DIN rail or Screw mounting, With finger protection device Applicable for 2 poles</p>	 <p>(Top View)</p>	 <p>(Top View)</p>		<p>*metallic retainer 18FF-H2 (be used in sets)</p>
<p>18FF-2Z-C4</p>  <p>Screw Terminal, DIN rail or Screw mounting, With finger protection device Applicable for 2 poles</p>	 <p>(Top View)</p>	 <p>(Top View)</p>		<p>*plastic retainer 18FF-H4  *metallic retainer 18FF-H5  *plug-in module HFAA to HFHU  marker 18FF-M1</p>

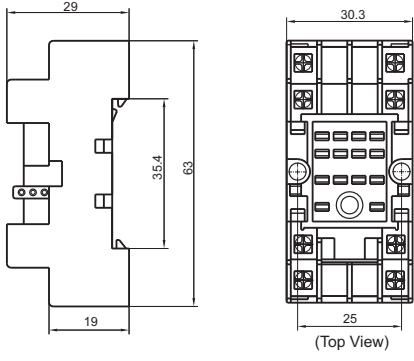
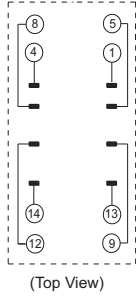
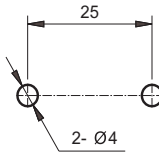
# RELAY SOCKET SELECTION CHART

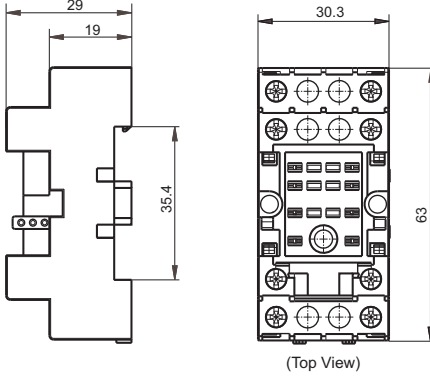
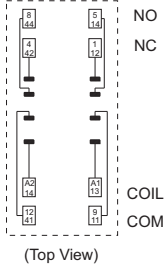
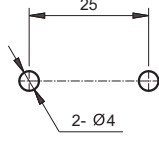

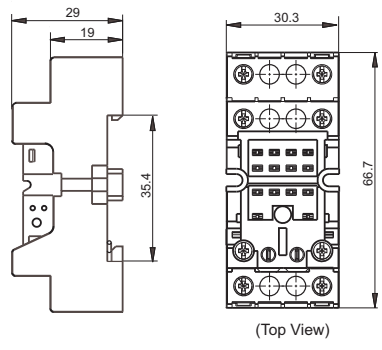
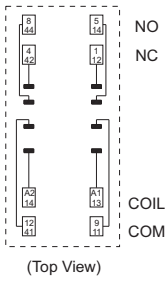
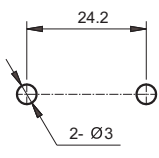



(To be continued)

Socket	Outline Dimensions	Wiring Diagram	PCB Layout	Accessory Available
<p><b>18FF-2Z-C5</b></p>  <p>Screw Terminal, DIN rail or Screw mounting, With finger protection device Applicable for 2 poles</p>	 <p>(Top View)</p>	 <p>(Top View)</p>		<p>*plastic retainer 18FF-H4</p> <p>*metallic retainer 18FF-H5</p> <p>*plug-in module HFAA to HFHU</p> <p>marker 18FF-M1</p>
<p><b>18FF-2Z-C6</b></p>  <p>Screw Terminal, DIN rail or Screw mounting, Applicable for 2 poles</p>	 <p>(Top View)</p>	 <p>(Top View)</p>		<p>*metallic retainer 18FF-H6 (be used in sets)</p> <p>marker 18FF-M2</p>
<p><b>18FF-2Z-C7</b></p>  <p>Screw Terminal, DIN rail or Screw mounting, With finger protection device Applicable for 2 poles</p>	 <p>(Top View)</p>	 <p>(Top View)</p>		<p>*metallic retainer 18FF-H5</p> <p>marker 18FF-M2</p>
<p><b>18FF-2Z-C8</b></p>  <p>Screw Terminal, DIN rail or Screw mounting, With finger protection device Applicable for 2 poles</p>	 <p>(Top View)</p>	 <p>(Top View)</p>		<p>*metallic retainer 18FF-H5</p> <p>*plastic retainer 18FF-H4</p> <p>*plug-in module HFAA to HFHU</p> <p>marker 18FF-M3</p>

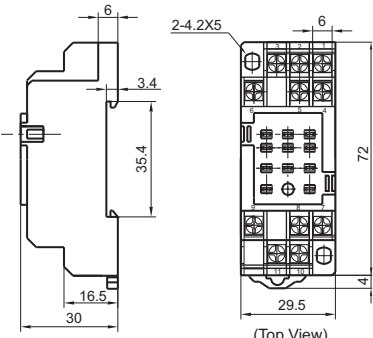
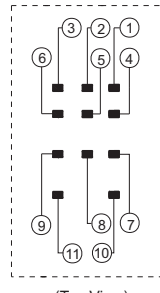
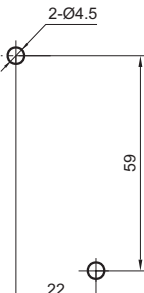

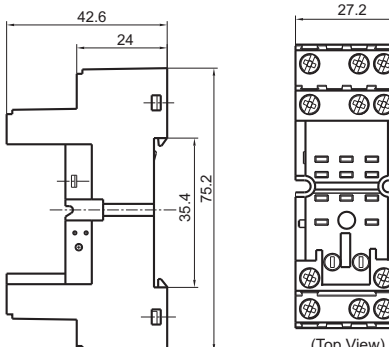
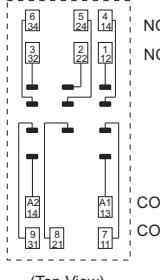
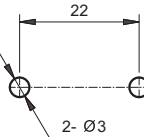

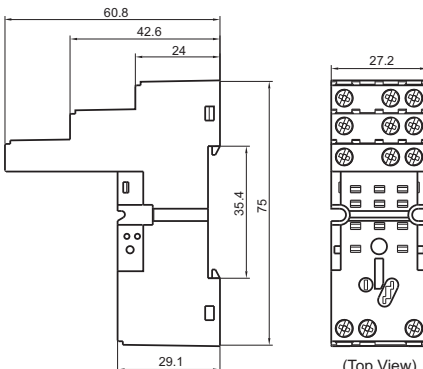
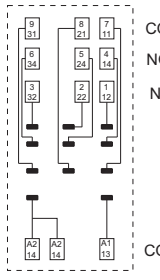
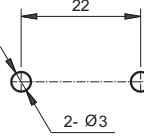

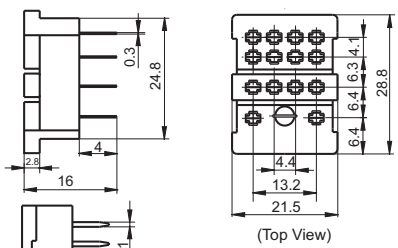
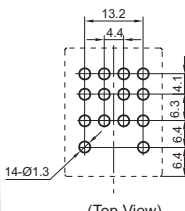

# RELAY SOCKET SELECTION CHART

(To be continued)

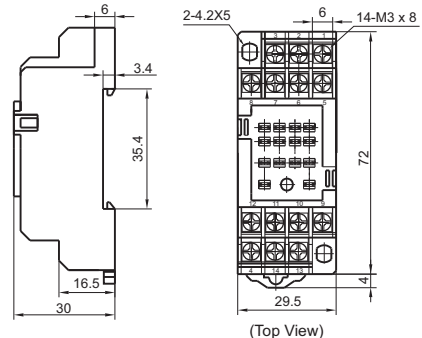
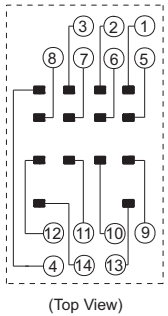
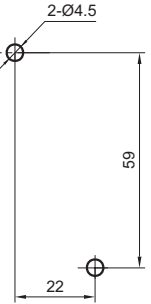

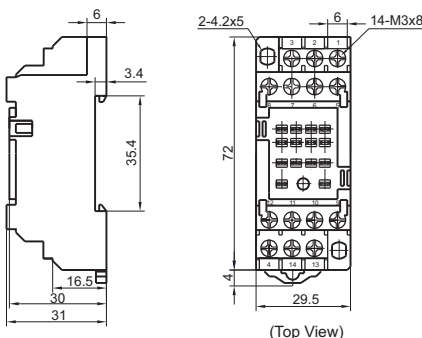
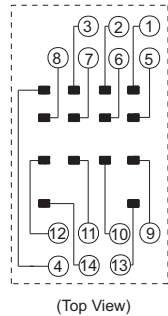
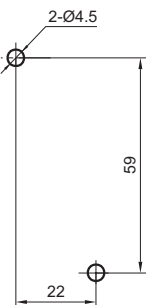
Socket	Outline Dimensions	Wiring Diagram	PCB Layout	Accessory Available
<p>18FF-3Z-C1</p>  <p>Screw Terminal, DIN rail or Screw mounting, Without finger protection device Applicable for 3 poles</p>	 <p>(Top View)</p>	 <p>(Top View)</p>		<p>*metallic retainer 18FF-H2 (be used in sets)</p>
<p>18FF-3Z-C4</p>  <p>Screw Terminal, DIN rail or Screw mounting, With finger protection device Applicable for 3 poles</p>	 <p>(Top View)</p>	 <p>(Top View)</p>		<p>*plastic retainer 18FF-H4</p> <p>*metallic retainer 18FF-H5</p> <p>*plug-in module HFAA to HFHU</p> <p>marker 18FF-M1</p>
<p>18FF-3Z-C5</p>  <p>Screw Terminal, DIN rail or Screw mounting, With finger protection device Applicable for 3 poles</p>	 <p>(Top View)</p>	 <p>(Top View)</p>		<p>*plastic retainer 18FF-H4</p> <p>*metallic retainer 18FF-H5</p> <p>*plug-in module HFAA to HFHU</p> <p>marker 18FF-M1</p>
<p>18FF-4Z-A2</p>  <p>PCB Terminal, PCB mounting Applicable for 4 poles</p>	 <p>(Top View)</p>		 <p>(Top View)</p>	<p>*metallic retainer 18FF-H1</p>

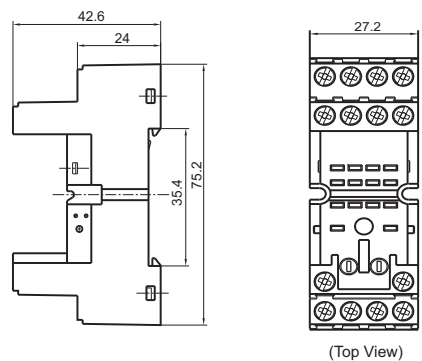
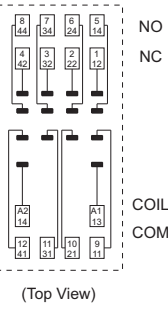
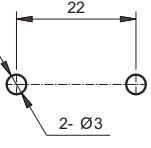
# RELAY SOCKET SELECTION CHART

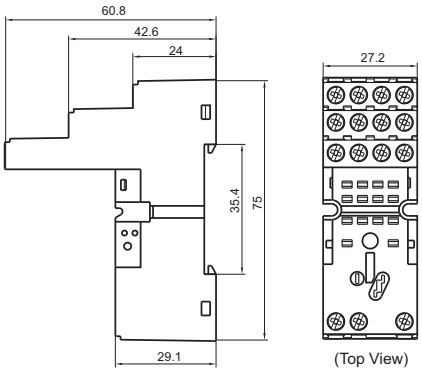
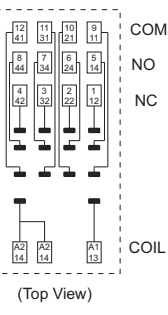
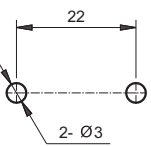
(To be continued)

Socket	Outline Dimensions	Wiring Diagram	PCB Layout	Accessory Available
<p><b>18FF-4Z-C1</b></p>  <p>Screw Terminal, DIN rail or Screw mounting, Without finger protection device Applicable for 4 poles</p>	 <p>(Top View)</p>	 <p>(Top View)</p>		<p>*metallic retainer 18FF-H2 (be used in sets)</p>
<p><b>18FF-4Z-C2</b></p>  <p>Screw Terminal, DIN rail or Screw mounting, With finger protection device Applicable for 4 poles</p>	 <p>(Top View)</p>	 <p>(Top View)</p>		<p>*metallic retainer 18FF-H2 (be used in sets)</p>
<p><b>18FF-4Z-C4</b></p>  <p>Screw Terminal, DIN rail or Screw mounting, With finger protection device Applicable for 4 poles</p>	 <p>(Top View)</p>	 <p>(Top View)</p>		<p>*plastic retainer 18FF-H4 *metallic retainer 18FF-H5 *plug-in module HFAA to HFHU marker 18FF-M1</p>
<p><b>18FF-4Z-C5</b></p>  <p>Screw Terminal, DIN rail or Screw mounting, With finger protection device Applicable for 4 poles</p>	 <p>(Top View)</p>	 <p>(Top View)</p>		<p>*plastic retainer 18FF-H4 *metallic retainer 18FF-H5 *plug-in module HFAA to HFHU marker 18FF-M1</p>

# RELAY SOCKET SELECTION CHART

					(To be continued)
Socket	Outline Dimensions	Wiring Diagram	PCB Layout	Accessory Available	
<p><b>18FF-4Z-C6</b></p>  <p>Screw Terminal, DIN rail or Screw mounting, Applicable for 4 poles</p>	<p>(Top View)</p>	<p>(Top View)</p>		<p>*metallic retainer 18FF-H6 (be used in sets)</p> <p>marker 18FF-M2</p>	
<p><b>18FF-4Z-C7</b></p>  <p>Screw Terminal, DIN rail or Screw mounting, With finger protection device Applicable for 4 poles</p>	<p>(Top View)</p>	<p>(Top View)</p>		<p>*metallic retainer 18FF-H5</p> <p>marker 18FF-M2</p>	
<p><b>18FF-4Z-C8</b></p>  <p>Screw Terminal, DIN rail or Screw mounting, With finger protection device Applicable for 4 poles</p>	<p>(Top View)</p>	<p>(Top View)</p>		<p>*metallic retainer 18FF-H5</p> <p>*plastic retainer 18FF-H4</p> <p>*plug-in module HFAA to HFHU</p> <p>marker 18FF-M3</p>	





Notes: \* If need accessory, please order with type.

## 10FF Sockets (Applicable relay types: HF10FF/HF10FH)

					Unit: mm
Socket	Outline Dimensions	Wiring Diagram	PCB Layout	Accessory Available	
<p><b>10FF-2Z-C1</b></p>  <p>Screw terminal DIN rail or Screw mounting Without finger protection device Applicable for 2 poles</p>	<p>(Top View)</p>	<p>(Top View)</p>			





# RELAY SOCKET SELECTION CHART

(To be continued)

Socket	Outline Dimensions	Wiring Diagram	PCB Layout	Accessory Available
<p>10FF-2Z-C2</p>  <p>Screw terminal DIN rail or Screw mounting With finger protection device Applicable for 2 poles</p>	<p>(Top View)</p>	<p>(Top View)</p>		
<p>10FF-2Z-C3</p>  <p>Screw terminal DIN rail or Screw mounting With finger protection device Applicable for 2 poles</p>	<p>(Top View)</p>	<p>(Top View)</p>		<p>*metallic retainer 10FF-H1</p>
<p>10FF-2Z-C4</p>  <p>Screw terminal DIN rail or Screw mounting With finger protection device Applicable for 2 poles</p>	<p>(Top View)</p>	<p>(Top View)</p>		<p>*metallic retainer 10FF-H1</p> <p>*plug-in module HFFAA to HFFHU</p>
<p>10FF-3Z-C1</p>  <p>Screw terminal DIN rail or Screw mounting Without finger protection device Applicable for 3 poles</p>	<p>(Top View)</p>	<p>(Top View)</p>		

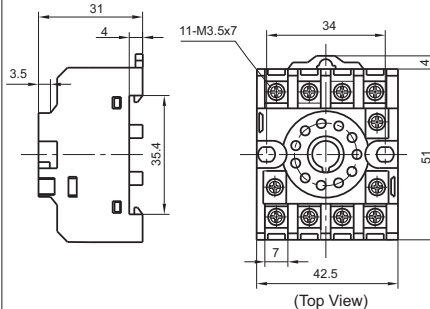
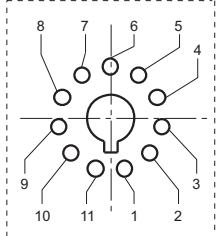
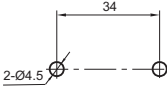
# RELAY SOCKET SELECTION CHART

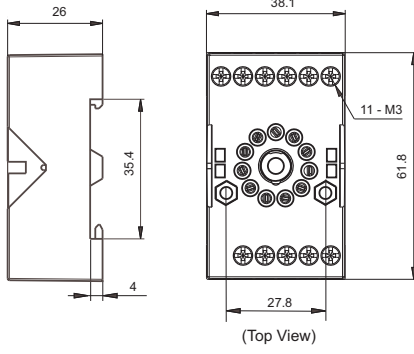
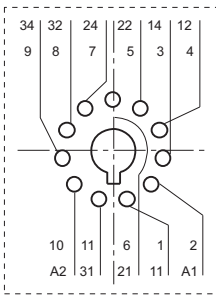
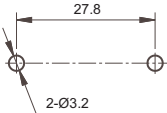
(To be continued)

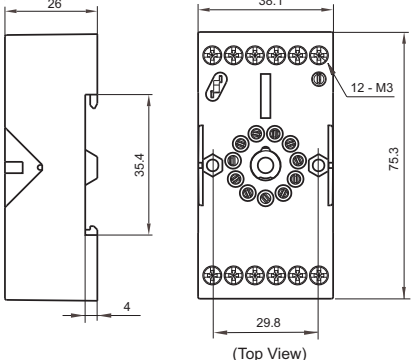
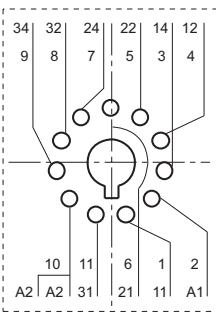
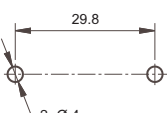
Socket	Outline Dimensions	Wiring Diagram	PCB Layout	Accessory Available
<p><b>10FF-3Z-C2</b></p>  <p>Screw terminal DIN rail or Screw mounting With finger protection device Applicable for 3 poles</p>	 <p>(Top View)</p>	 <p>(Top View)</p>		
<p><b>10FF-3Z-C3</b></p>  <p>Screw terminal DIN rail or Screw mounting With finger protection device Applicable for 3 poles</p>	 <p>(Top View)</p>	 <p>(Top View)</p>		<p>*metallic retainer 10FF-H1</p>
<p><b>10FF-3Z-C4</b></p>  <p>Screw terminal DIN rail or Screw mounting With finger protection device Applicable for 3 poles</p>	 <p>(Top View)</p>	 <p>(Top View)</p>		<p>*metallic retainer 10FF-H1</p> <p>*plug-in module HFFAA to HFFHU</p>

Notes: \* If need accessory, please order with type.

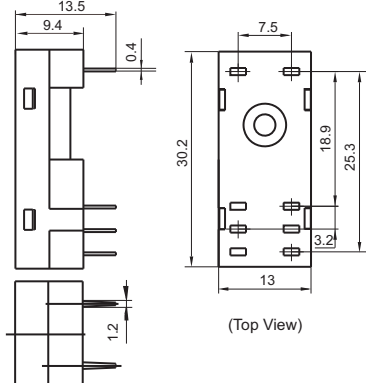
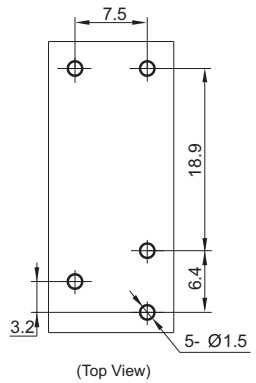

## 118F Sockets (Applicable relay types: HF118F)

Unit: mm

Socket	Outline Dimensions	Wiring Diagram	Accessory Available
<p><b>118F-1Z-A1-1</b></p>  <p>PCB terminal, PCB or Screw mounting Applicable for HF118F 1 type</p>	 <p>(Top View)</p>	 <p>(Top View)</p>	<p>* metallic retainer 118F-H1</p>

# RELAY SOCKET SELECTION CHART

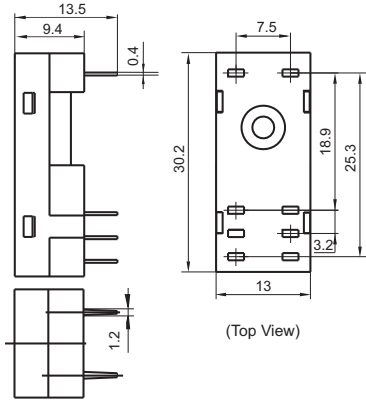
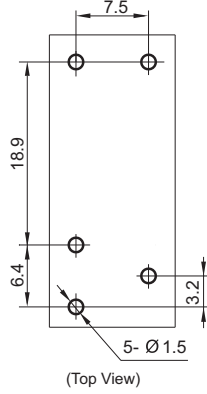
(To be continued)

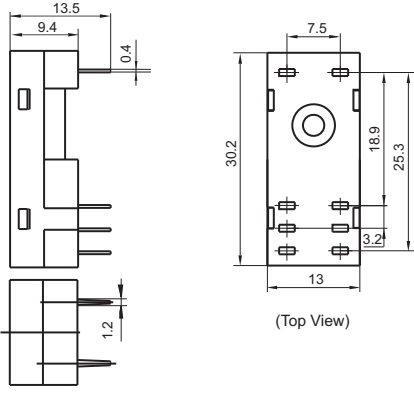
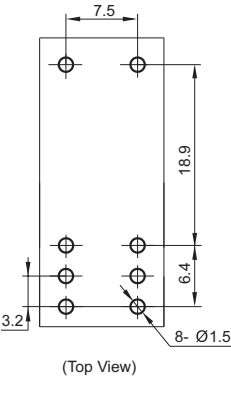
Socket	Outline Dimensions	Wiring Diagram	Accessory Available
<p>118F-1Z-A1-2</p>  <p>PCB terminal, PCB or Screw mounting Applicable for HF118F 2 type</p>	 <p>(Top View)</p>	 <p>(Top View)</p>	<p>* metallic retainer 118F-H1</p>
<p>118F-2Z-A1</p>  <p>PCB terminal, PCB or Screw mounting Applicable for HF118F 3 and 4 type</p>	 <p>(Top View)</p>	 <p>(Top View)</p>	<p>* metallic retainer 118F-H1</p>

Notes: \* If need accessory, please order with type.





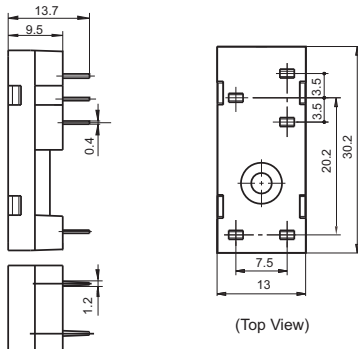
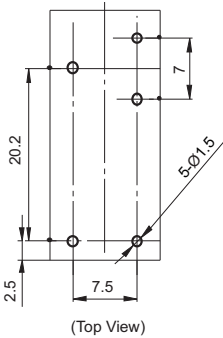

## 14FF Sockets (Applicable relay types: HF115F/115F-A/115FP, HF14FF/14FW/140FF/141FF)

Unit: mm

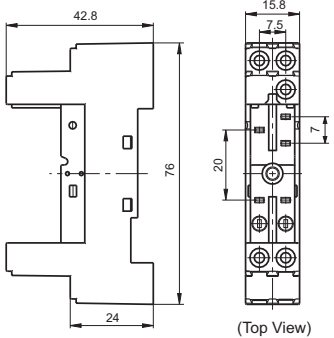
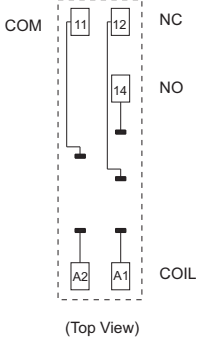
Socket	Outline Dimensions	Wiring Diagram / PCB Layout	Accessory Available
<p>14FF-1Z-A1</p>  <p>PCB terminal, PCB or Screw mounting Applicable for HF14FF/141FF, HF115F/115F-A 1 type</p>	 <p>(Top View)</p>	 <p>(Top View)</p>	<p>*metallic retainer 14FF-H1 14FF-H2</p>

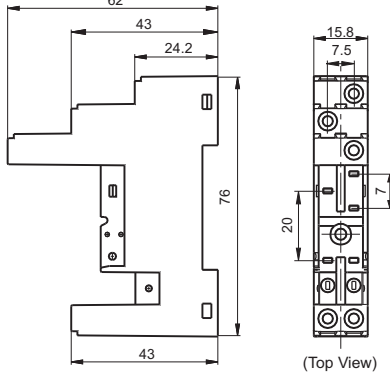
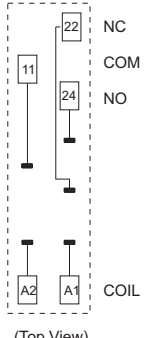

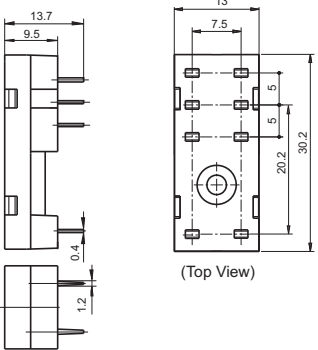
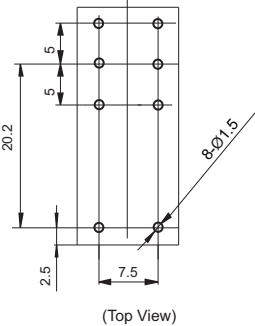
# RELAY SOCKET SELECTION CHART

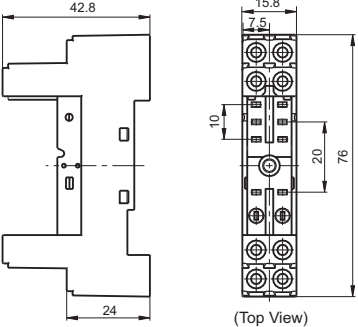
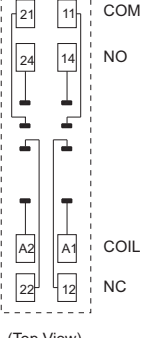
(To be continued)

Socket	Outline Dimensions	Wiring Diagram / PCB Layout	Accessory Available
<p>14FF-1Z-C2</p>  <p>Screw terminal, PCB or Screw mounting With finger protection device Applicable for HF14FF/141FF, HF115F/115F-A 1 type</p>	 <p>(Top View)</p>	 <p>(Top View)</p>	<p>*plastic retainer 14FF-H4 14FF-H5 14FF-H6</p> <p>*jumper 14FF-J1</p> <p>*plug-in module HFAA to HFHU</p> <p>marker 14FF-M1</p>
<p>14FF-1Z-C3</p>  <p>Screw Terminal, DIN rail or Screw mounting, With finger protection device Applicable for HF14FF/141FF, HF115F/115F-A 1 type</p>	 <p>(Top View)</p>	 <p>(Top View)</p>	<p>*plastic retainer 14FF-H4 14FF-H5 14FF-H6</p> <p>*jumper 14FF-J1</p> <p>*plug-in module HFAA to HFHU</p> <p>marker 14FF-M1</p>
<p>14FF-2Z-A1</p>  <p>PCB terminal, PCB or Screw mounting Applicable for HF14FW/140FF, HF115F/115F-A/115FP 3 type &amp; 4 type</p>	 <p>(Top View)</p>	 <p>(Top View)</p>	<p>*metallic retainer 14FF-H1 14FF-H3</p>
<p>14FF-2Z-C2</p>  <p>Screw Terminal, DIN rail or Screw mounting, With finger protection device Applicable for HF14FW/140FF, HF115F/115F-A/115FP 3 type &amp; 4 type When applying to 3 type, 2NC, 2NO and 2COM should be paralled seperately.</p>	 <p>(Top View)</p>	 <p>(Top View)</p>	<p>*plastic retainer 14FF-H4 14FF-H6</p> <p>*jumper 14FF-J1</p> <p>*plug-in module HFAA to HFHU</p> <p>marker 14FF-M1</p>

# RELAY SOCKET SELECTION CHART

(To be continued)

Socket	Outline Dimensions	Wiring Diagram / PCB Layout	Accessory Available
<p><b>14FF-2Z-C3</b></p>  <p>Screw Terminal, DIN rail or Screw mounting, With finger protection device Applicable for HF14FW/140FF, HF115F/115F-A/115FP 3 type &amp; 4 type When applying to 3 type, 2NC, 2NO and 2COM should be paralled seperately.</p>	<p>(Top View)</p>	<p>(Top View)</p>	<p>*plastic retainer 14FF-H4 14FF-H6</p> <p>*jumper 14FF-J1</p> <p>*plug-in module HFAA to HFHU</p> <p>marker 14FF-M1</p>
<p><b>140FF-2Z-C3</b></p>  <p>Screw terminal DIN rail or Screw mounting With finger protection device Applicable for HF14FW/140FF</p>	<p>(Top View)</p>	<p>(Top View)</p>	<p>*plastic retainer 140F-H1</p> <p>*jumper 140FF-J1</p> <p>marker 140FF-M1</p>

Notes: \* If need accesscry,please order with type.

## Disclaimer

This datasheet is for the customers' reference. All the specifications are subject to change without notice.

We could not evaluate all the performance and all the parameters for every possible application. Thus the user should be in a right position to choose the suitable product for their own application. If there is any query, please contact Hongfa for the technical service. However, it is the user's responsibility to determine which product should be used only.

© Xiamen Hongfa Electroacoustic Co., Ltd. All rights of Hongfa are reserved.



## CROSS REFERENCE GUIDE

HONGFA	OMRON	PANASONIC	TE	FUJITSU	SONGCHUAN
HFKA (Single)	G8N-1				103
HFKA (Twin)	G8NW				
HFKC (Single)		CP	V23086-C1		102
HFKC (Twin)			V23086-C2		
HFKD			V23084-C		
HFKF		ATTE/ACJ	Nano		
HFKM			V23072		861
HFKT		CN-H/ ACTC	V23201	FBR-59	905
HFKT-L		RTCIL	V23201-L	FBR-51L	
HFKP	G8PE		V23076/ V23133	FRL274	822E/822
HF3FF-M	G8SN	JSM	T72N		833HM
HFKW	G8QN	JJM		FBR51/52	895
HFKW-SH		JJMD			895
HFV4	G8JN	CB	V23134-A/B / V23234-A/B / V23136-A/B / VF4A		896/896H
HFV4N			V23134-C/ V23234-C		
HFV4-SH			V23134-M		
HFV6	G8HN	CM	V23074-A		871
HFV6V			V23145-B		
HFV6-G	G8HE		V23074-H		
HFV7	G8JR	CB	V23134-J/ V23136-J		897
HFV7A					
HFV9	G8V		VJ28		301
HFV9-G	G8V-RH		VJ28		301
HFV11	G8VL/G8VA		VH28		303
HFV12			V23130/BDS-A		
HFV28	G8W		VF28		898
HFV15	G8JN	CB	V23134-A/B / V23234-A/B / V23136-A/B / VF4A		896/896H
HFV16	G8JR	CB	V23134-J/ V23136-J		897

Notes: This table is just for reference. If you have any questions, please contact our local agent or send e-mail to marketing@hongfa.com.



HONGFA RELAY

ISO9001, ISO/TS16949, ISO14001, OHSAS18001, IECQ QC 080000 CERTIFIED

2015 Rev. 1.00

**RELAYS CLASS TO CLASS CROSS REFERENCE GUIDE**

HONGFA	CII	TELEDYNE	NUOVA Hi-G	792	891	3412
HF9110	MA	412	I MA	JRW-210M	JRW-210M	
HF9111		412H				
HF9112	MS	432	I MS			
HF9113	MAD	412D	I MAD	JRW-211M	JRW-211M	
HF9114	MGA	114	I MGA		JRW-220MA	
HF9310	HFW		I 2K	KJZC-30M	JZC-4M	KJRC-023M
HF9311					JZC-090M	JZC-090M
HF9312	HFW5A/HFC5A		HA		JZC-4MH	KJZC-078M
HF9313						JRC-023MT
HF9314	C			JZC-102M	JZC-102M	JZC-102M
HF9316	HMS					JRC-154M
HF9317						
HF9210	3SBC			JRC-200M	JRC-200MA	JZC-064M

(Continuous)

## RELAYS CLASS TO CLASS CROSS REFERENCE GUIDE

(接上表)

HONGFA	LEACH	DEUTSCH	315	792	165	3412
HF9510	XC	ES110	J215	JZC-100M	1JT10-1	
HF9511	X	ES205	J210	JZC-20M	2JT5-3	
HF9512	YC	ES310		JQC-320M	3JT10-1	
HF9513	Y	ES405	J220	JZC-40M	4JT5-3	
HF9514	JC	E125	J320	JQX-20MC	1JT25-1	
HF9515	J	E210	J300	JQC-20MB	2JT15-1	JQX-100M
HF9516	KC	ES325	J500	JQC-88MB		
HF9517	K	ES410	J400	JQC-40MB		JQX-106M
HF9610	XCL				1JB10-1	
HF9611	XL	E205			2JB5-1	
HF9612	YCL				3JB10-1	
HF9613	YL				4JB5-3	
HF9614	JCL			JMX-280MA		
HF9615	JL	ELS210	J302	JMX-280M		JQX-081M
HF9616	KCL	ELS325	J502			
HF9617	KL	EL410	J402		3JB20-1	

This table is just for reference. If you have any questions, please contact our local agent or send e-mail to [marketing@hongfa.com](mailto:marketing@hongfa.com)

## RELAYS CLASS TO CLASS CROSS REFERENCE GUIDE

HONGFA	CII	TELEDYNE	NUOVA Hi-G	792	891	3412
HF9110	MA	412	I MA	JRW-210M	JRW-210M	
HF9111		412H				
HF9112	MS	432	I MS			
HF9113	MAD	412D	I MAD	JRW-211M	JRW-211M	
HF9114	MGA	114	I MGA		JRW-220MA	
HF9310	HFW		I 2K	KJZC-30M	JZC-4M	KJRC-023M
HF9311					JZC-090M	JZC-090M
HF9312	HFW5A/HFC5A		HA		JZC-4MH	KJZC-078M
HF9313						JRC-023MT
HF9314	C			JZC-102M	JZC-102M	JZC-102M
HF9316	HMS					JRC-154M
HF9317						
HF9210	3SBC			JRC-200M	JRC-200MA	JZC-064M

(Continuous)



HONGFA RELAY  
GJB9001A, ISO9001, ISO/TS16949, ISO14001, OHSAS18001, IECQ QC 080000 CERTIFIED

## RELAYS CLASS TO CLASS CROSS REFERENCE GUIDE

(接上表)

HONGFA	LEACH	DEUTSCH	315	792	165	3412
HF9510	XC	ES110	J215	JZC-100M	1JT10-1	
HF9511	X	ES205	J210	JZC-20M	2JT5-3	
HF9512	YC	ES310		JQC-320M	3JT10-1	
HF9513	Y	ES405	J220	JZC-40M	4JT5-3	
HF9514	JC	E125	J320	JQX-20MC	1JT25-1	
HF9515	J	E210	J300	JQC-20MB	2JT15-1	JQX-100M
HF9516	KC	ES325	J500	JQC-88MB		
HF9517	K	ES410	J400	JQC-40MB		JQX-106M
HF9610	XCL				1JB10-1	
HF9611	XL	E205			2JB5-1	
HF9612	YCL				3JB10-1	
HF9613	YL				4JB5-3	
HF9614	JCL			JMX-280MA		
HF9615	JL	ELS210	J302	JMX-280M		JQX-081M
HF9616	KCL	ELS325	J502			
HF9617	KL	EL410	J402		3JB20-1	

This table is just for reference. If you have any questions, please contact our local agent or send e-mail to [marketing@hongfa.com](mailto:marketing@hongfa.com)



HONGFA RELAY  
GJB9001A, ISO9001, ISO/TS16949, ISO14001, OHSAS18001, IECQ QC 080000 CERTIFIED

## CROSS REFERENCE GUIDE

### Power Relay

HONGFA	OMRON	PANASONIC	TE			NEC
			OEG	P&B	SCHRACK	
HF3FA	G5LA	JS			T7S	
HF3FD	G5LB	JS			T7S	
HF3FF	G5LC/G5LE	JS	PCE/ORWH	T72	T7N	
HF7FD	G5LE-VD	JSM	PCE	T7N	T7N-WG	KB
HF7FF	G5LC/G5LE	JSM	PCE	T7N	T7N	
HF8			OU DH	T73	41891/UB	
HF12FF						
HF14FF	G2R	JR1/JR1A	OMI	RKA/RKS	409/cardE/RPII1	CH
HF14FW	G2R	JR1AF	OMI-H/OZ	RKA/RKS		
HF21FF	G5L		SRUDH/SRUUH	T7C	LN/41896	
HF25F	G5G	LE				
HF32FV			OJ/OJE	T77		CS
HF32F			OJ/OJE	T77		CS
HF32F-G			OJ/OJE	T77		
HF32FA/HF32FA-T			OJ/OJE	T77		
HF32FA-G	G5SB/G5Q	JQ/PQ	OJ/OJE	T77	RE/REL	
HF33F	G5PA-1	LK	PCH	T77		
HF36F/HF36FD			SDT			
HF37F		PE/PF			V23092(SNR)	CK
HF41F	G5PA-2	LA				CW
HF42F	G5NB/G5T	LD	OSA/PCI	T74		
HF46F/HF46F-G	G6DS	PA			PCN	CU
HF49FD	G5J	JR1AF-TMP				
HF62F			OMIF		T92	
HF92F	G4A	LF		T92		
HF102F	G8P	JTN/JTV	PCFN		T9A	
HF105F-1	G7G/G8P	JT	ORU	T9A/T90		CT
HF105F-2	G7G/G8P	JT	ORU	491/T9A		
HF105F-4			ORU	T9A		

This table is just for reference. if you have any questions, please contact our local agent or send e-mail to [marketing@hongfa.com](mailto:marketing@hongfa.com).



HONGFA RELAY  
ISO9001, ISO/TS16949, ISO14001, OHSAS18001, IECQ QC 080000 CERTIFIED

2015 Rev. 1.01

# CROSS REFERENCE GUIDE

(To be continued)

## Power Relay

HONGFA	FUJITSU	FEME	FINDER	SONGCHUAN
HF3FA				899
HF3FD				899
HF3FF		VTA/H	36.11	833H
HF7FD	FBR160			812BH
HF7FF	CS			812
HF8	LZ	EM-EMH		843
HF12FF				834
HF14FF	VS	MZPA-001	40.31	845-1P
HF14FW	FBR610	MZPA-001	40.61	793P
HF21FF				801H
HF25F				
HF32FV	JV			835/835NL
HF32F	JV			835/835NL
HF32F-G	JV			835/835NL
HF32FA/32FA-T	JV			835/835NL
HF32FA-G	JV	JF		835/835NL
HF33F	JY	MXH		892
HF36F/HF36FD	FTR-H2/F2			
HF37F	VF		34.51	
HF41F	FTR-LY			882
HF42F	FTR-F4			401
HF46F/HF46F-G	FTR-F3			202/202H
HF49FD	RB/NY			
HF62F	VR	CS/CF30		302
HF92F				
HF102F				
HF105F-1				832
HF105F-2				832
HF105F-4				832

This table is just for reference.if you have any questions,please contact our local agent or send e-mail to marketing@hongfa.com.



HONGFA RELAY

ISO9001, ISO/TS16949, ISO14001, OHSAS18001, IECQ QC 080000 CERTIFIED

## CROSS REFERENCE GUIDE

### Power Relay

HONGFA	OMRON	PANASONIC	TE			NEC
			OEG	P&B	SCHRACK	
HF105F-5	G7G/G8P	JTN	ORU	T90/T9A		
HF115F	G2RL	JW1/JW2/DJ		RT	RT/42900/RT1/RT2	TH
HF115-A	G5RL-AC				RT1/RT2/RX1/RX2	
HF115F-H				RT	RT1 sensitive	
HF115F-I				RT	42903/42903A/	
HF115F-L		DJ			RT1 bistable	
HF115F-Q					RF/41063 125°C	
HF115F-T/TH				RT	RTH105 16A	
HF115FP					XT	
HF115FK	G2RL	JWI/JWZ/DJ			RZ	
HF115FK-T				RT	RTH105 16A	
HF158F	G2RL				RT/RZ	
HF116F-1	G7L	HE				
HF116F-2	G7L	HE				
HF116F-3	G7L	HE				
HF118F	G6RN				RYII	
HF140FF	G2R/G2RG	JR2/JR2A	OMI	RKA/RKS	409/RPII2/SR2M	TP
HF141FF	G2R	JW	OMI			TP
HF152F/HF152FD	G5LE-VD	JSM				
HF160F	G4F	JM	PCF		PCJ	CU
HF161F	G4A	LF	PCFN			
HF161F-W		LF-G	PCFNSOLAR			
HF162F	G5PF	LK-F				
HF163F-L		DW				
HF165F			T9S SOLAR			
HF2100	G7G	JT		491/T9A		
HF2110/HF2120	G7G	JT	491/T90		T9A	CT
HF2150/HF2151	G7G	JTN/JTV	T9A/T90			CT
HF2160		JT	T9A/T90			CT
HF7520	G5CA	JV/JVN		PCD		CQ
HFE7	G6C	DK				

This table is just for reference.if you have any questions,please contact our local agent or send e-mail to marketing@hongfa.com.



HONGFA RELAY

ISO9001, ISO/TS16949, ISO14001, OHSAS18001, IECQ QC 080000 CERTIFIED



## CROSS REFERENCE GUIDE

(To be continued)

### Power Relay

HONGFA	FUJITSU	FEME	FINDER	SONGCHUAN
HF105F-5				832
HF115F	FTR-K1	M25	41series	881/888
HF115-A				881
HF115F-H	FTR-K1			881/845N
HF115F-I	FTR-H1			881/888
HF115F-L	FTR-K1L			
HF115F-Q				881WP
HF115F-T/TH	FTR-K1			881
HF115FP				
HF115FK	FTR-K1			
HF115FK-T	FTR-K1			881
HF158F				
HF116F-1				841
HF116F-2				841
HF116F-3				841
HF118F	FTR-F1	M15E		
HF140FF	FTR-F1/VSB	MZPA-002	40.52	845-2P
HF141FF	FTR-F1/VSB		40.31	845-H
HF152F				875
HF160F	VH/FTR-K3			821
HF161F				
HF161F-W				
HF162F				
HF163F-L				
HF165F				
HF2100				
HF2110/HF2120		CGQ		832A
HF2150/HF2151		CGQ		832
HF2160				852
HF7520				201
HFE7				

This table is just for reference. if you have any questions, please contact our local agent or send e-mail to [marketing@hongfa.com](mailto:marketing@hongfa.com).



HONGFA RELAY

ISO9001, ISO/TS16949, ISO14001, OHSAS18001, IECQ QC 080000 CERTIFIED

## CROSS REFERENCE GUIDE

### Signal Relay

HONGFA	OMRON	PANASONIC	TE				NEC
			TYCO	AXICOM	OEG	P&B	
HFD23	G5V-1	HY	V23111		TSC		TY
HFD27	G5V-2	DS2Y		D2N (V23105)	OVR/ORZ	T82/T85/190	MR62
HFD2	G6A	DS2Y	V23042	MT2			MR82
HFD3	G6S	TX		P2 (V23079)			EC2/ED2
HFD3-V				FT			
HFD31	G6H	TQ		FP2			EA2
HFD4	G6K	AGQ		IM			
HFD41	G2E			V23101	OUA/OUAZ	T81	
HFD41A	G2E			V23101	OUA/OUAZ	T81	

(To be continued)

HONGFA	FUJITSU	FEME	FINDER	SONGCHUAN
HFD23	SY	EZ-EZH		
HFD27	FBR244/ FTR-C2/RV	ZFH-002	30.22	876
HFD2	RA	TF/TFL2		502
HFD3	BA/NA			902
HFD3-V	FTR-C1			
HFD31	A			
HFD4				
HFD41	FBR211SC/MZ			842
HFD41A	FBR211SE/MZ	ESH-001		842A

This table is just for reference.if you have any questions,please contact our local agent or send e-mail to marketing@hongfa.com.



HONGFA RELAY

ISO9001, ISO/TS16949, ISO14001, OHSAS18001, IECQ QC 080000 CERTIFIED

## PACKING LIST

Type	Packing Method	Carton Size L x W x H cm	QTY/CTN PCS	Approx. N.W. kg	Approx. G.W. kg	Stacking Layers Limit n
HFKA (Single)	50pcs/tube	45 x 21 x 19	3000	12	14	6
HFKA/...C (Single, Tape packing)	240pcs/reel	43 x 43 x 26	1200	4.8	8	5
HFKA (Twin)	23pcs/tube	45 x 21 x 19	1380	11	13	6
HFKA/...C (Twin, Tape packing)	170pcs/reel	43 x 43 x 26	850	6.8	9	5
HFKC (Single)	50pcs/tube	42 x 19 x 18	2000	8	10	7
HFKD (Twin)	25pcs/tube	50 x 20 x 16	1000	10	12	7
HFKF (Single)	50pcs/tube	44 x 25 x 15	3000	9.5	13	6
HFKF (Twin)	25pcs/tube	44 x 25 x 15	1500	9.2	12.7	6
HFKM (Open)	100pcs/tray	35 x 29 x 24	1000	8	9.5	6
HFKM (Plastic sealed)	20pcs/tube	37 x 28 x 18	1200	14.5	16.5	5
HFKT	30pcs/tube	56 x 21 x 16	1200	13.5	15.5	6
HFKT-L	30pcs/tube	56 x 21 x 16	1200	11.5	13.5	6
HFKP (Open)	50pcs/tray	35 x 29 x 22	300	5	6.5	6
HFKP (Plastic sealed)	50pcs/tray	35 x 29 x 23	300	6	8	6
HFKW/HFKW-SH	150pcs/tube	37 x 30 x 19	1500	9	11	7
HFKW/...C (Tape packing)	200pcs/reel	43 x 43 x 26	1000	6	11	5
HFV4(1, 2 type)	40pcs/tray	35 x 29 x 20	200	7	8.5	7
HFV4(4, 6 type)	40pcs/tray	35 x 29 x 20	200	11	12.5	7
HFV4/HFV4-SH (3 type)	16pcs/tray	35 x 29 x 24	80	4.5	6	6
HFV4/HFV4-SH (5 type)	16pcs/tray	35 x 29 x 24	80	4.5	6	6
HFV4-SH (1, 4 type)	40pcs/tray	35 x 29 x 20	200	7	8.5	7
HFV4N (1 type)	40pcs/tray	35 x 29 x 20	200	7	8.5	7
HFV4N (4, 6 type)	40pcs/tray	35 x 29 x 20	200	11	12.5	7
HFV6/HFV6-G(Tray)	50pcs/tray	35 x 29 x 24	500	11	12.5	6
HFV6/HFV6-G(Box)	250pcs/box	44 x 26 x 12	500	11	12	7
HFV6V	250pcs/box	44 x 26 x 12	500	10.2	11.2	7
HFV7/HFV7A(1 type)	40pcs/tray	35 x 29 x 23	240	8.5	9.9	6
HFV7(4 type)	27pcs/tray	35 x 29 x 23	162	5.7	7.1	6
HFV7A(4 type)	40pcs/tray	35 x 29 x 20	200	7	8.4	7
HFV7/HFV7A(6 type)	35pcs/tray	35 x 29 x 24	175	6.2	7.6	6



HONGFA RELAY

ISO9001, ISO/TS16949, ISO14001, OHSAS18001, IECQ QC 080000 CERTIFIED

2015 Rev. 1.10

## PACKING LIST

Type	Packing Method	Carton Size L x W x H cm	QTY/CTN PCS	Approx. N.W. kg	Approx. G.W. kg	Stacking Layers Limit n
HFV9	50pcs/tray	35 x 29 x 24	500	11	12.5	6
HFV9-G	50pcs/tray	35 x 29 x 24	500	11	12.5	6
HFV11	80pcs/tray	35 x 29 x 27	800	16	18	5
HFV12	8pcs/tray	35 x 29 x 24	40	8.5	10	6
HFV15(1 type)	40pcs/tray	35 x 29 x 20	200	7	8.4	7
HFV16(1 type)	40pcs/tray	35 x 29 x 23	240	8.5	9.9	6
HFV28(Standard type)	40pcs/tray	35 x 29 x 23	240	8.4	9.9	6
HFV28(5 type)	16pcs/tray	35 x 29 x 24	80	4.5	6	6
HF3501	30pcs/tray	35 x 29 x 24	180	7.2	8.7	6
HF3501A(Shroud)	25pcs/tray	35 x 29 x 24	150	5.3	7.1	6
HF3502	30pcs/tray	35 x 29 x 24	180	6.3	7.8	6
HF3503/HF3508	35pcs/box	35 x 29 x 24	210	8.4	9.9	6
HF3508A	25pcs/tray	35 x 29 x 24	150	5.3	7.1	6
HF3504/3507	30pcs/tray	35 x 29 x 24	180	6.9	8.4	6
HF3605	12pcs/box	40 x 32 x 22	60	5	7	6
HF3606	30pcs/tray	35 x 29 x 24	180	6.5	8.4	6

Notes: Specification and dimensions in this catalog are subject to change without notice.

## PACKING LIST(RELAYS)

Type	Packing Method	Carton Size L x W x H cm	QTY/CTN PCS	Approx. N.W. kg	Approx. G.W. kg	Stacking Layers Limit n
HF13F (1C, 2C,1, 2 type)	30pcs/tray	35 x 29 x 22	300	11.1	12.9	6
	20pcs/box	35 x 29 x 24	320	11.8	13.3	6
HF13F (1C, 2C,5 type)	30pcs/box	35 x 29 x 22	210	7.8	9.3	6
HF18FF (1, 2 type)	30pcs/tray	35 x 29 x 22	300	11.1	12.9	6
	20pcs/box	35 x 29 x 24	320	11.8	13.3	6
HF18FF (5 type)	30pcs/box	35 x 29 x 22	210	7.8	9.3	6
HF18FA	30pcs/tray	35 x 29 x 22	300	11.1	12.9	6
HF10FF	20pcs/tray	35 x 29 x 24	100	9.5	10.5	6
HF10FH	20pcs/tray	35 x 29 x 24	100	9.5	10.5	6
HF14FF	50pcs/tray	35 x 29 x 22	500	8.3	10.4	6
HF14FW	50pcs/tray	35 x 29 x 22	500	8.7	10.7	6
HF41F	100pcs/tube	60 x 19 x 15	2000	10.8	14.1	6
HF49FD	100pcs/tube	60 x 18 x 19	3000	9	12	7
HF115F	50pcs/tray	40 x 27 x 20	500	6.8	8.3	6
HF115F-A/HF115F Series	20pcs/tube	65 x 18 x 14	1000	13.5	15.5	5
HF115F-A	50pcs/box	39 x 23 x 22	500	6.8	8.3	6
HF115FP	50pcs/tray	35 x 29 x 24	500	9	10.5	6
HF118F	20pcs/tube	64 x 17 x 15	1000	8.2	10.2	8
HF140FF	50pcs/tray	35 x 29 x 22	500	8.5	10.6	6
HF141FF	50pcs/tray	35 x 29 x 22	500	7.3	9.3	6
HFA2	40pcs/tray	40 x 27 x 20	400	8	9.5	7
HFA4	30pcs/tray	40 x 27 x 24	300	6	7.5	6
HFA6	20pcs/tray	40 x 27 x 24	200	5	6.5	6
HF3701	1pcs/box	35 x 29 x 27	36	6	8.5	5

Notes: Specification and dimensions in this catalog are subject to change without notice.



HONGFA RELAY

ISO9001、ISO/TS16949、ISO14001、OHSAS18001、IECQ QC 080000 CERTIFIED

2015 Rev. 1.10

## PACKING LIST(RELAYS)

Type	Packing Method	Carton Size L x W x H cm	QTY/CTN PCS	Approx. N.W. kg	Approx. G.W. kg	Stacking Layers Limit n
HF13F (1C, 2C,1, 2 type)	30pcs/tray	35 x 29 x 22	300	11.1	12.9	6
	20pcs/box	35 x 29 x 24	320	11.8	13.3	6
HF13F (1C, 2C,5 type)	30pcs/box	35 x 29 x 22	210	7.8	9.3	6
HF18FF (1, 2 type)	30pcs/tray	35 x 29 x 22	300	11.1	12.9	6
	20pcs/box	35 x 29 x 24	320	11.8	13.3	6
HF18FF (5 type)	30pcs/box	35 x 29 x 22	210	7.8	9.3	6
HF18FA	30pcs/tray	35 x 29 x 22	300	11.1	12.9	6
HF10FF	20pcs/tray	35 x 29 x 24	100	9.5	10.5	6
HF10FH	20pcs/tray	35 x 29 x 24	100	9.5	10.5	6
HF14FF	50pcs/tray	35 x 29 x 22	500	8.3	10.4	6
HF14FW	50pcs/tray	35 x 29 x 22	500	8.7	10.7	6
HF41F	100pcs/tube	60 x 19 x 15	2000	10.8	14.1	6
HF49FD	100pcs/tube	60 x 18 x 19	3000	9	12	7
HF115F	50pcs/tray	40 x 27 x 20	500	6.8	8.3	6
HF115F-A/HF115F Series	20pcs/tube	65 x 18 x 14	1000	13.5	15.5	5
HF115F-A	50pcs/box	39 x 23 x 22	500	6.8	8.3	6
HF115FP	50pcs/tray	35 x 29 x 24	500	9	10.5	6
HF118F	20pcs/tube	64 x 17 x 15	1000	8.2	10.2	8
HF140FF	50pcs/tray	35 x 29 x 22	500	8.5	10.6	6
HF141FF	50pcs/tray	35 x 29 x 22	500	7.3	9.3	6
HFA2	40pcs/tray	40 x 27 x 20	400	8	9.5	7
HFA4	30pcs/tray	40 x 27 x 24	300	6	7.5	6
HFA6	20pcs/tray	40 x 27 x 24	200	5	6.5	6
HF3701	1pcs/box	35 x 29 x 27	36	6	8.5	5

Notes: Specification and dimensions in this catalog are subject to change without notice.



HONGFA RELAY

ISO9001、ISO/TS16949、ISO14001、OHSAS18001、IECQ QC 080000 CERTIFIED

2015 Rev. 1.10

## PACKING LIST

Type	Packing Method	Carton Size L x W x H cm	QTY/CTN PCS	Approx. N.W. kg	Approx. G.W. kg	Stacking Layers Limit n
HFE6	1 pcs/box	34.5 x 28.5 x 23.5	24	8.2	9.4	6
HFE7	30 pcs/tube	54 x 20 x 14	1200	7.2	10.2	8
HFE7	100 pcs/box	36 x 26 x 25	1000	6	7.1	6
HFE8	100 pcs/box	31.5 x 26 x 24	1000	4	5.7	6
HFE9	25 pcs/box	34.5 x 28.5 x 23.5	200	6	7.6	6
HFE10	50 pcs/box	37 x 26 x 25	400	11.2	13.2	6
HFE10-L	35 pcs/box	36 x 33 x 29	420	12.6	14.7	5
HFE12	10 pcs/box	34.5 x 28.5 x 21	60	4.5	5.6	7
HFE17	6 pcs/box	53 x 35 x 29	24	10.1	12.7	5
HFE19-60	25 pcs/box	34.5 x 28.5 x 23.5	200	6.2	7.8	6
HFE19-60(391)	20 pcs/box	36.5 x 33 x 35.5	200	8	10	4
HFE19-80(391)	20 pcs/box	36.5 x 33 x 35.5	200	8.4	10.4	4
HFE19-90	25 pcs/box	34.5 x 28.5 x 23.5	200	6.2	7.8	6
HFE19-100	20 pcs/box	36.5 x 33 x 35.5	200	13	15	4
HFE20	80 pcs/box	33 x 24 x 22	800	10.4	12	6
HFE21	16 pcs/tray	36 x 33 x 29	160	13.7	16	5
HFE22	10 pcs/box	34.5 x 28.5 x 23.5	60	5.4	6.8	6
HFE23	4 pcs/tray	36 x 30.5 x 40	36	10.8	13.0	3
HFE25	6 pcs/box	54 x 36 x 32	36	15.2	18	4
HFE26	24 pcs/box	36 x 33 x 29	312	9.5	11.5	5
HFE27	16 pcs/box	36 x 33 x 29	224	8.5	10.9	5
HFE28	6 pcs/box	55 x 36.5 x 29	48	14	17	5
HFE29	16 pcs/box	36 x 33 x 29	112	10	11.6	5
HFE30	6 pcs/box	42 x 32 x 32	60	13	15	4
HFE31	12 pcs/box	36 x 33 x 29	60	11.1	13.1	5
HFE33	110 pcs/box	33 x 24 x 22	1100	7.7	9.3	6
HFE36	4 pcs/box	36 x 33 x 30.5	24	7	8.5	4

Notes: Specification and dimensions in this catalog are subject to change without notice.



HONGFA RELAY

ISO9001, ISO/TS16949, ISO14001, OHSAS18001, IECQ QC 080000 CERTIFIED

2015 Rev. 1.00

## PACKING LIST

Type	Packing Method	Carton Size L x W x H cm	QTY/CTN PCS	Approx. N.W. kg	Approx. G.W. kg	Stacking Layers Limit n
HF3FA	100pcs/box	34 x 22 x 14.5	1000	8	10	8
HF3FD	100pcs/box	36 x 24 x 16	1000	10	12	7
HF3FF	100pcs/box	34 x 22 x 14.5	1000	10	12	7
HF7FD(double pin)	32pcs/tube	63 x 15 x 16	800	7.4	11.2	7
HF7FD	20pcs/tube	40 x 31 x 22	1000	9.3	13.1	6
HF7FD	100pcs/box	46 x 31 x 19	1000	9.3	11.1	7
HF7FF	20pcs/tube	40 x 30 x 22	1000	10	11.5	6
HF8	20pcs/tube	40 x 31 x 22	1000	9.3	13.1	6
HF8A	20pcs/tube	40 x 31 x 22	1000	9.4	13.2	6
HF14FF	50pcs/tray	35 x 29 x 22	500	8.7	10.5	6
HF14FW	50pcs/tray	35 x 29 x 22	500	8.7	10.5	6
HF21FF	30pcs/tube	56 x 29 x 20	1500	19.4	23.2	4
HF25F	50pcs/tray	35 x 29 x 17	500	7.4	9.1	6
HF32FV	100pcs/box	32 x 26 x 19	1000	6	7.5	7
HF32F	100pcs/box	32 x 26 x 19	1000	6	7.5	7
HF32F-G	100pcs/box	32 x 26 x 19	1000	6	7.5	7
HF32FA	100pcs/box	34 x 28 x 21	1000	6	7.5	7
HF32FA-T	100pcs/box	34 x 28 x 21	1000	6	7.5	7
HF32FA-G	100pcs/box	34 x 28 x 21	1000	6	7.5	7
HF33F	100pcs/box	32 x 26 x 19	1000	6	7.5	7
HF36F	20pcs/tube	56 x 39 x 18	1000	12	14.5	6
HF36FD	50pcs/box	38 x 30 x 27	1000	9.6	11.4	5
HF37F	25pcs/tray	35 x 29 x 24	100	5.5	7	6
HF41F	100pcs/tube	60 x 19 x 14	2000	10.8	14.1	6
HF42F	50pcs/box	39 x 34 x 25	1000	14.5	16.3	5
HF46F	150pcs/box	34 x 28 x 21	1500	6	7.5	7
HF46F-G	150pcs/box	34 x 28 x 21	1500	6	7.5	7
HF49FD	100pcs/tube	60 x 18 x 18	3000	9	12	7
HF62F	50pcs/tray	35 x 29 x 22	500	7.5	9.3	6
HF62F(1HT)	50pcs/tray	35 x 29 x 22	500	7.5	9.3	6
HF84F/HF94F	1pcs/box	36 x 36 x 22	100	8.5	10	6
HF84F/HF94F	25pcs/tray	36 x 36 x 22	100	8.5	10	6

**Notes:** This above list is the typical packing specification. Specifications and dimensions in this catalog are subject to change without notice.



Type	Packing Method	Carton Size L x W x H cm	QTY/CTN PCS	Approx. N.W. kg	Approx. G.W. kg	Stacking Layers Limit n
HF92F	20pcs/tray	35 x 29 x 24	100	8.6	10.1	6
HF102F	50pcs/box	40 x 27 x 18	400	9.2	10.7	8
HF105-1/-1L (Unenclosed)	50pcs/tray	35 x 29 x 22	350	8.5	10	6
HF105F-1/-1L	40pcs/tray	35 x 29 x 22	240	8.5	10	6
HF105F-2/-2L	40pcs/tray	35 x 29 x 24	240	7.5	9	6
HF105F-4	40pcs/tray	35 x 29 x 24	240	8.5	10	6
HF105F-4L	40pcs/tray	35 x 29 x 24	240	8.5	10	6
HF105F-5/-5L	40pcs/tray	35 x 29 x 24	240	7.5	9	6
HF115F	20pcs/tube	65 x 18 x 14	1000	13.5	15.5	5
HF115F/-H/-I/-T/-TH/-L/FD	50pcs/tray	40 x 27 x 20	500	6.8	8.3	7
HF115F-A/-H/-I/-T/-TH	20pcs/tube	65 x 18 x 14	1000	13.5	15.5	5
HF115F-Q	40pcs/tray	35 x 29 x 24	400	6.5	8	6
HF115FP	50pcs/tray	35 x 29 x 24	500	9	10.5	6
HF115FD	20pcs/tube	65 x 18 x 14	1000	13.5	15.5	5
HF115FD	50pcs/tray	40 x 27 x 20	500	6.8	8.3	7
HF115FK	20pcs/tube	65 x 18 x 14	1000	13.5	15.5	5
HF115FK	50pcs/tray	40 x 27 x 20	500	6.8	8.3	7
HF115FK-T	20pcs/tube	65 x 18 x 14	1000	13.5	15.5	5
HF115FK-T	50pcs/tray	40 x 27 x 20	500	6.8	8.3	7
HF116F-1	16pcs/tray	35 x 29 x 24	80	9.6	11.1	6
HF116F-2	16pcs/tray	35 x 29 x 24	80	9.6	11.1	6
HF116F-3 (A type)	5pcs/box	32 x 17 x 19	50	6	7.5	7
HF116F-3 (F type)	5pcs/box	33 x 19 x 19	50	6	7.5	7
HF118F	20pcs/tube	64 x 17 x 15	1000	8.2	10.2	8
HF140FF	50pcs/tray	35 x 29 x 22	500	8.8	10.6	6
HF141FF	50pcs/tray	35 x 29 x 22	500	6.7	8.5	6
HF152F	50pcs/box	45 x 30 x 22	1000	12.2	14	6
HF152F	25pcs/tube	50 x 22 x 19	1000	12.2	16	5
HF158F	20pcs/tube	65 x 18 x 14	1000	13.5	15.5	5
HF158F	50pcs/tray	40 x 27 x 20	500	6.8	8.3	7
HF160F	50pcs/box	40 x 27 x 20	400	10.5	12	7

**Notes:** This above list is the typical packing specification. Specifications and dimensions in this catalog are subject to change without notice.

Type	Packing Method	Carton Size L x W x H cm	QTY/CTN PCS	Approx. N.W. kg	Approx. G.W. kg	Stacking Layers Limit n
HF161F	50pcs/tray	40 x 27 x 18	400	8.4	9.9	8
HF161F-W	50pcs/tray	40 x 27 x 18	400	8.4	14	6
HF162F	50pcs/box	41 x 35 x 28	1000	11	12.8	5
HF163F-L	40pcs/tube	48.5 x 17 x 18.5	1000	7	9.3	8
HF165F	35pcs/reel	40 x 27 x 17.5	280	7.9	9.19	8
HF2100/HF2101	40pcs/tray	35 x 29 x 24	240	8.5	10	6
HF2110/HF2111	50pcs/tray	35 x 29 x 24	350	9	10.5	6
HF2120	40pcs/tray	35 x 29 x 22	200	6.5	8	6
HF2150/HF2151	40pcs/tray	35 x 29 x 24	280	8	9.5	6
HF2160/HF2161	40pcs/tray	35 x 29 x 24	240	8	9.5	6
HF7520	50pcs/box	47 x 33 x 18	1000	8.6	10.4	8
HF8565 (Shroud)	10pcs/box	40 x 31 x 22	90	10.2	12	6
HF8565 (Twisted wire)	20pcs/box	35 x 30 x 24	40	4.4	6	6
HFE7	30pcs/tube	54 x 20 x 14	1200	7.2	10.2	8
HFE7	100pcs/box	36 x 26 x 25	1000	6	7.1	6
HFD2	25pcs/tube	58 x 29 x 24	4000	18	24	4
HFD3(SMT type)	400pcs/reel	35 x 35 x 18	2000	4	8	8
HFD3	40pcs/tube	68 x 19 x 23	4000	8	13	6
HFD4(SMT type)	900pcs/reel	37 x 37 x 22	3600	2.9	8	6
HFD4	50pcs/tube	58 x 18 x 16	4000	3.2	9	9
HFD23	20pcs/tube	35 x 29 x 24	4000	8.8	10.8	6
HFD27	25pcs/tube	58 x 29 x 24	4000	20	27	3
HFD31	40pcs/tube	64 x 22 x 20	4000	12.8	15	6
HFD31(SMT type)	550pcs/reel	37 x 37 x 22	2200	7	8.8	7
HFD3-V(SMT type)	400pcs/reel	35 x 35 x 18	2000	4	8	8
HFD3-V	40pcs/tube	68 x 19 x 23	4000	8	13	6
HFD41/HFD41A	100pcs/box	45 x 32 x 18	2000	7	8.8	8

**Notes:** This above list is the typical packing specification. Specifications and dimensions in this catalog are subject to change without notice.



HONGFA RELAY

ISO9001, ISO/TS16949, ISO14001, OHSAS18001, IECQ QC 080000 CERTIFIED

2016 Rev. 1.00

## PACKING LIST(RELAY SOCKETS)

Type	Packing method	Carton Size L x W x H cm	QTY/CTN PCS	Approx.G.W. kg
13F-2Z-A2	20 pcs/box	34 x 28 x 20	600	7.1
13F-2Z-C1	5 pcs/box	34 x 28 x 20	150	9.1
13F-2Z-C2	5 pcs/box	34 x 28 x 20	150	9.3
18FF-2Z-A2	20 pcs/box	34 x 28 x 20	600	6.5
18FF-2Z-C1	6 pcs/box	34 x 28 x 20	180	7.9
18FF-2Z-C2	6 pcs/box	34 x 28 x 20	180	7.8
18FF-2Z-C4	30 pcs/box	34 x 28 x 23	120	8.3
18FF-2Z-C5	30 pcs/box	34 x 28 x 23	90	7.6
18FF-2Z-C6	80 pcs/box	34 x 28 x 23	240	10.0
18FF-2Z-C7	80 pcs/box	34 x 28 x 23	240	11.5
18FF-2Z-C8	30 pcs/box	34 x 28 x 23	120	6.9
18FF-3Z-C1	5 pcs/box	34 x 28 x 20	150	8.7
18FF-3Z-C4	30 pcs/box	34 x 28 x 23	120	9.0
18FF-3Z-C5	30 pcs/box	34 x 28 x 23	90	7.9
18FF-4Z-A2	20 pcs/box	34 x 28 x 20	600	6.8
18FF-4Z-C1	5 pcs/box	34 x 28 x 20	150	9.6
18FF-4Z-C2	5 pcs/box	34 x 28 x 20	150	10.0
18FF-4Z-C4	30 pcs/box	34 x 28 x 23	120	9.2
18FF-4Z-C5	30 pcs/box	34 x 28 x 23	90	8.3
18FF-4Z-C6	80 pcs/box	34 x 28 x 23	240	12.9
18FF-4Z-C7	80 pcs/box	34 x 28 x 23	240	13.8
18FF-4Z-C8	30 pcs/box	34 x 28 x 23	120	8.0
10FF-2Z-C1	100 pcs/box	34 x 28 x 23	300	12.3
10FF-2Z-C2	90 pcs/box	34 x 28 x 23	270	12.0
10FF-2Z-C3	60 pcs/box	34 x 28 x 23	180	10.1
10FF-2Z-C4	36 pcs/box	34 x 28 x 23	144	9.8
10FF-3Z-C1	56 pcs/box	34 x 28 x 23	168	9.9
10FF-3Z-C2	56 pcs/box	34 x 28 x 23	168	10.5



HONGFA RELAY

ISO9001、ISO/TS16949、ISO14001、OHSAS18001、IECQ QC 080000 CERTIFIED

2016 Rev. 1.00

## PACKING LIST(RELAY SOCKETS)

Type	Packing method	Carton Size L x W x H cm	QTY/CTN PCS	Approx.G.W. kg
10FF-3Z-C3	60 pcs/box	34 x 28 x 23	180	10.7
10FF-3Z-C4	36 pcs/box	34 x 28 x 23	144	10.6
49F/49FA	160 pcs/box	33 x 26 x 19	1600	2.5
14FF-1Z-A1	40 pcs/tube	34 x 28 x 23	2000	9.8
14FF-1Z-C2	50 pcs/box	34 x 28 x 23	200	8.7
14FF-1Z-C3	50 pcs/box	34 x 28 x 23	150	7.7
14FF-2Z-A1	40 pcs/tube	34 x 28 x 23	2000	9.8
14FF-2Z-C2	50 pcs/box	34 x 28 x 23	200	9.7
14FF-2Z-C3	50 pcs/box	34 x 28 x 23	150	8.4
14FF-2Z-C4	40 pcs/box	34 x 28 x 23	160	9.5
140FF-2Z-C3	50 pcs/box	34 x 28 x 23	150	7.3
41F-1Z-C2	10 pcs/box	34 x 28 x 23	300	8.8
41F-1Z-C4	10 pcs/box	34 x 28 x 23	300	8.8
118F-1Z-A1-1	40 pcs/tube	34 x 28 x 23	2000	9.8
118F-1Z-A1-2	40 pcs/tube	34 x 28 x 23	2000	9.8
118F-1Z-A1	40 pcs/tube	34 x 28 x 23	2000	9.8

**Notes:** This table is just for reference.if you have any questions,please contact us.



HONGFA RELAY

ISO9001、ISO/TS16949、ISO14001、OHSAS18001、IECQ QC 080000 CERTIFIED

Реле HONGFA, купить в Минске tel. +375447584780  
www.fotorele.net www.tiristor.by радиодетали, электронные компоненты  
email minsk17@tut.by tel.+375 29 758 47 80 МТС

Реле HONGFA, аналог, замена, Минск, каталог, описание, технические, характеристики,  
datasheet, параметры, маркировка, габариты, фото,

QR код

