

Slimline PCB Relay SNR

- 1 pole 6A, 1 form C (CO), 1 form A (NO)
- Only 5mm wide
- Flat pack version available
- Sensitive coil 170mW
- Reinforced insulation (protection classII)
- Strong coil pins for DIN-rail socket
- Allows high function- / packaging density
- Cadmium-free contacts, AgNi 90/10 for AC-loads



F0140-D

Typical applications
Interface technology, PLC's, timers, centralized and decentralized heating control



Approvals

VDE REG.-Nr. 6666, UL E214024
Technical data of approved types on request

Contact Data

Contact arrangement	1 form C (CO) or 1 form A (NO)	
Rated voltage	250VAC	
Max. switching voltage	400VAC	
Rated current	6A	
Limiting making current, max 4s, df 10%	10A	
Breaking capacity max.	1500VA	
Contact material	AgSnO ₂ , AgNi 90/10	AgSnO ₂ gold plated
Min. recommended contact load	100mA, 12V	50mW
Frequency of operation, with/without load	6/1200min ⁻¹	
Operate/release time max.	12/5ms	
Bounce time max., form A/form B	3/8ms	

Contact ratings

Type	Contact	Load	Cycles
EC 61810			
V23092-****-A301, -A801	C (CO)	6A, 250VAC, cosφ=1, 85°C	5x10 ³
UL 508			
V23092-****-A301, -A801	A/B	6A, 250VAC, general purpose, 85°C	6x10 ³
V23092-****-A301, -A801	A/B	B300, 85°C	6x10 ³
V23092-****-A301, -A801	A/B	R300, 85°C	6x10 ³
EN60730-1			
V23092-****-A302	A (NO)	3A (1.5A), 250VAC, 85°C	100x10 ³
V23092-****-A302, -A802	A (NO)	5A (1.5A), 250VAC, 85°C	10x10 ³

Mechanical endurance, DC coil 10x10⁶ operations

Coil Data

Coil voltage range	5 to 60VDC
Operative range, IEC 61810	2

Coil versions, DC coil

Coil code	Rated voltage VDC	Operate voltage VDC	Release voltage VDC	Coil resistance Ω±10% ¹⁾	Rated power mW
005	5	3.5	0.25	147	170
012	12	8.4	0.6	848	170
024	24	16.8	1.2	3390	170
048	48	33.6	2.4	10600 ¹⁾	217
060	60	42.0	3.0	20500 ¹⁾	176

1) Coil resistance ±15%.
All figures are given for coil without pre-energization, at ambient temperature +23°C.
Other coil voltages on request.

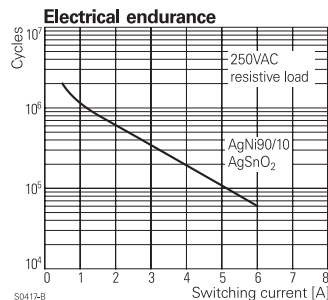
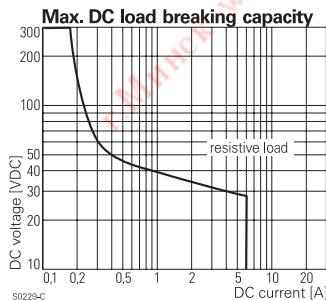
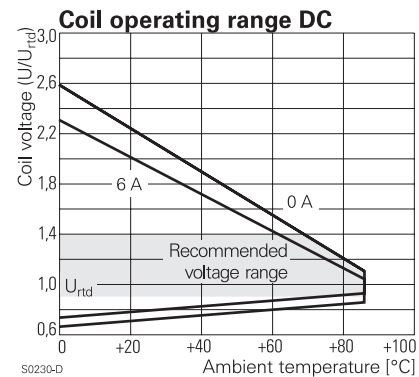

Insulation Data

Initial dielectric strength	
between open contacts	1000V _{rms}
between contact and coil	4000V _{rms}
Clearance/creepage	
between contact and coil	≥6/8mm
Material group of insulation parts	IIIa
Tracking index of relay base	PTI250

Slimline PCB Relay SNR (Continued)

Other Data

Material compliance: EU RoHS/ELV, China RoHS, REACH, Halogen content refer to the Product Compliance Support Center at www.te.com/customersupport/rohssupportcenter

Ambient temperature	-40 to +85°C
Category of environmental protection	RTIII - wash tight
IEC 61810	
Vibration resistance (functional), form A (NO) / form B (NC)	10/5g
Shock resistance (functional), form A (NO) / form B (NC)	10/5g
Shock resistance (destructive)	30g
Terminal type	PCB-THT, plug-in
Mounting	PCB, socket
Weight	6g
Resistance to soldering heat THT IEC 60068-2-20	260°C/5s ²⁾
Packaging unit	tube/20 pcs., box/1000 pcs.

2) for flat pack version selective soldering is recommended

Accessories

For details see datasheet [Accessories Slim Interface Relay SNR](#)

PCB layout / terminal assignment

Bottom view on solder pins

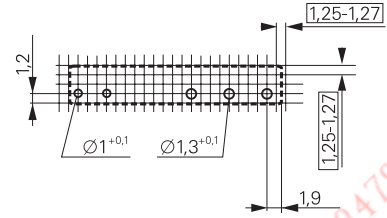

S0258-AA

1 form C contact (1 CO)

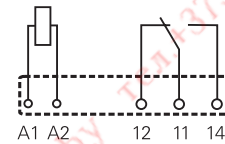

S0258-AB

1 form A contact (1 NO)

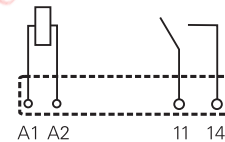

S0258-AC

Dimensions

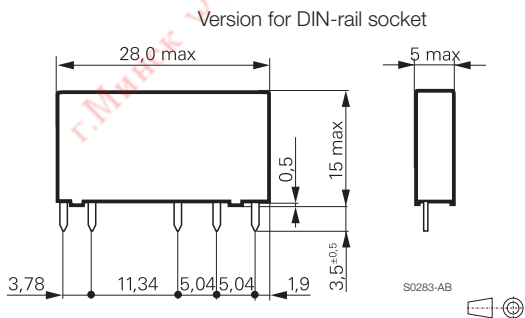
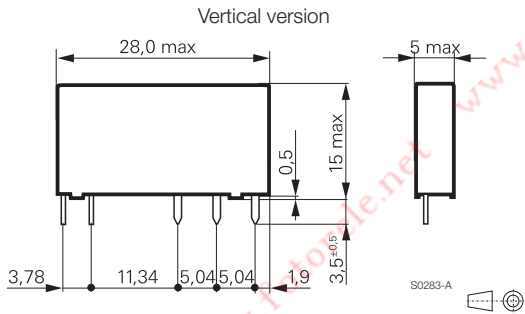

Flat pack version²⁾

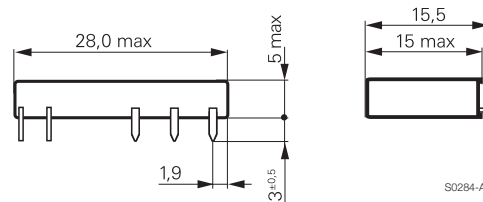

2) for flat pack version selective soldering is recommended

Slimline PCB Relay SNR (Continued)

Product code structure		Typical product code		V23092	-A	1	005	-A	3	01
Type		V23092 Slimline PCB relay SNR								
Version		A PCB, vertical version B PCB, flat pack version S Plug-in, vertical version								
Version		1 Wash tight								
Coil		Coil code: please refer to coil versions table								
Contact system		A Standard								
Contact material		2 AgSnO ₂ , gold plated 3 AgSnO ₂ 8 AgNi 90/10								
Contact configuration		01 1 form C contact (1 CO) 02 1 form A contact (1 NO)								

NO version with 8/8mm clearance and creepage and other types on request

Product code	Version	Contact arrangement	Contact material	Coil	Part number
V23092-A1005-A201	PCB	1 form C (CO) contact	AgSnO ₂ , gold plated	5VDC	1393236-1
V23092-A1005-A202	vertical version	1 form A (NO) contact			8-1415067-1
V23092-A1005-A301	wash tight	1 form C (CO) contact	AgSnO ₂		1393236-2
V23092-A1005-A302		1 form A (NO) contact			9-1415067-1
V23092-A1005-A801		1 form C (CO) contact	AgNi 90/10		1-1415068-1
V23092-A1005-A802		1 form A (NO) contact			1415068-1
V23092-A1012-A201		1 form C (CO) contact	AgSnO ₂ , gold plated	12VDC	1393236-4
V23092-A1012-A202		1 form A (NO) contact			1393236-5
V23092-A1012-A301		1 form C (CO) contact	AgSnO ₂		1393236-7
V23092-A1012-A302		1 form A (NO) contact			1393236-8
V23092-A1012-A801		1 form C (CO) contact	AgNi 90/10		1-1393236-3
V23092-A1012-A802		1 form A (NO) contact			2-1415068-1
V23092-A1024-A201		1 form C (CO) contact	AgSnO ₂ , gold plated	24VDC	2-1393236-1
V23092-A1024-A202		1 form A (NO) contact			2-1393236-2
V23092-A1024-A301		1 form C (CO) contact	AgSnO ₂		2-1393236-4
V23092-A1024-A302		1 form A (NO) contact			2-1393236-5
V23092-A1024-A801		1 form C (CO) contact	AgNi 90/10		3-1393236-0
V23092-A1024-A802		1 form A (NO) contact			5-1415063-1
V23092-A1048-A201		1 form C (CO) contact	AgSnO ₂ , gold plated	48VDC	3-1393236-5
V23092-A1048-A202		1 form A (NO) contact			3-1393236-6
V23092-A1048-A301		1 form C (CO) contact	AgSnO ₂		3-1393236-7
V23092-A1048-A302		1 form A (NO) contact			3-1393236-8
V23092-A1048-A801		1 form C (CO) contact	AgNi 90/10		3-1393236-9
V23092-A1048-A802		1 form A (NO) contact			3-1415068-1
V23092-S1005-A201	Plug-in	1 form C (CO) contact	AgSnO ₂ , gold plated	5VDC	1956024-9
V23092-S1005-A301	vertical version		AgSnO ₂		1-1956024-0
V23092-S1012-A201	wash tight		AgSnO ₂ , gold plated	12VDC	1956024-1
V23092-S1012-A301			AgSnO ₂		1956024-2
V23092-S1024-A201			AgSnO ₂ , gold plated	24VDC	1956024-3
V23092-S1024-A301			AgSnO ₂		1956024-4
V23092-S1048-A201			AgSnO ₂ , gold plated	48VDC	1956024-5
V23092-S1048-A301			AgSnO ₂		1956024-6
V23092-S1060-A201			AgSnO ₂ , gold plated	60VDC	1956024-7
V23092-S1060-A301			AgSnO ₂		1956024-8

Реле Finder Минск т.80447584780

www.fotorele.net www.tiristor.by

email minsk17@tut.by tel.+375 29 758 47 80 МТС

каталог, описание, finder, реле, технические, характеристики, datasheet, параметры, маркировка, габариты, фото, даташит, аналог, замена, Беларусь

Реле, каталог, описание, технические, характеристики, datasheet, параметры, маркировка, габариты, фото, даташит, finder, финдер, V23092



реле

**реле электромеханическое
электронные компоненты
где и как купить в Минске?**

Результат поискового запроса «V23092» на einfo.ru

Компонент	Описание
V23092-A1005-A301 (заказ 3 дня)	TE, 20
V23092-A1012-A301 (заказ 3 дня)	TE, 20 R_SNR
V23092-A1012-A201	TE Connectivity, RELAY GEN PURPOSE SPDT 6A 12V
V23092-A1012-A301	TE CONNECTIVITY / SCHRACK, Relay Type:Power; Coil Voltage VDC Nom:12V; Contact Current Max:6A; Contact Voltage AC Nom:250V; Coil Resistance:848ohm;
V23092-A1012-A301	

V23092-A1012-A301	TE Connectivity, RELAY GEN PURPOSE SPDT 6A 12V
V23092-A1024-A301	TE CONNECTIVITY / SCHRACK, Relay Type:Power; Coil Voltage VDC Nom:24V; Contact Current Max:6A; Contact Voltage AC Nom:250V; Coil Resistance:3.39kohm;
V23092-A1024-A301	TE Connectivity, RELAY GEN PURPOSE SPDT 6A 24V
V23092-A1024-A302	TE CONNECTIVITY / SCHRACK, Relay Type:Power; Coil Voltage VDC Nom:24V; Contact Current Max:6A; Contact Voltage AC Nom:250V; Coil Resistance:3.39kohm;
V23092-A1024-A302	TE Connectivity, RELAY GEN PURPOSE SPST 6A 24V
V23092-A1024-A302	
V23092-A1905-A301	TE CONNECTIVITY / SCHRACK, Relay Type:General Purpose; Coil Voltage VDC Nom:5V; Contact Current Max:6A; Contact Voltage AC Nom:240V; Coil Resistance:148ohm;
V23092-A1905-A302	TE CONNECTIVITY, Relay Type:General Purpose; Coil Voltage VDC Nom:5V; Contact Current Max:6A; Contact Voltage AC Nom:240V; Coil Resistance:148ohm;
V23092A1024A201	TE Connectivity, RELAY GEN PURPOSE SPDT 6A 24V
V23092-A1012-A301 (37-205-13)	ED, Эл-мех.компоненты-Пневм.компоненты Реле Реле на печатную плату-Relay 1-pole V23092 12VDC
V23092-A1024-A301 (37-205-21)	ED, Эл-мех.компоненты-Пневм.компоненты Реле Реле на печатную плату-Relay 1-pole V23092 24VDC
V23092-A1905-A301 (37-205-05)	ED, Эл-мех.компоненты-Пневм.компоненты Реле Реле на печатную плату-Relay 1-pole V23092 5VDC
V23092-A1005-A301	TE Connectivity Potter & Brumfield Relays, RELAY GENERAL PURPOSE SPDT 6A 5V. Мин.: 8шт.
V23092-A1005-A301	TE Connectivity, General Purpose Relays V23092-A1005-A301. Мин.: 4шт.
V23092-A1005-A301	TE Connectivity, . Мин.: 24шт.
V23092-A1012-A201	TE Connectivity, General Purpose Relays. Мин.: 4шт.
V23092-A1012-A201	TE Connectivity Potter & Brumfield Relays, RELAY GEN PURPOSE SPDT 6A 12V. Мин.: 5шт.
V23092-A1012-A301	TE Connectivity, R_SNR. Мин.: 32шт.
V23092-A1012-A301	TE Connectivity Potter & Brumfield Relays, RELAY GEN PURPOSE SPDT 6A 12V. Мин.: 6шт.
V23092-A1012-A302	TE Connectivity, General Purpose Relays PCB SPNO 12VDC. Мин.: 5шт.
V23092-A1024-A201	TE Connectivity Potter & Brumfield Relays, RELAY GEN PURPOSE SPDT 6A 24V. Мин.: 5шт.
V23092-A1024-A201	TE Connectivity, . Мин.: 22шт.
V23092-A1024-A201	TE Connectivity Potter & Brumfield Relays, RELAY GEN PURPOSE SPDT 6A 24V. Мин.: 400шт.
V23092-A1024-A201	TE Connectivity, General Purpose Relays RELAY SPDT 6A 24VDC. Мин.: 4шт.
V23092-A1024-A301	TE Connectivity Potter & Brumfield Relays, RELAY GEN PURPOSE SPDT 6A 24V. Мин.: 8шт.
V23092-A1024-A302	TE Connectivity, General Purpose Relays SPST-NO 1 N/O 24vdc. Мин.: 6шт.
V23092-A1024-A302	TE Connectivity Potter & Brumfield Relays, RELAY GEN PURPOSE SPST 6A 24V. Мин.: 6шт.
V23092-A1024-A801	TE Connectivity Potter & Brumfield Relays, RELAY GEN PURPOSE SPDT 6A 24V. Мин.: 6шт.
V23092-A1060-A301	TE Connectivity Potter & Brumfield Relays, RELAY GEN PURPOSE SPDT 6A 60V. Мин.: 6шт.
V23092-B1024-A301	TE Connectivity Potter & Brumfield Relays, RELAY GEN PURPOSE SPDT 6A 24V. Мин.: 6шт.
V23092A1005A201	TE Connectivity, . Мин.: 18шт.
V23092A1005A301	TE Connectivity Potter & Brumfield Relays, RELAY GENERAL PURPOSE SPDT 6A 5V. Мин.: 6шт.
V23092A1012A201	TE Connectivity Potter & Brumfield Relays, RELAY GEN PURPOSE SPDT 6A 12V. Мин.: 4шт.

V23092A1012A301	TE Connectivity Potter & Brumfield Relays, RELAY GEN PURPOSE SPDT 6A 12V. Мин.: 3шт.
V23092A1012A301	TE Connectivity, General Purpose Relays 12V 6A 1CO THT POWER RELAY. Мин.: 3шт.
V23092A1012A302	TE Connectivity Potter & Brumfield Relays, RELAY GEN PURPOSE SPST 6A 12V. Мин.: 6шт.
V23092A1012A801	TE Connectivity Potter & Brumfield Relays, RELAY GEN PURPOSE SPDT 6A 12V. Мин.: 9шт.
V23092A1024A201	TE Connectivity Potter & Brumfield Relays, RELAY GEN PURPOSE SPDT 6A 24V. Мин.: 4шт.
V23092A1024A301	TE Connectivity Potter & Brumfield Relays, RELAY GEN PURPOSE SPDT 6A 24V. Мин.: 8шт.
V23092A1024A301	TE Connectivity, General Purpose Relays RELAY 100. Мин.: 8шт.
V23092A1024A302	TE Connectivity Potter & Brumfield Relays, RELAY GEN PURPOSE SPST 6A 24V. Мин.: 8шт.
V23092A1048A201	TE Connectivity Potter & Brumfield Relays, RELAY GEN PURPOSE SPDT 6A 48V. Мин.: 6шт.
V23092A1048A302	TE Connectivity Potter & Brumfield Relays, RELAY GEN PURPOSE SPST 6A 48V. Мин.: 7шт.
V23092A1905A201	TE Connectivity Potter & Brumfield Relays, RELAY GEN PURP. Мин.: 5шт.
V23092A1905A301	TE Connectivity Potter & Brumfield Relays, RELAY GENERAL PURPOSE SPDT 6A 5V. Мин.: 6шт.
V23092-A1005-A301	TE, Реле электромеханическое
V23092-A1012-A301	TE, Реле электромеханическое
V23092-A1024-A201	TE, Реле электромеханическое
V23092A1005A201	TE, Реле электромеханическое
V23092-A1005-A301	TYCO
V23092-A1012-A201	TYCO
V23092-A1012-A301	TYCO
V23092-A1012-A302	TYCO
V23092-A1024-A201	TYCO
V23092-A1024-A301	TYCO
V23092-A1024-A302	TYCO
V23092A1005A201	TYCO
1-1415068-1, V23092-A1005-A801 реле 1-Form-C,SPST-CO,1NO 5VDC/6A	TE Connectivity, Заказ от 1 шт.
1393236-5, V23092-A1012-A202 реле	TE Connectivity
1393236-7, V23092-A1012-A301 реле 1-Form-C, SPDT, 1CO 12VDC/6A моност.	TE Connectivity, Заказ от 1 шт.
1415068-1, V23092-A1005-A802 реле 1 Form A,SPST-NO,1NO 5VDC/6A	TE Connectivity, Заказ от 1 шт.
2-1393236-1, V23092A1024A201 реле 1C; 24 В DC; 170 мВт	TE Connectivity, Заказ от 1 шт.
4-1393236-2, V23092-A1060-A201 реле 1-Form-C,SPDT,1CO 60VDC/6A	TE Connectivity, Заказ от 1 шт.
4-1393236-3, V23092-A1060-A301 реле 1-Form-C,SPDT,1CO 60VDC/6A	TE Connectivity, Заказ от 1 шт.
6-1393236-8, V23092-B1005-A301 реле угл.1C 5B dc	TE Connectivity, Заказ от 1 шт.
7-1393236-1, V23092-B1012-A301 реле 1 Form C 12B 6A/250B	TE Connectivity, Заказ от 1 шт.
1-1415068-1, V23092-A1005-A801 реле 1-Form-C,SPST-CO,1NO 5VDC/6A	TE Connectivity, оптовая цена от 100 шт.
1393236-5, V23092-A1012-A202 реле	TE Connectivity, оптовая цена от 20 шт.
1393236-7 V23092-A1012-A301	TE Connectivity, оптовая цена от 40 шт.
1393236-7, V23092-A1012-A301 реле 1-Form-C, SPDT, 1CO 12VDC/6A моност.	TE Connectivity, оптовая цена от 1000 шт.
1393236-8 V23092A1012A302	TE Connectivity, оптовая цена от 80 шт.
1415068-1, V23092-A1005-A802 реле 1 Form A,SPST-NO,1NO 5VDC/6A	TE Connectivity, оптовая цена от 80 шт.
2-1393236-1, V23092A1024A201 реле 1C; 24 В DC; 170 мВт	TE Connectivity, оптовая цена от 200 шт.
4-1393236-2, V23092-A1060-A201 реле 1-Form-C,SPDT,1CO 60VDC/6A	TE Connectivity, оптовая цена от 200 шт.

4-1393236-3, V23092-A1060-A301 реле 1-Form-C,SPDT,1CO 60VDC/6A	TE Connectivity, оптовая цена от 100 шт.
5-1393236-7 V23092A1905A301	TE Connectivity, оптовая цена от 61 шт.
6-1393236-8 V23092-B1005-A301	TE Connectivity, оптовая цена от 20 шт.
6-1393236-8, V23092-B1005-A301 реле угл.1C 5B dc	TE Connectivity, оптовая цена от 800 шт.
7-1393236-1 V23092-B1012-A301	TE Connectivity, оптовая цена от 80 шт.
7-1393236-1, V23092-B1012-A301 реле 1 Form C 12B 6A/250B	TE Connectivity, оптовая цена от 1000 шт.
V23092-A1012-A301 R_SNR	TE, оптовая цена от шт.
V23092-A1012-A301	TE, R_SNR
Реле Schrack V23092-A1012-A303 (12V)	
Реле Siemens V23092-A1012-A302 (12V)	
Реле Siemens V23092-A1048-A201 (48V)	
1393236-7 (V23092A1012A301)	TE CONNECTIVITY
1-1415068-1. V23092-A1005-A801 реле 1-Form-C.SPST-CO.1NO 5VDC/6A /TE/ цена от 100 шт	TE
1393236-5. V23092-A1012-A202 реле /TE/ цена от 20 шт	TE
1393236-7. V23092-A1012-A301 реле 1-Form-C. SPDT. 1CO 12VDC/6A моност. /TE/ цена от 1000 шт	TE
1415068-1. V23092-A1005-A802 реле 1 Form A.SPST-NO.1NO 5VDC/6A /TE/ цена от 80 шт	TE
4-1393236-2. V23092-A1060-A201 реле 1-Form-C.SPDT.1CO 60VDC/6A /TE/ цена от 200 шт	TE
4-1393236-3. V23092-A1060-A301 реле 1-Form-C.SPDT.1CO 60VDC/6A /TE/ цена от 100 шт	TE
6-1393236-8. V23092-B1005-A301 реле угл.1C 5B dc /TE/ цена от 800 шт	TE
7-1393236-1. V23092-B1012-A301 реле 1 Form C 12B 6A/250B /TE/ цена от 1000 шт	TE
V23092-12 /TE/ moq>5 price from 200 pcs	TE
V23092-12G /TE/ moq>5 price from 200 pcs	TE
V23092-A1005-A201 /TE/ moq>10	TE
V23092-A1005-A301 /TE/ moq>10	TE
V23092-A1012-A302 /SCHRACK - TE CONNECTIVITY/ moq> 250	SCHRACK - TE CONNECTIVITY
V23092-A1012-A302 /TE/ moq>10	TE
V23092-A1012-A302 /Tyco Electronics/TE Connectivity/ moq>10	Tyco Electronics/TE Connectivity
V23092-A1024-A201 /TE/ moq>10	TE
V23092-A1024-A201 /Tyco Electronics/TE Connectivity/ moq>2	Tyco Electronics/TE Connectivity
V23092-A1024-A202 /SCHRACK - TE CONNECTIVITY/ moq> 100	SCHRACK - TE CONNECTIVITY
V23092-A1048-A301 /SCHRACK - TE CONNECTIVITY/ moq> 150	SCHRACK - TE CONNECTIVITY
V23092-A1060-A301 /SCHRACK - TE CONNECTIVITY/ moq> 10	SCHRACK - TE CONNECTIVITY
V23092A1012A801 /SCHRACK - TE CONNECTIVITY/ moq> 250	SCHRACK - TE CONNECTIVITY
V23092B1024A301 /TE CONNECTIVITY/ moq> 25	TE
1393236-5, V23092-A1012-A202 реле	
1393236-7 (V23092A1012A301)	
1393236-7, V23092-A1012-A301 реле 1-Form-C, SPDT, 1CO 12VDC/6A моност.	
6-1393236-8, V23092-B1005-A301 реле угл.1C 5B dc	
7-1393236-1, V23092-B1012-A301 реле 1 Form C 12B 6A/250B	
V23092-A1005-A301	
V23092-A1012-A201	
V23092-A1024-A302	
V23092A1005A201	
V23092A1012A302	
V23092A1012A801	

V23092A1024A202	
V23092A1048A301	
V23092A1905A302	
V23092B1024A301	
V23092-A1024-A302 Реле	
РЕЛЕ SCHRACK V23092-A1012-A303 (12V)	
РЕЛЕ SIEMENS V23092-A1012-A302 (12V)	
РЕЛЕ SIEMENS V23092-A1048-A201 (48V)	
V23092-A1005-A202	TE Connectivity, Реле общего назначения
V23092-A1005-A301	TYCO, ультратонкое сменное реле 1393236-2, ,
V23092-A1005-A301	TE Connectivity / Schrack, Реле общего назначения
V23092-A1005-A301	TE Connectivity, PCB Relay SPDT 6A 5Vdc
V23092-A1005-A302	TYCO, ультратонкое сменное реле, ,
V23092-A1012-A201	TE Connectivity, PCB Relay SPDT 6A 12Vdc,g
V23092-A1012-A201	TE Connectivity / Schrack, Реле общего назначения
V23092-A1012-A301	SCHRACK - TE CONNECTIVITY, Универсальное реле, серия SNR, силовое, SPDT, 12B DC, 6A
V23092-A1012-A302	TE Connectivity / Schrack, Реле общего назначения PCB SPNO 12VDC
V23092-A1012-A302	SCHRACK - TE CONNECTIVITY, Универсальное реле, серия SNR, силовое, без защелки, SPST-NO, 12B DC, 6A
V23092-A1024-A201	SCHRACK - TE CONNECTIVITY, RELAY, SPDT, 24VDC, 6A, TH
V23092-A1024-A201	TE Connectivity / Schrack, Реле общего назначения RELAY SPDT 6A 24VDC
V23092-A1024-A202	SCHRACK - TE CONNECTIVITY, Реле питания, SPST-NO, 24 В DC, 6 А, SNR/V23092 Series, Сквозное Отверстие, Без Защелки
V23092-A1024-A301	SCHRACK - TE CONNECTIVITY, Универсальное реле, серия SNR, силовое, без защелки, SPDT, 24В DC, 6А
V23092-A1024-A302	SCHRACK - TE CONNECTIVITY, Универсальное реле, серия SNR, силовое, без защелки, SPST-NO, 24В DC, 6А
V23092-A1024-A302	TE Connectivity / Schrack, Реле общего назначения SPST-NO 1 N/O 24vdc
V23092-A1024-A801	TE Connectivity, PCB Relay SPDT 6A 24Vdc,s
V23092-A1024-A801	SCHRACK - TE CONNECTIVITY, Реле питания, SPDT, 24 В DC, 6 А, SNR/V23092 Series, Сквозное Отверстие, Без Защелки
V23092-A1048-A301	SCHRACK - TE CONNECTIVITY, PCB RELAY UP TO 10A
V23092-A1048-A301	TE Connectivity, Реле общего назначения
V23092-A1060-A301	SCHRACK - TE CONNECTIVITY, PCB RELAY UP TO 10A
V23092-A1905-A301	SCHRACK - TE CONNECTIVITY, Универсальное реле, серия SNR, без защелки, SPDT, 5В DC, 6А
V23092-A1905-A302	TE Connectivity, Универсальное реле, серия SNR, силовое, SPST-NO, 5В DC, 6А
V23092-B1024-A301	TE Connectivity, Реле общего назначения
V23092A1005A201	TE Connectivity, Relay,slim,PCB,SPDT,6A,5V
V23092A1005A201	TE Connectivity / Schrack, Реле общего назначения RELAY PWR SPDT
V23092A1012A301	TE Connectivity / Schrack, Реле общего назначения 12V 6A 1CO THT POWER RELAY
V23092A1012A302	TE Connectivity, V23092-A1012-A302, relay
V23092A1012A801	SCHRACK - TE CONNECTIVITY, Реле питания, SPDT, 12 В DC, 6 А, SNR/V23092 Series, Сквозное Отверстие, Без Защелки
V23092A1012A801	TE Connectivity, PCB Relay SPDT 6A 12Vdc,s
V23092A1024A202	TE Connectivity, Relay,slim,PCB,SPST-NO,6A
V23092A1024A301	TE Connectivity / Schrack, Реле общего назначения RELAY

	100
V23092A1048A201	TE Connectivity Potter & Brumfield Relays, RELAY GEN PURPOSE SPDT 6A 48V
V23092A1048A302	TE Connectivity Potter & Brumfield Relays, RELAY GEN PURPOSE SPST 6A 48V
V23092A1905A201	TE Connectivity Potter & Brumfield Relays, RELAY GEN PURP
V23092A1905A302	TE Connectivity, Relay, slim, PCB, SPDT, 6A, 5V
V23092B1024A301	TE Connectivity, Универсальное реле, серия SNR, силовое, без защелки, SPDT, 24В DC, 6А
V23092B1024A301	TE Connectivity, 5mm 6A SPDT pcb flat pack
V23092-A1005-A301	TE Connectivity, Реле электромеханическое
V23092-A1012-A301	TE Connectivity, Реле электромеханическое
V23092-A1012-A302	TE Connectivity, Реле электромеханическое
V23092-A1024-A201	TE Connectivity, Реле электромеханическое
V23092-A1024-A301	TE Connectivity, Реле электромеханическое
V23092-A1024-A302	TE Connectivity Potter & Brumfield Relays, RELAY GEN PURPOSE SPST 6A 24V
V23092-A1024-A801	TE Connectivity Potter & Brumfield Relays, RELAY GEN PURPOSE SPDT 6A 24V
V23092-A1024-A801	TE Connectivity, Реле электромеханическое
V23092-A1060-A301	TE Connectivity Potter & Brumfield Relays, RELAY GEN PURPOSE SPDT 6A 60V
V23092-B1024-A301	TE Connectivity Potter & Brumfield Relays, RELAY GEN PURPOSE SPDT 6A 24V
V23092A1005A201	TE Connectivity, Реле электромеханическое
V23092A1005A301	TE Connectivity Potter & Brumfield Relays, RELAY GENERAL PURPOSE SPDT 6A 5V
V23092A1012A202	TE Connectivity Potter & Brumfield Relays, RELAY GEN PURPOSE SPST 6A 12V
V23092A1012A302	TE Connectivity Potter & Brumfield Relays, RELAY GEN PURPOSE SPST 6A 12V
V23092A1012A801	TE Connectivity Potter & Brumfield Relays, RELAY GEN PURPOSE SPDT 6A 12V
V23092A1048A201	TE Connectivity Potter & Brumfield Relays, RELAY GEN PURPOSE SPDT 6A 48V
V23092A1048A301	TE Connectivity Potter & Brumfield Relays, RELAY GEN PURP
V23092A1048A302	TE Connectivity Potter & Brumfield Relays, RELAY GEN PURPOSE SPST 6A 48V
V23092A1905A201	TE Connectivity Potter & Brumfield Relays, RELAY GEN PURP
V23092A1905A301	TE Connectivity Potter & Brumfield Relays, RELAY GENERAL PURPOSE SPDT 6A 5V
V23092-A1005-A301	Te Connectivity
V23092-A1005-A801	Te Connectivity
V23092-A1012-A201	Te Connectivity
V23092-A1012-A301	Te Connectivity, RELAY, SPDT, 250VAC, 6A
V23092-A1012-A302	Te Connectivity, RELAY, PCB, SPNO, 12VDC; Series:V23092; Relay Type:General Purpose; Voltage, Coil DC Nom:12V; Resistance, Coil:848ohm; Poles, No. of:1; Configuration, Contact:SPNO; Voltage, Contact AC Max:250V; Voltage, Contact DC Max:300V; Current, Contact AC Max:6A; Mo
V23092-A1012-A802	Te Connectivity
V23092-A1024-A201	Te Connectivity, RELAY, SPDT, 250VAC, 6A
V23092-A1024-A302	Te Connectivity, RELAY, PCB, SPNO, 24VDC; Series:V23092; Relay Type:General Purpose; Voltage, Coil DC Nom:24V; Resistance, Coil:3.39kohm; Poles, No. of:1; Configuration, Contact:SPNO; Voltage, Contact AC Max:250V; Voltage, Contact DC Max:300V; Current, Contact AC Max:6A;
V23092-B1024-A201	Te Connectivity
V23092A1005A201	Te Connectivity
V23092A1012A302	Te Connectivity

V23092A1012A801	Te Connectivity, POWER RELAY, SPDT, 6A, 250VAC, TH
V23092A1024A202	Te Connectivity
V23092A1048A301	Te Connectivity
V23092A1905A301	Te Connectivity
V23092A1905A302	Te Connectivity, RELAY, SPST-NO, 250VAC, 6A
V23092B1024A301	Te Connectivity, RELAY, SPDT, 250VAC, 6A
V23092-A1012-A301	TE, R_SNR
V23092A1005A201	TE
V23092-A1005-A202	TE Connectivity, Реле общего назначения
V23092-A1005-A301	
V23092-A1005-A301	TE Connectivity / Schrack, Реле общего назначения V23092-A1005-A301
V23092-A1005-A301;1393236-2,реле 1-Form-C, SPDT, 1CO 5VDC 6A моностаб.	
V23092-A1005-A301;1393236-2,реле 1-Form-C, SPDT, 1CO 5VDC/6A моностаб.	
V23092-A1005-A801;1-1415068-1,реле 1-Form-C,SPST-CO,1NO 5VDC 6A	
V23092-A1005-A801;1-1415068-1,реле 1-Form-C,SPST-CO,1NO 5VDC/6A	
V23092-A1005-A802;1415068-1,реле 1-Form-A,SPST-NO,1NO 5VDC 6A	
V23092-A1005-A802;1415068-1,реле 1-Form-A,SPST-NO,1NO 5VDC/6A	
V23092-A1012-A201	TE Connectivity Potter & Brumfield Relays, RELAY GEN PURPOSE SPDT 6A 12V
V23092-A1012-A201	TE Connectivity / Schrack, Реле общего назначения
V23092-A1012-A201	
V23092-A1012-A201;0-1393236-4,реле 1-Form-C,SPDT,1CO 12VDC/6A	
V23092-A1012-A301	
V23092-A1012-A301	TE Connectivity Potter & Brumfield Relays, RELAY GEN PURPOSE SPDT 6A 12V
V23092-A1012-A301;1393236-7,реле 1-Form-C, SPDT, 1CO 12VDC 6A моност.	
V23092-A1012-A301;1393236-7,реле 1-Form-C, SPDT, 1CO 12VDC/6A моност.	
V23092-A1012-A302	
V23092-A1012-A302	TE Connectivity / Schrack, Реле общего назначения PCB SPNO 12VDC
V23092-A1024-A201	TE Connectivity / Schrack, Реле общего назначения RELAY SPDT 6A 24VDC
V23092-A1024-A201	
V23092-A1024-A201	TE Connectivity Potter & Brumfield Relays, RELAY GEN PURPOSE SPDT 6A 24V
V23092-A1024-A301	TE Connectivity Potter & Brumfield Relays, RELAY GEN PURPOSE SPDT 6A 24V
V23092-A1024-A301	
V23092-A1024-A301;2-1393236-4,реле 1-Form-C,SPDT,1CO 24VDC 6A	
V23092-A1024-A301;2-1393236-4,реле 1-Form-C,SPDT,1CO 24VDC/6A	
V23092-A1024-A302	TE Connectivity / Schrack, Реле общего назначения SPST-NO 1 N/O 24vdc
V23092-A1024-A302	
V23092-A1024-A302	TE Connectivity Potter & Brumfield Relays, RELAY GEN PURPOSE SPST 6A 24V
V23092-A1024-A302 Реле	
V23092-A1024-A302;2-1393236-5,реле 1-Form-A,SPST-NO,1NO 24VDC 6A	
V23092-A1024-A302;2-1393236-5,реле 1-Form-A,SPST-NO,1NO 24VDC/6A	
V23092-A1024-A801	TE Connectivity Potter & Brumfield Relays, RELAY GEN PURPOSE SPDT 6A 24V
V23092-A1048-A301	TE Connectivity, Реле общего назначения
V23092-A1060-A201;4-1393236-2,реле 1-Form-C,SPDT,1CO 60VDC 6A	

V23092-A1060-A201;4-1393236-2,реле 1-Form-C,SPDT,1CO 60VDC/6A	
V23092-A1060-A301	TE Connectivity Potter & Brumfield Relays, RELAY GEN PURPOSE SPDT 6A 60V
V23092-A1060-A301;4-1393236-3,реле 1-Form-C,SPDT,1CO 60VDC 6A	
V23092-A1060-A301;4-1393236-3,реле 1-Form-C,SPDT,1CO 60VDC/6A	
V23092-B1005-A301, 6-1393236-8 реле угл.1C 5B dc	
V23092-B1012-A301 7-1393236-1, реле 1 Form C 12B 6A 250B	
V23092-B1012-A301 7-1393236-1, реле 1 Form C 12B 6A/250B	
V23092-B1024-A301	TE Connectivity Potter & Brumfield Relays, RELAY GEN PURPOSE SPDT 6A 24V
V23092-B1024-A301	TE Connectivity, Реле общего назначения
V23092A1005A201	TE Connectivity / Schrack, Реле общего назначения RELAY PWR SPDT
V23092A1005A201	TE Connectivity Potter & Brumfield Relays, RELAY GENERAL PURPOSE SPDT 6A 5V
V23092A1005A201	
V23092A1005A301	TE Connectivity Potter & Brumfield Relays, RELAY GENERAL PURPOSE SPDT 6A 5V
V23092A1012A202	TE Connectivity Potter & Brumfield Relays, RELAY GEN PURPOSE SPST 6A 12V
V23092A1012A301	TE Connectivity / Schrack, Реле общего назначения 12V 6A 1CO THT POWER RELAY
V23092A1012A302	TE Connectivity Potter & Brumfield Relays, RELAY GEN PURPOSE SPST 6A 12V
V23092A1012A801	TE Connectivity Potter & Brumfield Relays, RELAY GEN PURPOSE SPDT 6A 12V
V23092A1024A201, 2-1393236-1 реле 1C; 24 В DC; 170 мВт	
V23092A1024A202	TE Connectivity Potter & Brumfield Relays, RELAY GEN PURPOSE SPST 6A 24V
V23092A1024A301	TE Connectivity / Schrack, Реле общего назначения RELAY 100
V23092A1048A201	TE Connectivity Potter & Brumfield Relays, RELAY GEN PURPOSE SPDT 6A 48V
V23092A1048A202	TE Connectivity Potter & Brumfield Relays, V23092-A1048-A202
V23092A1048A301	TE Connectivity Potter & Brumfield Relays, RELAY GEN PURP
V23092A1048A302	TE Connectivity Potter & Brumfield Relays, RELAY GEN PURPOSE SPST 6A 48V
V23092A1905A201	TE Connectivity Potter & Brumfield Relays, RELAY GEN PURP
V23092A1905A301	TE Connectivity Potter & Brumfield Relays, RELAY GENERAL PURPOSE SPDT 6A 5V
V23092A1905A302	TE Connectivity Potter & Brumfield Relays, RELAY GEN PURP
37-205-21 Relay 1-pole V23092 24VDC	ELFA
RELAY V23092-A1024A202	TE Connectivity
V23092-A1005-A201	TE Connectivity
V23092-A1005-A202	TE Connectivity
V23092-A1005-A301	TE Connectivity
V23092-A1005-A302	TE Connectivity
V23092-A1005-A801	TE Connectivity
V23092-A1005-A802	TE Connectivity
V23092-A1012-A201	TE Connectivity
V23092-A1012-A202	TE Connectivity
V23092-A1012-A301	TE Connectivity
V23092-A1012-A302	TE Connectivity
V23092-A1012-A303	TE Connectivity
V23092-A1012-A801	TE Connectivity
V23092-A1012-A802	TE Connectivity

V23092-A1018-A201	TE Connectivity
V23092-A1024-A201	TE Connectivity
V23092-A1024-A202	TE Connectivity
V23092-A1024-A301	SCHRACK
V23092-A1024-A301	TE Connectivity
V23092-A1024-A302	TE Connectivity
V23092-A1024-A801	TE Connectivity
V23092-A1024-A802	TE Connectivity
V23092-A1048-A201	TE Connectivity
V23092-A1060-A201	TE Connectivity
V23092-A1060-A301	TE Connectivity
V23092-A1060-A801	TE Connectivity
V23092-A1060-A802	TE Connectivity
V23092-A1905-A301	TE Connectivity
V23092-B1005-A201	TE Connectivity
V23092-B1005-A301	TE Connectivity
V23092-B1005-A801	TE Connectivity
V23092-B1012-A201	TE Connectivity
V23092-B1012-A301	TE Connectivity
V23092-B1012-A302	TE Connectivity
V23092-B1012-A801	TE Connectivity
V23092-B1024-A201	TE Connectivity
V23092-B1024-A301	TE Connectivity
V23092-B1905-A302	TE Connectivity
V23092-S1005-A301	TE Connectivity
V23092-S1024-A301	TE Connectivity
V23092A1005A201	TE Connectivity
V23092A1005A301	TE Connectivity
V23092A1012A201	TE Connectivity
V23092A1012A202	TE Connectivity
V23092A1012A301	TE Connectivity
V23092A1012A302	TE Connectivity
V23092A1012A801	TE Connectivity
V23092A1024A201	TE Connectivity
V23092A1024A202	TE Connectivity
V23092A1024A301	TE Connectivity
V23092A1024A302	TE Connectivity
V23092A1048A201	TE Connectivity
V23092A1048A202	TE Connectivity
V23092A1048A301	TE Connectivity
V23092A1048A302	TE Connectivity
V23092A1905A201	TE Connectivity
V23092A1905A301	TE Connectivity
V23092A1905A302	TE Connectivity
V23092B1024A301	TE Connectivity
V23092-A1024-A301	
SchrackV23092-A1012-A303(12V)	**РЕЛЕ,КОНТАКТОРЫ

SiemensV23092-A1012-A302(12V)	**РЕЛЕ,КОНТАКТОРЫ
SiemensV23092-A1048-A201(48V)	**РЕЛЕ,КОНТАКТОРЫ
V23092	MACOM [Tyco Electronics], Amp Slim Miniature, Board Rela
V23092-A1005-A201	MACOM [Tyco Electronics], Slim PCB Relay SN
V23092-A1005-A201 (0-1393236-1)	TE Connectivity (Tyco Electronics), Реле середньої потужності; Iк, А = 6; Uк, В = 400 АС; Uн, В = 5; Р, Вт = 0,17; Форма конт. = SPDT; Вид конт. групи = 1С; Ui/o, В = 1 000; Тексп, °С = -40...+85; Тип кер. U = DC; Тип монт. = РСВ; Час в
V23092-A1005-A202	MACOM [Tyco Electronics], Реле общего назначения
V23092-A1005-A301	MACOM [Tyco Electronics], Реле общего назначения V23092-A1005-A301
V23092-A1005-A301	
V23092-A1005-A301 (0-1393236-2)	TE Connectivity (Tyco Electronics), Реле середньої потужності; Iк, А = 6; Uк, В = 400 АС; Uн, В = 5; Р, Вт = 0,17; Форма конт. = SPDT; Вид конт. групи = 1С; Ui/o, В = 1 000; Тексп, °С = -40...+85; Тип кер. U = DC; Тип монт. = вивідний;
V23092-A1005-A302	MACOM [Tyco Electronics], Slim PCB Relay SN
V23092-A1005-A801	MACOM [Tyco Electronics], Slim PCB Relay SN
V23092-A1005-A802	MACOM [Tyco Electronics], Slim PCB Relay SN
V23092-A1012-A201	MACOM [Tyco Electronics], Реле общего назначения
V23092-A1012-A201	
V23092-A1012-A202	MACOM [Tyco Electronics], Slim PCB Relay SN
V23092-A1012-A203	Тысо (TE Connectivity)
V23092-A1012-A301	MACOM [Tyco Electronics], RELAY, SPDT, 250VAC, 6A; Contact Configuration:SPDT; Coil Voltage:12VDC; Contact Current:6A; Product Range:SNR Series; Relay Mounting:Through Hole; Coil Type:-; Contact Voltage VAC:250VAC; Relay Type:
V23092-A1012-A301 [1393236-7]	Тысо (TE Connectivity)
V23092-A1012-A302	MACOM [Tyco Electronics], Реле общего назначения PCB SPNO 12VDC
V23092-A1012-A303	Тысо (TE Connectivity)
V23092-A1012-A801	MACOM [Tyco Electronics], Slim PCB Relay SN
V23092-A1012-A802	MACOM [Tyco Electronics], Slim PCB Relay SN
V23092-A1024-A201	MACOM [Tyco Electronics], Реле общего назначения RELAY SPDT 6A 24VDC
V23092-A1024-A201	
V23092-A1024-A202	MACOM [Tyco Electronics], Slim PCB Relay SN
V23092-A1024-A203	Тысо (TE Connectivity)
V23092-A1024-A301	MACOM [Tyco Electronics], RELAY, SPDT, 250VAC, 6A; Contact Configuration:SPDT; Coil Voltage:24VDC; Contact Current:6A; Product Range:SNR Series; Relay Mounting:Through Hole; Coil Type:Non Latching; Contact Voltage VAC:250VAC;
V23092-A1024-A301 (2-1393236-4)	TE Connectivity (Tyco Electronics), Реле середньої потужності; Iк, А = 6; Uк, В = 400 АС; Uн, В = 24; Р, Вт = 0,17; Форма конт. = SPDT; Вид конт. групи = 1С; Ui/o, В = 1 000; Тексп, °С = -40...+85; Тип кер. U = DC; Тип монт. = РСВ; Ro,
V23092-A1024-A301 [2-1393236-4]	Тысо (TE Connectivity)
V23092-A1024-A302	MACOM [Tyco Electronics], Реле общего назначения SPST - NO 1 N/O 24vdc
V23092-A1024-A303	Тысо (TE Connectivity)
V23092-A1024-A801	MACOM [Tyco Electronics], Slimline PCB Relay SN
V23092-A1024-A802	MACOM [Tyco Electronics], Slimline PCB Relay SN
V23092-A1024A201	Тысо (TE Connectivity)
V23092-A1024A301	Тысо (TE Connectivity)
V23092-A1048-A201	MACOM [Tyco Electronics], Slimline PCB Relay SN
V23092-A1048-A202	MACOM [Tyco Electronics], Slimline PCB Relay SN

V23092-A1048-A301	MACOM [Tyco Electronics], Реле общего назначения
V23092-A1048-A302	MACOM [Tyco Electronics], Slimline PCB Relay SN
V23092-A1048-A801	MACOM [Tyco Electronics], Slimline PCB Relay SN
V23092-A1048-A802	MACOM [Tyco Electronics], Slimline PCB Relay SN
V23092-A1060-A301	POTTER&BRUMFIELD - TE CONNECTIVITY, V23092-A1060-A301
V23092-A1905-A301	MACOM [Tyco Electronics], General Purpose Relay, SNR Series, Non Latching, SPDT, 5 VDC, 6 A ;RoHS Compliant: Yes
V23092-A1905-A302	TE CONNECTIVITY, General Purpose Relay, SNR Series, Power, SPST-NO, 5 VDC, 6 A ;RoHS Compliant: Yes
V23092-B1005-A301	Tyco (TE Connectivity)
V23092-B1005-A3015V	
V23092-B1012-A201	Tyco (TE Connectivity)
V23092-B1012-A202	Tyco (TE Connectivity)
V23092-B1012-A301	TE CONNECTIVITY, V23092-B1012-A301
V23092-B1024-A201	POTTER&BRUMFIELD - TE CONNECTIVITY, V23092-B1024-A201
V23092-B1024-A202	Tyco (TE Connectivity)
V23092-B1024-A301	TE Connectivity, Реле общего назначения
V23092-B1024-A302	Tyco (TE Connectivity)
V23092-S1005-A201	MACOM [Tyco Electronics], Slimline PCB Relay SN
V23092-S1005-A301	MACOM [Tyco Electronics], Slimline PCB Relay SN
V23092-S1012-A201	MACOM [Tyco Electronics], Slimline PCB Relay SN
V23092-S1012-A301	MACOM [Tyco Electronics], Slimline PCB Relay SN
V23092-S1024-A201	MACOM [Tyco Electronics], Slimline PCB Relay SN
V23092-S1024-A301	MACOM [Tyco Electronics], Slimline PCB Relay SN
V23092-S1048-A201	MACOM [Tyco Electronics], Slimline PCB Relay SN
V23092-S1048-A301	MACOM [Tyco Electronics], Slimline PCB Relay SN
V23092-S1060-A201	MACOM [Tyco Electronics], Slimline PCB Relay SN
V23092-S1060-A301	MACOM [Tyco Electronics], Slimline PCB Relay SN
V23092A1005A201	ETC1 [List of Unclassified Manufacturers], Реле общего назначения RELAY PWR SPDT
V23092A1005A201 0-1393236-1	Tyco (TE Connectivity)
V23092A1005A202	ETC1 [List of Unclassified Manufacturers], Amp Slim Miniature, Board Rela
V23092A1005A301	ETC1 [List of Unclassified Manufacturers], Amp Slim Miniature, Board Rela
V23092A1005A301	
V23092A1005A302	ETC1 [List of Unclassified Manufacturers], Amp Slim Miniature, Board Rela
V23092A1006A201	ETC1 [List of Unclassified Manufacturers], Amp Slim Miniature, Board Rela
V23092A1006A202	ETC1 [List of Unclassified Manufacturers], Amp Slim Miniature, Board Rela
V23092A1006A301	ETC1 [List of Unclassified Manufacturers], Amp Slim Miniature, Board Rela
V23092A1006A302	ETC1 [List of Unclassified Manufacturers], Amp Slim Miniature, Board Rela
V23092A1012A201	ETC1 [List of Unclassified Manufacturers], Amp Slim Miniature, Board Rela
V23092A1012A202	ETC1 [List of Unclassified Manufacturers], Amp Slim Miniature, Board Rela
V23092A1012A301	ETC1 [List of Unclassified Manufacturers], Реле общего назначения 12V 6A 1CO THT POWER RELAY
V23092A1012A301	
V23092A1012A302	ETC1 [List of Unclassified Manufacturers], Amp Slim Miniature, Board Rela
V23092A1012A801	TE Connectivity Potter & Brumfield Relays, RELAY GEN PURPOSE SPDT 6A 12V

V23092A1024A201	ETC1 [List of Unclassified Manufacturers], Amp Slim Miniature, Board Rela
V23092A1024A202	ETC1 [List of Unclassified Manufacturers], Amp Slim Miniature, Board Rela
V23092A1024A301	ETC1 [List of Unclassified Manufacturers], Реле общего назначения RELAY 100
V23092A1024A302	ETC1 [List of Unclassified Manufacturers], Amp Slim Miniature, Board Rela
V23092A1048A201	Tyco Electronics
V23092A1048A202	Tyco Electronics
V23092A1048A301	Tyco Electronics
V23092A1048A302	Tyco Electronics
V23092A1048A801	Tyco (TE Connectivity)
V23092A148A201	ETC1 [List of Unclassified Manufacturers], Amp Slim Miniature, Board Rela
V23092A148A202	ETC1 [List of Unclassified Manufacturers], Amp Slim Miniature, Board Rela
V23092A148A301	ETC1 [List of Unclassified Manufacturers], Amp Slim Miniature, Board Rela
V23092A148A302	ETC1 [List of Unclassified Manufacturers], Amp Slim Miniature, Board Rela
V23092A1905A201	TE Connectivity Potter & Brumfield Relays, RELAY GEN PURP
V23092A1905A301	TE Connectivity
V23092A1905A302	TE Connectivity Potter & Brumfield Relays, RELAY GEN PURP
V23092B1005A201	Tyco (TE Connectivity)
V23092B1024A201	GLENAIR
V23092B1024A301	TE CONNECTIVITY, General Purpose Relay, SNR Series, Power, Non Latching, SPDT, 24 VDC, 6 A ;RoHS Compliant: Yes
V23092B1048A201	Tyco (TE Connectivity)
V23092B1048A301	Tyco (TE Connectivity)
V23092A1012A301	
V23092-A1005-A301	TE, Реле электромеханическое
V23092-A1012-A301	TE, Реле электромеханическое
V23092-A1024-A201	TE, Реле электромеханическое
V23092-A1024-A302	TE, Реле электромеханическое
V23092A1005A201	TE, Реле электромеханическое
РЕЛЕ SCHRACK V23092-A1012-A303 (12V)	
РЕЛЕ SIEMENS V23092-A1012-A302 (12V)	
РЕЛЕ SIEMENS V23092-A1048-A201 (48V)	
V23092-12	
V23092-12G	
V23092-24	
V23092-24G	
V23092-A1005-A301	TE
V23092-A1005-A301;1393236-2,реле 1-Form-C, SPDT, 1CO 5VDC/6A моностаб.	TYCO
V23092-A1005-A801;1-1415068-1,реле 1-Form-C,SPST-CO,1NO 5VDC/6A	TYCO
V23092-A1005-A802;1415068-1,реле 1-Form-A,SPST-NO,1NO 5VDC/6A	TYCO
V23092-A1012-A201	TE
V23092-A1012-A201;0-1393236-4,реле 1-Form-C,SPDT,1CO 12VDC/6A	TYCO
V23092-A1012-A301	TE
V23092-A1012-A301	SCHRACK
V23092-A1012-A301 [1393236-7]	TYCO
V23092-A1012-A301;1393236-7,реле 1-Form-C, SPDT, 1CO 12VDC/6A моност.	TYCO

V23092-A1012-A302	TE
V23092-A1024-A201	TE
V23092-A1024-A301	TE
V23092-A1024-A301 [2-1393236-4]	TYCO
V23092-A1024-A301;2-1393236-4,реле 1-Form-C,SPDT,1CO 24VDC/6A	TYCO
V23092-A1024-A302	TE
V23092-A1024-A302;2-1393236-5,реле 1-Form-A,SPST-NO,1NO 24VDC/6A	TYCO
V23092-A1060-A201;4-1393236-2,реле 1-Form-C,SPDT,1CO 60VDC/6A	TYCO
V23092-A1060-A301;4-1393236-3,реле 1-Form-C,SPDT,1CO 60VDC/6A	TYCO
V23092A1005A201	TE
Реле V23092-A1024-A301	
Реле V23092-A1024-A302	
V23092-12	
V23092-12G	
V23092-24	
V23092-24G	
V23092-A1012-A301	SCHRACK
V23092-A1012-A301 [1393236-7]	TYCO
V23092-A1024-A301 [2-1393236-4]	TYCO
1-1415068-1, V23092-A1005-A801 реле 1-Form-C,SPST-CO,1NO 5VDC/6A	TE Connectivity, реле электромагнитные
1393236-5, V23092-A1012-A202 реле	TE Connectivity, реле электромагнитные
1393236-7, V23092-A1012-A301реле 1-Form-C, SPDT, 1CO 12VDC/6A моност.	TE Connectivity, реле электромагнитные
1415068-1, V23092-A1005-A802 реле 1 Form A,SPST-NO,1NO 5VDC/6A	TE Connectivity, реле электромагнитные
2-1393236-1, V23092A1024A201 реле 1C; 24 В DC; 170 мВт	TE Connectivity, реле электромагнитные
4-1393236-3, V23092-A1060-A301 реле 1-Form-C,SPDT,1CO 60VDC/6A	TE Connectivity, реле электромагнитные
6-1393236-8, V23092-B1005-A301 реле угл.1C 5B dc	TE Connectivity, реле электромагнитные
7-1393236-1, V23092-B1012-A301 реле 1 Form C 12B 6A/250B	TE Connectivity, реле электромагнитные
V23092-A1005-A301	TE, Реле электромеханическое
V23092-A1012-A301	TE, Реле электромеханическое
V23092-A1024-A302	TE, Реле электромеханическое
V23092A1005A201	TE, Реле электромеханическое
V23092-A1012-A301	
V23092-A1024-A201	
V23092-A1024-A302	
V23092-A1905-A301	
V23092A1005A201	
V23092A1005A301	
V23092A1012A302	
V23092A1024A202	
V23092B1024A201	
V23092B1024A301	
2-1393236-5 (V23092-A1024-A302), Реле 1-Form-A,SPST-NO,1NO 24VDC/6A	TE Connectivity, Реле электромагнитные
V23092-A1005-A301	TE
V23092-A1005-A301;1393236-2,реле 1-Form-C, SPDT, 1CO 5VDC/6A моностаб.	TE Connectivity, реле электромагнитные
V23092-A1005-A801;1-1415068-1,реле 1-Form-C,SPST-CO,1NO 5VDC/6A	TE Connectivity, реле электромагнитные
V23092-A1005-A802;1415068-1,реле 1-Form-A,SPST-NO,1NO 5VDC/6A	TE Connectivity, реле электромагнитные

V23092-A1012-A201	TE
V23092-A1012-A301	TE
V23092-A1012-A301;1393236-7,реле 1-Form-C, SPDT, 1CO 12VDC/6A моностаб.	TE Connectivity, реле электромагнитные
V23092-A1012-A302	TE
V23092-A1024-A201	TE
V23092-A1024-A301;2-1393236-4,реле 1-Form-C,SPDT,1CO 24VDC/6A	TE Connectivity, реле электромагнитные
V23092-A1024-A302	TE
V23092-A1024-A302;2-1393236-5,реле 1-Form-A,SPST-NO,1NO 24VDC/6A	TE Connectivity, реле электромагнитные
V23092-A1060-A201;4-1393236-2,реле 1-Form-C,SPDT,1CO 60VDC/6A	TE Connectivity, реле электромагнитные
V23092-A1060-A301;4-1393236-3,реле 1-Form-C,SPDT,1CO 60VDC/6A	TE Connectivity, реле электромагнитные
V23092-B1005-A301, 6-1393236-8 реле угл.1C 5B dc	TE Connectivity, реле электромагнитные
V23092-B1012-A301 7-1393236-1, реле 1 Form C 12B 6A/250B	TE Connectivity, реле электромагнитные
V23092A1005A201	TE
V23092A1024A201, 2-1393236-1 реле 1C; 24 В DC; 170 мВт	TE Connectivity, реле электромагнитные
V23092A1005A201	Tyco Electronics/TE Connectivity
V23092A1005A301	Tyco Electronics/TE Connectivity
V23092A1012A201	Tyco Electronics/TE Connectivity
V23092A1012A301	Tyco Electronics/TE Connectivity
V23092A1012A302	Tyco Electronics/TE Connectivity
V23092A1024A201	Tyco Electronics/TE Connectivity
V23092A1024A301	Tyco Electronics/TE Connectivity
V23092A1024A302	Tyco Electronics/TE Connectivity
V23092A1048A301	Tyco Electronics/TE Connectivity
V23092A1905A301	Tyco Electronics/TE Connectivity
V23092A1905A302	Tyco Electronics/TE Connectivity
V23092B1024A301	Tyco Electronics/TE Connectivity
V23092-12	
V23092-12G	
V23092-24	
V23092-24G	
V23092-A1005-A301	TE
V23092-A1005-A301;1393236-2,реле 1-Form-C, SPDT, 1CO 5VDC/6A моностаб.	TYCO
V23092-A1005-A301;1393236-2,реле 1-Form-C, SPDT, 1CO 5VDC/6A моностаб.	TYCO, реле электромагнитные
V23092-A1005-A301;1393236-2,реле 1-Form-C, SPDT, 1CO 5VDC/6A моностаб.	TYCO, реле электромагнитные
V23092-A1005-A801;1-1415068-1,реле 1-Form-C,SPST-CO,1NO 5VDC/6A	TYCO
V23092-A1005-A801;1-1415068-1,реле 1-Form-C,SPST-CO,1NO 5VDC/6A	TYCO, реле электромагнитные
V23092-A1005-A801;1-1415068-1,реле 1-Form-C,SPST-CO,1NO 5VDC/6A	TYCO, реле электромагнитные
V23092-A1005-A802;1415068-1,реле 1-Form-A,SPST-NO,1NO 5VDC/6A	TYCO, реле электромагнитные
V23092-A1005-A802;1415068-1,реле 1-Form-A,SPST-NO,1NO 5VDC/6A	TYCO, реле электромагнитные
V23092-A1005-A802;1415068-1,реле 1-Form-A,SPST-NO,1NO 5VDC/6A	TYCO
V23092-A1012-A201	TE
V23092-A1012-A201;0-1393236-4,реле 1-Form-C,SPDT,1CO 12VDC/6A	TYCO
V23092-A1012-A201;0-1393236-4,реле 1-Form-C,SPDT,1CO 12VDC/6A	TYCO, реле электромагнитные
V23092-A1012-A201;0-1393236-4,реле 1-Form-C,SPDT,1CO 12VDC/6A	TYCO, реле электромагнитные
V23092-A1012-A301	TE
V23092-A1012-A301	SCHRACK, DIP

V23092-A1012-A301	SCHRACK
V23092-A1012-A301 [1393236-7]	TYCO
V23092-A1012-A301;1393236-7,реле 1-Form-C, SPDT, 1CO 12VDC/6A моност.	TYCO
V23092-A1012-A301;1393236-7,реле 1-Form-C, SPDT, 1CO 12VDC/6A моност.	TYCO, реле электромагнитные
V23092-A1012-A301;1393236-7,реле 1-Form-C, SPDT, 1CO 12VDC/6A моност.	TYCO, реле электромагнитные
V23092-A1012-A302	TE
V23092-A1024-A201	TE
V23092-A1024-A301	TE
V23092-A1024-A301 [2-1393236-4]	TYCO
V23092-A1024-A301;2-1393236-4,реле 1-Form-C,SPDT,1CO 24VDC/6A	TYCO, реле электромагнитные
V23092-A1024-A301;2-1393236-4,реле 1-Form-C,SPDT,1CO 24VDC/6A	TYCO, реле электромагнитные
V23092-A1024-A301;2-1393236-4,реле 1-Form-C,SPDT,1CO 24VDC/6A	TYCO
V23092-A1024-A302	TE
V23092-A1024-A302;2-1393236-5,реле 1-Form-A,SPST-NO,1NO 24VDC/6A	TYCO
V23092-A1024-A302;2-1393236-5,реле 1-Form-A,SPST-NO,1NO 24VDC/6A	TYCO, реле электромагнитные
V23092-A1024-A302;2-1393236-5,реле 1-Form-A,SPST-NO,1NO 24VDC/6A	TYCO, реле электромагнитные
V23092-A1060-A201;4-1393236-2,реле 1-Form-C,SPDT,1CO 60VDC/6A	TYCO
V23092-A1060-A201;4-1393236-2,реле 1-Form-C,SPDT,1CO 60VDC/6A	TYCO, реле электромагнитные
V23092-A1060-A201;4-1393236-2,реле 1-Form-C,SPDT,1CO 60VDC/6A	TYCO, реле электромагнитные
V23092-A1060-A301;4-1393236-3,реле 1-Form-C,SPDT,1CO 60VDC/6A	TYCO, реле электромагнитные
V23092-A1060-A301;4-1393236-3,реле 1-Form-C,SPDT,1CO 60VDC/6A	TYCO, реле электромагнитные
V23092-A1060-A301;4-1393236-3,реле 1-Form-C,SPDT,1CO 60VDC/6A	TYCO
V23092A1005A201	TE
Реле V23092-A1024-A301	
Реле V23092-A1024-A302	
V23092-A1005-A301	
V23092-A1012-A301	
V23092-A1012-A302	
V23092-A1024-A201	
V23092-A1024-A301	
V23092-A1024-A302	
V23092A1005A201	
Реле-V23092-A1024-A201	
1-1415068-1, V23092-A1005-A801 реле 1-Form-C,SPST-CO,1NO 5VDC/6A	
1393236-2, V23092-A1005-A301 реле 1-Form-C, SPDT, 1CO 5VDC/6A моностаб.	
1393236-5, V23092-A1012-A202 реле	
1393236-7, V23092-A1012-A301реле 1-Form-C, SPDT, 1CO 12VDC/6A моност.	
1415068-1, V23092-A1005-A802 реле 1 Form A,SPST-NO,1NO 5VDC/6A	
2-1393236-1, V23092A1024A201 реле 1C; 24 В DC; 170 мВт	
4-1393236-2, V23092-A1060-A201 реле 1-Form-C,SPDT,1CO 60VDC/6A	
6-1393236-8, V23092-B1005-A301 реле угл.1C 5B dc	
7-1393236-1, V23092-B1012-A301 реле 1 Form C 12B 6A/250B	
V23092-A1005-A301	
V23092-A1012-A301	
V23092-A1012-A302	
V23092-A1024-A201	

V23092-A1024-A302	
V23092A1005A201	
V23092A1024A301, реле	
5-1415063-1 V23092-A1024-A802 AGNI90/10	Tyco Electronics
V23092-A1005-A301	Tyco Electronics, Electromechanical Relay 5VDC 1470hm 10A SPDT (28x5x15)mm THT Slim PCB Relay
V23092-A1005-A302	Tyco Electronics
V23092-A1005-A801	Tyco Electronics
V23092-A1012-A201	Tyco Electronics, Electromechanical Relay 12VDC 8480hm 10A SPDT (28x5x15)mm THT Slim PCB Relay
V23092-A1012-A301	Tyco Electronics, Electromechanical Relay 12VDC 8480hm 10A SPDT(28x5x15)mm THT Slim PCB Relay RELAY, SPDT, 250VAC, 6A
V23092-A1012-A302	Tyco Electronics, Electromechanical Relay 12VDC 8480hm 10A SPST-NO(28x5x15)mm THT Slim PCB Relay RELAY, SPST-NO, 250VAC, 6A Реле пост...
V23092-A1012-A802	Tyco Electronics
V23092-A1024-A201	Tyco Electronics, Electromechanical Relay 24VDC 3.39KOhm 10A SPDT(28x5x15)mm THT Slim PCB Relay RELAY, SPDT, 24VDC, 6A, TH
V23092-A1024-A202	Tyco Electronics, POWER RELAY, SPST-NO, 6A, 250VAC, TH
V23092-A1024-A302	Tyco Electronics, Electromechanical Relay 24VDC 3.39KOhm 10A SPST-NO ((28mm 5mm 15mm)) THT Slim PCB Relay RELAY, SPST-NO, 250VAC, 6A
V23092-A1024-A801	Tyco Electronics, Electromechanical Relay 24VDC 3.39KOhm 10A SPDT ((28mm 5mm 15mm)) THT Slim PCB Relay POWER RELAY, SPDT, 6A, 250VAC, TH
V23092-A1060-A301	Tyco Electronics
V23092-A1905-A301	Tyco Electronics, Electromechanical Relay 5VDC 1190hm 6A SPDT (28x5x15)mm THT Industrial Relay RELAY, SPDT, 250VAC, 6A Реле постоянно...
V23092-A1905-A302	Tyco Electronics, RELAY, SPST-NO, 250VAC, 6A
V23092-B1024-A201	Tyco Electronics
V23092-B1905-A302	Tyco Electronics
V23092-S1060-A301	Tyco Electronics
V23092A1005A201	Tyco Electronics
V23092A1012A801	Tyco Electronics, Electromechanical Relay 12VDC 8480hm 10A SPDT (28x5x15)mm THT Slim PCB Relay POWER RELAY, SPDT, 6A, 250VAC, TH
V23092A1048A302	Tyco Electronics, Electromechanical Relay 48VDC 10.6KOhm 6A SPST-NO (28x5x15)mm THT PCB Relay. Мин.заказ=1000
V23092B1024A301	Tyco Electronics, Electromechanical Relay 24VDC 3.39KOhm 10A SPDT (28x15.5x5)mm THT Slim PCB Relay RELAY, SPDT, 250VAC, 6A
V23092	ETC1 [List of Unclassified Manufacturers], 6 Amp Slim Miniature, PC Board Relay
V23092-A1005-A201	MACOM [Tyco Electronics], Slim PCB Relay SNR
V23092-A1005-A201 (0-1393236-1)	TE Connectivity (Tyco Electronics), Реле середньої потужності; Ік, А = 6; Ук, В = 400 АС; Ун, В = 5; Р, Вт = 0,17; Форма конт. = SPDT; Вид конт. групи = 1С; Ui/o, В = 1 000; Тексп, °С = -40...+85; Тип кер. U = DC; Тип монт. = PCB; Час в
V23092-A1005-A202	MACOM [Tyco Electronics], Slim PCB Relay SNR
V23092-A1005-A301	
V23092-A1005-A301	Tyco Electronics, RELAY INDUSTRIAL Серия: SNR, SCHRACK · Тип реле: General Purpose · Каналы: SPDT (1 Form C) · Ток @ напряжение: 6A @ 240VAC · Тип катушки: Стандарт · Ток соленоида: 34mA · Напряжение соленоида: 5VDC · Контроль входного напряжения (макс): 3.5 VDC · Контроль
V23092-A1005-A301 (0-1393236-2)	TE Connectivity (Tyco Electronics), Реле середньої потужності; Ік, А = 6; Ук, В = 400 АС; Ун, В = 5; Р, Вт = 0,17; Форма конт. = SPDT; Вид конт. групи = 1С; Ui/o, В = 1 000; Тексп, °С = -40...+85; Тип кер. U = DC; Тип монт. = вивідний;
V23092-A1005-A302	MACOM [Tyco Electronics], Slim PCB Relay SNR
V23092-A1005-A801	MACOM [Tyco Electronics], Slim PCB Relay SNR

V23092-A1005-A802	MACOM [Tyco Electronics], Slim PCB Relay SNR
V23092-A1012-A201	Tyco Electronics, RELAY INDUSTRIAL Серия: SNR, SCHRACK · Тип реле: General Purpose · Каналы: SPDT (1 Form C) · Ток @ напряжение: 6A @ 240VAC · Тип катушки: Стандарт · Ток соленоида: 14.2mA · Напряжение соленоида: 12VDC · Контроль входного напряжения (макс): 8.4 VDC · Контр
V23092-A1012-A201	
V23092-A1012-A202	MACOM [Tyco Electronics], Slim PCB Relay SNR
V23092-A1012-A203	Tyco (TE Connectivity)
V23092-A1012-A301	Tyco Electronics, RELAY SLIM SPDT 6A 12VDC PCB Серия: SNR, SCHRACK · Тип реле: General Purpose · Каналы: SPDT (1 Form C) · Ток @ напряжение: 6A @ 240VAC · Тип катушки: Стандарт · Ток соленоида: 14.2mA · Напряжение соленоида: 12VDC · Контроль входного напряжения (макс): 8.4
V23092-A1012-A301 [1393236-7]	Tyco (TE Connectivity)
V23092-A1012-A302	MACOM [Tyco Electronics], Slim PCB Relay SNR
V23092-A1012-A303	Tyco (TE Connectivity)
V23092-A1012-A801	MACOM [Tyco Electronics], Slim PCB Relay SNR
V23092-A1012-A802	MACOM [Tyco Electronics], Slim PCB Relay SNR
V23092-A1024-A201	Tyco Electronics, RELAY PWR SPDT 6A 24VDC PCB Серия: SNR, SCHRACK · Тип реле: General Purpose · Каналы: SPDT (1 Form C) · Ток @ напряжение: 6A @ 240VAC · Тип катушки: Стандарт · Ток соленоида: 7mA · Напряжение соленоида: 24VDC · Контроль входного напряжения (макс): 16.8 VD
V23092-A1024-A201	
V23092-A1024-A202	MACOM [Tyco Electronics], Slim PCB Relay SNR
V23092-A1024-A203	Tyco (TE Connectivity)
V23092-A1024-A301	MACOM [Tyco Electronics], Slim PCB Relay SNR
V23092-A1024-A301 (2-1393236-4)	TE Connectivity (Tyco Electronics), Реле середньої потужності; Ік, А = 6; Ук, В = 400 АС; Ун, В = 24; Р, Вт = 0,17; Форма конт. = SPDT; Вид конт. групи = 1С; U _{i/o} , В = 1 000; Тексп, °С = -40...+85; Тип кер. U = DC; Тип монт. = PCB; Ro,
V23092-A1024-A301 [2-1393236-4]	Tyco (TE Connectivity)
V23092-A1024-A302	Tyco Electronics, RELAY SLIM SPST-NO 6A 24VDC PCB Серия: SNR, SCHRACK · Тип реле: General Purpose · Каналы: SPST-NO (1 Form A) · Ток @ напряжение: 6A @ 240VAC · Тип катушки: Стандарт · Ток соленоида: 7mA · Напряжение соленоида: 24VDC · Контроль входного напряжения (макс):
V23092-A1024-A303	Tyco (TE Connectivity)
V23092-A1024-A801	MACOM [Tyco Electronics], Slimline PCB Relay SNR
V23092-A1024-A802	MACOM [Tyco Electronics], Slimline PCB Relay SNR
V23092-A1024A201	Tyco (TE Connectivity)
V23092-A1024A301	Tyco (TE Connectivity)
V23092-A1048-A201	MACOM [Tyco Electronics], Slimline PCB Relay SNR
V23092-A1048-A202	MACOM [Tyco Electronics], Slimline PCB Relay SNR
V23092-A1048-A301	MACOM [Tyco Electronics], Slimline PCB Relay SNR
V23092-A1048-A302	MACOM [Tyco Electronics], Slimline PCB Relay SNR
V23092-A1048-A801	MACOM [Tyco Electronics], Slimline PCB Relay SNR
V23092-A1048-A802	MACOM [Tyco Electronics], Slimline PCB Relay SNR
V23092-A1060-A301	Tyco (TE Connectivity)
V23092-A1905-A301	GLENAIR
V23092-A1905-A302	TE CONNECTIVITY, RELAY, PCB, SPNO, 5VDC; Product Range:TE - SNR Series; Coil Voltage:5VDC; Contact Current:6A; Contact Voltage VAC:250V; Contact Voltage VDC:-; Contact Configuration:1NO; Coil Resistance:148ohm; Relay
V23092-B1005-A301	Tyco (TE Connectivity)
V23092-B1005-A3015V	

V23092-B1012-A201	Tyco (TE Connectivity)
V23092-B1012-A202	Tyco (TE Connectivity)
V23092-B1012-A301	Tyco (TE Connectivity)
V23092-B1024-A201	Tyco (TE Connectivity)
V23092-B1024-A202	Tyco (TE Connectivity)
V23092-B1024-A301	Tyco Electronics, RELAY INDUSTRIAL Серия: SNR, SCHRACK · Тип реле: General Purpose · Каналы: SPDT (1 Form C) · Ток @ напряжение: 6A @ 240VAC · Тип катушки: Стандарт · Ток соленоида: 7mA · Напряжение соленоида: 24VDC · Контроль входного напряжения (макс): 16.8 VDC · Контроль
V23092-B1024-A302	Tyco (TE Connectivity)
V23092-S1005-A201	MACOM [Tyco Electronics], Slimline PCB Relay SNR
V23092-S1005-A301	MACOM [Tyco Electronics], Slimline PCB Relay SNR
V23092-S1012-A201	MACOM [Tyco Electronics], Slimline PCB Relay SNR
V23092-S1012-A301	MACOM [Tyco Electronics], Slimline PCB Relay SNR
V23092-S1024-A201	MACOM [Tyco Electronics], Slimline PCB Relay SNR
V23092-S1024-A301	MACOM [Tyco Electronics], Slimline PCB Relay SNR
V23092-S1048-A201	MACOM [Tyco Electronics], Slimline PCB Relay SNR
V23092-S1048-A301	MACOM [Tyco Electronics], Slimline PCB Relay SNR
V23092-S1060-A201	MACOM [Tyco Electronics], Slimline PCB Relay SNR
V23092-S1060-A301	MACOM [Tyco Electronics], Slimline PCB Relay SNR
V23092A1005A201	Tyco Electronics, RELAY PWR SPDT 6A 5VDC PCB Серия: SNR, SCHRACK · Тип реле: General Purpose · Каналы: SPDT (1 Form C) · Ток @ напряжение: 6A @ 240VAC · Тип катушки: Стандарт · Ток соленоида: 34mA · Напряжение соленоида: 5VDC · Контроль входного напряжения (макс): 3.5 VDC
V23092A1005A201 0-1393236-1	Tyco (TE Connectivity)
V23092A1005A201-ND	TE Connectivity, RELAY GENERAL PURPOSE SPDT 6A 5V
V23092A1005A202	ETC1 [List of Unclassified Manufacturers], 6 Amp Slim Miniature, PC Board Relay
V23092A1005A301	TE Connectivity, ElectromechanicalRelaySPDT10A5VDC147OhmThroughHole
V23092A1005A301	
V23092A1005A302	ETC1 [List of Unclassified Manufacturers], 6 Amp Slim Miniature, PC Board Relay
V23092A1006A201	ETC1 [List of Unclassified Manufacturers], 6 Amp Slim Miniature, PC Board Relay
V23092A1006A202	ETC1 [List of Unclassified Manufacturers], 6 Amp Slim Miniature, PC Board Relay
V23092A1006A301	ETC1 [List of Unclassified Manufacturers], 6 Amp Slim Miniature, PC Board Relay
V23092A1006A302	ETC1 [List of Unclassified Manufacturers], 6 Amp Slim Miniature, PC Board Relay
V23092A1012A201	ETC1 [List of Unclassified Manufacturers], 6 Amp Slim Miniature, PC Board Relay
V23092A1012A201-ND	TE Connectivity, RELAY GEN PURPOSE SPDT 6A 12V
V23092A1012A202	ETC1 [List of Unclassified Manufacturers], 6 Amp Slim Miniature, PC Board Relay
V23092A1012A202-ND	TE Connectivity, RELAY GEN PURPOSE SPST 6A 12V
V23092A1012A301	ETC1 [List of Unclassified Manufacturers], 6 Amp Slim Miniature, PC Board Relay
V23092A1012A301	
V23092A1012A302	GLENAIR
V23092A1012A302-ND	TE Connectivity, RELAY GEN PURPOSE SPST 6A 12V
V23092A1012A801	Tyco (TE Connectivity)
V23092A1024A201	ETC1 [List of Unclassified Manufacturers], 6 Amp Slim Miniature, PC Board Relay
V23092A1024A202	TE Connectivity, ElectromechanicalRelaySPST-NO10A24VDC3.39KOhmThroughH
V23092A1024A202-ND	TE Connectivity, RELAY GEN PURPOSE SPST 6A 24V

V23092A1024A301	ETC1 [List of Unclassified Manufacturers], 6 Amp Slim Miniature, PC Board Relay
V23092A1024A301-ND	TE Connectivity, RELAY GEN PURPOSE SPDT 6A 24V
V23092A1024A302	ETC1 [List of Unclassified Manufacturers], 6 Amp Slim Miniature, PC Board Relay
V23092A1048A201	Tyco (TE Connectivity)
V23092A1048A201-ND	TE Connectivity, RELAY GEN PURPOSE SPDT 6A 48V
V23092A1048A202	Tyco (TE Connectivity)
V23092A1048A301	Tyco (TE Connectivity)
V23092A1048A301-ND	TE Connectivity, RELAY GEN PURP
V23092A1048A302	Tyco (TE Connectivity)
V23092A1048A302-ND	TE Connectivity, RELAY GEN PURPOSE SPST 6A 48V
V23092A1048A801	Tyco (TE Connectivity)
V23092A148A201	ETC1 [List of Unclassified Manufacturers], 6 Amp Slim Miniature, PC Board Relay
V23092A148A202	ETC1 [List of Unclassified Manufacturers], 6 Amp Slim Miniature, PC Board Relay
V23092A148A301	ETC1 [List of Unclassified Manufacturers], 6 Amp Slim Miniature, PC Board Relay
V23092A148A302	ETC1 [List of Unclassified Manufacturers], 6 Amp Slim Miniature, PC Board Relay
V23092A1905A201	TE Connectivity, RELAY GEN PURP
V23092A1905A201-ND	TE Connectivity, RELAY GEN PURP
V23092A1905A301	Tyco (TE Connectivity)
V23092A1905A301-ND	TE Connectivity, RELAY GENERAL PURPOSE SPDT 6A 5V
V23092A1905A302	Tyco (TE Connectivity)
V23092A1905A302-ND	TE Connectivity, RELAY GEN PURP
V23092B1005A201	Tyco (TE Connectivity)
V23092B1024A201	GLENAIR
V23092B1024A301	TE Connectivity, Electromechanical Relay SPDT10A24VDC3.39KOhmThroughHole
V23092B1048A201	Tyco (TE Connectivity)
V23092B1048A301	Tyco (TE Connectivity)
V23092	ETC1 [List of Unclassified Manufacturers], Amp Slim Miniature, Board Rela
V23092-A1005-A201	MACOM [Tyco Electronics]
V23092-A1005-A201 (0-1393236-1)	TE Connectivity (Tyco Electronics), Реле середньої потужності; Iк, А = 6; Uк, В = 400 АС; Uн, В = 5; Р, Вт = 0,17; Форма конт. = SPDT; Вид конт. групи = 1С; Uі/о, В = 1 000; Тексп, °С = -40...+85; Тип кер. U = DC; Тип монт. = РСВ; Час в
V23092-A1005-A202	MACOM [Tyco Electronics], Реле общего назначения
V23092-A1005-A301	
V23092-A1005-A301	MACOM [Tyco Electronics], Реле общего назначения
V23092-A1005-A301 (0-1393236-2)	TE Connectivity (Tyco Electronics), Реле середньої потужності; Iк, А = 6; Uк, В = 400 АС; Uн, В = 5; Р, Вт = 0,17; Форма конт. = SPDT; Вид конт. групи = 1С; Uі/о, В = 1 000; Тексп, °С = -40...+85; Тип кер. U = DC; Тип монт. = вивідний;
V23092-A1005-A302	MACOM [Tyco Electronics]
V23092-A1005-A801	MACOM [Tyco Electronics]
V23092-A1005-A802	MACOM [Tyco Electronics]
V23092-A1012-A201	MACOM [Tyco Electronics], Реле общего назначения
V23092-A1012-A201	
V23092-A1012-A202	MACOM [Tyco Electronics], Slim PCB Relay SN
V23092-A1012-A203	Tyco (TE Connectivity)
V23092-A1012-A301	MACOM [Tyco Electronics]
V23092-A1012-A301 [1393236-7]	Tyco (TE Connectivity)

V23092-A1012-A302	MACOM [Tyco Electronics], Реле общего назначения PCB SPNO 12VDC
V23092-A1012-A303	Тысо (TE Connectivity)
V23092-A1012-A801	MACOM [Tyco Electronics], Slim PCB Relay SN
V23092-A1012-A802	MACOM [Tyco Electronics]
V23092-A1024-A201	MACOM [Tyco Electronics], Реле общего назначения RELAY SPDT 6A 24VDC
V23092-A1024-A201	
V23092-A1024-A202	MACOM [Tyco Electronics], Slim PCB Relay SN
V23092-A1024-A203	Тысо (TE Connectivity)
V23092-A1024-A301	MACOM [Tyco Electronics]
V23092-A1024-A301 (2-1393236-4)	TE Connectivity (Tyco Electronics), Реле средней мощности; Iк, А = 6; Uк, В = 400 АС; Uн, В = 24; Р, Вт = 0,17; Форма конт. = SPDT; Вид конт. группы = 1С; Uи/о, В = 1 000; Тексп, °С = -40...+85; Тип кер. U = DC; Тип монт. = PCB; Ro,
V23092-A1024-A301 [2-1393236-4]	Тысо (TE Connectivity)
V23092-A1024-A302	MACOM [Tyco Electronics], Реле общего назначения SPST-NO 1 N/O 24vdc
V23092-A1024-A303	Тысо (TE Connectivity)
V23092-A1024-A801	MACOM [Tyco Electronics]
V23092-A1024-A802	MACOM [Tyco Electronics]
V23092-A1024A201	Тысо (TE Connectivity)
V23092-A1024A301	Тысо (TE Connectivity)
V23092-A1048-A201	MACOM [Tyco Electronics], Slimline PCB Relay SN
V23092-A1048-A202	MACOM [Tyco Electronics], Slimline PCB Relay SN
V23092-A1048-A301	MACOM [Tyco Electronics], Реле общего назначения
V23092-A1048-A302	MACOM [Tyco Electronics], Slimline PCB Relay SN
V23092-A1048-A801	MACOM [Tyco Electronics], Slimline PCB Relay SN
V23092-A1048-A802	MACOM [Tyco Electronics]
V23092-A1060-A301	Тысо (TE Connectivity)
V23092-A1905-A301	MACOM [Tyco Electronics]
V23092-A1905-A302	TE CONNECTIVITY, RELAY, PCB, SPNO, 5VDC; Product Range:TE - SNR Series; Coil Voltage:5VDC; Contact Current:6A; Contact Voltage VAC:250V; Contact Voltage VDC:-; Contact Configuration:1NO; Coil Resistance:148ohm; Relay
V23092-B1005-A301	Тысо (TE Connectivity)
V23092-B1005-A3015V	
V23092-B1012-A201	Тысо (TE Connectivity)
V23092-B1012-A202	Тысо (TE Connectivity)
V23092-B1012-A301	Тысо (TE Connectivity)
V23092-B1024-A201	Тысо (TE Connectivity)
V23092-B1024-A202	Тысо (TE Connectivity)
V23092-B1024-A301	Тысо (TE Connectivity), Реле общего назначения
V23092-B1024-A302	Тысо (TE Connectivity)
V23092-S1005-A201	MACOM [Tyco Electronics], Slimline PCB Relay SN
V23092-S1005-A301	MACOM [Tyco Electronics], Slimline PCB Relay SN
V23092-S1012-A201	MACOM [Tyco Electronics], Slimline PCB Relay SN
V23092-S1012-A301	MACOM [Tyco Electronics], Slimline PCB Relay SN
V23092-S1024-A201	MACOM [Tyco Electronics], Slimline PCB Relay SN
V23092-S1024-A301	MACOM [Tyco Electronics], Slimline PCB Relay SN
V23092-S1048-A201	MACOM [Tyco Electronics], Slimline PCB Relay SN
V23092-S1048-A301	MACOM [Tyco Electronics], Slimline PCB Relay SN

V23092-S1060-A201	MACOM [Tyco Electronics], Slimline PCB Relay SN
V23092-S1060-A301	MACOM [Tyco Electronics], Slimline PCB Relay SN
V23092A1005A201	ETC1 [List of Unclassified Manufacturers], Реле общего назначения RELAY PWR SPDT
V23092A1005A201 0-1393236-1	Тыко (TE Connectivity)
V23092A1005A201-ND	TE Connectivity, RELAY GENERAL PURPOSE SPDT 6A 5V
V23092A1005A202	ETC1 [List of Unclassified Manufacturers], Amp Slim Miniature, Board Rela
V23092A1005A301	ETC1 [List of Unclassified Manufacturers]
V23092A1005A301	
V23092A1005A302	ETC1 [List of Unclassified Manufacturers], Amp Slim Miniature, Board Rela
V23092A1006A201	ETC1 [List of Unclassified Manufacturers], Amp Slim Miniature, Board Rela
V23092A1006A202	ETC1 [List of Unclassified Manufacturers], Amp Slim Miniature, Board Rela
V23092A1006A301	ETC1 [List of Unclassified Manufacturers], Amp Slim Miniature, Board Rela
V23092A1006A302	ETC1 [List of Unclassified Manufacturers], Amp Slim Miniature, Board Rela
V23092A1012A201	ETC1 [List of Unclassified Manufacturers]
V23092A1012A201-ND	TE Connectivity, RELAY GEN PURPOSE SPDT 6A 12V
V23092A1012A202	ETC1 [List of Unclassified Manufacturers]
V23092A1012A202-ND	TE Connectivity, RELAY GEN PURPOSE SPST 6A 12V
V23092A1012A301	ETC1 [List of Unclassified Manufacturers], Реле общего назначения 12V 6A 1CO THT POWER RELAY
V23092A1012A301	
V23092A1012A302	ETC1 [List of Unclassified Manufacturers]
V23092A1012A302-ND	TE Connectivity, RELAY GEN PURPOSE SPST 6A 12V
V23092A1012A801	Тыко (TE Connectivity)
V23092A1024A201	ETC1 [List of Unclassified Manufacturers]
V23092A1024A202	ETC1 [List of Unclassified Manufacturers]
V23092A1024A202-ND	TE Connectivity, RELAY GEN PURPOSE SPST 6A 24V
V23092A1024A301	ETC1 [List of Unclassified Manufacturers], Реле общего назначения RELAY 100
V23092A1024A301-ND	TE Connectivity, RELAY GEN PURPOSE SPDT 6A 24V
V23092A1024A302	ETC1 [List of Unclassified Manufacturers]
V23092A1048A201	Тыко (TE Connectivity)
V23092A1048A201-ND	TE Connectivity, RELAY GEN PURPOSE SPDT 6A 48V
V23092A1048A202	Тыко (TE Connectivity)
V23092A1048A301	Тыко (TE Connectivity)
V23092A1048A301-ND	TE Connectivity, RELAY GEN PURP
V23092A1048A302	Тыко (TE Connectivity)
V23092A1048A302-ND	TE Connectivity, RELAY GEN PURPOSE SPST 6A 48V
V23092A1048A801	Тыко (TE Connectivity)
V23092A148A201	ETC1 [List of Unclassified Manufacturers], Amp Slim Miniature, Board Rela
V23092A148A202	ETC1 [List of Unclassified Manufacturers], Amp Slim Miniature, Board Rela
V23092A148A301	ETC1 [List of Unclassified Manufacturers], Amp Slim Miniature, Board Rela
V23092A148A302	ETC1 [List of Unclassified Manufacturers], Amp Slim Miniature, Board Rela
V23092A1905A201	TE Connectivity, RELAY GEN PURP
V23092A1905A201-ND	TE Connectivity, RELAY GEN PURP
V23092A1905A301	Тыко (TE Connectivity)

V23092A1905A301-ND	TE Connectivity, RELAY GENERAL PURPOSE SPDT 6A 5V
V23092A1905A302	Tyco (TE Connectivity)
V23092A1905A302-ND	TE Connectivity, RELAY GEN PURP
V23092B1005A201	Tyco (TE Connectivity)
V23092B1024A201	GLENAIR
V23092B1024A301	TE CONNECTIVITY, RELAY, PCB, SPCO, 24VDC; Product Range:TE - SNR Series; Coil Voltage:24VDC; Contact Current:6A; Contact Voltage VAC:250V; Contact Voltage VDC:-; Contact Configuration:SPCO; Coil Resistance:3.39kohm; R
V23092B1048A201	Tyco (TE Connectivity)
V23092B1048A301	Tyco (TE Connectivity)

г.Минск www.fotorele.net www.tiristor.by email minsk17@tut.by тел.+375447584780

- 1 pole 6 A, 1 CO or 1 NO contact
- Only 5 mm wide
- Sensitive coil 170 mW
- 4 kV coil-contact, 6 / 8 mm clearance/creepage, NO version with 8 / 8 mm clearance/creepage on request
- Reinforced insulation (protection class II)
- Allows high function-/packing density
- Cadmium-free contacts, AgNi 90/10 for AC-loads
- RoHS compliant (Directive 2002/95/EC) as per product date code 0404

Applications: centralized and decentralized heating control, extremely narrow interface elements, interface technology, timers, PLC's, I/O modules, I/O-ports



F0140-C

Approvals

VDE REG.-Nr. 6666, CE, UL E214024
 Technical data of approved types on request

Contact data

Contact configuration	1CO or 1NO		
Contact set	single contact		
Type of interruption	micro disconnection		
Rated current	6 A		
Rated voltage / max.switching voltage AC	240/400 VAC		
Maximum breaking capacity AC	1500 VA		
Limiting making capacity, max 4 s, duty factor 10%	10 A		
Contact material	AgSnO ₂	AgSnO ₂ gold plated	AgNi90/10
Minimum contact load	100mA, 12V	50mW	100mA, 12V
Mechanical endurance	10x10 ⁶ cycles		
Rated frequency of operation with / without load	6 / 1200 min ⁻¹		

Contact ratings

Type	Load	Cycles
V23092-****-A302	3(1,5)A, 250VAC, 85°C, 1mm mounting distance, 6 cycles / min, EN60730-1	100x10 ³
V23092-****-A302	5(1,5)A, 250VAC, 85°C, 0,5mm mounting distance, 6 cycles / min, EN60730-1	10x10 ³
V23092-	Pilot Duty R300 28 VDC, 85°C, 6000 cycles, UL508	
V23092-	Pilot Duty B300 240 VAC, 85°C, 6000 cycles, UL508	

Coil data

Rated coil voltage range DC coil	5...60 VDC
Coil power DC coil	typ. 170 mW
Operative range	2

Coil versions, DC-coil

Coil code	Rated voltage VDC	Operate voltage VDC	Release voltage VDC	Coil resistance Ohm	Rated coil power mW
005	5	3.5	0.25	147 ± 10%	170
012	12	8.4	0.6	848 ± 10%	170
024	24	16.8	1.2	3390 ± 10%	170
048	48	33.6	2.4	10600 ± 15%	217

All figures are given for coil without preenergization, at ambient temperature +23°C
 Other coil voltages on request

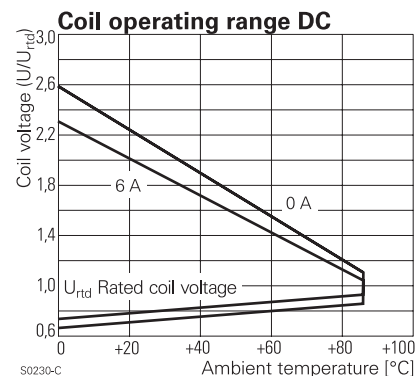
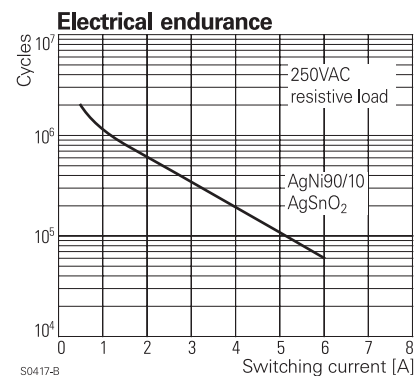
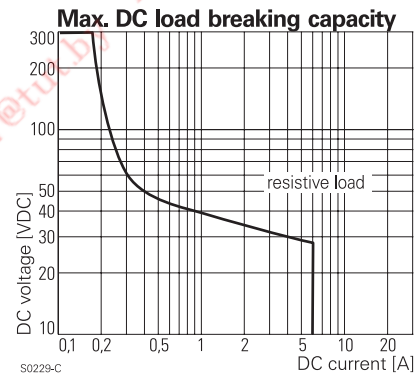

Insulation

Dielectric strength coil-contact circuit	4000 V _{rms}
open contact circuit	1000 V _{rms}
Clearance / creepage coil-contact circuit	≥ 6 / 8 mm
Material group of insulation parts	IIIa
Tracking index of relay base	PTI 250
Insulation to IEC 60664-1	
Type of insulation coil-contact circuit	reinforced
open contact circuit	functional
Rated insulation voltage	250 V
Pollution degree	3
Rated voltage system	230 V
Overvoltage category	III

PCB layout / terminal assignment

Bottom view on solder pins

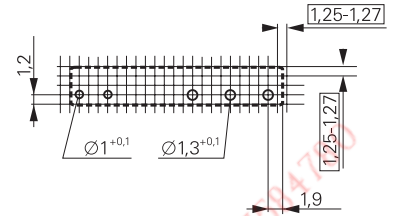

S0258-AA

Other data

RoHS - Directive 2002/95/EC	compliant as per product data code 0404
Flammability class according to UL94	V-0
Ambient temperature range	-40...+85°C
Operate- / release time	5 / 2,5 ms
Bounce time NO / NC contact	1,5 / 5 ms
Vibration resistance (function) NO / NC contact	10 / 5 g
Shock resistance (function) NO / NC contact	10 / 5 g
Shock resistance (destruction)	30 g
Category of protection	RTIII - wash tight
Mounting	pcb
Mounting position	any
Minimum mounting distance	0 mm
Resistance to soldering heat	260°C / 5 s
Relay weight	6 g
Packaging unit	20 / 1000 pcs

1 CO contact

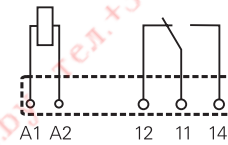

S0258-AB

1 NO contact

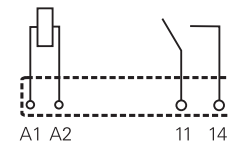

S0258-AC

Accessories

For details see datasheet Accessories SNR

Dimensions

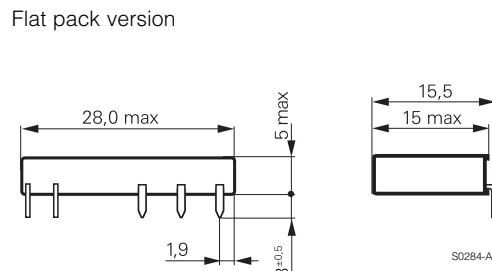
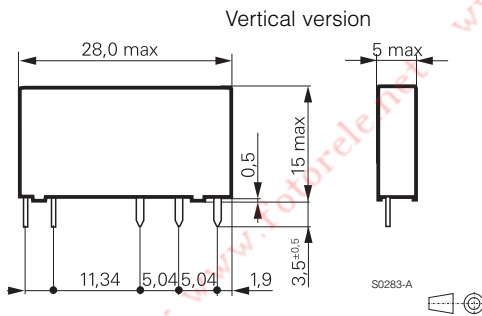

Product key

V 2 3 0 9 2 - 1 - A

Type

Version

A PCB vertical version **B** PCB flat pack version

Version

1 wash tight

Coil

Coil code: please refer to coil versions table

Contact system

A standard

Contact material

2 AgSnO₂, gold plated **3** AgSnO₂
8 AgNi 90/10

Contact configuration

01 1 CO contact **02** 1 NO contact

NO version with 8/8 mm clearance and creepage and other types on request

Product key	Version	Contacts	Contact material	Coil	Part number
V23092-A1005-A201	PCB	1 CO contact	AgSnO ₂ , gold pl.	5 VDC	0-1393236-1
V23092-A1005-A202	vertical version	1 NO contact			8-1415067-1
V23092-A1005-A301	wash tight	1 CO contact	AgSnO ₂		0-1393236-2
V23092-A1005-A302		1 NO contact			9-1415067-1
V23092-A1005-A801		1 CO contact	AgNi 90/10		1-1415068-1
V23092-A1005-A802		1 NO contact			0-1415068-1
V23092-A1012-A201		1 CO contact	AgSnO ₂ , gold pl.	12 VDC	0-1393236-4
V23092-A1012-A202		1 NO contact			0-1393236-5
V23092-A1012-A301		1 CO contact	AgSnO ₂		0-1393236-7
V23092-A1012-A302		1 NO contact			0-1393236-8
V23092-A1012-A801		1 CO contact	AgNi 90/10		1-1393236-3
V23092-A1012-A802		1 NO contact			2-1415068-1
V23092-A1024-A201		1 CO contact	AgSnO ₂ , gold pl.	24 VDC	2-1393236-1
V23092-A1024-A202		1 NO contact			2-1393236-2
V23092-A1024-A301		1 CO contact	AgSnO ₂		2-1393236-4
V23092-A1024-A302		1 NO contact			2-1393236-5
V23092-A1024-A801		1 CO contact	AgNi 90/10		3-1393236-0
V23092-A1024-A802		1 NO contact			5-1415063-1
V23092-A1048-A201		1 CO contact	AgSnO ₂ , gold pl.	48 VDC	3-1393236-5
V23092-A1048-A202		1 NO contact			3-1393236-6
V23092-A1048-A301		1 CO contact	AgSnO ₂		3-1393236-7
V23092-A1048-A302		1 NO contact			3-1393236-8
V23092-A1048-A801		1 CO contact	AgNi 90/10		3-1393236-9
V23092-A1048-A802		1 NO contact			3-1415068-1

Реле Finder Минск т.80447584780

www.fotorele.net www.tiristor.by

email minsk17@tut.by tel.+375 29 758 47 80 МТС

каталог, описание, finder, реле, технические, характеристики, datasheet, параметры, маркировка, габариты, фото, даташит, аналог, замена, Беларусь

Реле, каталог, описание, технические, характеристики, datasheet, параметры, маркировка, габариты, фото, даташит, *finder, финдер*



г. Минск www.fotorele.net www.tiristor.by email minsk17@tut.by тел.+375447584780

реле

реле электромеханическое

электронные компоненты

где и как купить в Минске?